



**YAMAHA**



**2009 WaveRunner  
FX SHO  
FX Cruiser SHO**

**OWNER'S/OPERATOR'S MANUAL**

**▲ Read this manual carefully  
before operating this watercraft.**

---

**YAMAHA MOTOR CO., LTD.**  
F1W-F8199-71-E0

**Read this manual carefully before operating this watercraft. This manual should stay with the WaveRunner if it is sold.**

# Important manual information

---

EJU37151

## Declaration of Conformity for Personal Watercraft (PWC) with the requirements of Directive 94/25/EC as amended by Directive 2003/44/EC

Revision No:

**Name of PWC manufacturer:**

YAMAHA MOTOR CO., LTD.

---

**Address:** 2500 Shingai

---

**Town:** Iwata, Shizuoka **Post Code:** 438-8501

---

**Country:** Japan

---

**Name of Authorized Representative** (if applicable):

YAMAHA MOTOR EUROPE N.V.

---

**Address:** Koolhovenlaan 101

---

**Town:** Schiphol-Rijk **Post Code:** 1119 NC

---

**Country:** The Netherlands

---

**Name of Notified Body for noise emission assessment:** Luxcontrol SA

---

**Address:** 1, avenue des Terres Rouges BP 349

---

**Town:** Esch-sur-Alzette **Post Code:** L-4004

---

**Country:** Luxembourg **ID Number:** 0882

---

**Name of Notified Body for exhaust emission assessment:** Luxcontrol SA

---

**Address:** 1, avenue des Terres Rouges BP 349

---

**Town:** Esch-sur-Alzette **Post Code:** L-4004

---

**Country:** Luxembourg **ID Number:** 0882

---

**ECtype-examination Certificate number** (if applicable): LC\*2003/44\*10026

---

# Important manual information

## Conformity assessment modules used:

for construction: A  Aa  B+C  B+D  B+E  B+F  G  H

for noise emissions: Aa  G  H

for exhaust emissions: B+C  B+D  B+E  B+F  G  H

## Other Community Directives applied:

**Directive 89/336/EEC relating to electromagnetic compatibility (EMC), using the following standards, for emission CISPR12:2001, for generic immunity EN61000-6-2:2001**

## DESCRIPTION OF CRAFT

Craft model Identification Number, starting from

U S - Y A M A 1 0 8 1 G 8 0 9 -

Model name / Commercial name :

Design Category:  C  D

**FX1800A-H / FX Cruiser SHO, FX1800-H / FX SHO**

## IDENTIFICATION OF ENGINE(S) COVERED BY THIS DECLARATION OF CONFORMITY

Combustion cycle:  2 stroke  4 stroke

Unique engine identification number(s) or engine family code(s)	EC Type-examination certificate (for exhaust)
6S5	LC*2003/44*10026

ESSENTIAL REQUIREMENTS	standards	other normative document/method	technical file	Please specify in more detail (* = mandatory standard)
I.A design and construction	<input checked="" type="checkbox"/>	<input type="checkbox"/>	<input checked="" type="checkbox"/>	EN ISO 13590
I.B exhaust emissions	<input checked="" type="checkbox"/> *	<input type="checkbox"/>	<input checked="" type="checkbox"/>	*EN ISO 8178-1:1996
I.C noise emissions	<input checked="" type="checkbox"/> *	<input type="checkbox"/>	<input checked="" type="checkbox"/>	*EN ISO 14509

This declaration of conformity is issued under the sole responsibility of the PWC manufacturer. I declare on behalf of the PWC manufacturer that the craft model and engine(s) mentioned above comply with all applicable essential requirements in the way specified and are in conformity with the type for which above mentioned EC type-examination certificate(s) has(have) been issued.

**Name / title:** S. Hayakawa / President of YAMAHA MOTOR EUROPE N.V.

(identification of the person empowered to sign on behalf of the PWC manufacturer or his authorized representative)

Signature: \_\_\_\_\_

(or an equivalent marking)



**Date and place of issue:** 1st / June / 2008, Schiphol-Rijk, The Netherlands

# Important manual information

---

EJU30191

## To the owner/operator

Thank you for choosing a Yamaha watercraft. This owner's/operator's manual contains information you will need for proper operation, maintenance, and care. If you have any questions about the operation or maintenance of your watercraft, please consult a Yamaha dealer.

This manual is not a course on boating safety or seamanship. If this is your first watercraft, or if you are changing to a type of watercraft you are not familiar with, for your own comfort and safety, please ensure that you obtain proper training or practice before operating the watercraft by yourself. In addition, a Yamaha dealer or boating organization will be pleased to recommend local sea schools, or competent instructors.

Because Yamaha has a policy of continuing product improvement, this product may not be exactly as described in this owner's/operator's manual. Specifications are subject to change without notice.

This manual should be considered a permanent part of this watercraft and should remain with it even if the watercraft is subsequently sold.

In this manual, information of particular importance is distinguished in the following ways:



The Safety Alert Symbol means ATTENTION! BECOME ALERT! YOUR SAFETY IS INVOLVED!

EWJ00071

## WARNING

A WARNING indicates a hazardous situation which, if not avoided, could result in death or serious injury.

---

ECJ00091

## NOTICE

A NOTICE indicates special precautions that must be taken to avoid damage to the watercraft or other property.

---

## TIP:

A TIP provides key information to make procedures easier or clearer.

EJU30231

**WaveRunner FX SHO/FX Cruiser SHO  
OWNER'S/OPERATOR'S MANUAL  
©2008 by Yamaha Motor Co., Ltd.  
1st Edition, May 2008  
All rights reserved.  
Any reprinting or unauthorized use  
without the written permission of  
Yamaha Motor Co., Ltd.  
is expressly prohibited.  
Printed in U.S.A.**

# Table of contents

---

<b>General and important labels</b> .....	<b>1</b>	Quick Shift Trim System (QSTS)	
Identification numbers .....	1	selector .....	31
Primary Identification (PRI-ID)		Handgrip .....	33
number .....	1	Reboarding step .....	33
Craft Identification Number (CIN) .....	1	Bow eye .....	33
Engine serial number .....	1	Stern eyes .....	34
Model information .....	2	Pull-up cleats	
Builder's plate .....	2	(for FX Cruiser SHO) .....	34
Important labels .....	3	Yamaha Engine Management	
Warning labels .....	4	System (YEMS) .....	34
Other labels .....	8	Yamaha Security System .....	34
<b>Safety information</b> .....	<b>10</b>	No-wake mode .....	36
Limitations on who may operate		Cruise assist .....	37
the watercraft .....	10	Multifunction information center .....	39
Cruising limitations .....	11	Storage compartments .....	49
Operation requirements .....	12	<b>Operation</b> .....	<b>52</b>
Recommended equipment .....	14	Fuel and oil .....	52
Hazard information .....	15	Fuel .....	52
Watercraft characteristics .....	15	Engine oil .....	53
Water-skiing .....	17	Pre-operation checks .....	54
Safe boating rules .....	19	Pre-operation check list .....	54
Enjoy your watercraft		Pre-operation check points .....	56
responsibly .....	19	Operation .....	64
<b>Features and functions</b> .....	<b>21</b>	Engine break-in .....	64
Location of main components .....	21	Launching the watercraft .....	64
Operation of controls and other		Starting the engine .....	64
functions .....	25	Stopping the engine .....	65
Seats .....	25	Shifting .....	66
Hood .....	26	Leaving the watercraft .....	66
Fuel tank filler cap .....	26	Operating your watercraft .....	67
Remote control transmitter .....	26	Getting to know your watercraft .....	67
Engine stop switch .....	27	Learning to operate your	
Engine shut-off switch .....	27	watercraft .....	67
Start switch .....	28	Riding with passengers .....	68
Right handlebar switches .....	28	Starting the watercraft .....	68
Throttle lever .....	29	Boarding and starting in deep	
Cooling water pilot outlets .....	29	water .....	69
Steering system .....	30	Capsized watercraft .....	72
Tilt lever .....	30	Turning the watercraft .....	73
Shift lever .....	31	Stopping the watercraft .....	74
		Beaching the watercraft .....	75
		Docking the watercraft .....	75
		Reverse on waterways .....	75

# Table of contents

---

Operating in weeded areas .....	76
Post-operation care .....	76
Transporting .....	77
<b>Maintenance and care.....</b>	<b>78</b>
Storage .....	78
Flushing the cooling system .....	78
Lubrication .....	79
Battery .....	79
Cleaning the watercraft .....	79
<b>Maintenance and adjustments .....</b>	<b>80</b>
Owner's/operator's manual and tool kit .....	80
Periodic maintenance chart .....	81
Checking the fuel system .....	83
Engine oil and oil filter .....	83
Air filter element .....	83
Checking the jet thrust nozzle angle .....	83
Checking the shift cable .....	84
Checking and adjusting the throttle cable .....	84
Cleaning and adjusting the spark plugs .....	86
Lubrication points .....	87
Checking the battery .....	89
Fuel injection system .....	90
<b>Specifications .....</b>	<b>91</b>
Specifications .....	91
<b>Trouble recovery .....</b>	<b>92</b>
Troubleshooting .....	92
Troubleshooting chart .....	92
<b>Emergency procedures .....</b>	<b>95</b>
Cleaning the jet intake and impeller .....	95
Jumping the battery .....	96
Replacing the fuses .....	96
Towing the watercraft .....	98
Submerged watercraft .....	98

# General and important labels

EJU36450

## Identification numbers

Record the Primary Identification (PRI-ID) number, Craft Identification Number (CIN), and engine serial number in the spaces provided for assistance when ordering spare parts from a Yamaha dealer. Also record and keep these ID numbers in a separate place in case your watercraft is stolen.

EJU30281

### Primary Identification (PRI-ID) number

The PRI-ID number is stamped on a plate attached inside the engine compartment.

#### MODEL:

FX1800-H (FX SHO)

FX1800A-H (FX Cruiser SHO)

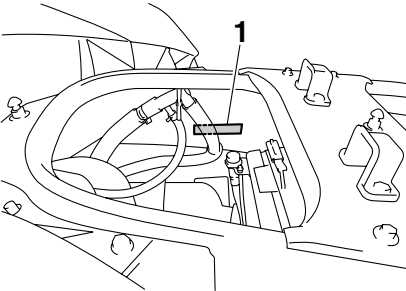

1 Primary Identification (PRI-ID) number location

MODEL	<input type="text"/>	PRI-ID.	<input type="text"/>
YAMAHA MOTOR CO., LTD.		F1W	
ASSEMBLED IN U.S.A. FROM AMERICAN AND JAPANESE COMPONENTS.			
ASSEMBLÉ AUX ÉTATS-UNIS DE PIÈCES AMÉRICAINES ET JAPONAISES.			

F 1 W -

EJU36550

### Craft Identification Number (CIN)

The CIN is stamped on a plate attached to the aft deck.

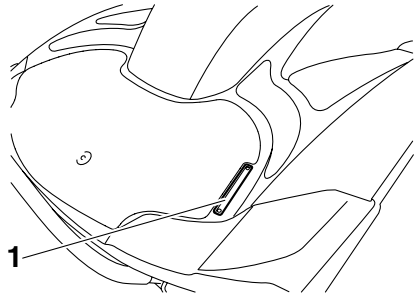

1 Craft Identification Number (CIN) location

US - YAM

EJU30310

### Engine serial number

The engine serial number is stamped on a plate attached to the engine unit.

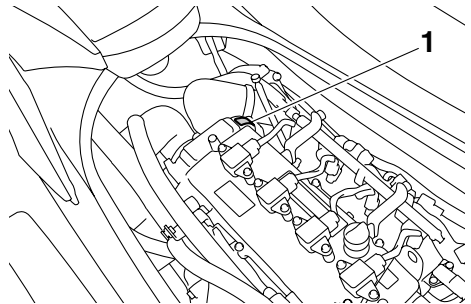

1 Engine serial number location

<b>YAMAHA</b>	<input type="text"/>
<input type="text"/> <input type="text"/> <input type="text"/> <input type="text"/>	<input type="text"/>
YAMAHA MOTOR CO., LTD.	
MADE IN JAPAN	
PAYS D'ORIGINE JAPON	



# General and important labels

EJU30320

## Model information

EJU30331

### Builder's plate

Watercraft with this label conform to certain portions of the European Parliament directive relating to machinery.

Part of the information is given on the builder's plate affixed on the craft. A full explanation of this information is given in the relevant sections of this manual.

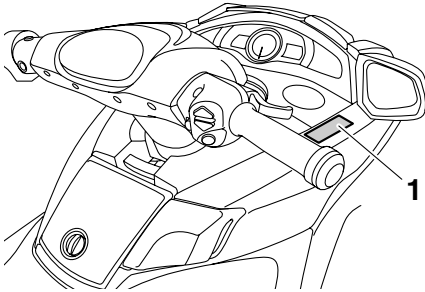

1 Builder's plate location

### TIP:

The significant wave height is the mean height of the highest one-third of the waves, which approximately corresponds to the wave height estimated by an experienced observer. However, some waves will be double this height.

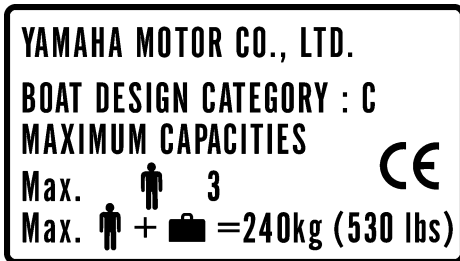

**Design category of this personal watercraft: C**

### Category C:

This watercraft is designed to operate in winds up to Beaufort force 6 and the associated wave heights (significant wave heights up to 2 m (6.56 ft); see the following TIP). Such conditions may be encountered in exposed inland waters, in estuaries, and in coastal waters in moderate weather conditions.

# General and important labels

EJU30451

## Important labels

Read the following labels before operating this watercraft. If you need any additional information, contact a Yamaha dealer.

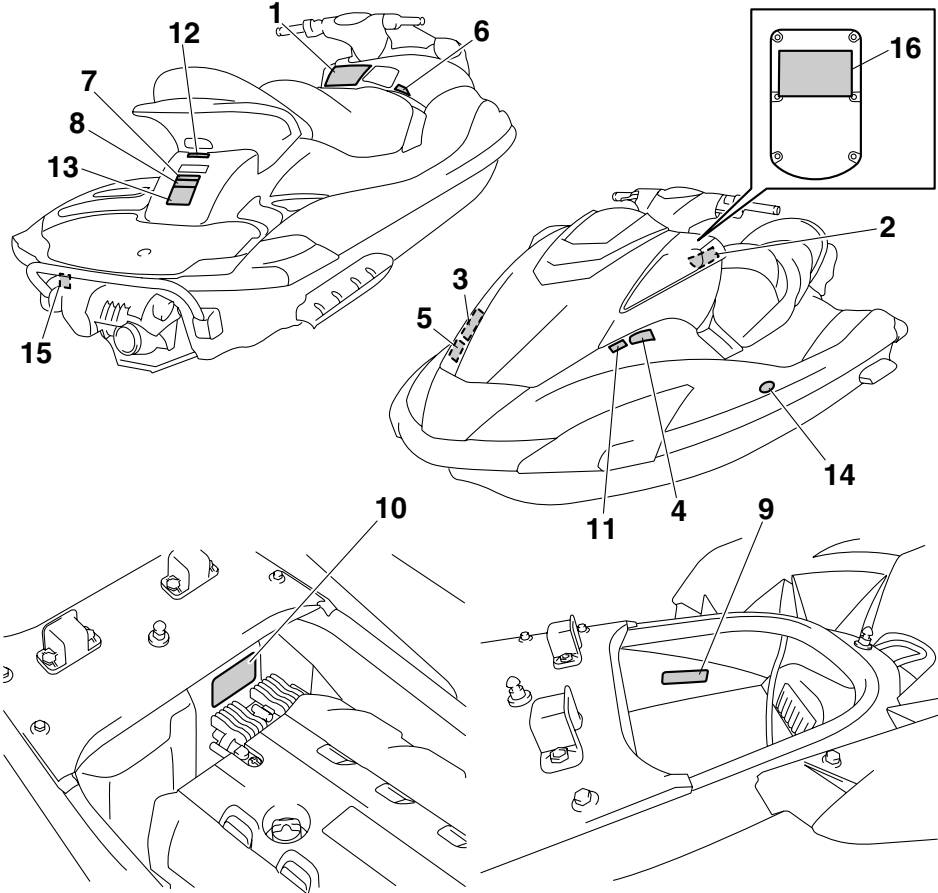

# General and important labels

EJU35911

## Warning labels

If any of these labels are damaged or missing, contact a Yamaha dealer for replacements.

1

**⚠ WARNING**

To reduce the risk of SEVERE INJURY or DEATH:

**WEAR A PERSONAL FLOTATION DEVICE (PFD).**  
All riders must wear an authority-approved PFD that is suitable for personal watercraft (PWC) use.

**WEAR PROTECTIVE CLOTHING.** Severe internal injuries can occur if water is forced into body cavities as a result of falling into water or being near jet thrust nozzle. Normal swimwear does not adequately protect against forceful water entry into rectum or vagina. All riders must wear a wet suit bottom or clothing that provides equivalent protection (See Owner's Manual).

Footwear, gloves, and goggles/glasses are recommended.

**KNOW BOATING LAWS.** Yamaha Motor Co., Ltd. recommends a minimum operator age of 16 years old. Know the operator age and training requirements for your state. A boating safety course is recommended and may be required in your state.

**ATTACH ENGINE SHUT-OFF CORD (LANYARD)** to wrist and keep it free from handlebars so that engine stops if operator falls off. After riding, remove cord from PWC to avoid unauthorized use by children or others.

**RIDE WITHIN YOUR LIMITS AND AVOID AGGRESSIVE MANEUVERS** to reduce the risk of loss of control, ejection, and collision. This is a high performance boat – not a toy. Sharp turns or jumping wakes or waves can increase the risk of back/spinal injury (paralysis), facial injuries, and broken legs, ankles, and other bones.  
Do not jump wakes or waves.

**DO NOT APPLY THROTTLE WHEN ANYONE IS AT REAR OF PWC**—turn engine off or keep engine at idle. Water and/or debris exiting jet thrust nozzle can cause severe injury.

**⚠ WARNING**

KEEP AWAY FROM INTAKE GRATE while engine is on. Items such as long hair, loose clothing, or PFD straps can become entangled in moving parts resulting in severe injury or drowning.

NEVER RIDE AFTER CONSUMING DRUGS OR ALCOHOL





Collisions result in more INJURIES AND DEATHS than any other type of accident for personal watercraft (PWC).  
**TO AVOID COLLISIONS:**  
SCAN CONSTANTLY for people, objects, and other watercraft. Be alert for conditions that limit your visibility or block your vision of others.  
**OPERATE DEFENSIVELY** at safe speeds and keep a safe distance away from people, objects, and other watercraft.

- Do not follow directly behind PWCs or other boats.
- Do not go near others to spray or splash them with water.
- Avoid sharp turns or other maneuvers that make it hard for others to avoid you or understand where you are going.
- Avoid areas with submerged objects or shallow water.

**DO NOT RELEASE THROTTLE WHEN TRYING TO STEER** away from objects – you need throttle to steer. Always check throttle and steering controls for proper operation before starting PWC. Follow navigation rules and state/province and local laws that apply to PWCs. See Owner's Manual for more information.

READ AND FOLLOW OWNER'S MANUAL  
YAMAHA

F1W-U41B1-10



4

# General and important labels

2

## ⚠ AVERTISSEMENT

Afin de limiter les risques de BLESSURES GRAVES, voire MORTELLES: PORTER UN GILET DE SAUVETAGE. Tout utilisateur doit porter un gilet de sauvetage homologué pour les scooters des mers. PORTER DES VÊTEMENTS PROTÉCTEURS. Le choc infligé par la pénétration forcée d'eau dans les orifices corporels lors d'une chute ou lors du contact avec le jet d'eau de la pompe risque de provoquer des lésions graves. Le port d'un simple maillot de bain ne constitue pas une protection adéquate contre la puissance de pénétration de l'eau dans le rectum et/ou le vagin. Tout utilisateur doit porter le pantalon d'une tenue de plongée ou tout autre vêtement offrant une protection semblable. (Voir le manuel d'utilisation.) Le port de chaussures, de gants et de lunettes de plongée est recommandé. CONNAÎTRE LES LOIS DE NAVIGATION. La Yamaha Motor Co., Ltd. recommande la limite d'âge de pilotage de 16 ans. Vérifier l'âge du pilote ainsi que les exigences quant à l'âge prévues par la législation locale. Il est préférable, et parfois requis par certaines législations, de suivre un cours de sécurité maritime. ATTACHER LA LANIÈRE DE L'INTERRUPTEUR D'ARRÊT DU MOTEUR au poignet et l'éloigner du guidon afin que le moteur se coupe bien en cas de chute. Après utilisation, retirer la lanière du scooter afin de prévenir toute utilisation par des enfants ou des personnes non-autorisées.



YAMAHA

F1B-U41B1-21

3

## ⚠ AVERTISSEMENT

Afin de limiter les risques de BLESSURES GRAVES, voire MORTELLES:

RESPECTER SES LIMITES ET ÉVITER LES MANOEUVRES BRUTALES afin de limiter tout risque de perte de contrôle, d'éjection et de collision. Il s'agit d'un véhicule à hautes performances et pas d'un jouet. Des virées brusques ou le saut de sillages ou de vagues accroît le risque de blessures au dos, voire de paralysie, de blessures au visage et de fractures diverses. **Ne jamais sauter des sillages ni des vagues.**

NE PAS DONNER DES GAZ LORSQUE QUELQU'UN SE TROUVE DERRIÈRE LE VÉHICULE: couper le moteur ou laisser tourner au ralenti. Eau et/ou débris projetés par la pompe pourraient causer des blessures graves. NE PAS S'APPROCHER DE LA GRILLE D'ADMISSION lorsque le moteur tourne. Cheveux longs, vêtements amples ou lanières de gilet de sauvetage risquent d'être happés, ce qui pourrait provoquer des blessures, ou même une noyade.

NE JAMAIS PILOTER APRÈS AVOIR ABSORBÉ DE L'ALCOOL, DES DROGUES OU CERTAINS MÉDICAMENTS.

LIRE ET RESPECTER LES INSTRUCTIONS DONNÉES DANS LE MANUEL D'UTILISATION.

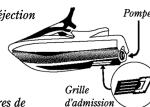

YAMAHA

F1B-U41B1-31

4

## ⚠ AVERTISSEMENT

Les collisions sont la cause principale des BLESSURES ET DÉCÈS

d'utilisateurs de scooter des mers. POUR ÉVITER LES

COLLISIONS: ÊTRE CONSTAMMENT à l'affût de

personnes, d'objets et d'autres bateaux. Être conscient des

conditions limitant sa visibilité ou celle des autres embarcations.

PILOTER AVEC PRUDENCE à des vitesses raisonnables

et garder une distance de sécurité entre le scooter et toute personne, objet et embarcation.

• Ne pas suivre une autre embarcation de trop près.

• Ne pas se rapprocher d'autrui en vue de l'éclabousser

• Éviter les virages brusques ou toute manoeuvre qui risque de mettre un autre pilote

en danger ou qui l'empêche de pouvoir déterminer clairement la direction que l'on prend.

• Éviter les endroits où flottent des objets et les eaux peu profondes.

REAGIR RAPIDEMENT en vue d'éviter les collisions. Garder à l'esprit que les

bateaux n'ont pas de freins.

NE PAS LÂCHER LES GAZ LORSQUE L'ON ESSAYE DE S'ÉLOIGNER

d'objets-une poussée est nécessaire à la direction du scooter des mers. Toujours

s'assurer avant le départ que l'accélérateur et la direction fonctionnent

correctement. Suivre les lois de navigation ainsi que les législations nationales,

provinciales et locales concernant les scooters des mers.

Voir le manuel d'utilisation pour plus

d'informations.

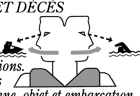

YAMAHA

F1B-U41B2-01

5

# General and important labels

5

<b>⚠ WARNING</b>	<b>⚠ AVERTISSEMENT</b>
<p>Gasoline is highly flammable and explosive. A fire or explosion could cause severe injury or death. Shut engine off. Refuel in well ventilated area away from flames or sparks. Do not smoke. Avoid spilling gasoline. Wipe up spilled gasoline immediately. Remove all seats to ventilate fuel vapors from engine compartment before starting engine. Do not start engine if there is a fuel leak or a loose electrical connection.</p>	<p><i>L'essence est très inflammable et explosible. Un incendie ou une explosion risquent de provoquer des blessures graves, voire mortelles. Couper le moteur. Faire le plein dans un endroit bien aéré et éloigné de toute flamme ou étincelle. Ne pas fumer. Éviter de renverser de l'essence. Essayer immédiatement toute coulure d'essence. Déposer les selles pour évacuer les vapeurs d'essence du compartiment du moteur avant de mettre le moteur en marche. Ne jamais mettre le moteur en marche en cas de fuite d'essence ou si un branchement électrique est desserré.</i></p>
<b>REGULAR UNLEADED GASOLINE ONLY</b>	<b>ESSENCE NORMALE SANS PLOMB UNIQUEMENT</b>

F1S-U415B-11

6

<b>⚠ WARNING</b>
REVERSE SHIFT LEVER OPERATION:
<ul style="list-style-type: none"><li>• Shift only while engine is idling or off.</li><li>• Reverse is for low speed maneuvering only.</li><li>• Do not use reverse function to slow down or stop PWC as it could cause you to lose control, be ejected, or impact handlebars.</li><li>• Make sure that there are no obstacles or people behind you before shifting to reverse.</li></ul>
<b>⚠ AVERTISSEMENT</b>
FONCTIONNEMENT DU LEVIER D'INVERSION DE MARCHÉ:
<ul style="list-style-type: none"><li>• Inverser la marche uniquement lorsque le moteur tourne au ralenti ou lorsqu'il est coupé.</li><li>• La marche arrière est destinée exclusivement aux manœuvres à vitesse réduite.</li><li>• Ne pas sélectionner la marche arrière en vue de ralentir ou d'arrêter le scooter des mers, car il y a risque de perte de contrôle, d'éjection ou de heurt sur le guidon.</li><li>• S'assurer qu'il n'y a ni obstacle ni personne derrière le scooter avant d'engager la marche arrière.</li></ul>

F0V-U41D5-31

7

<b>⚠ WARNING</b>
<p>Do not use cleat or grips to lift PWC. PWC could fall, which could result in severe injury.</p>
<b>⚠ AVERTISSEMENT</b>
<p>Ne pas soulever le scooter à l'aide du taquet ou des poignées. Le scooter pourrait tomber et provoquer des blessures graves.</p>

(F1S-U41E1-11)

8

<b>⚠ WARNING</b>
<ul style="list-style-type: none"><li>• Severe internal injuries can occur if water is forced into body cavities as a result of being near jet thrust nozzle.</li><li>• Wear a wetsuit bottom or clothing that provides equivalent protection.</li><li>• Do not board PWC if operator is applying throttle.</li></ul>
<b>⚠ AVERTISSEMENT</b>
<ul style="list-style-type: none"><li>• Le choc infligé par la pénétration forcée d'eau dans les orifices corporels lors du contact avec le jet de la pompe risque de provoquer des lésions graves.</li><li>• Porter le pantalon d'une tenue de plongée ou tout autre vêtement offrant une protection semblable.</li><li>• Ne pas embarquer lorsque la pilote donne des gaz.</li></ul>

(F1S-U41E1-11)

# General and important labels

9

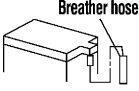
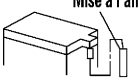
<b>⚠ WARNING</b>	
Be sure to connect breather hose to battery. Fire or explosion could result if not connected properly.	
<b>⚠ AVERTISSEMENT</b>	
Bien veiller à brancher la durit de mise à l'air à la batterie. Un mauvais branchement risque d'être à l'origine d'un incendie ou d'une explosion.	
<small>YAMAHA</small>	

F0V-U41DB-12

10

<b>⚠ WARNING / AVERTISSEMENT / 警告</b>	
<b>Do not touch or remove electrical parts when starting or running the engine.</b>	
<b>Ne pas toucher ou retirer les pièces électriques lors du démarrage ou de la marche du moteur.</b>	
運転中は電装品には触らないでください。	
<small>YAMAHA</small>	<small>6B6-63623-00</small>

11

<b>⚠ AVERTISSEMENT</b>	
<b>APPLICABLE POUR LA FRANCE SEULEMENT</b>	
<ul style="list-style-type: none"><li>• <i>En France : permis de conduire et immatriculation obligatoire.</i></li><li>• <i>Navigation en mer autorisée entre 300 mètres et 2 milles nautique.</i></li><li>• <i>Entre 0 et 300 mètres, se référer aux instructions nautiques locales affichées. Sinon, règle générale : vitesse maxi 5 noeuds (9Km/h) dans cette zone.</i></li><li>• <i>Utiliser les chenaux obligatoires de sortie lorsqu'ils existent.</i></li><li>• <i>Respecter les règles de priorité.</i></li><li>• <i>Gilet de sauvetage obligatoire-Fusée et bout de remorquage à bord.</i></li><li>• <i>Ne jamais conduire sous l'influence de l'alcool ou de drogues.</i></li><li>• <i>Consulter la météo avant de sortir en mer.</i></li><li>• <i>Une conduite responsable et un contrôle quotidien de votre machine suivant le manuel d'entretien YAMAHA seront garants de votre sécurité.</i></li></ul>	
<small>YAMAHA</small>	<small>GPB-U416H-01</small>

# General and important labels

EJU36261

## Other labels

12

**FIRE EXTINGUISHER CONTAINER  
COMPARTIMENT DE L'EXTINCTEUR**

F1B-U41F5-21

13

**RATED PERSON CAPACITY: 3  
MAXIMUM LOAD: 240 kg (530 lb)  
CAPACITÉ MAXIMALE: 3 personnes  
CHARGE MAXIMALE: 240 kg(530 lb)**

(F1S-U41E1-11)

14



The following label indicates the correct direction to upright a capsized watercraft.

15

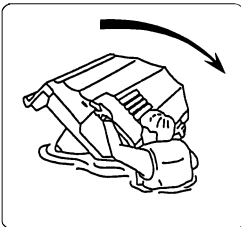

F1G-U41B-00

# General and important labels

---

The following CE marking is located on the back of the remote control transmitter.

16

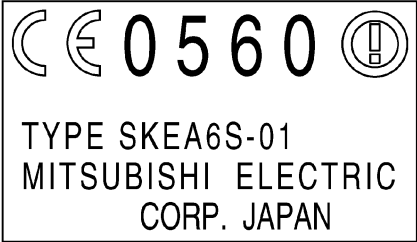



EJU30682

The safe use and operation of this watercraft is dependent upon the use of proper riding techniques, as well as upon the common sense, good judgment, and expertise of the operator. Before using this watercraft, make sure that its use is permitted under local laws, bylaws, and regulations, and always operate the watercraft in full conformity with any requirements and limitations imposed. Every operator should know the following requirements before riding the watercraft.

- Before operating the watercraft, read this owner's/operator's manual, the Riding Practice Guide, the Riding Instruction card, and all labels on the watercraft. These materials should give you an understanding of the watercraft and its operation.
- Never allow anyone to operate this watercraft until they too have read this owner's/operator's manual, the Riding Practice Guide, the Riding Instruction card, and all labels.

EJU30740

## Limitations on who may operate the watercraft

- Yamaha recommends a minimum operator age of 16 years old. Adults must supervise use by minors. Know your local operator age and training requirements.
- This watercraft is designed to carry the operator and up to 2 passengers. Never exceed the maximum load limit or allow more than 3 persons (or 2 persons if a water-skier is being pulled) to ride the watercraft at any time.



Maximum load:  
240 kg (530 lb)  
Load is the total weight of cargo, operator, and passengers.

- Do not operate the watercraft with any passengers on board until you have considerable practice and experience riding alone. Operating the watercraft with passengers requires more skill. Take the time to become accustomed to the handling characteristics of the watercraft before trying any difficult maneuvers.

# Safety information

EJU30761

## Cruising limitations

- Scan constantly for people, objects, and other watercraft. Be alert for conditions that limit your visibility or block your vision of others.

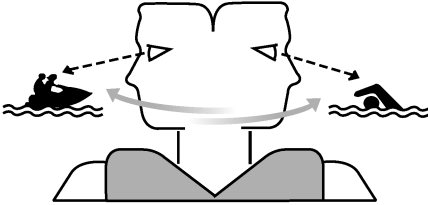

- Operate defensively at safe speeds and keep a safe distance away from people, objects, and other watercraft.
- Do not follow directly behind watercraft or other boats.
- Do not go near others to spray or splash them with water.
- Avoid sharp turns or other maneuvers that make it hard for others to avoid you or understand where you are going.
- Avoid areas with submerged objects or shallow water.
- Take early action to avoid collisions. Remember, watercraft and other boats do not have brakes.
- Do not release the throttle lever when trying to steer away from objects—you need throttle to steer. Always check throttle and steering controls before starting the watercraft.
- Ride within your limits and avoid aggressive maneuvers to reduce the risk of loss of control, ejection, and collision.
- This is a high performance boat—not a toy. Sharp turns or jumping wakes or waves can increase the risk of back/spinal injury (paralysis), facial injuries, and broken legs, an-

cles, and other bones. Do not jump wakes or waves.

- Do not operate the watercraft in rough water, bad weather, or when visibility is poor; this may lead to an accident causing injury or death. Be alert to the possibility of adverse weather. Take note of weather forecasts and the prevailing weather conditions before setting out on your watercraft.
- As with any water sport, you should not operate your watercraft without someone else nearby. If you operate further than swimming distance from shore, you should be accompanied by another boat or watercraft, but make sure you stay a safe distance away. It's good, common sense.
- Never operate in water that is less than 60 cm (2 ft) deep from the bottom of the watercraft, otherwise you increase your chance of hitting a submerged object, which could result in injury.

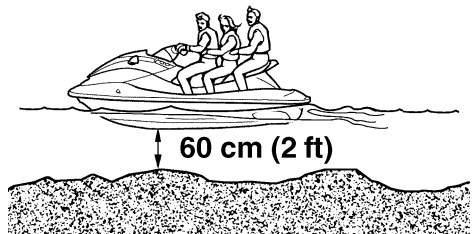

- This watercraft is not equipped with lighting required for night operation. Do not operate the watercraft after sunset or before dawn, otherwise you increase the risk of colliding

with another boat, which could result in severe injury or death.



- Follow navigation rules, and state/provincial and local laws that apply to watercraft.

EJU30821

## Operation requirements

- All riders must wear a personal flotation device (PFD) that is approved by the appropriate authorities and is suitable for personal watercraft use.
- Wear protective clothing. Severe internal injuries can occur if water is forced into body cavities as a result of falling into the water or being near the jet thrust nozzle. Normal swimwear does not adequately protect against forceful water entry into the rectum or vagina. All riders must wear a wetsuit bottom or clothing that provides equivalent protection. Such clothing includes thick, tightly woven, sturdy and snug-fitting apparel such as denim, but does not include spandex or similar fabrics, like those used in bicycle shorts.

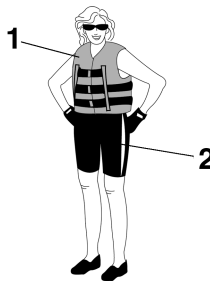

- 1 Authority-approved PFD
- 2 Wetsuit bottom

- Eye protection is recommended to keep wind, water, and glare from the sun out of your eyes while you operate your watercraft. Restraining straps for eyewear are made which are designed to float should your eyewear fall in the water. Footwear and gloves are recommended.
- You must decide whether to wear a helmet while you ride for recreation. You should know that a helmet could help protect you in

## Safety information

---

certain kinds of accidents and that it could injure you in others.

A helmet is designed to provide some head protection. Although helmets cannot protect against all foreseeable impacts, a helmet might reduce your injuries in a collision with a boat or other obstacle.

A helmet may have potential safety hazards, as well. Falling into the water could risk the chance of the helmet catching water, commonly known as “bucketing”, and the resulting strain on your neck could cause choking, severe and permanent neck injuries, or death. A helmet could also increase the risk of an accident if it reduces your vision or hearing, or if it distracts you or increases your fatigue.

How should you decide if a helmet’s potential safety benefits outweigh its potential risks for you? Consider your particular riding conditions. Consider factors such as your riding environment and your riding style and ability. Also consider the likelihood of traffic congestion, and the water surface conditions.

If you decide to wear a helmet based upon your riding circumstances, choose one carefully. Look for a helmet designed for personal watercraft use, if possible. If you will be engaging in closed-course competition, follow the helmet requirements of the sanctioning organization.

- Never operate the watercraft after consuming alcohol or taking other drugs.
- For reasons of safety and proper care of the watercraft, always perform the pre-operation checks listed on page 54 before operating the watercraft.
- The operator and passengers should always keep their feet on the floor of the footwell when the watercraft is in motion. Lifting

your feet increases the chances of losing your balance, or hitting objects outside the watercraft with your feet. Do not give a ride to children if their feet cannot reach the floor of the footwell.

- The passengers should hold on firmly, either to the person in front of them or to the handgrip provided.



- Never allow a passenger to ride in front of the operator.
- Always consult your doctor on whether it is safe for you to ride this watercraft if you are pregnant or in poor health.
- Do not attempt to modify this watercraft. Modifications to your watercraft may reduce safety and reliability, and render the watercraft unsafe or illegal for use.
- Attach the engine shut-off cord (lanyard) to your left wrist and keep it free from the handlebars so that the engine stops if you, the operator, fall off. After riding, remove the engine shut-off cord (lanyard) from the wa-

tercraft to avoid accidental starting or unauthorized use by children or others.

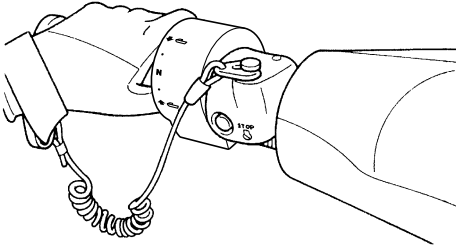

- Scan carefully for swimmers and stay away from swimming areas. Swimmers are hard to see and you could accidentally hit someone in the water.
- Avoid being hit by another boat. You should always take the responsibility to watch for traffic; other boaters may not be watching for you. If they do not see you, or if you maneuver more quickly than other boaters expect, you risk a collision.
- Maintain a safe distance from other boats and watercraft, and also watch for ski ropes or fishing lines. Obey the “Safe boating rules” and be sure to check behind you before making a turn. (See “Safe boating rules” on page 19.)

EJU30840

## Recommended equipment

The following items should be carried on board your watercraft:

- Sound-signaling device  
You should carry a whistle or other sound-signaling device that can be used to signal other boats.
- Visual distress signals  
It is recommended that a pyrotechnic device, which is approved by the appropriate authorities, be stored in a waterproof container on your watercraft. A mirror can also be used as an emergency signal. Contact a Yamaha dealer for more information.
- Watch  
A watch is helpful so you will know how long you have been operating the watercraft.
- Towline  
A towline can be used to tow a disabled watercraft in an emergency.

# Safety information

---

EJU36850

## Hazard information

- Never start the engine or let it run for any length of time in an enclosed area. Exhaust fumes contain carbon monoxide, a colorless, odorless gas that may cause loss of consciousness and death within a short time. Always operate the watercraft in an open area.
- Do not touch the hot muffler or engine during or immediately after engine operation; they can cause serious burns.

EJU30920

## Watercraft characteristics

- Jet thrust turns the watercraft. Releasing the throttle lever completely produces only minimum thrust. If you are traveling at speeds above trolling, you will have rapidly decreasing ability to steer without throttle. This model is equipped with the Yamaha Engine Management System (YEMS) that includes an off-throttle steering (OTS) system. It will activate at planing speeds should you attempt to steer the watercraft after releasing the throttle lever. The OTS system assists in turning by continuing to supply some thrust while the watercraft is decelerating, but you can turn more sharply if you apply throttle while turning the handlebars. The OTS system does not function below planing speeds or when the engine is off. Once the engine slows down, the watercraft will no longer turn in response to handlebar input until you apply throttle again or you reach trolling speed. Practice turning in an open area without obstacles until you have a good feel for this maneuver.
- This watercraft is water-jet propelled. The jet pump is directly connected to the engine. This means that jet thrust will produce some movement whenever the engine is running. There is no “neutral” position. You are in either “forward” or “reverse”, depending upon the shift lever position.
- Do not use the reverse function to slow down or stop the watercraft as it could cause you to lose control, be ejected, or impact the handlebars. This could increase the risk of back/spinal injury (paralysis), facial injuries, and broken legs, ankles, and other bones. You could also damage the shift mechanism.

## Safety information

- Reverse can be used to slow down or stop during slow-speed maneuvering, such as when docking. Once the engine is idling, shift into reverse and gradually increase engine speed. Make sure that there are no obstacles or people behind you before shifting into reverse.
- Keep away from the intake grate while the engine is on. Items such as long hair, loose clothing, or PFD straps can become entangled in moving parts, resulting in severe injury or drowning.
- Never insert any object into the jet thrust nozzle while the engine is running. Severe injury or death could result from coming in contact with the rotating parts of the jet pump.

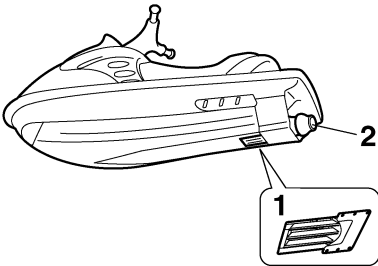

- 1 Intake grate
- 2 Jet thrust nozzle

- Stop the engine and remove the clip from the engine shut-off switch before removing

any debris or weeds, which may have collected around the jet intake.

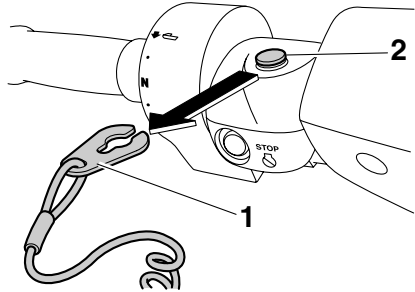

- 1 Clip
- 2 Engine shut-off switch

# Safety information

EJU30951

## Water-skiing

You can use the watercraft for water-skiing if it has the seating capacity to carry the operator, a rearward-facing spotter, and the water-skier when he or she is not skiing.

The watercraft must also have a cleat designed to pull a ski rope; do not attach the rope to any other location.

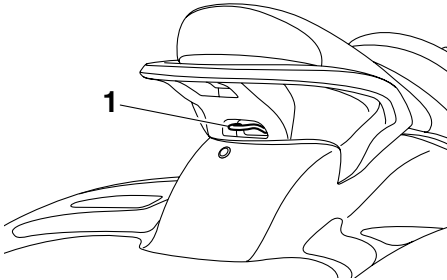

1 Cleat

It is the watercraft operator's responsibility to be alert to the safety of the water-skier and others. Know and follow all local water-skiing regulations in effect for the waters in which you will be operating.

The operator should be comfortable carrying passengers before attempting to pull a skier.

The following are some important considerations for minimizing risks while water-skiing.

- The skier should wear an approved PFD, preferably a brightly colored one so boat operators can see the skier.
- The skier should wear protective clothing. Severe internal injuries can occur if water is forced into body cavities as a result of falling into the water. Normal swimwear does not adequately protect against forceful water entry into the rectum or vagina. The skier should wear a wetsuit bottom or clothing that provides equivalent protection.
- A second person should be on board as a spotter to watch the skier; in many places it

is required by law. Let the skier direct the operator's control of speed and direction with hand signals.

The spotter should sit astride the rear of the seat and hold onto the handgrip with both feet firmly on the floor of the footwell for proper balance while facing to the rear to



watch the skier's hand signals and condition.

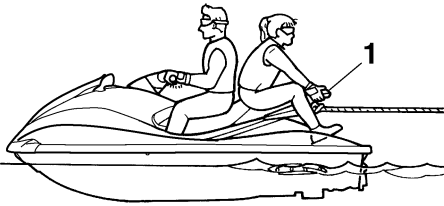

1 Handgrip

## FX SHO

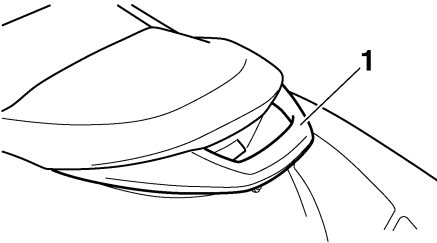

1 Handgrip

## FX Cruiser SHO

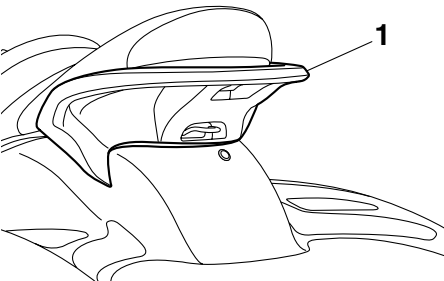

1 Handgrip

- Your control while pulling a water-skier is affected by the skier's ability, as well as water and weather conditions.
- When preparing to pull a skier, operate the watercraft at the slowest possible speed

until the watercraft is well away from the skier and slack in the ski rope is taken up. Make sure that the rope is not looped around anything.

After checking that the skier is ready and that there is no traffic or other obstacles, apply enough throttle to raise the skier.

- Make smooth, wide turns. The watercraft is capable of very sharp turns, which could exceed the abilities of the skier. Keep the skier at least 50 m (150 ft), about twice the distance of a standard ski rope, from any potential hazard.
- Be alert to the hazard of the ski rope handle snapping back at the watercraft when the skier falls or is unable to get up on the skis.
- Towing heavy or bulky objects other than skiers, such as another boat or watercraft, can cause loss of steering control and create a hazardous condition. If you must tow another boat in an emergency situation, operate slowly and cautiously.

# Safety information

---

EJU30970

## Safe boating rules

Your Yamaha watercraft is legally considered a powerboat. Operation of the watercraft must be in accordance with the rules and regulations governing the waterway on which it is used.

EJU30991

## Enjoy your watercraft responsibly

You share the areas you enjoy when riding your watercraft with others and with nature. So your enjoyment includes a responsibility to treat these other people, and the lands, waters, and wildlife with respect and courtesy. Whenever and wherever you ride, think of yourself as the guest of those around you. Remember, for example, that the sound of your watercraft may be music to you, but it could be just noise to others. And the exciting splash of your wake can make waves others won't enjoy.

Avoid riding close to shoreline homes and waterfowl nesting areas or other wildlife areas, and keep a respectful distance from fishermen, other boats, swimmers, and populated beaches. When travel in areas like these is unavoidable, ride slowly and obey all laws.

Proper maintenance is necessary to ensure that the exhaust emission and sound levels of your watercraft will continue to be within regulated limits. You have the responsibility to make sure that the recommended maintenance in this owner's/operator's manual is carried out.

Remember, pollution can be harmful to the environment. Do not refuel or add oil where a spill could cause damage to nature. Remove your watercraft from the water and move it away from the shoreline before refueling. Dispose of water and any fuel and oil residue in the engine compartment according to local regulations. And keep your surroundings pleasant for the people and wildlife that share the waterways: don't litter.

When you ride responsibly, with respect and courtesy for others, you help ensure that our

## **Safety information**

---

waterways stay open for the enjoyment of a variety of recreational opportunities.

# Features and functions

EJU31010

## Location of main components

Front view

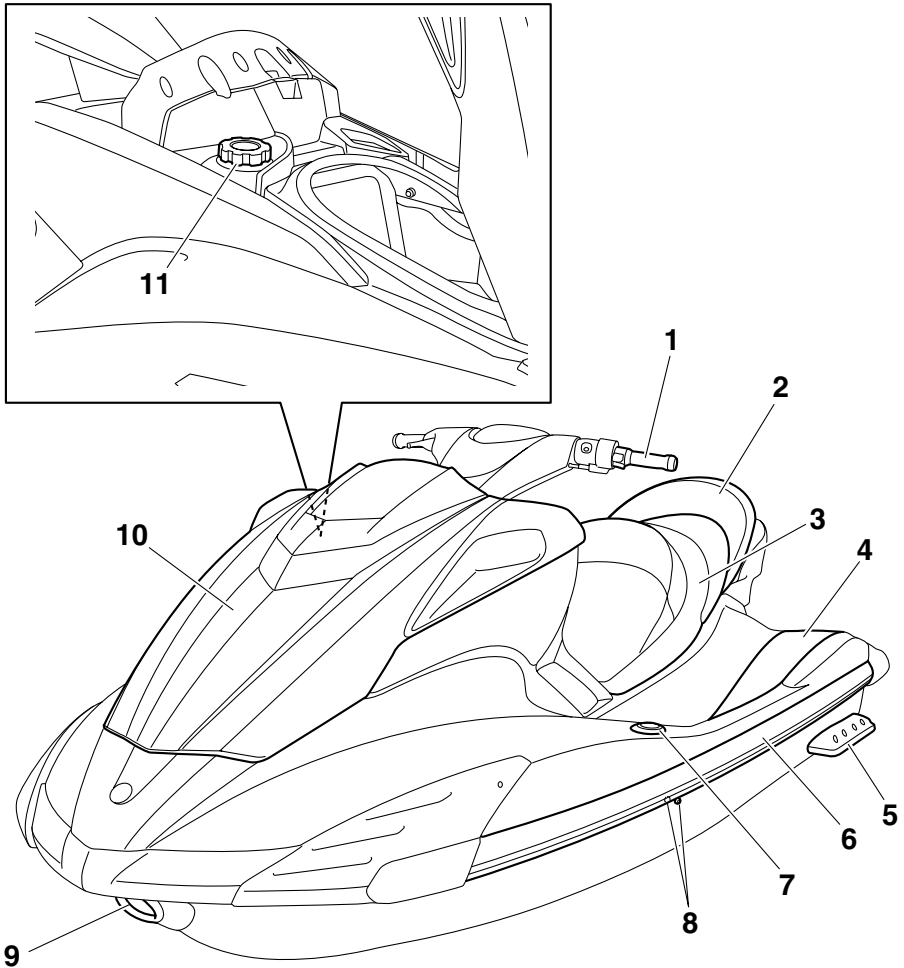

1 Handlebars

2 Rear seat

3 Front seat

4 Footwell

5 Sponsons

6 Gunwale

7 Pull-up cleat (for FX Cruiser SHO)

8 Cooling water pilot outlet

9 Bow eye

10 Hood

11 Fuel tank filler cap

# Features and functions

## Rear view

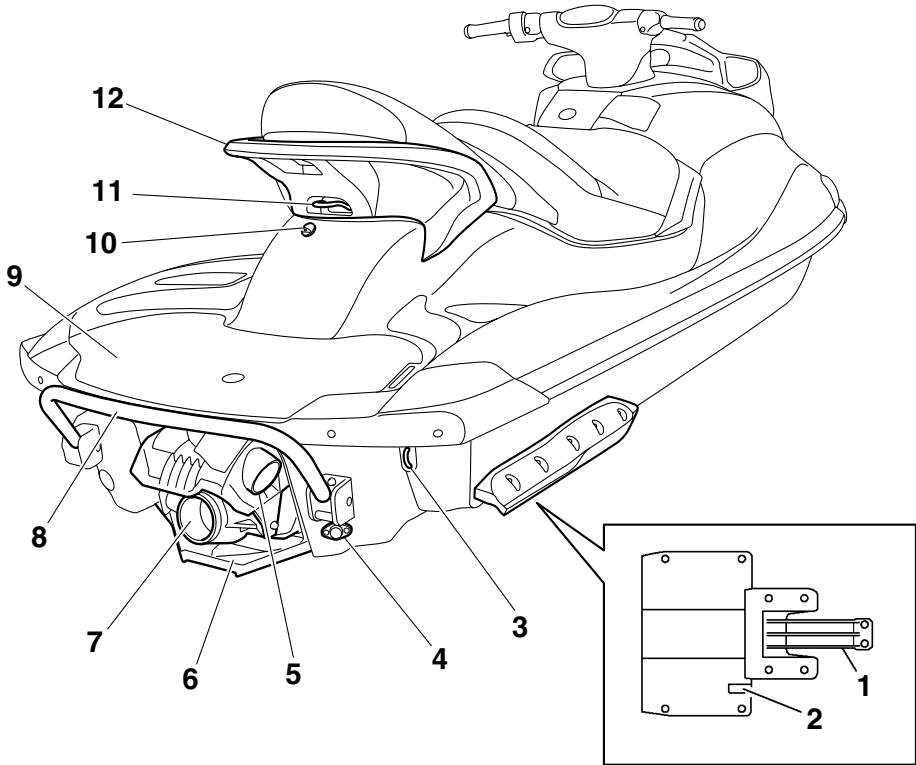

- 1 Intake grate
- 2 Speed sensor
- 3 Stern eyes
- 4 Stern drain plugs
- 5 Reverse gate
- 6 Ride plate
- 7 Jet thrust nozzle
- 8 Reboarding step
- 9 Boarding platform
- 10 Electric bilge pilot outlet
- 11 Cleat
- 12 Handgrip

# Features and functions

## Control system

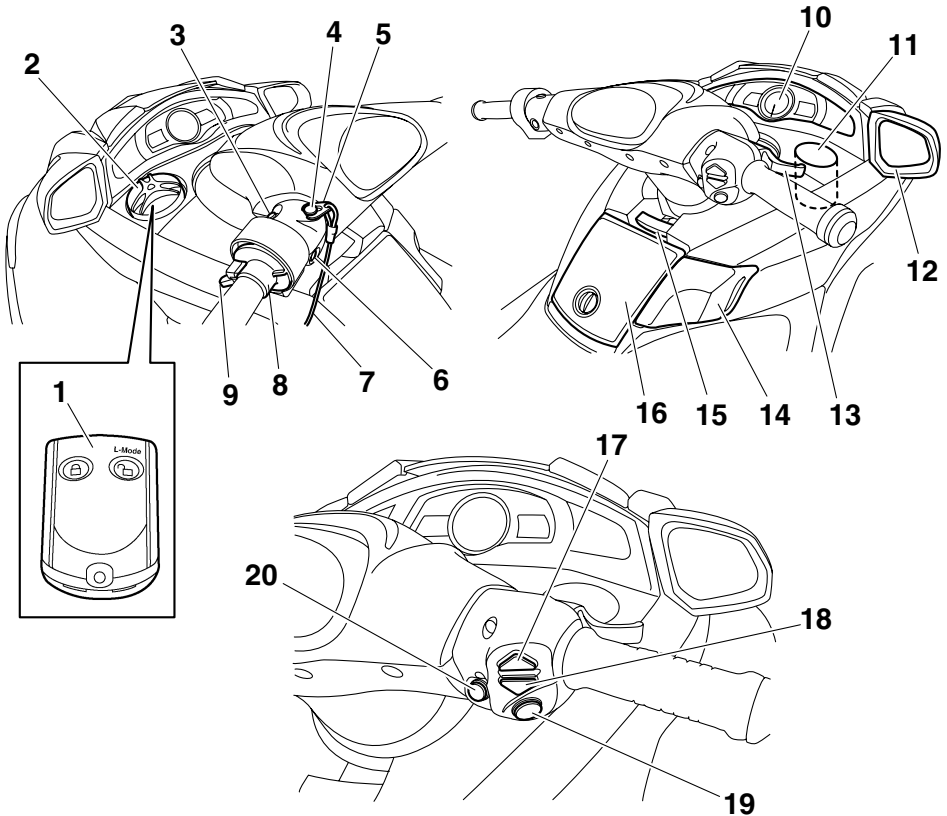

- 1 Remote control transmitter
- 2 Watertight compartment
- 3 Start switch
- 4 Engine shut-off switch
- 5 Clip
- 6 Engine stop switch
- 7 Engine shut-off cord (lanyard)
- 8 Quick Shift Trim System (QSTS) selector
- 9 QSTS selector lock lever
- 10 Multifunction information center
- 11 Beverage holder
- 12 Rearview mirrors
- 13 Throttle lever
- 14 Shift lever
- 15 Tilt lever
- 16 Glove compartment
- 17 Up switch (for cruise assist)
- 18 Down switch (for cruise assist)
- 19 "SET" switch (for cruise assist)
- 20 "NO-WAKE MODE" switch

# Features and functions

## Engine compartment

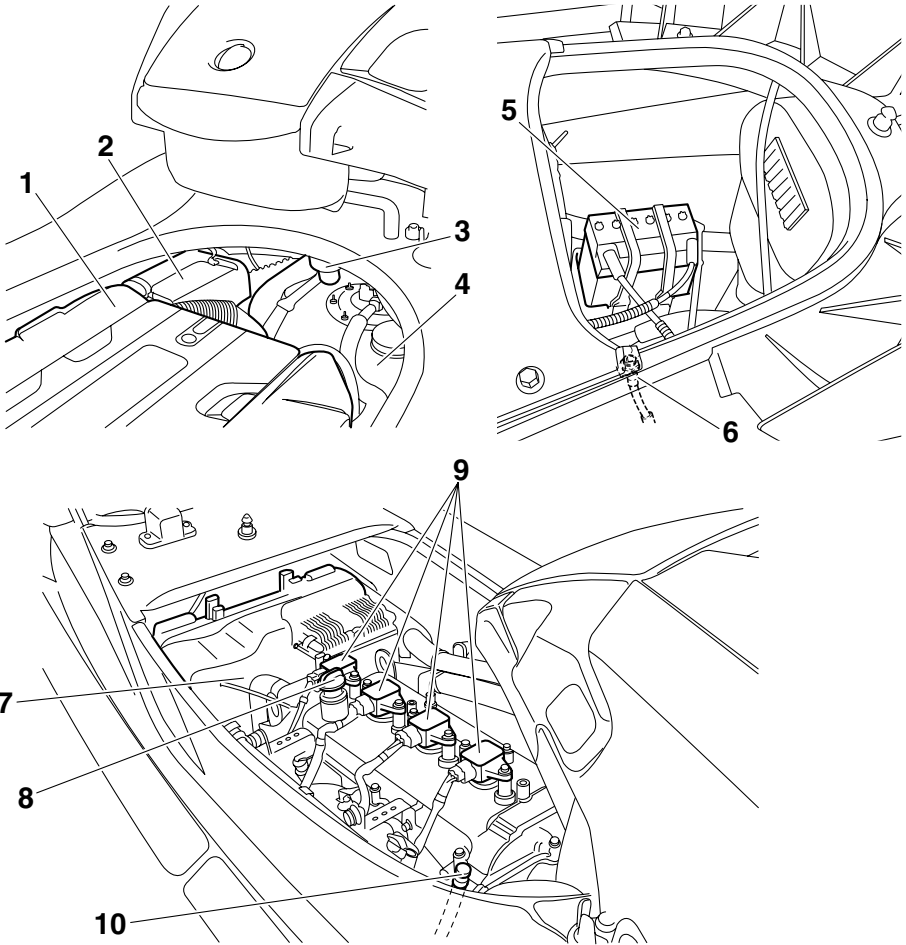

- 1 Engine cover
- 2 Air filter case
- 3 Water separator
- 4 Fuel tank
- 5 Battery
- 6 Flushing hose connector
- 7 Electrical box
- 8 Engine oil filler cap
- 9 Spark plug cap
- 10 Dipstick

# Features and functions

EJU31021

## Operation of controls and other functions

EJU31041

### Seats

To remove the rear seat:

Pull the rear seat latch up, and then pull the seat off.

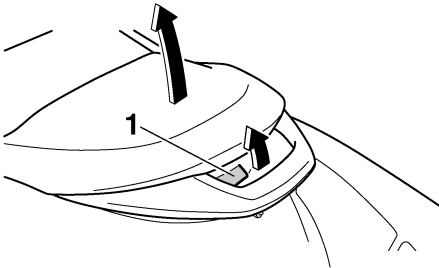

1 Seat latch

To install the rear seat:

Insert the projections on the front of the seat into the stays on the deck, and then push the rear of the seat down to lock it in place. Make

sure that the seat is securely installed before operating the watercraft.

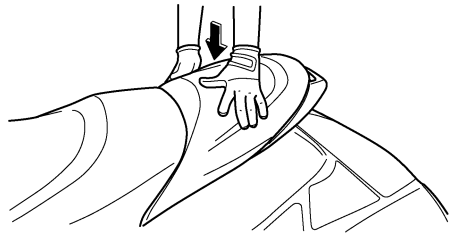
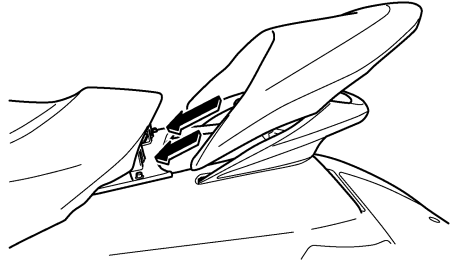

To remove the front seat:

- (1) Remove the rear seat.
- (2) Pull the front seat latch up, and then pull the seat off.

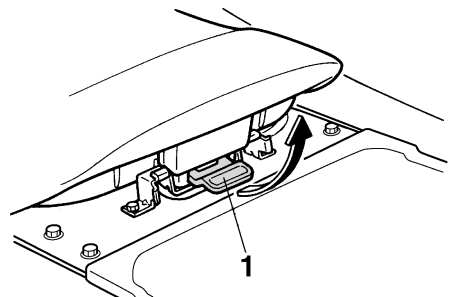

1 Seat latch

To install the front seat:

- (1) Insert the projections on the front of the seat into the stays on the deck, and then



# Features and functions

push the rear of the seat down to lock it in place.

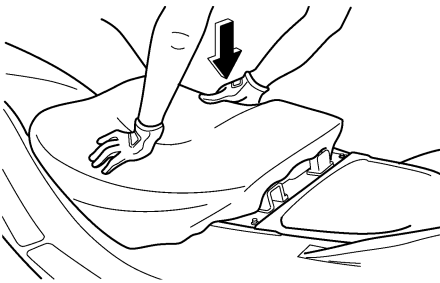
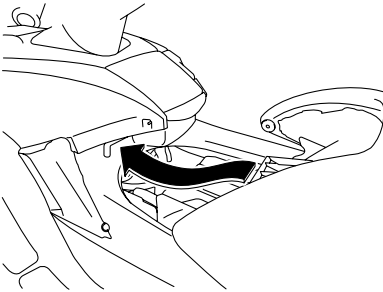

- (2) Install the rear seat. Make sure that the seats are securely installed before operating the watercraft.

EJU36682

## Hood

To open the hood, pull the visor up, and then lift up the hood.

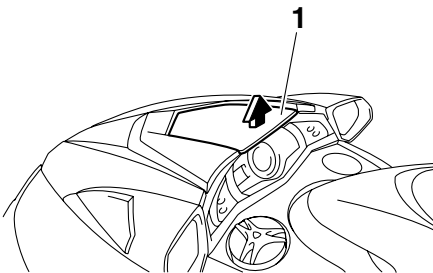

1 Visor

To close the hood, push down on the center of the hood until it latches securely. Make sure that the hood is securely closed before operating the watercraft.

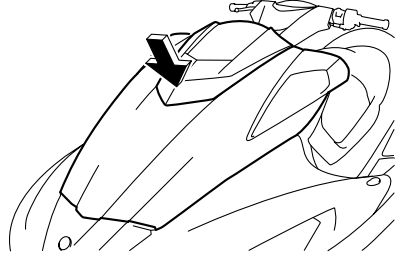

EJU36691

## Fuel tank filler cap

The fuel tank filler cap is located under the hood.

To remove the fuel tank filler cap, open the hood, and then turn the cap counterclockwise. (See page 26 for hood opening and closing procedures.)

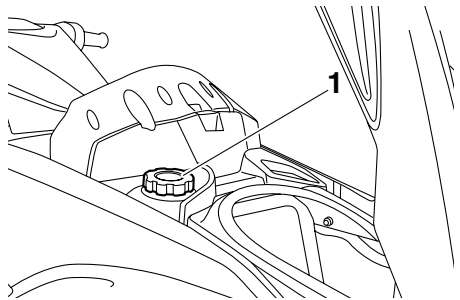

1 Fuel tank filler cap

To install the fuel tank filler cap, turn it clockwise until it stops. Make sure that the fuel tank filler cap and the hood are securely closed before operating the watercraft.

EJU37121

## Remote control transmitter

The Yamaha Security System and low-RPM mode settings are selected using the remote control transmitter. (See "Yamaha Security

# Features and functions

System” on page 34 for information on using the remote control transmitter.)



The Yamaha Security System and low-RPM mode settings can only be selected using the remote control transmitter.

Store the remote control transmitter carefully so it will not be lost. When operating the watercraft, store the transmitter in the transmitter holder provided in the watertight compartment.

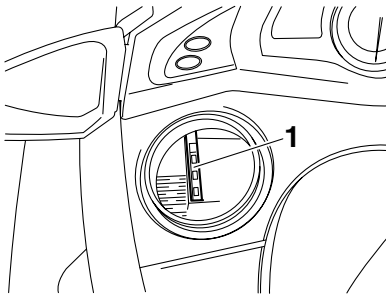

1 Transmitter holder

ECJ00751

## NOTICE

- **The remote control transmitter is not completely waterproof. Do not submerge the transmitter or operate it underwater. If the transmitter is submerged, dry it with a soft, dry cloth, and then check that it is operating properly. If the transmitter is not operating properly, contact a Yamaha dealer.**

- **Keep the remote control transmitter away from high temperatures and do not place it in direct sunlight.**
- **Do not drop the remote control transmitter, subject it to strong shocks, or place any heavy items on it.**
- **Use a soft, dry cloth to clean the remote control transmitter. Do not use detergent, alcohol, or other chemicals.**
- **Do not attempt to disassemble the remote control transmitter yourself. Otherwise, the transmitter may not operate properly. If the transmitter needs a new battery, contact a Yamaha dealer.**

## TIP:

- While the engine is running, input from the remote control transmitter is not received.
- If you accidentally lose your remote control transmitter, contact a Yamaha dealer.

EJU31150

## Engine stop switch

Push the engine stop switch (red button) to stop the engine normally.

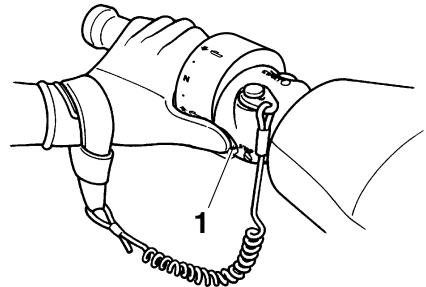

1 Engine stop switch

EJU31161

## Engine shut-off switch

Attach one end of the engine shut-off cord (lanyard) to your left wrist, and then insert the clip on the other end under the engine shut-off switch (black button). The engine will stop automatically when the clip is removed from the

# Features and functions

switch, such as if the operator falls off the watercraft. Remove the engine shut-off cord (lanyard) from the watercraft when the engine is not running to prevent unauthorized use by children or others.

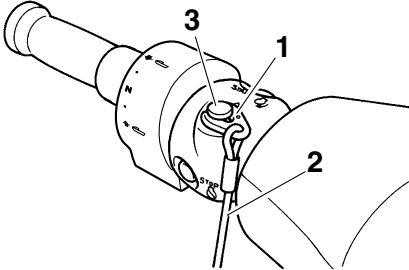

- 1 Clip
- 2 Engine shut-off cord (lanyard)
- 3 Engine shut-off switch

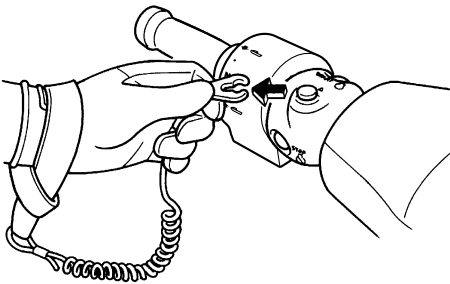

EJU36281

## Start switch

Push the start switch (green button) to start the engine.

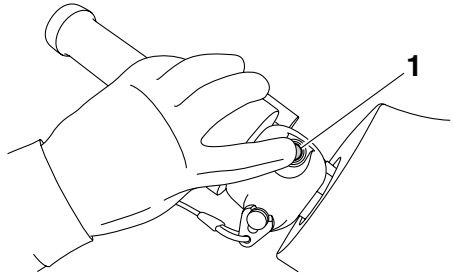

- 1 Start switch

The engine will not start under any of the following conditions:

- Lock mode of the Yamaha Security System has been selected. (See page 35 for Yamaha Security System lock and unlock mode selection procedures.)
- Clip is removed from the engine shut-off switch.
- Throttle lever is squeezed.

EJU36700

## Right handlebar switches

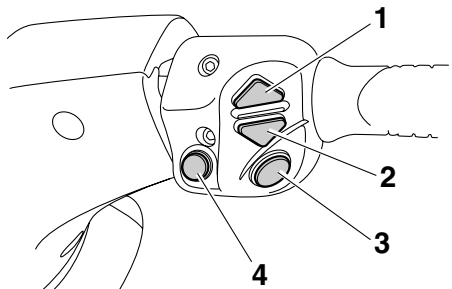

- 1 Up switch
- 2 Down switch
- 3 "SET" switch
- 4 "NO-WAKE MODE" switch

# Features and functions

EJU36710

## “SET” switch

Push this switch to activate the cruise assist. (See page 37 for more information.)

EJU36720

## Up and down switches

Push these switches to increase or decrease the engine speed while the cruise assist is operating. (See page 37 for more information.)

EJU36730

## “NO-WAKE MODE” switch

Push this switch to activate or deactivate the no-wake mode. (See page 36 for more information.)

EJU31210

## Throttle lever

Squeeze the throttle lever to increase engine speed.

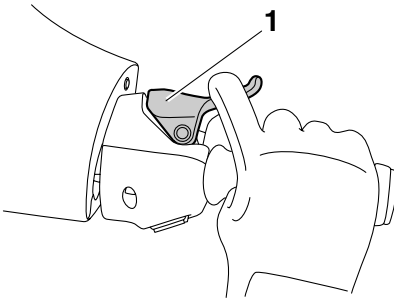

1 Throttle lever

Release the throttle lever to decrease engine speed or to return it to the idle position.

EJU36740

## Cooling water pilot outlets

This watercraft is equipped with cooling water pilot outlets on the port (left) and starboard (right) sides of the watercraft.

When the engine is running, cooling water is circulated in the engine, and then it is discharged from the pilot outlets.

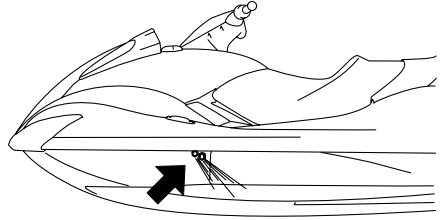

To check for proper operation of the cooling system, check that water is being discharged from the port (left) pilot outlets. If water is not being discharged from these outlets, cooling water may not be circulating in the engine. When this occurs, stop the engine and check for the cause. (See pages 45 and 95 for more information.)

## TIP:

- If the cooling water passages are dry, it will take about 60 seconds for the water to reach the outlets after the engine is started.
- Water discharge may not be constant at idle, therefore, open the throttle a little to check that water discharges properly.

# Features and functions

EJU31260

## Steering system

Your watercraft can be steered by turning the handlebars in the direction you wish to travel.

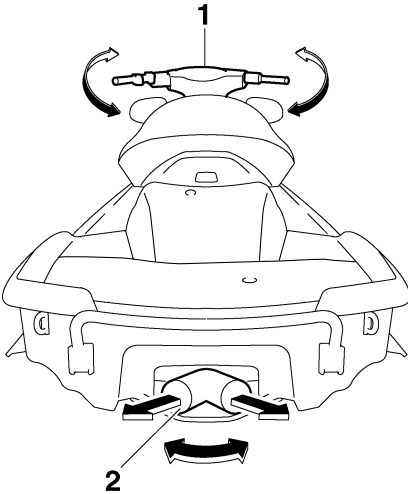

- 1 Handlebar
- 2 Jet thrust nozzle

When the handlebars are turned, the angle of the jet thrust nozzle is changed, and the direction of the watercraft is changed accordingly. Since the strength of the jet thrust determines the speed and degree of a turn, throttle must always be applied when attempting a turn, except at trolling speed.

This model is equipped with the Yamaha Engine Management System (YEMS) that includes an off-throttle steering (OTS) system. It will activate at planing speeds should you attempt to steer the watercraft after releasing the throttle lever. The OTS system assists in turning by continuing to supply some thrust while the watercraft is decelerating, but you can turn more sharply if you apply throttle while turning the handlebars.

The OTS system does not function below planing speeds or when the engine is off.

Once the engine slows down, the watercraft will no longer turn in response to handlebar input until you apply throttle again or you reach trolling speed.

EJU31291

## Tilt lever

The tilt lever is located in front of the glove compartment and is used to adjust the tilt of the handlebars. **WARNING! Never pull the tilt lever during operation, otherwise the handlebars may suddenly change position, which may lead to an accident.** [EWJ00041]

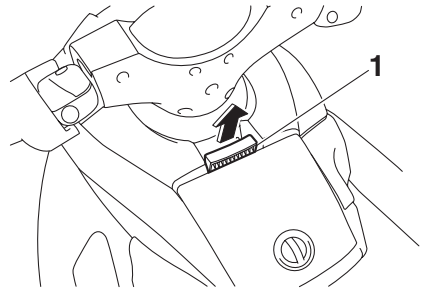

- 1 Tilt lever

To adjust the tilt, pull the tilt lever up, and then move the handlebars up or down to the desired position.

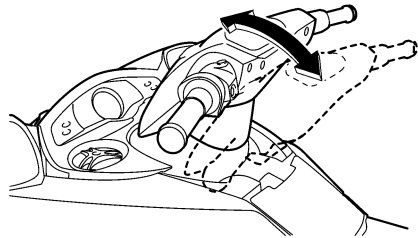

Make sure that the tilt lever returns to its original position and that the handlebars are locked in place after adjusting them.

# Features and functions

EJU31301

## Shift lever

The shift lever is located on the starboard (right) side of the watercraft and is used to control the reverse gate, which allows the watercraft to move in reverse or forward.

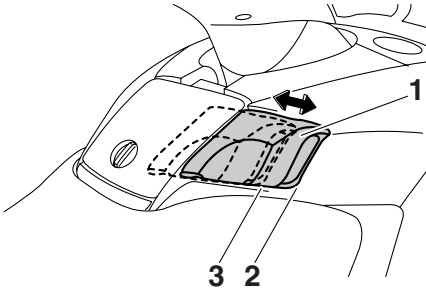

- 1 Shift lever
- 2 Forward position
- 3 Reverse position

When the shift lever is in the reverse position, the watercraft can be launched from a trailer, or backed up out of tight spots where you cannot turn around easily.

EJU31312

## Quick Shift Trim System (QSTS) selector

The QSTS selector is located at the left handlebar grip and is used to adjust the trim angle of the watercraft.

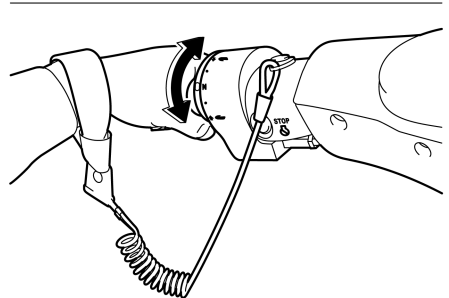
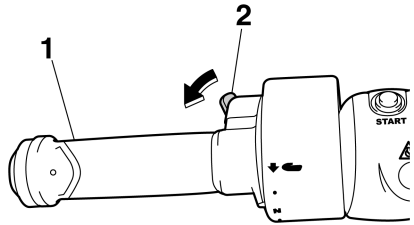

- 1 Quick Shift Trim System (QSTS) selector
- 2 QSTS selector lock lever

Operating the QSTS selector changes the angle of the jet thrust nozzle vertically. This changes the trim angle of the watercraft.

# Features and functions

There are 5 positions: 2 bow-down positions (a) and (b), neutral “N”, and 2 bow-up positions (c) and (d).

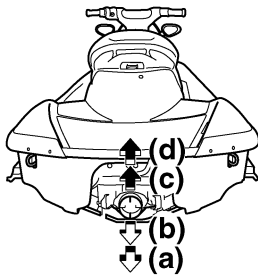
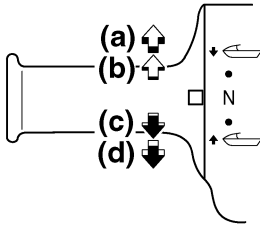

## To change the trim angle:

- (1) Reduce engine speed to less than 3000 r/min.
- (2) Squeeze the QSTS selector lock lever, and then turn the QSTS selector to the desired position. **NOTICE: Do not turn the QSTS selector while operating the watercraft at an engine speed of 3000 r/min or more, otherwise damage could occur to the QSTS.** [ECJ00012]
- (3) Release the lock lever to lock the QSTS selector.

The neutral “N” position will provide good performance for most operating conditions.

To enhance particular types of performance, select bow down or bow up.

(d) ↑

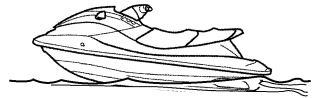

(c) ↑

N

(b) ↓

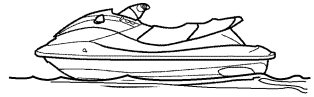

(a) ↓



EJU31330

## **Bow down**

Turn the QSTS selector to (a) or (b) and the bow will go down while the watercraft is on plane.

Bow down puts more of the bow in the water. This gives the watercraft more “hook”, which enhances turning performance. This position will also help the watercraft get up on plane more quickly.

At higher speeds, however, the watercraft will have a greater tendency to “bow steer” and follow waves and wakes in the water. Fuel economy and maximum speed are also reduced.

EJU31340

## **Bow up**

Turn the QSTS selector to (c) or (d) and the bow will go up while the watercraft is on plane. Bow up puts less of the bow in the water. There is less water resistance, so straight-

# Features and functions

ahead acceleration when on plane and top speed are enhanced.

In some conditions, however, the watercraft may tend to “porpoise” (hop in the water). If the watercraft is porpoising, select neutral or bow down.

EJU31361

## Handgrip

The handgrip provides a handhold for boarding the watercraft and for a spotter when facing rearward. **WARNING! Do not use the handgrip to lift the watercraft. The handgrip is not designed to support the watercraft’s weight. If the handgrip breaks, the watercraft could fall, which could result in severe injury.** [EWJ00021]

## FX SHO

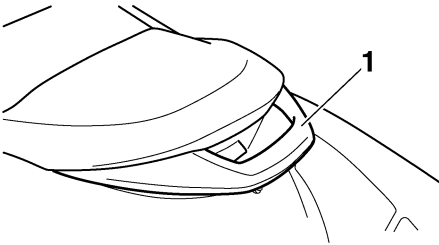

1 Handgrip

## FX Cruiser SHO

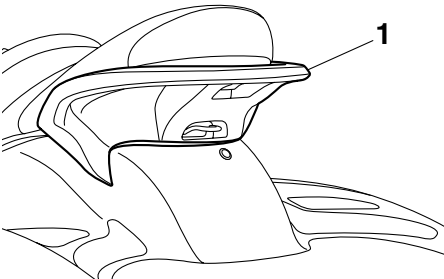

1 Handgrip

EJU34862

## Reboarding step

The reboarding step provides a handhold and footstep for boarding the watercraft.

**WARNING! Do not use the reboarding step to lift the watercraft. The reboarding step is not designed to support the watercraft’s weight. If the reboarding step breaks, the watercraft could fall, which could result in severe injury.** [EWJ01211]

ECJ00742

## NOTICE

Use the reboarding step only to board the watercraft in the water. Do not use the reboarding step for any other purpose. The watercraft can be damaged.

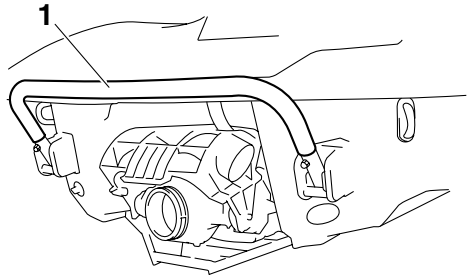

1 Reboarding step

EJU34870

## Bow eye

The bow eye is located at the bow of the watercraft.



# Features and functions

The bow eye is used to attach a rope to the watercraft when transporting, mooring, or towing it in an emergency.

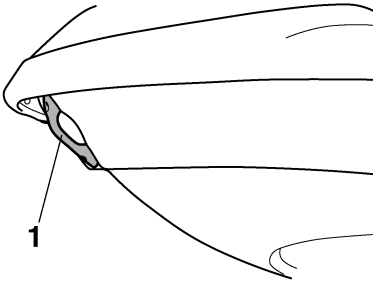

1 Bow eye

EJU34880

## Stern eyes

The stern eyes are located at the stern of the watercraft.

The stern eyes are used to attach a rope to the watercraft when transporting or mooring it.

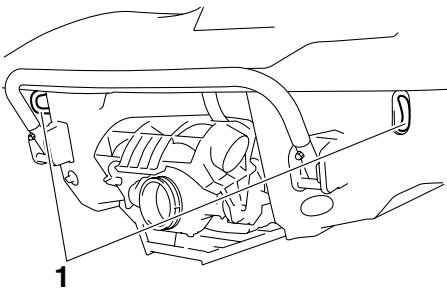

1 Stern eye

EJU34891

## Pull-up cleats (for FX Cruiser SHO)

The pull-up cleats are used to attach a rope to the watercraft when mooring it.

To use a pull-up cleat, pull it up. **WARNING! Do not use the pull-up cleats to lift the watercraft. The pull-up cleats are not designed to support the watercraft's weight. If the pull-up cleats break, the watercraft**

**could fall, which could result in severe injury.** [EWJ00821]

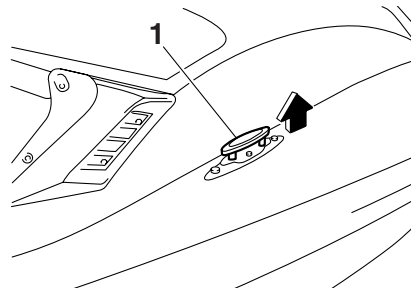

1 Pull-up cleat

EJU31370

## Yamaha Engine Management System (YEMS)

This model is equipped with an integrated, computerized management system that controls and adjusts ignition timing, fuel injection, engine diagnostics, and the off-throttle steering (OTS) system.

EJU31381

## Yamaha Security System

The Yamaha Security System functions to help prevent unauthorized use or theft of the watercraft. The engine cannot be started if the security system is in the lock mode. The engine can only be started in the unlock mode. The lock and unlock modes of the security system are selected using the remote control transmitter that is included with this watercraft.

## TIP:

Since the watercraft is programmed to recognize the internal code from this transmitter only, the security system setting can only be changed with this transmitter. If you lose the remote control transmitter or if it does not operate properly, contact a Yamaha dealer.

# Features and functions

(See page 26 for information on using the remote control transmitter.)

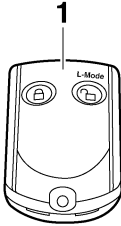

1 Remote control transmitter

EJU36771

## Yamaha Security System settings

The Yamaha Security System settings are selected by pressing the lock or unlock button on the remote control transmitter briefly.

Depending on the selected Yamaha Security System setting, the “UNLOCK” indicator light will come on or go off.

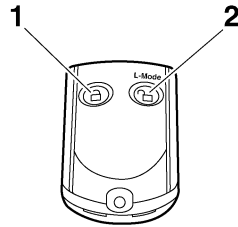

- 1 Lock button
- 2 Unlock button

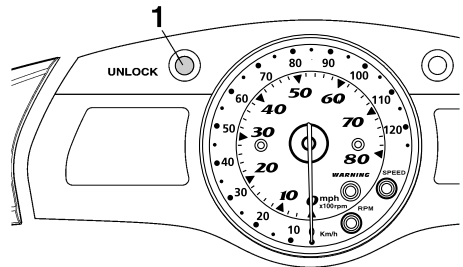

- 1 “UNLOCK” indicator light

### TIP:

The lock and unlock modes of this system can only be selected while the engine is stopped.

### LOCK

When the lock button on the remote control transmitter is pressed briefly, the beeper sounds once and the “UNLOCK” indicator light goes off. This indicates the lock mode is selected and the engine cannot be started.

### UNLOCK

When the unlock button on the remote control transmitter is pressed briefly, the beeper sounds two or three times and the “UNLOCK” indicator light comes on. This indicates the

# Features and functions

unlock mode is selected and the engine can be started.

## TIP:

The beeper sounds two times for the normal mode or three times for the low-RPM mode. (See the items in “Selecting the operation mode” for operation mode information.)

Number of beeps	Yamaha Security System mode	Engine can be started
●	Lock	NO
● ●	Unlock (normal mode)	YES
● ● ●	Unlock (low-RPM mode)	YES

If neither the start switch nor the remote control transmitter is operated within 25 seconds after the unlock button is pressed to select the unlock mode, the multifunction information center will turn off and enter a standby state. If the multifunction information center is in the standby state, start the engine to return the display and the indicator lights to their state before the center turned off.

EJU36781

## Selecting the operation mode

There are two operation modes in the unlock mode of the Yamaha Security System: the normal mode and the low-RPM mode. The normal mode and low-RPM mode can only be selected when the engine is stopped in the unlock mode. Press the unlock button on the remote control transmitter for more than 4 seconds to switch between the normal mode and the low-RPM mode.

### Normal mode

The watercraft can be ridden normally in this mode.

If the beeper sounds two times, the normal mode is activated.

### Low-RPM mode

Maximum engine speed (r/min) in this mode is limited to approximately 70% of the maximum engine speed in the normal mode.

If the beeper sounds three times, the low-RPM mode is activated and the “L-MODE” indicator light comes on.

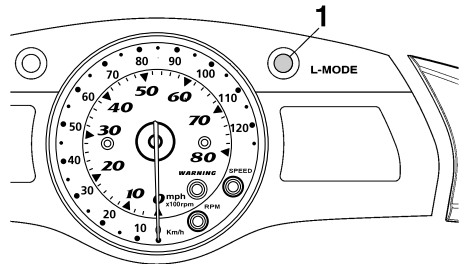

1 “L-MODE” indicator light

EJU37011

### No-wake mode

The no-wake mode is a function that maintains the engine speed at a fixed setting for operating the watercraft at low speeds. This function can be used only for forward operation of the watercraft.

### Activating and deactivating the no-wake mode

Activation of the no-wake mode will be confirmed by the beeper and the digital speedometer display.

Number of beeps	No-wake mode operation	Digital speedometer display
● ● ●	Activated	Starts flashing
● ●	Deactivated	Stops flashing

## TIP:

The beeps and the flashing digital speedometer display also indicate the activation of the cruise assist. (See page 37 for more information.)

# Features and functions

To activate the no-wake mode:

## TIP:

The no-wake mode cannot be activated immediately after starting the engine. After starting the engine, wait for 5 seconds or more before activating the mode.

- (1) Release the throttle lever.
- (2) Check that the shift lever is in the forward position.

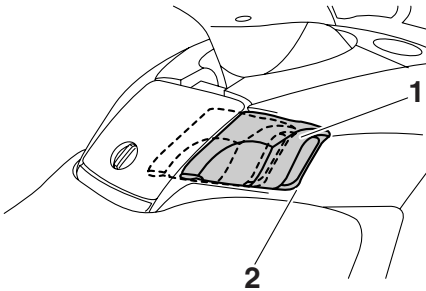

- 1 Shift lever
- 2 Forward position

## TIP:

The no-wake mode cannot be activated when the shift lever is in the reverse position.

- (3) Push and hold the “NO-WAKE MODE” switch. When the no-wake mode is activated, the beeper sounds three times quickly and “5” (when miles are selected) or “8” (when kilometers are selected) starts flashing in the digital speedometer display. Keep the throttle lever in the idle position when the no-wake mode is activated.

## TIP:

The digital speedometer display flashes continually while the no-wake mode is activated.

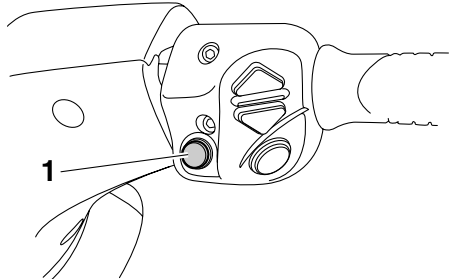

1 “NO-WAKE MODE” switch

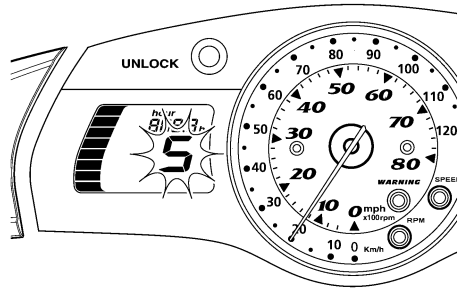

To deactivate the no-wake mode:

Perform one of the following procedures. The beeper sounds two times quickly and the digital speedometer display stops flashing when the no-wake mode is deactivated.

- Push the “NO-WAKE MODE” switch.
- Squeeze the throttle lever.

## TIP:

The no-wake mode is also deactivated when the engine is stopped.

EJU37022

## Cruise assist

The cruise assist is a function for maintaining a desired engine speed within a fixed range while operating the watercraft.

# Features and functions

## Activating and deactivating the cruise assist

Activation of the cruise assist will be confirmed by the beeper and the digital speedometer display.

Number of beeps	Cruise assist operation	Digital speedometer display
● ● ●	Activated	Starts flashing
● ●	Deactivated	Stops flashing
●	Engine speed increases or decreases	Continues flashing

### TIP:

The beeps and the flashing digital speedometer display also indicate the activation of the no-wake mode. (See page 36 for more information.)

To activate the cruise assist:

### TIP:

- The cruise assist can only be set between engine speeds of approximately 3000 r/min and approximately 7000 r/min.
  - The cruise assist cannot be activated in the low-RPM mode. (See the items in 36 for operation mode information.)
- (1) Operate the throttle lever until the desired engine speed is reached.
  - (2) Once the engine speed reaches the desired cruise assist setting, push the “SET” switch. When the cruise assist is activated, the beeper sounds three times quickly and the digital speedometer display starts flashing. To keep the cruise assist activated, be sure to keep the throttle lever squeezed further than the position at which the cruise assist was set; releasing the throttle lever will deactivate the cruise assist.

### TIP:

The digital speedometer display flashes continually while the cruise assist is activated. Make sure that the beeper has sounded and the digital speedometer display is flashing before squeezing the throttle lever to the full throttle position. If the speedometer display is not flashing, the cruise assist is not activated

# Features and functions

and the engine will respond normally to the throttle.

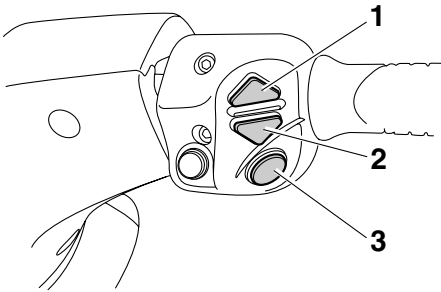

- 1 Up switch
- 2 Down switch
- 3 "SET" switch

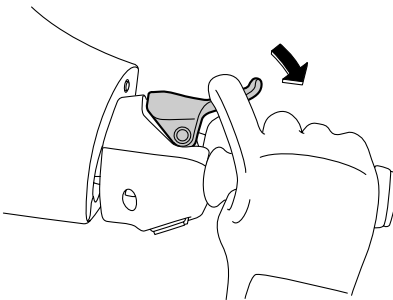
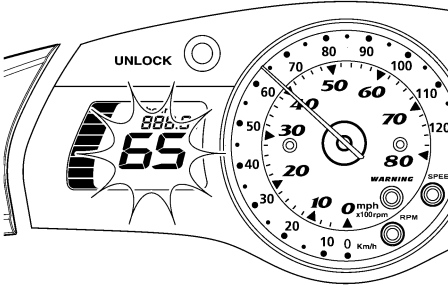

## TIP:

Once the cruise assist is activated, the engine speed can be increased by pushing the up switch or decreased by pushing the down switch. Each time a switch is pushed, the beeper will sound one time quickly and the

engine speed will change. However, the adjustment is limited to a maximum of five increments above or below the initial cruise assist setting.

## To deactivate the cruise assist:

Relax your grip on the throttle lever. The beeper sounds two times quickly and the digital speedometer display stops flashing when the cruise assist is deactivated.

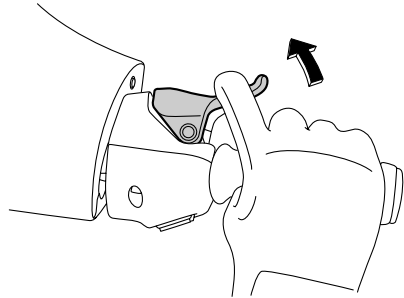

## TIP:

The cruise assist is also deactivated when the engine is stopped.

EJU34903

## Multifunction information center

The multifunction information center is equipped with the following three main com-

# Features and functions

ponents for help and convenience in operating the watercraft.

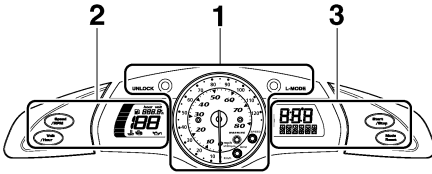

- 1 Analog speedometer/tachometer and indicator lights
- 2 Left multifunction display and operation buttons
- 3 Right multifunction display and operation buttons (for FX Cruiser SHO)

When the multifunction information center starts operating, the analog speedometer/tachometer makes one sweep, all displays light up for 2 seconds, and then the meter starts to operate normally.

The multifunction information center will continue to operate for 25 seconds after the engine stops.

EJU34930

## Analog speedometer/tachometer and indicator lights

This watercraft is equipped with the following meter and indicator lights.

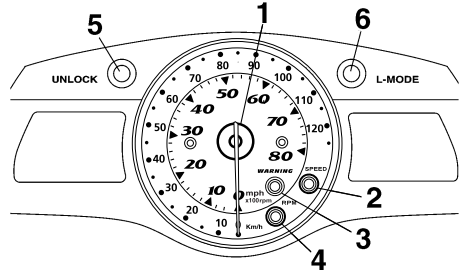

- 1 Analog speedometer/tachometer
- 2 "SPEED" indicator light
- 3 "WARNING" indicator light
- 4 "RPM" indicator light
- 5 "UNLOCK" indicator light
- 6 "L-MODE" indicator light

EJU36791

## Analog speedometer/tachometer

The analog speedometer/tachometer can be used as a speedometer or a tachometer.

To switch between the speedometer and the tachometer functions, push the "Speed/RPM" button for at least 1 second when the multifunction information center is operating.

The "SPEED" indicator light comes on when the analog speedometer is selected. The

# Features and functions

“RPM” indicator light comes on when the analog tachometer is selected.

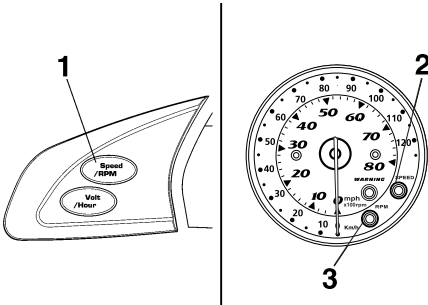

- 1 “Speed/RPM” button
- 2 “SPEED” indicator light
- 3 “RPM” indicator light

The “SPEED” indicator light blinks three times, then comes on, if miles are selected as the display units when the analog speedometer/tachometer is switched to the speedometer function.

## Analog speedometer

The analog speedometer shows the watercraft speed against water.

The large inner numbers on the meter show the watercraft speed in miles per hour (mph) and the small outer numbers show the speed in kilometers per hour (km/h) when the speedometer function is selected.

## Analog tachometer

The analog tachometer shows the engine speed.

The large inner numbers on the meter show the engine speed ( $\times 100$  r/min) when the tachometer function is selected.

EJU36800

## “SPEED” indicator light

The “SPEED” indicator light comes on when the analog speedometer is selected.

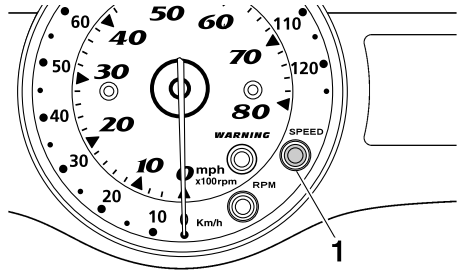

- 1 “SPEED” indicator light

The “SPEED” indicator light blinks three times in the following instances:

- The analog speedometer/tachometer is switched to the speedometer function when miles are selected as the display units.
- The display units of the multifunction information center are switched to miles from kilometers.
- Miles are selected as the display units when the multifunction information center starts operating.

EJU34960

## “RPM” indicator light

The “RPM” indicator light comes on when the analog tachometer is selected.

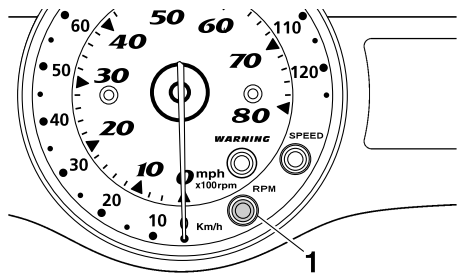

- 1 “RPM” indicator light



# Features and functions

EJU34980

## “WARNING” indicator light

The “WARNING” indicator light blinks or comes on, together with a warning indicator, when a malfunction has occurred.

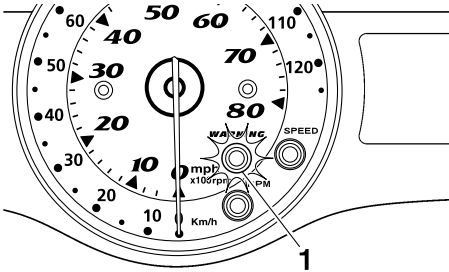

1 “WARNING” indicator light

EJU34990

## “UNLOCK” indicator light

The “UNLOCK” indicator light comes on when the unlock mode of the Yamaha Security System is selected. The watercraft can be ridden normally when this light is on. (See page 35 for more information.)

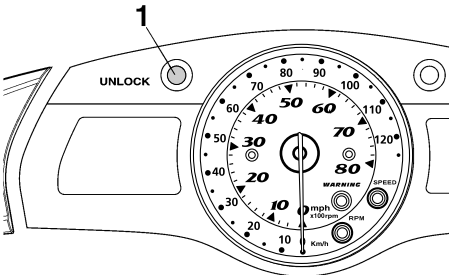

1 “UNLOCK” indicator light

EJU35010

## “L-MODE” indicator light

The “L-MODE” indicator light comes on when the low-RPM mode is selected. (See page 36 for more information.)

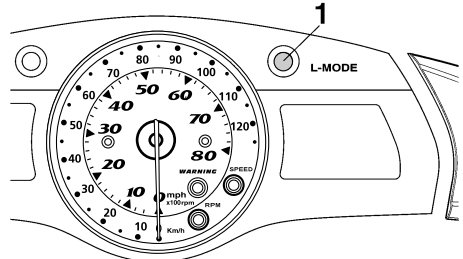

1 “L-MODE” indicator light

EJU35021

## Left multifunction display and operation buttons

The left multifunction display is equipped with the following functions.

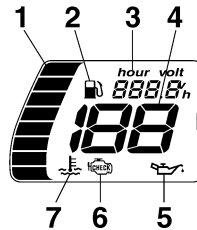

- 1 Fuel level meter
- 2 Fuel level warning indicator
- 3 Hour meter/voltmeter
- 4 Digital speedometer
- 5 Oil pressure warning indicator
- 6 Check engine warning indicator
- 7 Engine overheat warning indicator

# Features and functions

The following operation buttons are on the left side of the multifunction information center.

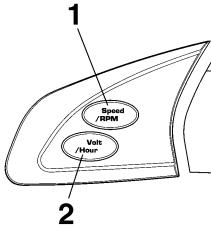

- 1 "Speed/RPM" button
- 2 "Volt/Hour" button

EJU37081

## Digital speedometer

The digital speedometer shows the watercraft speed against water.

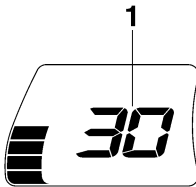

- 1 Digital speedometer

To switch the speedometer display between kilometers and miles, push the "Volt/Hour" button for at least 1 second, within 10 seconds after the multifunction information center starts operating.

The "SPEED" indicator light blinks three times if miles are selected as the display units when the multifunction information center starts operating, or if the display units are switched to miles.

## TIP:

Kilometers are selected as the display units at the Yamaha factory.

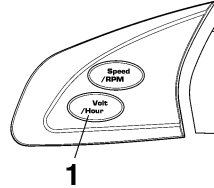

- 1 "Volt/Hour" button

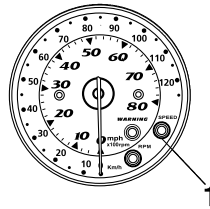

- 1 "SPEED" indicator light

EJU31512

## Fuel level meter

The fuel level meter is provided for convenient fuel level checking while riding.

The fuel level meter has eight segments which show the amount of fuel remaining in the fuel tank. The display segments of the fuel

# Features and functions

level meter disappear two at a time as the fuel level decreases.

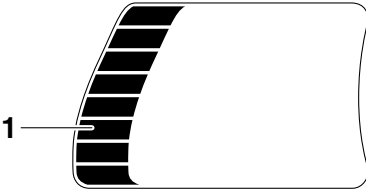

1 Fuel level meter

## TIP:

The fuel level is most accurate when the watercraft is sitting level on a trailer or in the water.

EJU35061

## Hour meter/voltmeter

To switch the display between the hour meter and the voltmeter, push the “Volt/Hour” button for at least 1 second after the meter is displayed for more than 10 seconds.

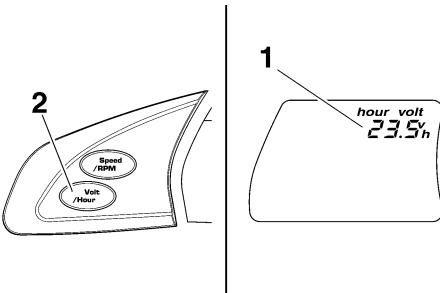

1 Hour meter/voltmeter

2 “Volt/Hour” button

## Hour meter

The hour meter is provided to make it easy to follow the maintenance schedule.

The meter shows the hours of engine operation that have elapsed since the watercraft was new.

## Voltmeter

The voltmeter is provided to display the voltage of the battery.

When the battery voltage is normal, the voltmeter displays approximately 12 volts.

If the battery voltage is less than 8.0 volts, “LO” is displayed on the voltmeter and if the voltage is above 18.1 volts, “HI” is displayed on the voltmeter. If “HI” or “LO” is displayed, return to shore and, if necessary, have a Yamaha dealer check the charging system and the battery.

EJU36811

## Fuel level warning indicator

If the fuel remaining in the fuel tank drops to about 18 L (4.8 US gal, 4.0 Imp. gal), the lowest two fuel level segments, the fuel level warning indicator, and the “WARNING” indicator light begin to blink. The buzzer also starts sounding intermittently.

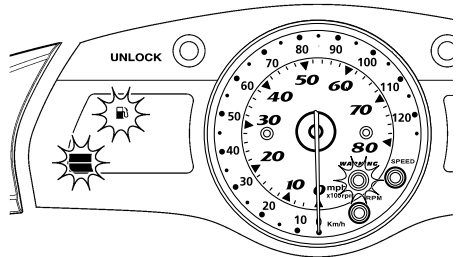

If this occurs, refill the fuel tank as soon as possible.

The warning signals will be cleared when the engine is restarted after the fuel tank is refilled.

## TIP:

Press any button on the multifunction information center to stop the buzzer.

EJU35122

## Oil pressure warning indicator

If the oil pressure does not rise to specification, the “WARNING” indicator light and the oil

# Features and functions

pressure warning indicator begin to blink, and the buzzer sounds intermittently. At the same time, the engine speed is limited to help prevent damage.

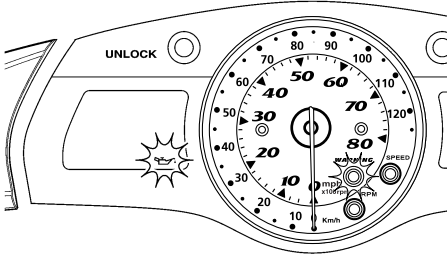

If this occurs, reduce the engine speed, return to shore, and then check the engine oil level. (See page 56 for engine oil level checking procedures.) If the oil level is low, add enough engine oil to raise it to the proper level. If the oil level is sufficient, have a Yamaha dealer check the watercraft.

## TIP:

Press any button on the multifunction information center to stop the buzzer.

EJU36821

## Engine overheat warning indicator

This model is equipped with an engine overheat warning system.

If the engine starts to overheat, the “WARNING” indicator light and the engine overheat warning indicator blink, and then come on. The buzzer also begins to sound intermittently, and then it sounds continuously. After the light and indicator start to blink and the buzzer

sounds, the engine speed is limited to help prevent damage.

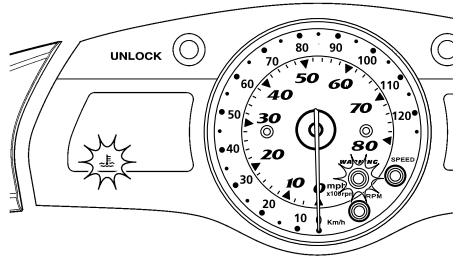

If this occurs, immediately reduce the engine speed, return to shore, and then check for water discharge at the port (left) cooling water pilot outlets while the engine is running. If there is no discharge of water, shut the engine off, and then check the intake grate and impeller for clogging. (See page 95 for more information.) **NOTICE: If you cannot locate and correct the cause of the overheating, consult a Yamaha dealer. Continuing to operate at higher speeds could result in severe engine damage.** [ECJ00041]

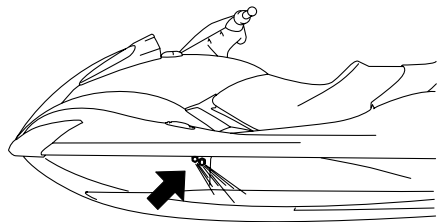

## TIP:

Press any button on the multifunction information center to stop the buzzer.

EJU35131

## Check engine warning indicator

If a sensor malfunction or a short circuit is detected, the “WARNING” indicator light and the

# Features and functions

check engine warning indicator begin to blink, and the buzzer sounds intermittently.

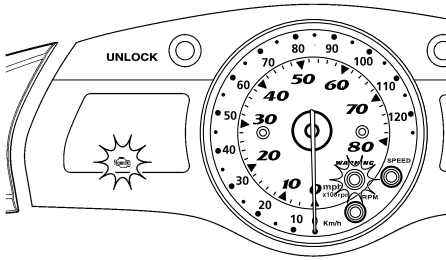

If this occurs, reduce the engine speed, return to shore, and have a Yamaha dealer check the engine.

## TIP:

Press any button on the multifunction information center to stop the buzzer.

EJU35034

## Right multifunction display and operation buttons (for FX Cruiser SHO)

The right multifunction display shows the following information.

- Compass
- Average speed
- Tripmeter
- Trip timer
- Fuel consumption per hour
- Fuel consumption per kilometer/mile
- Water temperature
- Air temperature

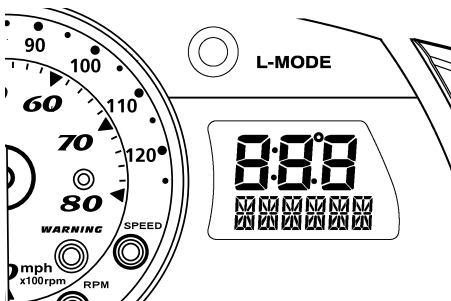

The following operation buttons are on the right side of the multifunction information center.

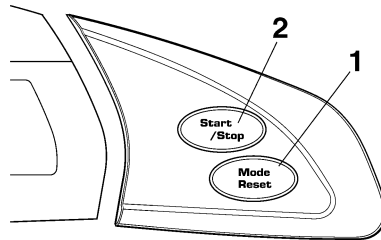

- 1 "Mode/Reset" button
- 2 "Start/Stop" button

To switch the display mode, push the "Mode/Reset" button for less than 1 second. The display mode changes in the following order.

Compass → Average speed → Tripmeter → Trip timer → Fuel consumption per hour → Fuel consumption per kilometer/mile → Water temperature → Air temperature

To switch the display units between kilometers/liters/degrees Celsius and miles/gallons/degrees Fahrenheit, push the "Volt/Hour" button for at least 1 second, within 10 seconds after the multifunction information center starts operating.

The "SPEED" indicator light blinks three times if miles/gallons/degrees Fahrenheit are selected as the display units when the multifunction information center starts operating, or if

# Features and functions

the display units are switched to miles/gallons/degrees Fahrenheit.

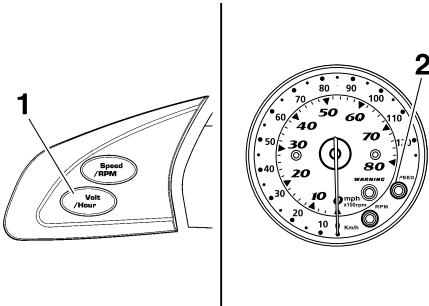

- 1 "Volt/Hour" button
- 2 "SPEED" indicator light

## Compass

This display shows the current direction of the watercraft using the 8 major compass points.

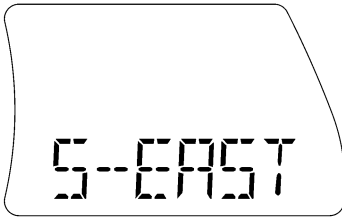

### TIP:

The accuracy of the compass varies depending on the operating conditions. Use this function as a reference only.

## Average speed

This display shows the average speed in miles per hour "AV MPH" or kilometers per hour "AV KMH" since it was reset.



## Tripmeter

This display shows the distance traveled in miles "MILES" or kilometers "KM" since it was reset.

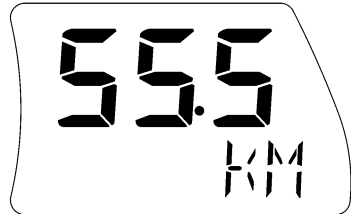

## Trip timer

This display shows the hours of operation "TRIP TM" since it was reset.



# Features and functions

## Fuel consumption per hour

This display shows the current fuel consumption in gallons per hour “G/HR” or liters per hour “L/HR”.

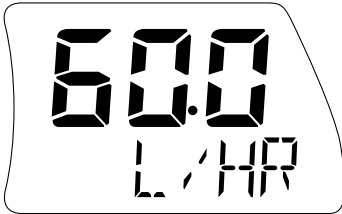

## Water temperature

This display shows the ambient water temperature “L TEMP” (lake temperature).

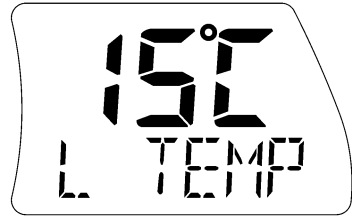

## Fuel consumption per kilometer/mile

This display shows the current fuel consumption in gallons per mile “G/MILE” or liters per kilometer “L/KM”.

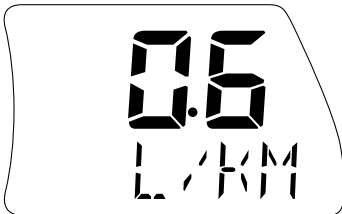

## Air temperature

This display shows the ambient air temperature “E TEMP” (environmental temperature).

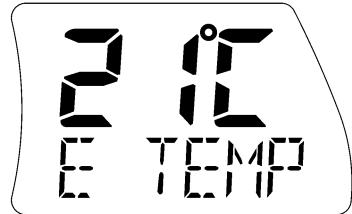

## TIP:

The actual fuel consumption varies depending on the operating conditions. Use this function as a reference only.

## Average speed/Tripmeter/Trip timer modes

Average speed, distance traveled, and trip time are recorded once measurements have started, regardless of the current display.

To start the measurements, push the “Start/Stop” button for less than 1 second. The beeper sounds once.

To stop the measurements, push the “Start/Stop” button for less than 1 second. The beeper sounds once. To restart the measurements, push the “Start/Stop” button for less than 1 second. The beeper sounds once.

To reset the displays, push the “Mode/Reset” button for at least 2 seconds while the mea-

# Features and functions

measurements are stopped. The beeper sounds twice.

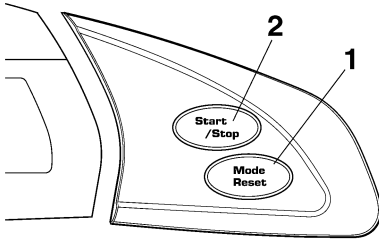

- 1 "Mode/Reset" button
- 2 "Start/Stop" button

The displays can be reset only when the measurements are stopped.

The measurements are not saved if the engine is stopped. The displays are reset automatically when they go off 25 seconds after the engine stops.

EJU35142

## Storage compartments

A front storage compartment, glove compartment, seat storage compartment, watertight compartment, and beverage holder are provided.

Only the securely closed watertight compartment is waterproof. If you carry objects that must be kept dry, such as the manuals, put them in a waterproof bag or in the watertight compartment.

Make sure that the storage compartments are closed securely before operating the watercraft.

EJU36832

## Front storage compartment

The front storage compartment is located at the bow.

To open the front storage compartment, pull the visor up, and then lift the hood.

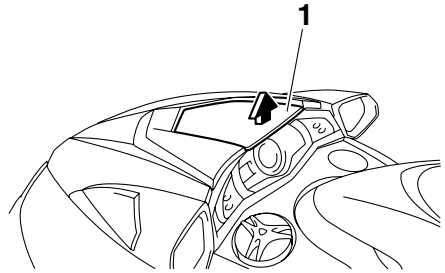

- 1 Visor

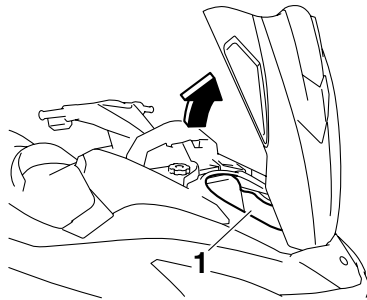

- 1 Front storage compartment

Front storage compartment:

Capacity:

66.0 L (17.4 US gal, 14.5 Imp.gal)

Load limit:

5.0 kg (11 lb)



# Features and functions

To close the front storage compartment, push down on the center of the hood until it latches securely.

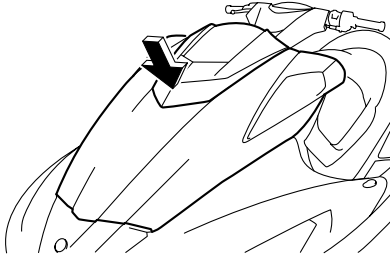

EJU35161

## Glove compartment

The glove compartment is located in front of the seat.

To open the glove compartment, turn the glove compartment knob, and then lift up the lid.

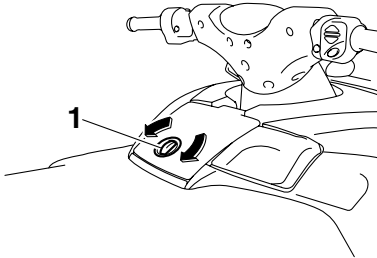

1 Glove compartment knob

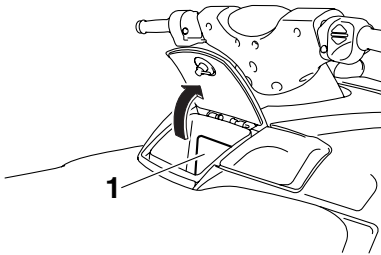

1 Glove compartment

Glove compartment:

Capacity:

5.9 L (1.6 US gal, 1.3 Imp.gal)

Load limit:

1.0 kg (2 lb)

To close the glove compartment, lower the lid, and then turn the glove compartment knob to lock the lid in place.

EJU31760

## Seat storage compartment

The seat storage compartment is located under the rear seat.

To open the seat storage compartment, remove the rear seat. (See page 25 for rear seat removal and installation procedures.)

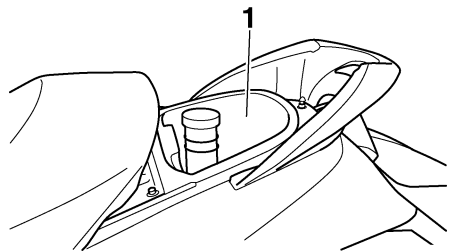
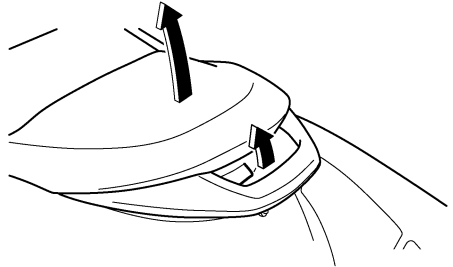

1 Seat storage compartment

Seat storage compartment:

Capacity:

15.0 L (4.0 US gal, 3.3 Imp.gal)

Load limit:

9.0 kg (20 lb)

# Features and functions

---

EJU35171

## Beverage holder

The beverage holder is located on the starboard (right) side of the watercraft.

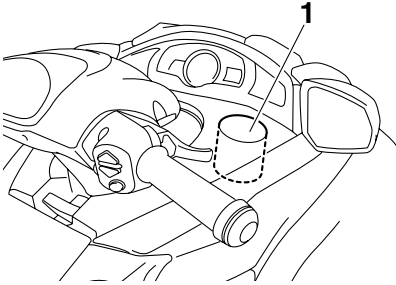

1 Beverage holder

Do not place beverages in the beverage holder when operating the watercraft.

EJU35184

## Watertight compartment

The watertight compartment is located on the port (left) side of the watercraft.

To open the watertight compartment, turn the cap counterclockwise.

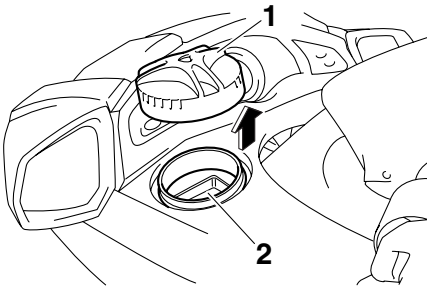

1 Watertight compartment cap

2 Watertight compartment

**Watertight compartment:**

Capacity:

2.7 L (0.7 US gal, 0.6 Imp. gal)

Load limit:

1.0 kg (2.2 lb)

To close the watertight compartment, turn the cap clockwise until it stops.

EJU31821

## Fuel and oil

EJU37222

### Fuel

EWJ00282

#### **WARNING**

- **Gasoline and gasoline vapors are extremely flammable. To avoid fires and explosions and to reduce the risk of injury when refueling, follow these instructions.**
- **Gasoline is poisonous and can cause injury or death. Handle gasoline with care. Never siphon gasoline by mouth. If you should swallow some gasoline, inhale a lot of gasoline vapor, or get some gasoline in your eyes, see your doctor immediately. If gasoline spills on your skin, wash with soap and water. If gasoline spills on your clothing, change your clothes.**

ECJ00321

#### **NOTICE**

- **Do not use leaded gasoline. Leaded gasoline can seriously damage the engine.**
- **Avoid getting water and contaminants in the fuel tank. Contaminated fuel can cause poor performance and engine damage. Use only fresh gasoline that has been stored in clean containers.**

Recommended fuel:

Regular unleaded gasoline with a minimum octane rating of

86

(Pump octane number) =  $(R + M)/2$

90 (Research octane number)

fuel meets the minimum octane ratings. E-85 is a fuel blend containing 85% ethanol and therefore must not be used in this watercraft. All ethanol blends containing more than 10% ethanol can cause fuel system damage or engine performance problems.

Yamaha does not recommend gasohol containing methanol because it can cause fuel system damage and engine performance problems.

To fill the fuel tank:

- (1) Before refueling, turn off the engine. Do not stand or sit on the watercraft. Never refuel while smoking, or while in the vicinity of sparks, open flames, or other sources of ignition.
- (2) Place the watercraft in a well-ventilated area and in a horizontal position.
- (3) Remove the seats, and then check the fuel level. (See page 25 for seat removal and installation procedures.)
- (4) Open the hood. (See page 26 for hood opening and closing procedures.)
- (5) Remove the fuel tank filler cap, and then slowly add fuel to the fuel tank. Stop filling when the fuel level reaches approximately 50 mm (2 in) from the top of the fuel tank. Do not overfill the fuel tank. Because fuel expands when it heats up, heat from the engine or the sun can cause fuel to spill out of the fuel tank. Do not leave the watercraft with a full tank in direct sunlight.

### Gasohol

There are two types of gasohol: gasohol containing ethanol and that containing methanol. Gasohol containing ethanol can be used if ethanol content does not exceed 10% and the

# Operation

Fuel tank capacity:  
70 L (18.5 US gal, 15.4 Imp.gal)



1 Approximately 50 mm (2 in) from top of the fuel tank

- (6) Wipe up any spilled fuel immediately.
- (7) Install the fuel tank filler cap, and then close the hood. Make sure that the fuel tank filler cap and the hood are securely closed before operating the watercraft.
- (8) Install the seats. Make sure that the seats are securely installed before operating the watercraft.

EJU31891

## Engine oil

ECJ00281

### NOTICE

**Use only 4-stroke engine oil. Usage of 2-stroke engine oil could result in severe engine damage.**

Make sure that the engine oil is at the specified level. Add oil as necessary. (See page 56 for engine oil level checking procedures.) Use a combination of the recommended SAE and API engine oil classifications shown in the chart below.

SAE								API
-4	14	32	50	68	86	104	122	F
-20	-10	0	10	20	30	40	50	C
10W-30								SE SF SG SH SJ SL
10W-40								
						20W-40		
						20W-50		

EJU31980

## Pre-operation checks

EJU31991

### Pre-operation check list

Before operating this watercraft, perform the checks in the following check list.

EWJ00411



**Failure to inspect or maintain the watercraft properly increases the possibility of an accident or damage to the watercraft. Do not operate the watercraft if you find any problem. If a problem cannot be corrected by the procedures provided in this manual, have the watercraft inspected by a Yamaha dealer.**

ITEM	ROUTINE	PAGE
<b>BEFORE LAUNCH OR OPERATION</b>		
<b>Engine compartment</b>	Remove the seats to ventilate the engine compartment. Check for fuel vapors and loose electrical connections.	56
<b>Bilge</b>	Check for water and fuel and drain if necessary.	58
<b>Stern drain plugs</b>	Check for proper installation.	58
<b>Throttle lever</b>	Check that the throttle lever springs back smoothly.	59
<b>Steering system</b>	Check for proper operation. Check that the handlebars are locked in place.	60
<b>Shift lever and reverse gate</b>	Check for proper operation.	60
<b>QSTS</b>	Check for proper operation.	61
<b>Fuel and oil</b>	Check the fuel and oil levels and replenish if necessary. Check the hoses and tanks for leakage.	56, 56
<b>Water separator</b>	Check for water and drain if necessary.	57
<b>Battery</b>	Check the electrolyte level and battery condition.	58
<b>Hood</b>	Check that the hood is securely closed.	26
<b>Front and rear seats</b>	Check that the seats are securely installed.	25
<b>Hull and deck</b>	Check the hull and deck for cracks and other damage.	56
<b>Jet intake</b>	Check for debris and remove if necessary.	62
<b>Fire extinguisher</b>	Check the condition and replace if necessary.	59
<b>Engine shut-off cord (lanyard)</b>	Check the condition and replace if frayed or broken.	62
<b>Switches</b>	Check the start switch, engine stop switch, and engine shut-off switch for proper operation.	62
<b>AFTER LAUNCH</b>		
<b>Cooling water pilot outlet</b>	Check that water is discharged while the engine is running and the watercraft is in the water.	63
<b>Multifunction information center</b>	Check for warning indications and proper operation.	63

# Operation

---

**TIP:**

Pre-operation checks should be made each time the watercraft is used. These checks can be completed in a short time. It is worth the time spent to ensure safety and reliability.

EJU32280

## Pre-operation check points

EJU32331

### Engine compartment

EWJ00460

#### **WARNING**

**Failure to ventilate the engine compartment could result in a fire or explosion. Do not start the engine if there is a fuel leak or a loose electrical connection.**

Ventilate the engine compartment before each use.

To ventilate the engine compartment, remove the seats. (See page 25 for seat removal and installation procedures.) Leave the engine compartment open for a few minutes to allow any fuel vapors to escape.

While the engine compartment is open, check for loose electrical connections.

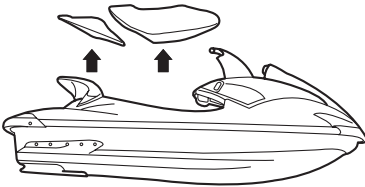

EJU32350

### Hull and deck

Check the hull and deck for cracks and other damage. If any damage is found, have a Yamaha dealer repair the watercraft.

EJU36871

### Fuel level

Make sure that there is sufficient fuel in the fuel tank before each use.

Also, check the fuel system for leakage, cracks, and malfunctions. (See page 83 for check points and correct procedures.)

- (1) Open the hood and remove the fuel tank filler cap to release any pressure that

might have built up in the fuel tank. (See page 26 for hood opening and closing procedures.)

- (2) Remove the seats. (See page 25 for seat removal and installation procedures.)
- (3) Check the fuel level in the fuel tank and replenish if necessary. (See page 52 for filling procedures.)
- (4) Install the fuel tank filler cap, and then close the hood and install the seats.

EJU36882

### Engine oil level

Check the engine oil level before each use.

EWJ00340

#### **WARNING**

**Engine oil is extremely hot immediately after the engine is turned off. Coming in contact with or getting any engine oil on your clothes could result in burns.**

ECJ01001

#### **NOTICE**

**Make sure that debris and water do not enter the oil filler hole. Debris and water in the engine oil can cause serious engine damage.**

To check the engine oil level:

- (1) Place the watercraft in a precisely level position on land with the engine stopped.

#### **TIP:**

If the engine was running, allow the engine oil to settle by waiting 5 minutes or more before checking the oil level.

- (2) Remove the seats. (See page 25 for seat removal and installation procedures.)
- (3) Remove the dipstick, wipe it clean, and then insert it back into the dipstick tube completely. Remove the dipstick again and check that the engine oil level is be-

# Operation

tween the minimum and maximum level marks.

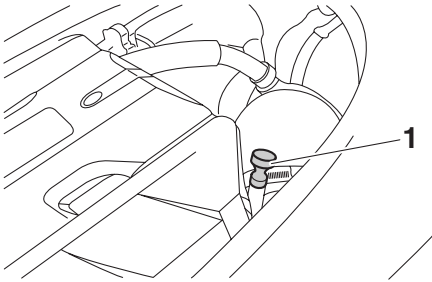

1 Dipstick

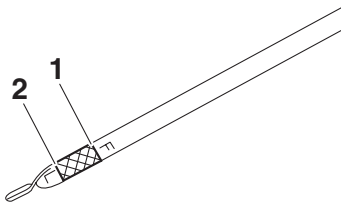

- 1 Maximum level mark
- 2 Minimum level mark

(4) If the engine oil level is below the minimum level mark, perform steps 5–7 to add enough oil so that the oil level is between the minimum and maximum level marks on the dipstick. If the engine oil level is significantly above the maximum level mark, have a Yamaha dealer service the watercraft.

(5) Remove the engine oil filler cap.

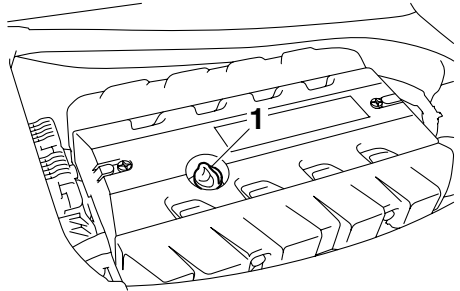

1 Engine oil filler cap

(6) Pour engine oil into the filler hole. Wait approximately 5 minutes until the engine oil settles.

## TIP:

The difference between the minimum and maximum level marks on the dipstick is equal to approximately 1 liter of engine oil.

- (7) Repeat steps 3–6 until the engine oil is at the proper level.
- (8) Install the engine oil filler cap, and then install the seats.

EJU32420

## Water separator

Check the water separator for water. The water separator retains any water that may have entered through the fuel tank breather hose if the watercraft was capsized. Normally, the water separator is empty.

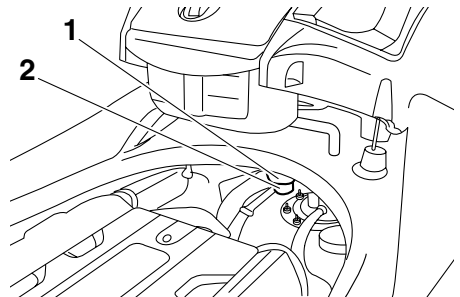

- 1 Water separator
- 2 Drain screw



If water remains in the water separator, drain it by removing the drain screw. Place a drain pan under the water separator to catch the draining water or use a dry cloth to soak up any water that could spill into the watercraft. If any water spills into the watercraft, be sure to wipe it up with a dry cloth. Also, be sure to install the drain screw after draining the water separator.

EJU32452

## Bilge

Check the bilge for moisture and fuel residue.

**NOTICE: Excessive water in the engine compartment can splash into the engine, which can result in severe damage.** [ECJ00341]

This watercraft is equipped with a conventional jet vacuum bilge draining system and an electric bilge draining system. The electric bilge draining system is operated when the engine is running. When excess water reaches the water inlet of the electric bilge pump, the water is discharged from the electric bilge pilot outlet at the stern.

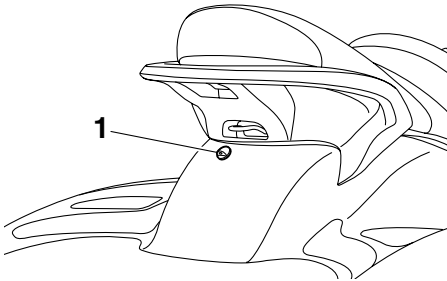

1 Electric bilge pilot outlet

A small quantity of water will remain in the bilge and should be drained manually. To drain any residual water, beach the watercraft and perform the following procedure.

To drain water from the bilge:

- (1) Remove the stern drain plugs.
- (2) Raise the bow of the watercraft until the water drains.

- (3) After the water has drained, wipe the bilge with dry rags to make sure that it is thoroughly dry.

- (4) Install the stern drain plugs. **NOTICE: Before installing the stern drain plugs, clean the drain plug threads to remove any foreign materials, such as dirt or sand. Otherwise, the stern drain plugs could be damaged, allowing water to enter the engine compartment. Make sure that the stern drain plugs are tightened securely before launching the watercraft. Otherwise, water may flood the engine compartment and cause the watercraft to submerge.**

[ECJ00361]

EJU32472

## Stern drain plugs

Check the stern drain plugs for proper installation.

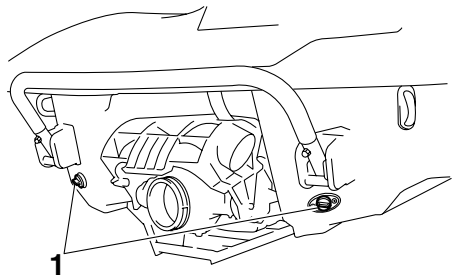

1 Stern drain plugs

EJU32482

## Battery

Check the battery electrolyte level and check that the battery has sufficient power to start the engine easily. **WARNING! Never operate the watercraft if the battery does not have sufficient power to start the engine or if it shows any other signs of decreased power. Loss of battery power may leave you stranded.** [EWJ01240]

# Operation

Recharge the battery or replace it if it is not in good condition. (See page 89 for battery recharging procedures.)

Also, check that the battery leads are tightened securely and that there is no corrosion on the battery terminals. Check that the breather hose is securely connected to the battery and that it is not pinched. **WARNING! Fire or explosion could result if the breather hose is damaged, obstructed, or not connected properly.** [EJWJ00451]

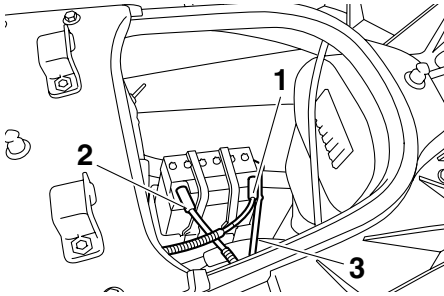

- 1 Positive (+) battery terminal: Red lead
- 2 Negative (-) battery terminal: Black lead
- 3 Breather hose

Make sure that the battery is securely held in place.

EJU32581

## Fire extinguisher

Check that there is a full fire extinguisher on board.

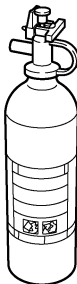

The fire extinguisher container is located in the seat storage compartment.

To open the fire extinguisher container, turn the cap counterclockwise.

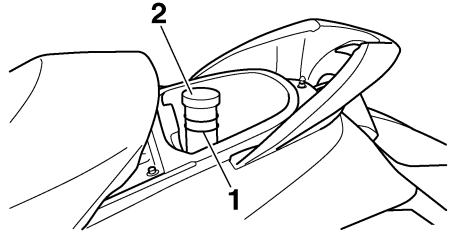

- 1 Fire extinguisher container
- 2 Fire extinguisher container cap

To close the fire extinguisher container, insert the fire extinguisher into the container, and then install the cap and tighten it securely.

To check the fire extinguisher, see the instructions supplied by the fire extinguisher manufacturer. Always keep the fire extinguisher in the fire extinguisher container.

Always carry a fire extinguisher on board. A fire extinguisher is not standard equipment with this watercraft. If you do not have one, contact a Yamaha dealer or a fire extinguisher dealer to obtain one meeting the proper specifications.

EJU32591

## Throttle lever

Check the throttle lever for proper operation. Squeeze and release the throttle lever several times to make sure that there is no hesitation in its travel. It should be smooth over the com-

plete range and spring back to the idle position when released.

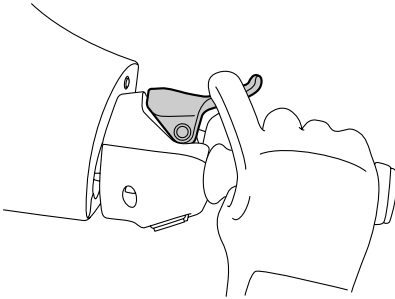

EJU32611

## Steering system

Check the handlebars for looseness.

Turn the handlebars as far as possible to the right and left to make sure that operation is smooth and unrestricted throughout the whole range. Also, make sure that the jet thrust nozzle moves as the handlebars are turned, and that there is no free play between the handlebars and the jet thrust nozzle.

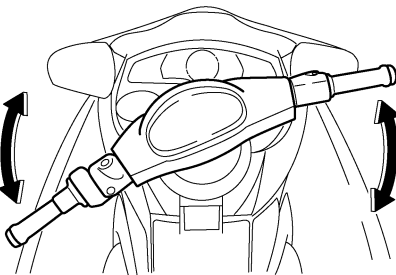

Push the handlebars back and forth to check that the tilt lever and handlebars are locked in

place. (See "Tilt lever" on page 30 for more information.)

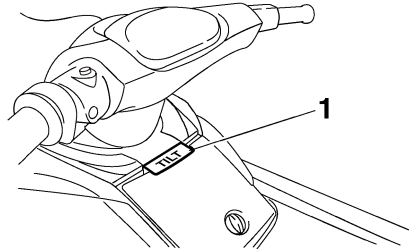

1 Tilt lever

EJU36581

## Shift lever and reverse gate

EWJ00031

### **WARNING**

**Do not touch the reverse gate while the shift lever is being operated, otherwise you could be pinched.**

Check the shift lever and reverse gate for proper operation.

Make sure that the reverse gate goes down completely when the shift lever is pulled up.

# Operation

Also, make sure that the reverse gate goes up completely when the shift lever is pushed down.

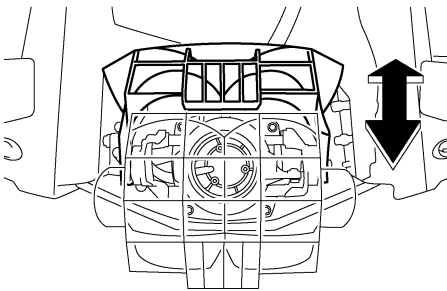
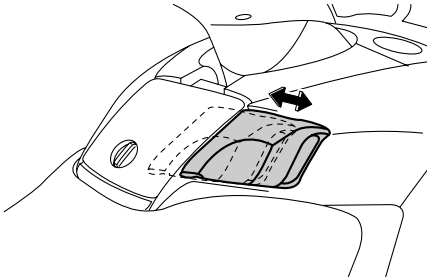

EJU32641

## Quick Shift Trim System (QSTS)

Operate the QSTS selector lock lever and the QSTS selector several times to check that they operate properly.

- (1) Squeeze the QSTS selector lock lever and check that it returns smoothly to its original position when released.

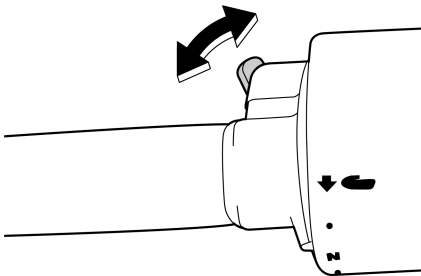

- (2) Check that the QSTS selector turns smoothly when the lever is squeezed and check that the selector locks in place at each position when the lever is released.

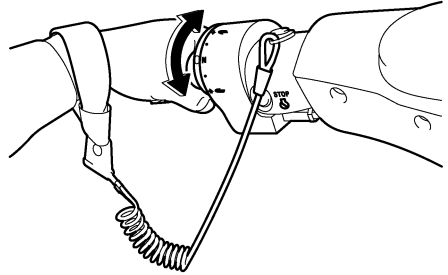

- (3) Check that the angle of the jet thrust nozzle changes when the QSTS selector is shifted from neutral to bow up or bow down.

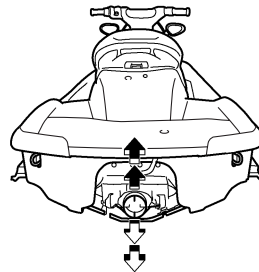
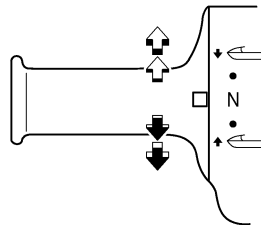

If the mechanism does not work properly, have a Yamaha dealer service it.

EJU32651

## Jet intake

Carefully check the jet intake for weeds, debris, or anything else that might restrict the intake of water. If the jet intake is clogged, clean it. (See page 95 for jet intake cleaning procedures.)

If the watercraft is operated while the jet intake is clogged, cavitation could occur, reducing jet thrust, and possibly damaging the jet pump. In some cases, the engine may overheat because of lack of cooling water, and damage to the engine could result. Cooling water is fed to the engine by the jet pump.

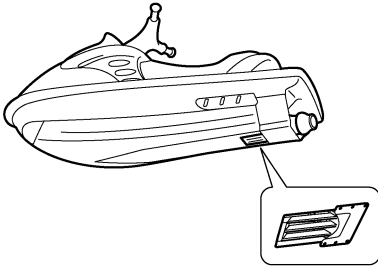

EJU32661

## Engine shut-off cord (lanyard)

Check that the engine shut-off cord (lanyard) is not frayed or broken. If the cord is damaged, replace it. **WARNING! Never try to repair the engine shut-off cord (lanyard) or tie it together. The engine shut-off cord (lanyard) may not pull free when the operator falls off, allowing the watercraft to**

**continue to run and cause an accident.**

[EWJ01220]

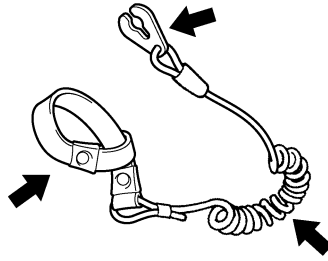

EJU32671

## Switches

ECJ00410

### NOTICE

**Do not run the engine for more than 15 seconds when checking the switches on land without supplying water, otherwise the engine could overheat.**

Check the start switch, the engine stop switch, and the engine shut-off switch for proper operation.

Push the start switch to start the engine. As soon as the engine starts running, push the engine stop switch to verify that the engine stops immediately. Restart the engine, and then pull the engine shut-off cord (lanyard) to remove the clip from the engine shut-off switch to verify that the engine stops immediately. (See pages 27 to 28 for information on proper operation of the start switch, the en-

# Operation

gine stop switch, and the engine shut-off switch.)

operation of the multifunction information center.)

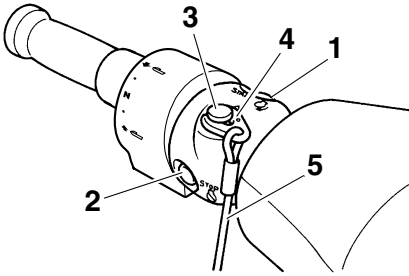

- 1 Start switch
- 2 Engine stop switch
- 3 Engine shut-off switch
- 4 Clip
- 5 Engine shut-off cord (lanyard)

EJU36890

## Cooling water pilot outlets

Check that water comes out from the port (left) cooling water pilot outlets while the engine is running and the watercraft is in the water. (See page 29 for more information.)

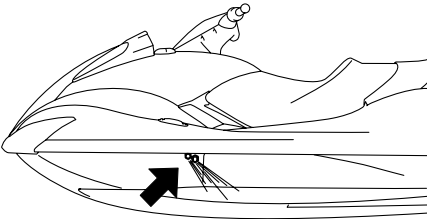

EJU32711

## Multifunction information center

Check the multifunction information center for proper operation while the watercraft is in the water. (See page 39 for information on proper



EJU32742

## Operation

EWJ00510

### **WARNING**

Before operating your watercraft, become familiar with all of the controls. Consult a Yamaha dealer about any control or function that you do not fully understand. Failure to understand how the controls work could cause an accident or prevent you from avoiding an accident.

ECJ00460

### **NOTICE**

Make sure that the stern drain plugs are tightened securely before launching the watercraft.

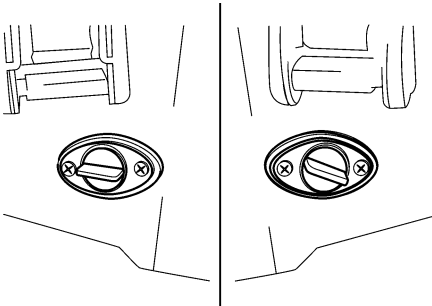

EJU36661

### **Engine break-in**

ECJ00430

### **NOTICE**

Failure to follow the engine break-in procedure could result in reduced engine life or even severe engine damage.

The engine break-in period is essential to allow the various components of the engine to wear and polish themselves to the correct operating clearances. This ensures proper performance and promotes longer component life.

### **TIP:**

Be sure to check the engine oil level before operating the watercraft for the first time. (See page 56 for engine oil checking procedures.)

- (1) Launch the watercraft and start the engine. (See page 64 for engine starting procedures.)
- (2) For the first 5 minutes, run the engine at trolling speed only. For the 30 minutes of operation after that, keep the engine speed below 5000 r/min. For the 1 hour of operation after that, keep the engine speed below 6000 r/min.
- (3) Proceed with normal operation.

EJU32801

### **Launching the watercraft**

When launching the watercraft, make sure that there are no obstacles behind you.

Use the remote control transmitter to select the unlock mode. (See page 35 for Yamaha Security System lock and unlock mode selection procedures.)

After the watercraft is in the water, start the engine. Shift into reverse and move the watercraft back slowly. If there are waves, someone should make sure that the watercraft is not pushed into the trailer before backing away.

EJU36341

### **Starting the engine**

- (1) If the lock mode of the Yamaha Security System is selected, use the remote control transmitter to select the unlock mode. (See page 35 for Yamaha Security System lock and unlock mode selection procedures.)
- (2) Launch the watercraft in water free from weeds and debris and at least 60 cm (2 ft) deep from the bottom of the watercraft.  
**NOTICE: Never operate in water that is less than 60 cm (2 ft) deep from the bottom of the watercraft, otherwise**

# Operation

pebbles or sand could be sucked into the jet intake, causing impeller damage and engine overheating. [ECJ00471]

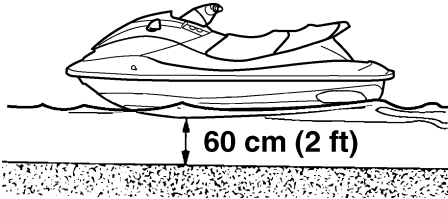

- (3) Attach the engine shut-off cord (lanyard) to your left wrist, and then attach the clip to the engine shut-off switch. It is not possible to start the engine with the clip removed from the engine shut-off switch. **WARNING! Check that the engine shut-off cord (lanyard) is attached correctly. If the engine shut-off cord (lanyard) is not attached correctly, it may not pull free when the operator falls off, allowing the watercraft to continue to run and cause an accident.** [EWJ00581]

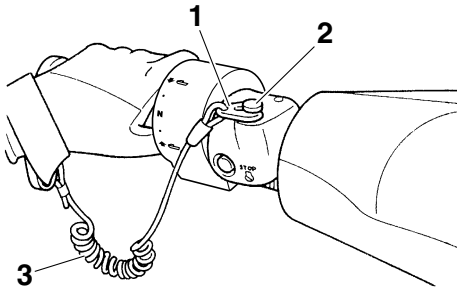

- 1 Clip
- 2 Engine shut-off switch
- 3 Engine shut-off cord (lanyard)

- (4) Push the start switch (green button), and then release it as soon as the engine starts to run. If the engine does not start

in 5 seconds, release the start switch, wait 15 seconds, and then try again. The engine will not start if the throttle lever is squeezed. **NOTICE: Never push the start switch while the engine is running. Do not operate the start switch for more than 5 seconds, otherwise the battery will be discharged and the engine will not start. Also, the starter motor could be damaged.** [ECJ01040]

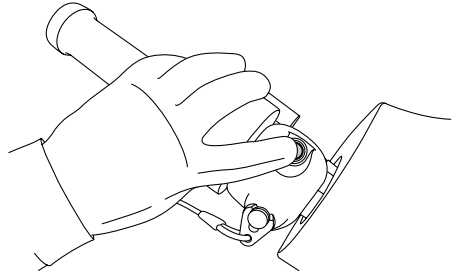

EJU32861

## Stopping the engine

To stop the engine, release the throttle lever, and then push the engine stop switch (red button). **WARNING! You need throttle to steer. Shutting the engine off can cause you to hit an obstacle you are attempting to avoid. A collision could result in severe injury or death.** [EWJ00601]

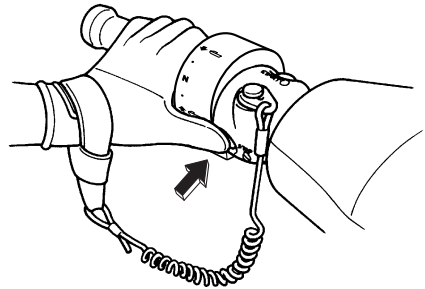



EJU37181

## Shifting

EWJ01230

### **WARNING**

- Do not use the reverse function to slow down or stop the watercraft as it could cause you to lose control, be ejected, or impact the handlebars.
- Make sure that there are no obstacles or people behind you before shifting into reverse.
- Do not touch the reverse gate while the shift lever is being operated, otherwise you could be pinched.

#### To shift into reverse:

- (1) Release the throttle lever and let the engine speed return to idle.
- (2) Pull the shift lever toward you.

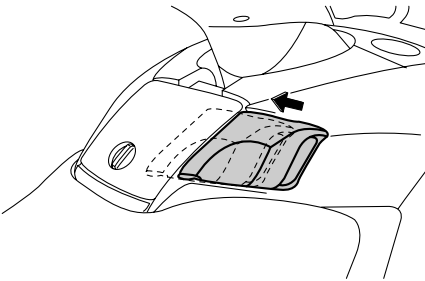

#### To shift into forward:

- (1) Release the throttle lever and let the engine speed return to idle.

- (2) Push the shift lever away from you.

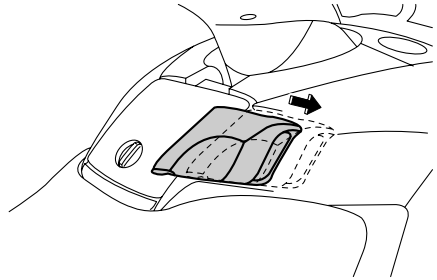

EJU32882

## Leaving the watercraft

If leaving the watercraft, select the lock mode of the Yamaha Security System and remove the engine shut-off cord (lanyard) to reduce the chance of accidental starting or unauthorized use by children or others. (See page 35 for Yamaha Security System lock and unlock mode selection procedures.)

# Operation

EJU32901

## Operating your watercraft

EJU32961

### Getting to know your watercraft

Operating your watercraft requires skills acquired through practice over a period of time. Take the time to learn the basic techniques well before attempting more difficult maneuvers.

Operating your new watercraft can be a very enjoyable activity, providing you with hours of pleasure. However, it is essential to familiarize yourself with the operation of the watercraft to achieve the skill level necessary to enjoy riding safely.

Before operating this watercraft, read this owner's/operator's manual, the Riding Practice Guide, the Riding Instruction card, and all labels on the watercraft. Pay particular attention to the safety information on page 10. These materials should give you an understanding of the watercraft and its operation. Remember: This watercraft is designed to carry the operator and up to 2 passengers. Never exceed the maximum load limit or allow more than 3 persons (or 2 persons if a water-skier is being pulled) to ride the watercraft at any time.

Maximum load:  
240 kg (530 lb)  
Load is the total weight of cargo, operator, and passengers.

EJU33001

### Learning to operate your watercraft

Before operating the watercraft, always perform the pre-operation checks listed on page 54. The short time spent checking the watercraft will reward you with added safety and reliability.

Check local laws before operating your watercraft.

Operate defensively at safe speeds and keep a safe distance away from people, objects, and other watercraft. Select a wide area to learn in, where there is good visibility and light boat traffic.

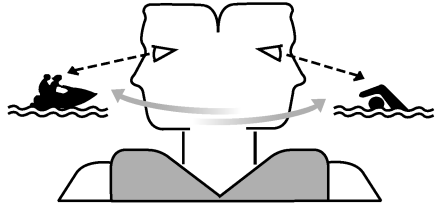

Use the buddy system—operate with someone nearby. Scan constantly for people, objects, and other watercraft. Be alert for conditions that limit your visibility or block your vision of others.

Attach the engine shut-off cord (lanyard) to your left wrist and keep it free from the handlebars so that the engine stops if you, the operator, fall off.

Wear a personal flotation device (PFD). All riders must wear a PFD that is approved by the appropriate authorities and is suitable for personal watercraft use.

Wear protective clothing. Severe internal injuries can occur if water is forced into body cavities as a result of falling into the water or being near the jet thrust nozzle. Normal swimwear does not adequately protect against forceful water entry into the rectum and vagina. All riders must wear a wetsuit bottom or clothing that provides equivalent protection. Such clothing includes thick, tightly woven, sturdy and snug-fitting apparel such as denim, but does not include spandex or similar fabrics, like those used in bicycle shorts. A full wetsuit can also protect against hypothermia

(subnormal body temperature) and abrasions.

Footwear and gloves are recommended.

Eye protection is recommended to keep wind, water, and glare from the sun out of your eyes while you operate your watercraft. Restraining straps for eyewear are made which are designed to float should your eyewear fall in the water.

You should grip the handlebars firmly and keep both feet on the floor of the footwell. Do not attempt to ride with passengers until your operating skills are fully developed.

EJU33061

## Riding with passengers

EWJ00541

### **WARNING**

- **Do not apply throttle when anyone is at the rear of the watercraft. Turn the engine off or keep it at idle. Water and debris exiting the jet thrust nozzle can cause severe injury. Passengers should not attempt to board the watercraft if the operator is applying throttle.**
- **When passengers are on board, make sure that they are holding on firmly and have their feet on the floor of the footwell before you start to accelerate.**

When 2 or 3 persons (including the operator) are on board, the watercraft handles differently, and is not as easy to maneuver, therefore operating it requires a higher degree of skill. Before attempting to operate the watercraft with passengers on board, the operator must practice operating the watercraft alone enough to be able to acquire the necessary skills.

The passengers must always wear a PFD that is approved by the appropriate authorities and a wetsuit bottom or equivalent.

Do not give a ride to children whose feet cannot reach the floor of the footwell. The passengers should hold on firmly, either to the person in front of them or to the handgrip provided, and keep their feet on the floor of the footwell. Never allow a passenger to ride in front of the operator.

When pulling a water-skier, the spotter should face to the rear while holding the handgrip with both hands. The spotter should always sit astride the seat with both feet placed firmly on the floor of the footwell for proper balance. Follow all local laws regarding water-skiing, such as those for skier-down flags, rearward-facing spotter, and other requirements.

EJU33081

## Starting the watercraft

EWJ00711

### **WARNING**

**To avoid collisions:**

- **Scan constantly for people, objects, and other watercraft. Be alert for conditions that limit your visibility or block your vision of others.**
- **Operate defensively at safe speeds and keep a safe distance away from people, objects, and other watercraft.**
- **Do not follow directly behind watercraft or other boats. Do not go near others to spray or splash them with water. Avoid sharp turns or other maneuvers that make it hard for others to avoid you or understand where you are going. Avoid areas with submerged objects or shallow water.**
- **Take early action to avoid collisions. Remember, watercraft and other boats do not have brakes. Do not release the**

# Operation

throttle lever when trying to steer away from objects—you need throttle to steer.

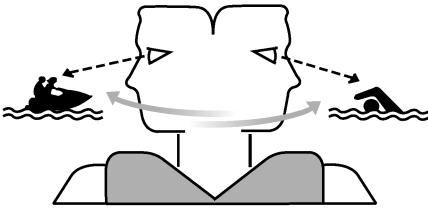

EJU33092

## Boarding and starting in shallow water

- (1) Launch the watercraft in water free from weeds and debris and at least 60 cm (2 ft) deep from the bottom of the watercraft.  
**NOTICE:** Never operate in water that is less than 60 cm (2 ft) deep from the bottom of the watercraft, otherwise pebbles or sand could be sucked into the jet intake, causing impeller damage and engine overheating. [ECJ00471]

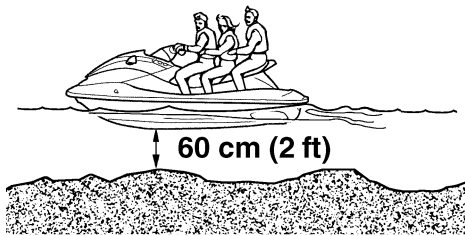

- (2) Board the watercraft from the side or the rear.
- (3) Attach the engine shut-off cord (lanyard) to your left wrist, and then attach the clip to the engine shut-off switch.
- (4) Grip the handlebars with both hands, place both feet on the floor of the footwell,

start the engine, and then look in all directions before starting off.

EJU33111

## Boarding and starting from a dock

- (1) Board the watercraft from the side.
- (2) Attach the engine shut-off cord (lanyard) to your left wrist, and then attach the clip to the engine shut-off switch.
- (3) Push the watercraft away from the dock, grip the handlebars with both hands, place both feet on the floor of the footwell, start the engine, and then look in all directions before starting off.

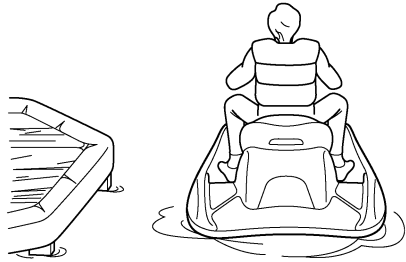

EJU36081

## Boarding and starting in deep water

EWJ01111

### **WARNING**

Be sure the operator and any passengers have practiced boarding from the water while still close to shore before riding. A person who has made many unsuccessful attempts to get back on the watercraft may become fatigued and suffer from exposure, increasing the risk of injury and drowning.

Boarding in deep water requires more skill. The operator and passengers should practice boarding in shallow water before riding in deep water.

EJU36351

## Boarding alone

- (1) Swim to the rear of the watercraft and place both hands on the boarding platform, pull yourself up, and then grasp the handgrip with one hand.

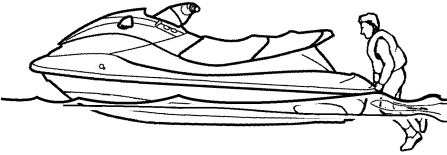

- (2) Pull yourself up to a kneeling position on the platform, and then move to the seat and sit astride.

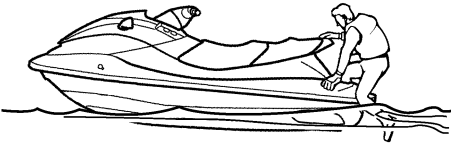

- (3) Attach the engine shut-off cord (lanyard) to your left wrist, and then attach the clip to the engine shut-off switch.
- (4) Grip the handlebars with both hands, place both feet on the floor of the footwell,

start the engine, and then look in all directions before starting off.



### TIP:

This watercraft is equipped with a reboarding step, which you can lower to make reboarding easier. The step returns automatically to the up position after you have boarded.

EJU33164

## Boarding with passengers

EWJ00660

### **WARNING**

Severe internal injuries can occur if water is forced into body cavities as a result of being near the jet thrust nozzle. Do not apply throttle until the passengers are seated with their feet on the floor of the footwell and are securely holding on to the person in front of them or to the handgrip provided.

### TIP:

The heavier the total weight of the operator and passengers, the more difficult it will be to balance the watercraft. Do not operate the watercraft when the total weight exceeds 240 kg (530 lb) including any cargo.

# Operation

---

- (1) Climb on board as noted in the previous section, and sit astride the seat.

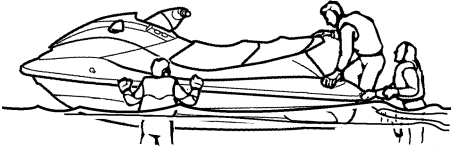

both the passengers and the operator should try to balance the watercraft.



- (2) Attach the engine shut-off cord (lanyard) to your left wrist, and then attach the clip to the engine shut-off switch.
- (3) Have the passengers move to the rear of the watercraft.

- (5) Check that the passengers have their feet on the floor of the footwell and are securely holding on to the person in front of them or to the handgrip provided. Never allow a passenger to ride in front of the operator.

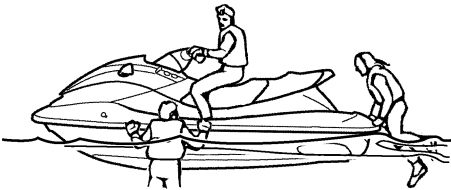

- (4) Have a passenger board and sit astride the seat. If a second passenger is boarding, have him or her follow the same procedure. When a passenger is boarding,

- (6) Start the engine, look in all directions, and then accelerate to planing speed.

To board when it is difficult to balance the watercraft at a standstill:

- (1) While the passengers are steadying the watercraft, pull yourself up onto the boarding platform into a kneeling posi-

tion, and then move to the seat and sit astride to balance the watercraft.

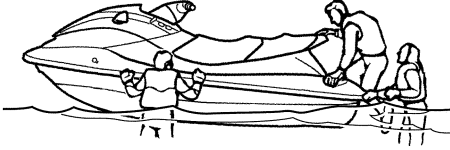

- (2) Have a passenger pull him or herself up onto the boarding platform into a kneeling position, then move to the seat and sit astride to balance the watercraft.
- (3) Attach the engine shut-off cord (lanyard) to your left wrist, and then attach the clip to the engine shut-off switch.
- (4) Start the engine and keep it at idle.
- (5) Have the second passenger pull him or herself up onto the boarding platform into a kneeling position, then crawl onto the seat as the watercraft accelerates.



- (6) Gradually increase the speed to balance the watercraft.



EJU33231

## Capsized watercraft

EWJ00671

### **WARNING**

**Improper uprighting can cause injury.**

- **Be sure to shut the engine off by pulling on the engine shut-off cord (lanyard) to remove the clip from the engine shut-off switch.**
- **Do not put your hands in the intake grate.**

If the watercraft capsizes, turn it over immediately.

Be sure to carefully follow the procedures below to prevent injury, or damage to the watercraft.

- (1) Remove the clip from the engine shut-off switch.
- (2) Swim to the rear of the watercraft. Pull the watercraft over with your left hand on the ride plate while pushing down on the gunwale with your right hand or foot.

If the port (left) side of the capsized watercraft is tilting up, push down on the gunwale so that the port (left) side is down before turning the watercraft clockwise. **NOTICE: Do not turn the watercraft over counterclockwise, otherwise water can enter the engine,**

# Operation

which can result in severe damage.

[ECJ00541]



- (3) Start the engine and operate the watercraft as straight as possible and above planing speed for at least 2 minutes to discharge any water remaining in the engine compartment. (If the engine does not start, see “Towing the watercraft” on page 98 or “Submerged watercraft” on page 98.) **NOTICE: Do not operate the engine at full throttle for at least 1 minute after the engine has been restarted. Excessive water in the engine compartment can splash into the engine, which can result in severe damage.** [ECJ00551]

EJU33251

## Turning the watercraft

EWJ00770



- Do not release the throttle lever when trying to steer away from objects—you

need throttle to steer. A collision could result in severe injury or death.

- When operating at higher speeds, make gradual turns or slow down before turning. Sharp high-speed turns may cause the watercraft to slide sideways or spin, throwing the operator and passengers overboard, which could cause an injury.

Steering control depends on the combination of handlebar position and the amount of throttle.

Water sucked in through the intake grate is pressurized by the impeller in the jet pump. As the pressurized water is expelled from the pump through the jet thrust nozzle, it creates thrust to move and steer the watercraft. The higher the engine speed, the more thrust produced.

The amount of jet thrust, in addition to the position of the handlebars, determines how sharply you turn.

- A. More throttle produces higher thrust, so the watercraft will turn more sharply.

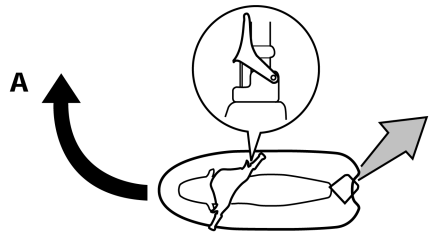



- B. Less throttle produces lower thrust, so the watercraft will turn more gradually.

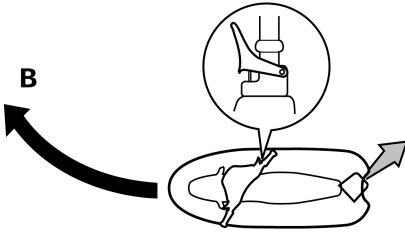

- C. Releasing the throttle lever completely produces only minimum thrust. If you are traveling at speeds above trolling, you will have rapidly decreasing ability to steer without throttle. You may still have some turning ability immediately after releasing the throttle lever, but once the engine slows down, the watercraft will no longer respond to handlebar input until you apply throttle again or you reach trolling speed.

At trolling speed, the watercraft can be turned gradually by handlebar position alone using just the amount of thrust available at idle.

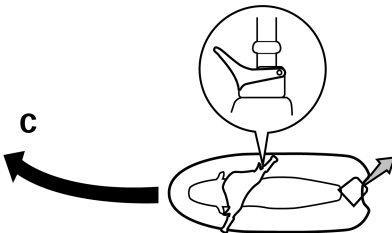

- D. If the engine is stopped while riding, there is no thrust. The watercraft will go straight even though the handlebars are turned.

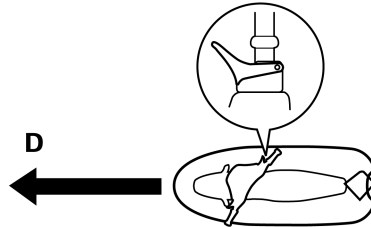

### You need throttle to steer.

This model is equipped with the Yamaha Engine Management System (YEMS) that includes an off-throttle steering (OTS) system. It will activate at planing speeds should you attempt to steer the watercraft after releasing the throttle lever (see condition C above).

The OTS system assists in turning by continuing to supply some thrust while the watercraft is decelerating, but you can turn more sharply if you apply throttle while turning the handlebars. The OTS system does not function below planing speeds or when the engine is off. Once the engine slows down, the watercraft will no longer turn in response to handlebar input until you apply throttle again or you reach trolling speed.

EJU33290

### Stopping the watercraft

The watercraft is not equipped with a separate braking system. It is stopped by water resistance when the throttle lever is released. From full speed, the watercraft comes to a complete stop in approximately 100 m (330 ft) after the throttle lever is released or the engine is stopped, although this distance will vary depending on many factors, including gross weight, water surface conditions, and wind direction. The watercraft slows down as

# Operation

soon as the throttle lever is released, but will coast for a distance before fully stopping. If you are not sure you can stop in time before hitting an obstacle, apply throttle and turn in another direction.

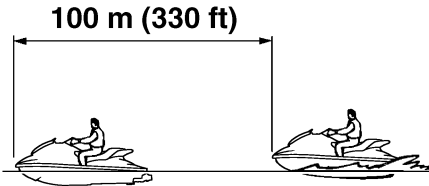

EWJ00740

## WARNING

- Allow adequate stopping distance.
- Take early action to avoid collisions. Remember, watercraft and other boats do not have brakes.
- Operate defensively at safe speeds and keep a safe distance away from people, objects, and other watercraft to give you time to stop.
- Do not shut the engine off when slowing down in case you need engine power to steer away from a boat or other obstacle that comes into your path.
- Do not use the reverse function to slow down or stop the watercraft as it could cause you to lose control, be ejected, or impact the handlebars.

EJU35961

## Beaching the watercraft

- (1) Make sure that there are no boats, swimmers, or obstacles near the beach. Release the throttle lever about 100 m (330 ft) before you reach the intended beaching area.

- (2) Approach the beach slowly and stop the engine before reaching land. Remember, you need throttle to steer.
- (3) Get off the watercraft and pull it up on the beach. **NOTICE: Small pebbles, sand, seaweed, and other debris can be sucked into the jet intake and impair or damage the impeller. Always stop the engine and get off the watercraft before beaching it.** [ECJ00491]

EJU36060

## Docking the watercraft

- (1) Make sure that there are no boats, swimmers, or obstacles near the watercraft. Reduce speed about 100 m (330 ft) away from the dock.
- (2) Slowly approach the dock and stop the engine just before coming alongside it.

EJU36671

## Reverse on waterways

Reverse can be used for slow-speed maneuvering when it is necessary to back up out of tight spots where you cannot turn around. Once the engine is idling, shift into reverse and gradually increase engine speed. Make sure that there are no obstacles or people behind you before shifting into reverse.

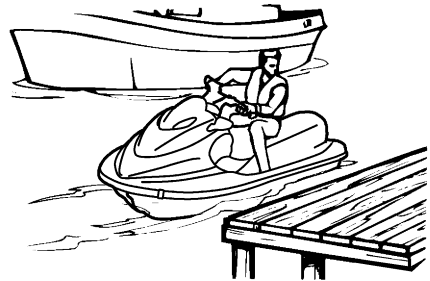

## TIP:

This model is equipped with a function which limits the engine speed in reverse.

EJU37190

## Operating in weeded areas

Always avoid operating your watercraft in areas where weed growth is thick. If traveling in weeded areas is unavoidable, operate the engine alternately at partial throttle and full throttle. Weeds tend to accumulate more at a steady speed and at trolling speed. If weeds clog the intake area and cause cavitation, clean the jet intake and impeller. (See page 95 for cleaning procedures.)

EJU37091

## Post-operation care

To keep your watercraft in top shape, always take it out of the water after using it and perform the following procedures. Leaving the watercraft in the water for extended periods will accelerate the rate of normal deterioration of the jet unit components and hull finish. Marine organisms and corrosion are some of the conditions that can adversely affect the life of many watercraft components.

- (1) Remove the watercraft from the water.
- (2) Wash down the hull, handlebars, and jet unit with fresh water.
- (3) Remove the seats and check the engine compartment for water. To drain excess water, remove the stern drain plugs, and then raise the bow of the watercraft enough to allow the water in the bilge to drain out.

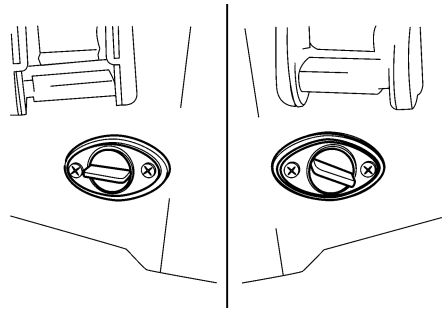

### TIP:

This watercraft is equipped with a jet vacuum bilge draining system and an electric bilge draining system that remove water from the engine compartment while you are underway. However, some residual water will remain, therefore remove the stern drain plugs to drain the water. (See page 58 for bilge draining procedures.)

- (4) Place the watercraft in a horizontal position.

# Operation

---

- (5) Flush the cooling system to prevent it from clogging with salt, sand, or dirt. (See page 78 for flushing procedures.)
- (6) Rinse the engine and engine compartment with a small amount of water.  
**NOTICE: Do not use high-pressure water when rinsing the engine or engine compartment as severe engine damage could result.** [ECJ00571]
- (7) Wipe the engine and engine compartment dry with a clean cloth (repeat step 3, if necessary).
- (8) Wipe the hull, handlebars, and jet unit dry with a clean cloth.
- (9) Spray a rust inhibitor on metallic parts to minimize corrosion.
- (10) Allow the engine compartment to air dry completely before installing the seats.

EJU33462

## Transporting

Before putting the watercraft on a trailer or transporting it, be sure to put the shift lever in the forward position. When transporting the watercraft on a trailer, secure the tie downs to the trailer through the bow eye and stern eyes. **NOTICE: Do not attach ropes or tie downs to any part of the watercraft other than the bow eye and stern eyes to secure the watercraft to the trailer. Otherwise, the watercraft may be damaged. Wrap the ropes or tie downs with towels or rags where they touch the body of the watercraft to avoid scratches or damage. Do not transport the watercraft with the shift lever in the reverse position. Otherwise, the reverse gate may hit an obstacle, which could cause damage.** [ECJ00642]

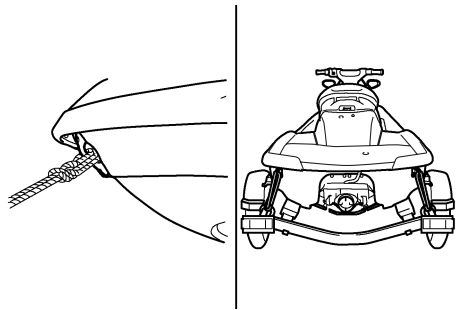

EJU33490

## Storage

EWJ00330

### **WARNING**

**Always place the watercraft upright in a horizontal position when storing it, otherwise fuel could leak out into the engine or engine compartment, which could create a fire hazard.**

Storage for long periods of time, such as winter storage, requires preventive maintenance to ensure against deterioration. It is advisable to have the watercraft serviced by a Yamaha dealer prior to storage. However, the following procedures can be performed by the owner.

EJU37202

### Flushing the cooling system

Flushing the cooling system is essential to prevent it from clogging with salt, sand, or dirt.

- (1) Place the watercraft in a horizontal position.
- (2) Remove the rear seat and seat storage compartment. (See page 25 for seat removal and installation procedures.)
- (3) Remove the flushing hose connector cap, and then insert the garden hose adapter into the flushing hose connector and turn it until it is securely connected.

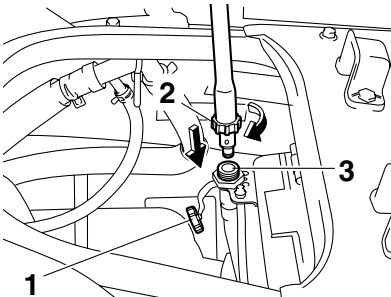

- 1 Flushing hose connector cap
- 2 Garden hose adapter
- 3 Flushing hose connector

- (4) Connect the garden hose adapter to a water tap using a garden hose.

### TIP:

A garden hose is not included.

- (5) Start the engine, and then immediately turn the water supply on until water flows out continually from the jet thrust nozzle.  
**NOTICE: Do not run the engine for more than 15 seconds without supplying water or over 4000 r/min on land, otherwise the engine could overheat.**

[ECJ01050]

### TIP:

If you will be storing the watercraft for a prolonged period, such as winter storage, top off the fuel tank with fresh gasoline and add fuel stabilizer and conditioner to the fuel tank according to the manufacturer's instruction before starting the engine.

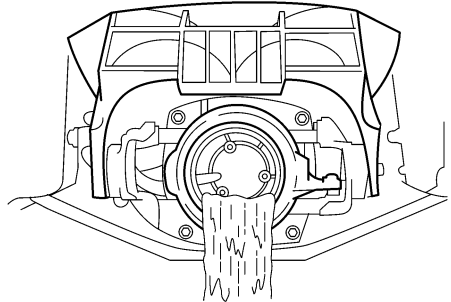

- (6) Run the engine at idling speed for about 3 minutes watching the engine condition. If the engine stops while flushing, turn the water supply off immediately and repeat the above steps. **NOTICE: Do not supply water to the cooling water passages when the engine is not running. The water could flow back through the muffler into the engine, causing severe engine damage.** [ECJ00122]
- (7) Turn the water supply off, and then force the remaining water out of the cooling

# Maintenance and care

water passages by alternately squeezing and releasing the throttle lever for 10 to 15 seconds.

- (8) Stop the engine.
- (9) Remove the garden hose adapter and install the flushing hose connector cap.
- (10) Install the seat storage compartment and the rear seat.

EJU36911

## Lubrication

- (1) Lubricate all cables such as the throttle and steering cables.

Use a suitable marine grease applicator to pressure-lubricate the cables and purge out any moisture between the inner and outer cables.

- (2) Lubricate the areas of the watercraft specified in "Lubrication points" on page 87.

EJU33681

## Battery

If the watercraft will not be used for more than a month, remove the battery from the watercraft and store it in a cool, dry place.

- (1) Disconnect the negative (–) battery lead first, then the positive (+) battery lead and breather hose, and then remove the battery from the watercraft.
- (2) Clean the battery casing using fresh water.
- (3) If the battery terminals are dirty or corroded, clean them with a wire brush.
- (4) Fully charge the battery.
- (5) Apply Yamaha Marine Grease or Yamaha Grease A to the battery terminals, and then store the battery in a cool, dry place.
- (6) Check the battery at least once every 2 months and fully charge it if necessary.

**NOTICE: Always keep the battery charged. Storing a discharged battery**

**can cause permanent battery damage.**

[ECJ00101]

To check the condition of the battery, check the specific gravity of the electrolyte or measure the voltage at both battery terminals. Charge the battery if the voltage is less than 12 volts.

Specific gravity (for reference): 1.28 at 20 °C (68 °F)
--

It is recommended to have a Yamaha dealer check the specific gravity and charge the battery. If you maintain the battery yourself, be sure to read and follow the instructions provided with the battery tester and charger you use.

EJU33731

## Cleaning the watercraft

Clean the watercraft before storing it for a long period.

- (1) Wash down the hull, handlebars, and jet unit with fresh water.
- (2) Rinse the engine and engine compartment with fresh water. Drain all of the water and wipe up any remaining moisture with clean, dry rags. **NOTICE: Do not use high-pressure water when rinsing the engine and engine compartment as severe engine damage could result.**

[ECJ00111]

- (3) Spray the engine's exterior with a rust inhibitor and lubricant.
- (4) Wax the hull with a non-abrasive wax.
- (5) Wipe all vinyl and rubber components, such as the seat and engine compartment seals, with a vinyl protectant.

EJU33762

## Maintenance and adjustments

Periodic inspection, adjustment, and lubrication will keep your watercraft in the safest and most efficient condition possible. Safety is an obligation of the watercraft owner. Proper maintenance must be carried out to keep the exhaust emission and sound levels within the regulated limits. The most important points of watercraft inspection, adjustment, and lubrication are explained on the following pages. See a Yamaha dealer for genuine Yamaha replacement parts and optional accessories designed for your watercraft.

Remember, failures that are the result of the installation of parts or accessories which are not qualitatively equivalent to genuine Yamaha parts are not covered by the limited warranty.

**Maintenance, replacement, or repair of the emission control devices and system may be performed by any marine SI engine repair establishment or individual. Warranty repair, however, must be performed at an authorized Yamaha marine dealership.**

EWJ00311

### **WARNING**

**Be sure to turn off the engine when you perform maintenance unless otherwise specified. If you are not familiar with machine servicing, this work should be done by a Yamaha dealer or other qualified mechanic.**

EJU33811

## Owner's/operator's manual and tool kit

It is advisable to always carry the owner's/operator's manual and tool kit with you whenever you use the watercraft. For your convenience, a storage compartment is provided on the watercraft for the manual and tool kit.

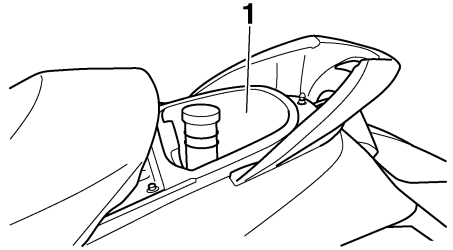

1 Storage compartment

To protect these materials from water damage, it would be a good idea to put them in a waterproof bag.

The service information included in this manual is intended to provide you, the owner, with the necessary information for completing your own preventive maintenance and minor repairs. The tools provided in the tool kit are sufficient for this purpose, except that a torque wrench may also be necessary to tighten nuts and bolts.

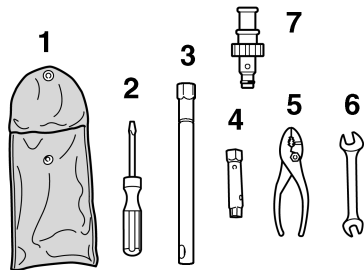

- 1 Tool bag
- 2 Screwdriver
- 3 16 mm box wrench
- 4 10/12 mm box wrench
- 5 Pliers
- 6 Open-end wrench
- 7 Garden hose adapter

# Maintenance and care

EJU37060

## Periodic maintenance chart

The following chart gives general guidelines for periodic maintenance. However, maintenance may need to be performed more frequently depending on your operating conditions.

This “●” mark indicates maintenance that you may do yourself.

This “○” mark indicates work to be done by a Yamaha dealer.

Item	Operation	Initial			Thereafter every		Page
		10 hours	50 hours	100 hours	100 hours	200 hours	
			6 months	12 months	12 months	24 months	
<b>Spark plugs</b>	Check, clean, adjust	●/○		●/○	●/○		86
<b>Lubrication points</b>	Lubricate			●/○	●/○		87
<b>Internal engine components</b>	Lubricate	○*2 50 hours or 12 months					—
<b>QSTS cables</b>	Lubricate			○	○		—
<b>Intermediate housing</b>	Lubricate	○		●/○	●/○		87
<b>Fuel system</b>	Check			○	○		83
<b>Fuel tank</b>	Check, clean			●/○	●/○		83
<b>Trolling speed</b>	Check, adjust			●/○	●/○		90
<b>Throttle shaft</b>	Check			○	○		—
<b>Cooling water passages</b>	Flush	●*1					78
<b>Water inlet strainer</b>	Check, clean			○	○		—
<b>Bilge strainer</b>	Clean			○	○		—
<b>Electric bilge pump strainer</b>	Check, clean			○	○		—
<b>Impeller</b>	Check			○	○		—
<b>Jet thrust nozzle angle</b>	Check, adjust			●/○	●/○		83
<b>Steering master</b>	Check	○		○	○		—
<b>QSTS mechanism</b>	Check, adjust	○		○	○		—
<b>Shift cable and reverse gate</b>	Check, adjust			●/○	●/○		84
<b>Throttle cable</b>	Check, adjust	○		●/○	●/○		84
<b>Stern drain plugs</b>	Check, replace			○	○		58



# Maintenance and care

Item	Operation	Initial			Thereafter every		Page
		10 hours	50 hours	100 hours	100 hours	200 hours	
			6 months	12 months	12 months	24 months	
<b>Battery</b>	Check, charge			●/○	●/○		89
<b>Rubber coupling</b>	Check					○	—
<b>Engine mount</b>	Check					○	—
<b>Nuts and bolts</b>	Check	○		○	○		—
<b>Air filter element</b>	Check			○	○		83
<b>Engine oil</b>	Replace	○	○ 50 hours or 12 months				83
<b>Oil filter</b>	Replace			○	○		83
<b>Valve clearance</b>	Check, adjust					○	—

\*1 This operation should be performed after every use.

\*2 This operation should be performed before long-term storage.

# Maintenance and care

EJU34212

## Checking the fuel system

EWJ00381

### **WARNING**

Leaking fuel can result in fire or explosion.

- Check for fuel leakage regularly.
- If any fuel leakage is found, the fuel system must be repaired by a qualified mechanic. Improper repairs can make the watercraft unsafe to operate.

Check the fuel system for leaks, cracks, and malfunctions. If any problem is found, consult a Yamaha dealer.

#### **Check:**

- Fuel tank filler cap and seal for damage
- Fuel in fuel tank for water and dirt
- Fuel tank for damage, cracks, and leakage
- Fuel hoses and joints for damage, cracks, and leakage
- Air bleeding passages for leakage

EJU34230

#### **Fuel tank**

Check the fuel tank for leakage and for water in the tank. If water is found in the fuel system, or if the fuel tank needs to be cleaned, have a Yamaha dealer service the watercraft.

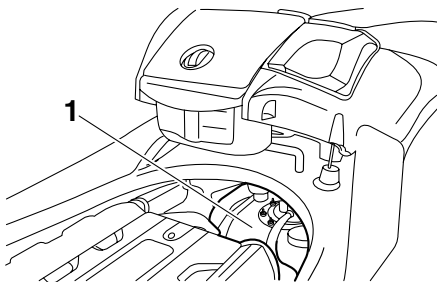

1 Fuel tank

EJU36951

## Engine oil and oil filter

EWJ00340

### **WARNING**

Engine oil is extremely hot immediately after the engine is turned off. Coming in contact with or getting any engine oil on your clothes could result in burns.

ECJ00991

### **NOTICE**

Do not run the engine with too much or not enough oil in the engine, otherwise the engine could be damaged.

It is recommended to have a Yamaha dealer change the engine oil. However, if you choose to change the oil on your own, consult a Yamaha dealer.

Recommended engine oil:  
SAE 10W-30, 10W-40, 20W-40, 20W-50  
Oil grade:  
API SE,SF,SG,SH,SJ,SL  
Oil quantity:  
With oil filter replacement:  
3.1 L (3.28 US qt, 2.73 Imp.qt)  
Without oil filter replacement:  
3.0 L (3.17 US qt, 2.64 Imp.qt)  
Total amount:  
4.3 L (4.55 US qt, 3.78 Imp.qt)

EJU34311

#### **Air filter element**

Have a Yamaha dealer check the air filter element at the intervals specified in the periodic maintenance chart.

EJU34321

#### **Checking the jet thrust nozzle angle**

Check the handlebars and jet thrust nozzle for smooth operation.

Turn the handlebars as far as possible to the right and left and check that the difference of distances A and B between the jet thrust nozzle and the nozzle is within specification.

Difference of A and B:  
Maximum 5 mm (0.20 in)

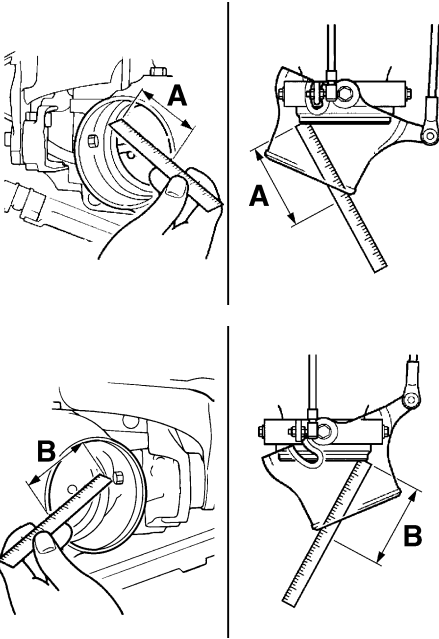

If the steering is stiff or misadjusted, have a Yamaha dealer service it.

EJU36590

## Checking the shift cable

Place the shift lever in the reverse position. Make sure that the reverse gate makes contact with the stopper.

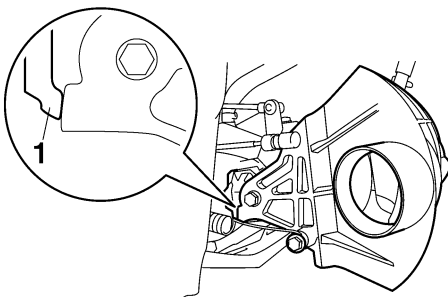

1 Stopper

If the reverse gate does not make contact with the stopper, have a Yamaha dealer service it.

EJU37030

## Checking and adjusting the throttle cable

Face the handlebars straight ahead, and then check that the throttle cable moves back to the set position smoothly and that the throttle lever free play is within specification.

Squeeze and release the throttle lever. If the throttle lever does not return smoothly, have a Yamaha dealer service it.

If the specified throttle lever free play cannot be obtained as described below, have a Yamaha dealer make the adjustment.

### FX SHO

- (1) Remove the eight screws, and then remove the front handlebar cover.

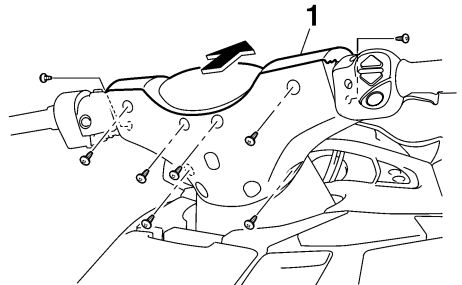

1 Front handlebar cover

- (2) Slide the rubber cover away from the adjuster, and then loosen the locknut.

# Maintenance and care

- (3) Make sure that the handlebars are facing straight ahead, and then adjust the free play by turning the adjuster.

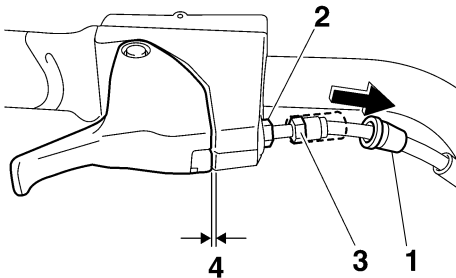

- 1 Rubber cover
- 2 Locknut
- 3 Adjuster
- 4 Throttle lever free play

Throttle lever free play:  
2.0–5.0 mm (0.08–0.20 in)

- (4) Hold the adjuster with one wrench while tightening the locknut with another wrench. Slide the rubber cover to its original position.
- (5) Install the front handlebar cover, and then install the eight screws.

## FX Cruiser SHO

- (1) Remove the ten screws, and then remove the front and rear handlebar covers.

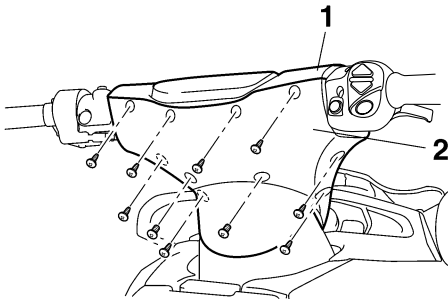

- 1 Front handlebar cover
- 2 Rear handlebar cover

- (2) Slide the rubber cover away from the adjuster, and then loosen the locknut.
- (3) Make sure that the handlebars are facing straight ahead, and then adjust the free play by turning the adjuster.

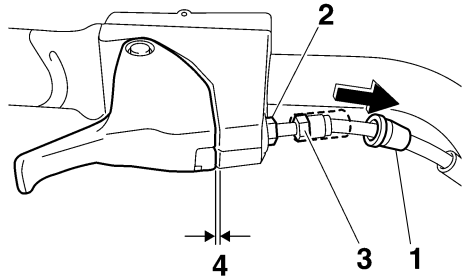

- 1 Rubber cover
- 2 Locknut
- 3 Adjuster
- 4 Throttle lever free play

Throttle lever free play:  
2.0–5.0 mm (0.08–0.20 in)

- (4) Hold the adjuster with one wrench while tightening the locknut with another wrench. Slide the rubber cover to its original position.

# Maintenance and care

- (5) Install the front and rear handlebar covers as shown in the illustration, and then install the ten screws.

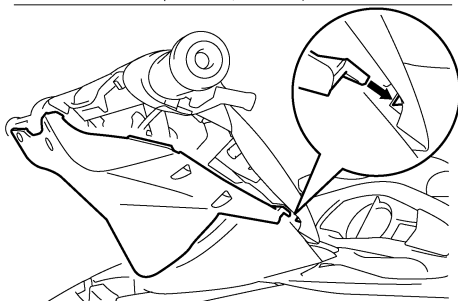
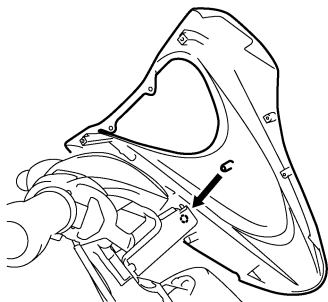

EJU37041

## Cleaning and adjusting the spark plugs

EWJ00350

### **WARNING**

**Be careful not to damage the insulator when removing or installing a spark plug. A damaged insulator could allow sparks to escape, which could result in a fire or explosion.**

The spark plug is an important engine component and is easy to inspect. The condition of the spark plug can indicate something about the condition of the engine. For example, if one spark plug has a distinctly different color, the engine could require servicing. Do not attempt to diagnose any problems yourself. Have a Yamaha dealer service the watercraft.

Remove and inspect the spark plugs periodically; heat and deposits will cause the spark plugs to slowly break down and erode. If electrode erosion becomes excessive, or if carbon and other deposits are excessive, replace the spark plug with the specified plug.

Specified spark plug:  
LFR6A

### To remove a spark plug:

- (1) Remove the seats. (See page 25 for seat removal and installation procedures.)
- (2) Remove the engine cover screws, and then remove the engine cover.

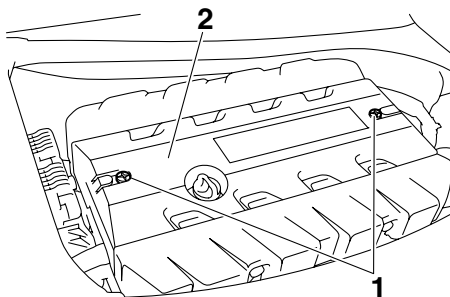

- 1 Engine cover screw  
2 Engine cover

- (3) Remove the spark plug cap bolts, and then remove the spark plug cap. **NOTICE:** Do not use any tools to remove or install the spark plug cap, otherwise the ignition coil coupler could be damaged. The spark plug cap may be difficult to remove because the rubber seal on the end of the cap fits tightly. To remove the spark plug cap, simply twist it back and forth while pulling it up; to install it, twist it back and forth while pushing it down. [ECJ00211]

# Maintenance and care

## TIP:

If removing the spark plug cap nearest the stern, remove the plastic tie that is securing the wiring harness before removing the cap.

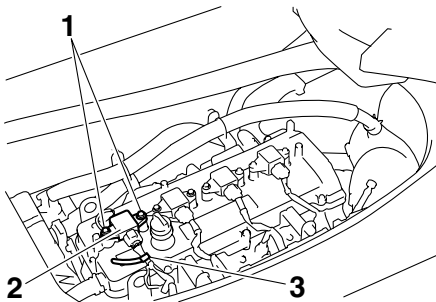

- 1 Spark plug cap bolt
- 2 Spark plug cap
- 3 Plastic tie

- (4) Remove the spark plug. Measure the spark plug gap with a wire thickness gauge. Replace the spark plug or adjust the gap to specification if necessary.

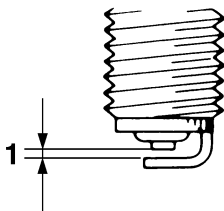

- 1 Spark plug gap

Spark plug gap:  
0.8–0.9 mm (0.031–0.035 in)

## To install a spark plug:

- (1) Clean the gasket surface.
- (2) Wipe any dirt from the threads of the spark plug.

- (3) Install the spark plug, and then tighten it to the specified torque.

Spark plug tightening torque:  
24.5 Nm (2.50 kgf-m, 18.1 ft-lb)

## TIP:

If a torque wrench is not available when you are installing a spark plug, a good estimate of the correct torque is 1/4 turn to 1/2 turn past finger tight using the spark plug wrench included in the tool kit. Have the spark plug adjusted to the correct torque with a torque wrench as soon as possible.

- (4) Wipe off any water on the spark plug or inside the spark plug cap, and then install the cap. Push the spark plug cap down until it is securely installed, and then install the spark plug cap bolts and tighten them to the specified torque.

If the spark plug cap nearest the stern was removed, secure the wiring harness by installing the plastic tie after installing the cap.

Spark plug cap bolt tightening torque:  
7.6 Nm (0.77 kgf-m, 5.6 ft-lb)

- (5) Install the engine cover and engine cover screws, and then install the seats.

EJU36970

## Lubrication points

To keep moving parts sliding or rotating smoothly, coat them with water-resistant grease.

Recommended water-resistant grease:  
Yamaha Marine Grease/Yamaha Grease A

- Throttle cable (handlebar end)  
Loosen the adjuster and disconnect the outer cable from the bracket. Spray a rust inhibitor into the outer cable. Connect the

# Maintenance and care

outer cable, and then adjust the throttle cable free play. (See page 84 for adjustment procedures.)

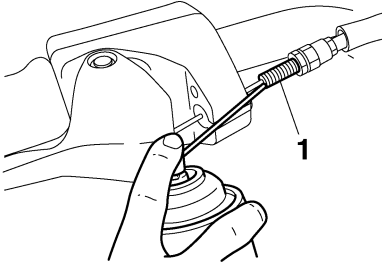

1 Adjuster

- Steering cable (handlebar end)

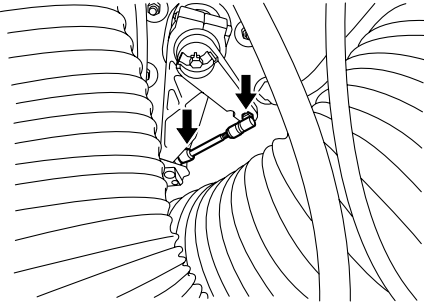

- Steering cable (jet thrust nozzle end)
- QSTS rod (jet thrust nozzle end)

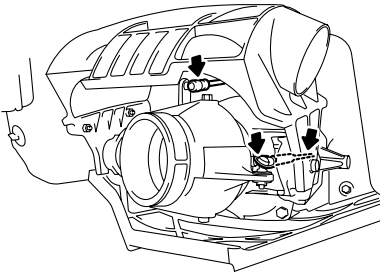

- Shift cable (shift lever end)

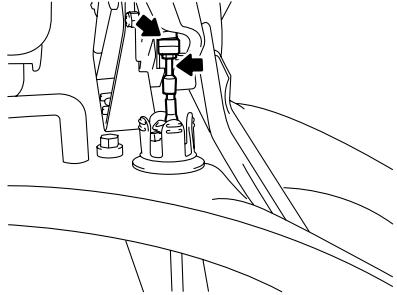

- Shift cable (reverse gate end)

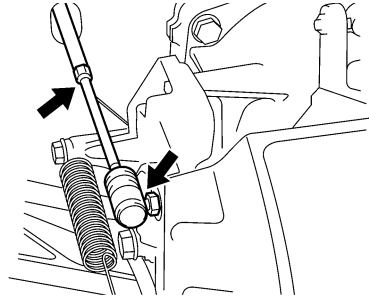

- Intermediate housing

Fill the intermediate housing with water-resistant grease through the grease nipple using a grease gun.

# Maintenance and care

## Grease quantity:

Initial 10 hours or 1 month:

33.0–35.0 cm<sup>3</sup> (1.12–1.18 US oz,  
1.16–1.23 Imp.oz)

Every 100 hours or 12 months:

6.0–8.0 cm<sup>3</sup> (0.20–0.27 US oz,  
0.21–0.28 Imp.oz)

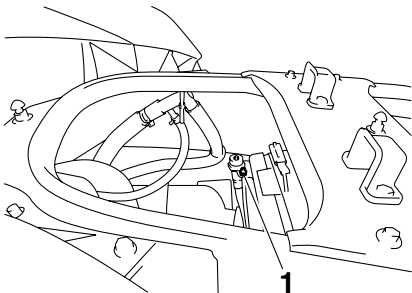

1 Grease nipple

EJU34452

## Checking the battery

Check the level of the battery electrolyte and make sure that the negative (–) and positive (+) battery leads are tightened securely.

EWJ00791

## **WARNING**

**Battery electrolyte is poisonous and dangerous, causing severe burns, etc. Electrolyte contains sulfuric acid. Avoid contact with skin, eyes, or clothing.**

### Antidotes

**External:** Flush with water.

**Internal:** Drink large quantities of water or milk. Follow with milk of magnesia, beaten egg, or vegetable oil. Call a physician immediately.

**Eyes:** Flush with water for 15 minutes and get prompt medical attention.

**Batteries produce explosive gases. Keep sparks, flames, cigarettes, etc., well away. If using or charging the battery in an enclosed space, make sure that it is well ven-**

**tilated. Always shield your eyes when working near batteries.**

**Keep out of the reach of children.**

## To remove the battery:

Disconnect the negative (–) battery lead first, then the positive (+) battery lead and breather hose, and then remove the battery from the watercraft.

## To replenish the battery:

- (1) Make sure that the electrolyte level is between the maximum and minimum level marks.

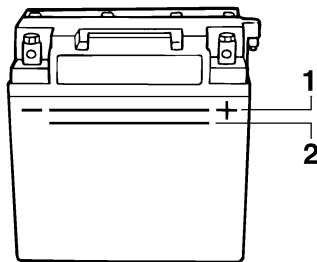

1 Maximum level mark

2 Minimum level mark

- (2) If the electrolyte level is low, add distilled water to raise it to the specified level.

**NOTICE: Use only distilled water for replenishing the battery, otherwise battery life could be shortened.** [EGJ00241]

## To recharge the battery:

EGJ00250

## **NOTICE**

**Do not attempt to charge a battery hastily. Battery life could be shortened.**

It is recommended to have a Yamaha dealer charge the battery. If you charge the battery yourself, be sure to read and follow the instructions provided with the battery tester and charger you use.



## To install the battery:

- (1) Place the battery in the battery compartment. Connect the red lead to the positive (+) battery terminal, and then connect the black lead to the negative (-) battery terminal. **NOTICE: Reversal of the battery leads will damage the electrical parts.**

[ECJ00261]

- (2) Connect the breather hose to the battery.
- (3) Secure the battery in place. **WARNING! Fire or explosion could result if the breather hose is damaged, obstructed, or not connected properly.** [EJV00451]

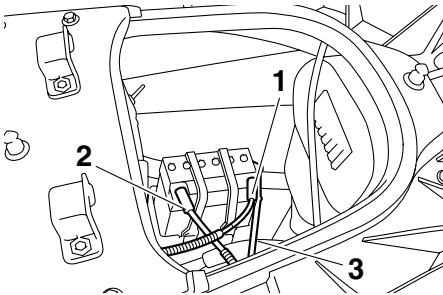

- 1 Positive (+) battery terminal: Red lead
- 2 Negative (-) battery terminal: Black lead
- 3 Breather hose

EJU34491

## **Fuel injection system**

If the fuel injection system is malfunctioning, have a Yamaha dealer service the watercraft.

EJU34500

## **Checking the trolling speed**

- (1) Place the watercraft in the water.
- (2) Start the engine and warm it up. Use the tachometer in the multifunction information center to check the trolling speed.

Trolling speed: 1250 ±100 r/min
------------------------------------

If the trolling speed is out of specification, have a Yamaha dealer service the watercraft.

# Specifications

---

EJU34542

## Specifications

### Watercraft capacity:

Maximum people on board:

3 person

Maximum load capacity:

240 kg (530 lb)

### Dimensions:

Length:

3370 mm (132.7 in)

Width:

1230 mm (48.4 in)

Height:

FX SHO 1160 mm (45.7 in)

FX Cruiser SHO 1240 mm (48.8 in)

Dry weight:

FX SHO 376 kg (829 lb)

FX Cruiser SHO 381 kg (840 lb)

### Performance:

Maximum output (according to ISO 8665/SAE

J1228):

154.50 kW@7500 r/min

Maximum fuel consumption:

63.7 L/h (16.8 US gal/h, 14.0 Imp.gal/h)

Cruising range at full throttle:

1.10 hour

Trolling speed:

1250 ±100 r/min

### Engine:

Engine type:

Liquid cooled 4-stroke, DOHC

Number of cylinders:

4

Engine displacement:

1812 cm<sup>3</sup>

Bore & stroke:

86.0 × 78.0 mm (3.39 × 3.07 in)

Compression ratio:

8.6 : 1

Valve clearance-intake (cold):

0.14–0.23 mm (0.0055–0.0091 in)

Valve clearance-exhaust (cold):

0.28–0.37 mm (0.0110–0.0146 in)

Lubrication system:

Wet sump

Cooling system:

Water

Starting system:

Electric

Ignition system:

T.C.I.

Spark plug:

LFR6A

Spark plug gap:

0.8–0.9 mm (0.031–0.035 in)

Battery capacity:

12 V, 19.0 Ah

Charging system:

Flywheel magneto

### Drive unit:

Propulsion system:

Jet pump

Jet pump type:

Axial flow, single stage

Impeller rotation:

Counterclockwise

Jet thrust nozzle angle:

24.0+24.0 °

Jet thrust nozzle trim angle:

-10, -5, 0, 5, 10 °

### Fuel and oil:

Recommended fuel:

Regular unleaded gasoline

Minimum octane rating (PON):

86

Minimum octane rating (RON):

90

Recommended engine oil type SAE:

SAE 10W-30, 10W-40, 20W-40, 20W-50

Recommended engine oil grade API:

API SE,SF,SG,SH,SJ,SL

Fuel tank total capacity:

70 L (18.5 US gal, 15.4 Imp.gal)

Engine oil quantity with oil filter replacement:

3.1 L (3.28 US qt, 2.73 Imp.qt)

Engine oil quantity without oil filter replacement:

3.0 L (3.17 US qt, 2.64 Imp.qt)

Engine oil total quantity:

4.3 L (4.55 US qt, 3.78 Imp.qt)

EJU34560

## Troubleshooting

If you have any trouble with your watercraft, use this section to check for the possible cause. If you cannot find the cause, or if the procedure for replacement or repair is not described in this owner's/operator's manual, have a Yamaha dealer perform the necessary service.

EJU36982

### Troubleshooting chart

TROUBLE	POSSIBLE CAUSE		REMEDY	PAGE
<b>Engine does not start (Starter motor does not turn over)</b>	Yamaha Security System	Lock mode selected	Select unlock mode	35
	Engine shut-off switch	Clip not in place	Install clip	27
	Fuse	Burned out	Replace fuse and check wiring	96
	Battery	Run down	Recharge	89
		Poor terminal connections	Tighten as required	89
		Terminal corroded	Clean	79
	Starter motor	Faulty	Have serviced by Yamaha dealer	—
<b>Engine does not start (Starter motor turns over)</b>	Throttle lever	Squeezed	Release	28
	Fuel	Empty	Refill as soon as possible	52
		Stale or contaminated	Have serviced by Yamaha dealer	83
	Fuel tank	Water or dirt present	Have serviced by Yamaha dealer	83
	Spark plug	Fouled or defective	Clean or replace	86
	Spark plug cap	Not connected or loose	Connect properly	86
		Connected to wrong cylinder	Connect properly	86
Fuel injection system	Fuel pump faulty	Have serviced by Yamaha dealer	—	

# Trouble recovery

TROUBLE	POSSIBLE CAUSE		REMEDY	PAGE
<b>Engine runs irregularly or stalls</b>	Fuel	Empty	Refill as soon as possible	52
		Stale or contaminated	Have serviced by Yamaha dealer	83
	Fuel tank	Water or dirt present	Have serviced by Yamaha dealer	83
	Spark plug	Fouled or defective	Replace	86
		Incorrect heat range	Replace	86
		Gap incorrect	Adjust	86
	Spark plug cap	Loose	Connect properly	86
		Cracked, torn, or damaged	Have serviced by Yamaha dealer	—
	Electrical wiring	Loose connection	Have serviced by Yamaha dealer	—
Fuel injection system	Faulty or clogged injectors	Have serviced by Yamaha dealer	—	
<b>Warning light or indicator blinks</b>	Fuel level	Empty	Refill as soon as possible	52
	Oil pressure warning	Oil pressure dropped	Have serviced by Yamaha dealer	44
	Engine overheated	Jet intake clogged	Clean	95
	Check engine warning	Faulty sensors	Have serviced by Yamaha dealer	45

# Trouble recovery

TROUBLE	POSSIBLE CAUSE		REMEDY	PAGE
<b>Watercraft slow or loses power</b>	Shift lever	Not completely shifted into forward position	Push lever forward until it stops	31
	Yamaha Security System	Low-RPM mode selected	Select normal mode	36
	Cavitation	Jet intake clogged	Clean	95
		Impeller damaged or worn	Have serviced by Yamaha dealer	95
	Engine over-heat warning	Engine speed reduction control activated	Clean jet intake and cool engine	45
	Oil pressure warning	Engine speed reduction control activated	Add oil	44
	Spark plug	Fouled or defective	Replace	86
		Incorrect heat range	Replace	86
		Gap incorrect	Adjust	86
	Spark plug cap	Loose	Connect properly	86
	Electrical wiring	Loose connection	Have serviced by Yamaha dealer	—
	Fuel	Stale or contaminated	Have serviced by Yamaha dealer	83
	Air filter	Clogged	Have serviced by Yamaha dealer	83
		Oil buildup	Have serviced by Yamaha dealer	83

# Trouble recovery

EJU34620

## Emergency procedures

EJU34631

### Cleaning the jet intake and impeller

EWJ00780

#### **WARNING**

Before attempting to remove weeds or debris from the jet intake or impeller area, shut the engine off and remove the clip from the engine shut-off switch. Severe injury or death could result from coming in contact with the rotating parts of the jet pump.

If weeds or debris gets caught in the jet intake or impeller, cavitation can occur, causing jet thrust to decrease even though engine speed rises. If this condition is allowed to continue, the engine will overheat and may seize. **NOTICE:** If weeds or debris gets caught in the jet intake, do not operate the watercraft above trolling speed until they have been removed. [ECJ00651]

If there is any sign that the jet intake or impeller is clogged with weeds or debris, return to shore and check the intake and impeller. Al-

ways stop the engine before beaching the watercraft.

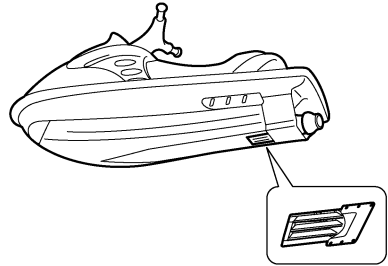
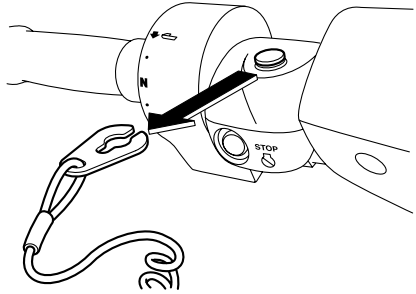

- (1) Place a suitable clean cloth or carpeting underneath the watercraft to protect it from abrasions and scratches. Turn the watercraft on its side as shown. **NOTICE:** Always turn the watercraft over onto its port (left) side. When turning the watercraft on its side, support the bow so that the handlebars are not bent or damaged. [ECJ00661]

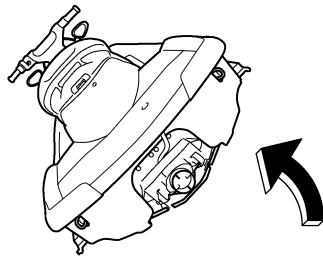

# Trouble recovery

- (2) Remove any weeds or debris from around the jet intake, drive shaft, impeller, jet pump housing, and jet thrust nozzle.

If debris is difficult to remove, consult a Yamaha dealer.

EJU34641

## Jumping the battery

If the watercraft battery has run down, the engine can be started using a 12-volt booster battery and jumper cables.

EJU34662

## Connecting the jumper cables

EWJ01250



### WARNING

**To avoid battery explosion and serious damage to the electrical system:**

- Do not reverse the polarity of the jumper cables when connecting to the batteries.
- Do not connect the negative (-) jumper cable to the negative (-) terminal of the watercraft battery.
- Do not touch the positive (+) jumper cable to the negative (-) jumper cable.

- (1) Connect the positive (+) jumper cable to the positive (+) battery terminals of both batteries.
- (2) Connect one end of the negative (-) jumper cable to the negative (-) battery terminal of the booster battery.

- (3) Connect the other end of the negative (-) jumper cable to an engine hanger.

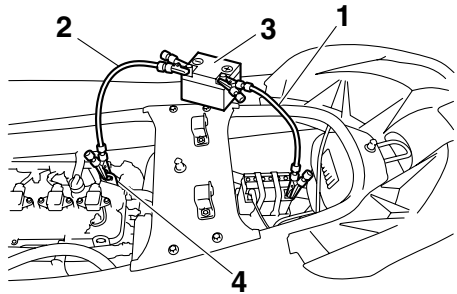

- 1 Positive (+) jumper cable
- 2 Negative (-) jumper cable
- 3 Booster battery
- 4 Engine hanger

- (4) Start the engine, and then disconnect the jumper cables by reversing the steps above. **NOTICE: Never push the start switch while the engine is running. Do not operate the start switch for more than 5 seconds, otherwise the battery will be discharged and the engine will not start. Also, the starter motor could be damaged. If the engine does not start in 5 seconds, release the start switch, wait 15 seconds, and then try again.** [ECJ00481]

EJU36991

## Replacing the fuses

The fuses are located in the electrical box.

To replace a fuse:

- (1) Remove the seats. (See page 25 for seat removal and installation procedures.)

# Trouble recovery

- (2) Remove the electrical box cover.

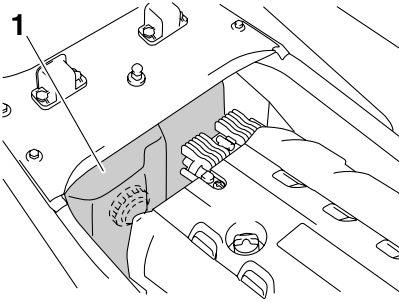

1 Electrical box cover

- (3) Remove the cap on the electrical box.  
(4) Replace the blown fuse with the spare fuse of the correct amperage by using the fuse puller on the reverse side of the cap.

**WARNING! Do not use fuses of higher amperage than recommended. Substitution with a fuse that has an improper rating can cause extensive electrical**

**system damage and possible fire.**

[EWJ00801]

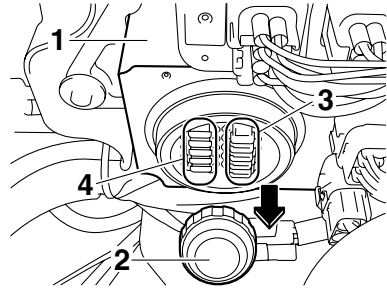

- 1 Electrical box  
2 Cap  
3 Fuse  
4 Spare fuse

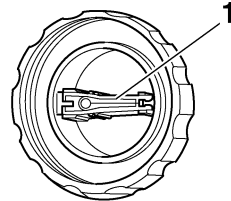

1 Fuse puller

Fuse amperage:  
Battery fuse:  
30 A  
Main relay drive fuse:  
10 A  
Electronic throttle valve fuse:  
10 A  
Security system fuse:  
3 A  
Main fuse:  
20 A

- (5) Install the cap.  
(6) Install the electrical box cover.  
(7) Install the seats.



EJU34711

## Towing the watercraft

EWJ00811



- The operator of the towing boat must keep speed to a minimum and avoid traffic or obstacles which could be a hazard to the operator on the watercraft.
- The towline should be long enough so that the watercraft will not collide with the towing boat when slowing down.

If the watercraft becomes inoperative in the water, it can be towed to shore.

When the watercraft is towed using a towline, the operator should hold onto the handlebars and ride the watercraft in order to balance it. Use a towline that is three times the combined length of the towing boat and the watercraft.

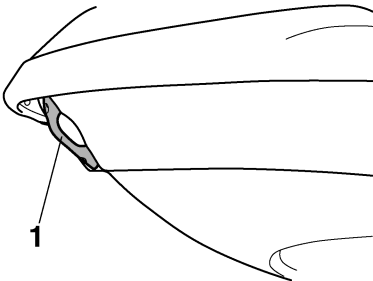

1 Bow eye

Tow the watercraft at 5 mph (8 km/h) or less. The bow must be kept up out of the water during towing to prevent water from entering the engine compartment.

EJU36151

## Submerged watercraft

If the watercraft is submerged or flooded with water, follow the procedure below and consult a Yamaha dealer as soon as possible. Failure to do so could result in serious engine damage.

- (1) Beach the watercraft and remove the stern drain plugs to drain the water from

the engine compartment. (See page 58 for more information.)

Remove the storage compartment drain plugs to drain the water from the storage compartments.

- (2) Install the stern drain plugs and storage compartment drain plugs.
- (3) Have the watercraft inspected by a Yamaha dealer as soon as possible.

**NOTICE: Be sure to have a Yamaha dealer inspect the watercraft. Otherwise, serious engine damage could result.** [ECJ00791]

# Index

---

<b>A</b>		<b>F</b>	
Air filter element .....	83	Fire extinguisher.....	59
Analog speedometer/tachometer .....	40	Flushing the cooling system.....	78
Analog speedometer/tachometer and indicator lights.....	40	Front storage compartment.....	49
<b>B</b>		Fuel .....	52
Battery.....	58, 79	Fuel and oil.....	52
Battery, checking.....	89	Fuel injection system.....	90
Battery, jumping .....	96	Fuel level.....	56
Beaching the watercraft .....	75	Fuel level meter.....	43
Beverage holder.....	51	Fuel level warning indicator.....	44
Bilge .....	58	Fuel system, checking.....	83
Boarding alone .....	70	Fuel tank .....	83
Boarding and starting from a dock .....	69	Fuel tank filler cap .....	26
Boarding and starting in deep water .....	69	Fuses, replacing.....	96
Boarding and starting in shallow water ....	69	<b>G</b>	
Boarding with passengers.....	70	Getting to know your watercraft .....	67
Bow down.....	32	Glove compartment.....	50
Bow eye .....	33	<b>H</b>	
Bow up .....	32	Handgrip.....	33
Builder's plate.....	2	Hazard information.....	15
<b>C</b>		Hood.....	26
Capsized watercraft .....	72	Hour meter/voltmeter .....	44
Check engine warning indicator .....	45	Hull and deck .....	56
Cleaning the watercraft .....	79	<b>I</b>	
Cooling water pilot outlets .....	29, 63	Identification numbers .....	1
Craft Identification Number (CIN).....	1	<b>J</b>	
Cruise assist.....	37	Jet intake .....	62
Cruising limitations .....	11	Jet intake and impeller, cleaning.....	95
<b>D</b>		Jet thrust nozzle angle, checking .....	83
Digital speedometer .....	43	Jumper cables, connecting .....	96
Docking the watercraft .....	75	<b>L</b>	
<b>E</b>		Labels, important.....	3
Emergency procedures .....	95	Labels, other .....	8
Engine break-in .....	64	Labels, warning .....	4
Engine compartment .....	56	Launching the watercraft.....	64
Engine oil .....	53	Learning to operate your watercraft .....	67
Engine oil and oil filter.....	83	Leaving the watercraft.....	66
Engine oil level.....	56	Left multifunction display and operation buttons .....	42
Engine overheat warning indicator.....	45	Limitations on who may operate the watercraft .....	10
Engine serial number .....	1	"L-MODE" indicator light.....	42
Engine shut-off cord (lanyard).....	62	Lubrication.....	79
Engine shut-off switch.....	27	Lubrication points .....	87
Engine stop switch .....	27		
Enjoy your watercraft responsibly .....	19		

<b>M</b>	
Main components, location of .....	21
Maintenance and adjustments .....	80
Model information.....	2
Multifunction information center .....	39, 63
<b>N</b>	
No-wake mode .....	36
“NO-WAKE MODE” switch.....	29
<b>O</b>	
Oil pressure warning indicator.....	44
Operating in weeded areas .....	76
Operating your watercraft.....	67
Operation .....	64
Operation of controls and other functions .....	25
Operation requirements .....	12
Owner’s/operator’s manual and tool kit....	80
<b>P</b>	
Periodic maintenance chart.....	81
Post-operation care.....	76
Pre-operation check list.....	54
Pre-operation check points .....	56
Pre-operation checks .....	54
Primary Identification (PRI-ID) number .....	1
Pull-up cleats (for FX Cruiser SHO) .....	34
<b>Q</b>	
Quick Shift Trim System (QSTS) .....	61
Quick Shift Trim System (QSTS) selector .....	31
<b>R</b>	
Reboarding step.....	33
Recommended equipment.....	14
Remote control transmitter.....	26
Reverse on waterways.....	75
Riding with passengers .....	68
Right multifunction display and operation buttons (for FX Cruiser SHO) .....	46
“RPM” indicator light.....	41
<b>S</b>	
Safe boating rules .....	19
Seat storage compartment.....	50
Seats .....	25
Selecting the operation mode .....	36
“SET” switch.....	29
Shift cable, checking .....	84
Shift lever .....	31
Shift lever and reverse gate .....	60
Shifting .....	66
Spark plugs, cleaning and adjusting .....	86
“SPEED” indicator light .....	41
Start switch.....	28
Starting the engine .....	64
Starting the watercraft .....	68
Steering system .....	30, 60
Stern drain plugs .....	58
Stern eyes .....	34
Stopping the engine .....	65
Stopping the watercraft .....	74
Storage.....	78
Storage compartments .....	49
Submerged watercraft .....	98
Switches .....	62
Switches, right handlebar .....	28
<b>T</b>	
Throttle cable, checking and adjusting ....	84
Throttle lever .....	29, 59
Tilt lever.....	30
Towing the watercraft.....	98
Transporting .....	77
Trolling speed, checking .....	90
Troubleshooting .....	92
Troubleshooting chart .....	92
Turning the watercraft .....	73
<b>U</b>	
“UNLOCK” indicator light.....	42
Up and down switches .....	29
<b>W</b>	
“WARNING” indicator light .....	42
Water separator .....	57
Watercraft characteristics.....	15
Water-skiing .....	17
Watertight compartment.....	51
<b>Y</b>	
Yamaha Engine Management System (YEMS) .....	34
Yamaha Security System.....	34
Yamaha Security System settings .....	35



Printed in U.S.A.  
August 2008-0.3 x 1 CR