



**F200C**  
**FL200C**  
**F225B**  
**FL225B**  
**F225C**  
**F250A**  
**FL250A**

## **OWNER'S MANUAL**

**▲ Read this manual carefully before operating this outboard motor.**

**6P2-28199-78-E0**

**Read this manual carefully before operating this outboard motor. Keep this manual onboard in a waterproof bag when boating. This manual should stay with the outboard motor if it is sold.**

# Important manual information

---

EMU25107

## To the owner

Thank you for selecting a Yamaha outboard motor. This Owner's Manual contains information needed for proper operation, maintenance and care. A thorough understanding of these simple instructions will help you obtain maximum enjoyment from your new Yamaha. If you have any question about the operation or maintenance of your outboard motor, please consult a Yamaha dealer.

In this Owner's Manual particularly important information is distinguished in the following ways.



: This is the safety alert symbol. It is used to alert you to potential personal injury hazards. Obey all safety messages that follow this symbol to avoid possible injury or death.

EWMO0781



### **WARNING**

**A WARNING indicates a hazardous situation which, if not avoided, could result in death or serious injury.**

---

ECMO0701

### **NOTICE**

**A NOTICE indicates special precautions that must be taken to avoid damage to the outboard motor or other property.**

---

### **TIP:**

A TIP provides key information to make procedures easier or clearer.

Yamaha continually seeks advancements in product design and quality. Therefore, while this manual contains the most current product information available at the time of printing, there may be minor discrepancies between

your machine and this manual. If there is any question concerning this manual, please consult your Yamaha dealer.

To ensure long product life, Yamaha recommends that you use the product and perform the specified periodic inspections and maintenance by correctly following the instructions in the owner's manual. Any damage resulting from neglect of these instructions is not covered by warranty.

Some countries have laws or regulations restricting users from taking the product out of the country where it was purchased, and it may be impossible to register the product in the destination country. Additionally, the warranty may not apply in certain regions. When planning to take the product to another country, consult the dealer where the product was purchased for further information.

If the product was purchased used, please consult your closest dealer for customer re-registration, and to be eligible for the specified services.

### **TIP:**

The F200CET, FL200CET, F225BET, FL225BET, F225CET, F250AET, FL250AET and the standard accessories are used as a base for the explanations and illustrations in this manual. Therefore some items may not apply to every model.

# Important manual information

---

EMU25121

**F200C, FL200C, F225B, FL225B, F225C,  
F250A, FL250A**

**OWNER'S MANUAL**

**©2011 by Yamaha Motor Co., Ltd.**

**1st Edition, March 2011**

**All rights reserved.**

**Any reprinting or unauthorized use  
without the written permission of**

**Yamaha Motor Co., Ltd.**

**is expressly prohibited.**

**Printed in Japan**

# Table of contents

<b>Safety information</b> .....	1	Propeller selection .....	12
Outboard motor safety .....	1	Counter rotation models .....	12
Propeller .....	1	Start-in-gear protection .....	13
Rotating parts .....	1	Engine oil requirements .....	13
Hot parts .....	1	Fuel requirements .....	13
Electric shock .....	1	Gasoline .....	13
Power trim and tilt.....	1	Muddy or acidic water .....	14
Engine shut-off cord (lanyard) .....	1	Anti-fouling paint .....	14
Gasoline .....	1	Motor disposal requirements.....	14
Gasoline exposure and spills .....	1	Emergency equipment .....	14
Carbon monoxide .....	2	<b>Components</b> .....	<b>16</b>
Modifications .....	2	Components diagram.....	16
Boating safety .....	2	Remote control box .....	17
Alcohol and drugs.....	2	Remote control lever .....	18
Personal flotation devices .....	2	Free accelerator .....	18
People in the water.....	2	Throttle friction adjuster .....	19
Passengers .....	2	Engine shut-off cord (lanyard) and clip.....	19
Overloading .....	2	Main switch.....	20
Avoid collisions.....	2	Power trim and tilt switch on remote control .....	20
Weather.....	3	Power trim and tilt switch on bottom cowling .....	20
Passenger training .....	3	Power trim and tilt switches (twin binnacle type) .....	21
Boating safety publications.....	3	Trim tab with anode .....	21
Laws and regulations .....	3	Tilt support lever for power trim and tilt model.....	22
<b>General information</b> .....	<b>4</b>	Cowling lock lever (pull up type).....	22
Identification numbers record .....	4	Flushing device .....	23
Outboard motor serial number .....	4	Fuel filter/Water separator .....	23
Key number .....	4	<b>Instruments and indicators</b> .....	<b>25</b>
EC Declaration of Conformity (DoC).....	4	Digital tachometer .....	25
CE Marking .....	4	Tachometer .....	25
Read manuals and labels.....	6	Trim meter .....	25
Warning labels.....	6	Hour meter .....	25
<b>Specifications and requirements</b> .....	<b>9</b>	Low oil pressure-alert indicator .....	26
Specifications .....	9	Overheat-alert indicator .....	26
Installation requirements .....	11	Digital speedometer .....	26
Boat horsepower rating .....	11	Speedometer .....	26
Mounting motor .....	11	Fuel gauge .....	27
Remote control requirements .....	11	Trip meter / Clock / Voltmeter.....	27
Battery requirements .....	12	Fuel level-alert indicator .....	28
Battery specifications .....	12	Low battery voltage-alert indicator ...	28
Mounting battery.....	12		
Multiple batteries .....	12		

# Table of contents

---

Fuel management meter .....	28	Battery .....	46
Fuel flow meter .....	28	Filling fuel .....	46
Fuel consumption meter / Fuel economy meter / Twin engine speed synchronizer .....	29	Operating engine .....	47
Water separator-alert indicator .....	31	Sending fuel .....	47
6Y8 Multifunction meters .....	31	Starting engine .....	47
6Y8 Multifunction tachometers .....	31	Checks after starting engine .....	49
Start-up checks .....	32	Cooling water .....	49
Low oil pressure-alert .....	32	Warming up engine .....	49
Overheat alert .....	33	Electric start models .....	49
Water separator alert .....	33	Checks after engine warm up .....	50
Engine trouble alert .....	33	Shifting .....	50
Low battery voltage-alert .....	34	Stop switches .....	50
6Y8 Multifunction speed & fuel meters .....	34	Shifting .....	50
6Y8 Multifunction speedometers ...	35	Stopping boat .....	51
6Y8 Multifunction fuel management meters .....	36	Stopping engine .....	51
<b>Engine control system .....</b>	<b>37</b>	Procedure .....	51
Alert system .....	37	Trimming outboard motor .....	51
Overheat alert .....	37	Adjusting trim angle (Power trim and tilt) .....	52
Low oil pressure alert .....	37	Adjusting boat trim .....	53
<b>Installation .....</b>	<b>39</b>	Tilting up and down .....	53
Installation .....	39	Procedure for tilting up (power trim and tilt models) .....	54
Mounting the outboard motor .....	39	Procedure for tilting down (power trim and tilt models) .....	55
<b>Operation .....</b>	<b>41</b>	Shallow water .....	56
First-time operation .....	41	Power trim and tilt models .....	56
Fill engine oil .....	41	Cruising in other conditions .....	57
Breaking in engine .....	41	<b>Maintenance .....</b>	<b>58</b>
Getting to know your boat .....	41	Transporting and storing outboard motor .....	58
Checks before starting engine .....	41	Storing outboard motor .....	58
Fuel level .....	41	Procedure .....	59
Remove cowling .....	42	Lubrication .....	60
Fuel system .....	42	Flushing power unit .....	60
Controls .....	42	Cleaning the outboard motor .....	61
Engine shut-off cord (lanyard) .....	43	Checking painted surface of outboard motor .....	62
Engine oil .....	43	Periodic maintenance .....	62
Engine .....	43	Replacement parts .....	62
Flushing device .....	43	Severe operating conditions .....	62
Install cowling .....	44	Maintenance chart 1 .....	63
Checking power trim and tilt system .....	45	Maintenance chart 2 .....	65

# Table of contents

---

Greasing .....	66
Cleaning and adjusting spark plug ...	68
Inspecting idle speed.....	69
Changing engine oil.....	69
Inspecting wiring and connectors .....	71
Checking propeller .....	71
Removing propeller .....	72
Installing propeller .....	73
Changing gear oil .....	74
Inspecting and replacing anode(s) ...	77
Checking battery (for electric start models) .....	77
Connecting the battery .....	78
Disconnecting the battery.....	79
<b>Trouble Recovery .....</b>	<b>81</b>
Troubleshooting .....	81
Temporary action in emergency....	84
Impact damage.....	84
Running single engine (twin engines).....	84
Replacing fuse.....	85
Power trim and tilt will not operate ...	86
Water separator-alert indicator blinks while cruising .....	86
Treatment of submerged motor.....	88

# Safety information

---

EMU33622

## Outboard motor safety

Observe these precautions at all times.

EMU36501

### Propeller

People can be injured or killed if they come in contact with the propeller. The propeller can keep moving even when the motor is in neutral, and sharp edges of the propeller can cut even when stationary.

- Stop the engine when a person is in the water near you.
- Keep people out of reach of the propeller, even when the engine is off.

EMU33630

### Rotating parts

Hands, feet, hair, jewelry, clothing, PFD straps, etc. can become entangled with internal rotating parts of the engine, resulting in serious injury or death.

Keep the top cowling in place whenever possible. Do not remove or replace the cowling with the engine running.

Only operate the engine with the cowling removed according to the specific instructions in the manual. Keep hands, feet, hair, jewelry, clothing, PFD straps, etc. away from any exposed moving parts.

EMU33640

### Hot parts

During and after operation, engine parts are hot enough to cause burns. Avoid touching any parts under the top cowling until the engine has cooled.

EMU33650

### Electric shock

Do not touch any electrical parts while starting or operating the engine. They can cause shock or electrocution.

EMU33660

### Power trim and tilt

Body parts can be crushed between the motor and the clamp bracket when the motor is trimmed or tilted. Keep body parts out of this

area at all times. Be sure no one is in this area before operating the power trim and tilt mechanism.

The power trim and tilt switches operate even when the main switch is off. Keep people away from the switches whenever working around the motor.

Never get under the lower unit while it is tilted, even when the tilt support lever is locked. Severe injury could occur if the outboard motor accidentally falls.

EMU33671

### Engine shut-off cord (lanyard)

Attach the engine shut-off cord so that the engine stops if the operator falls overboard or leaves the helm. This prevents the boat from running away under power and leaving people stranded, or running over people or objects.

Always attach the engine shut-off cord to a secure place on your clothing or your arm or leg while operating. Do not remove it to leave the helm while the boat is moving. Do not attach the cord to clothing that could tear loose, or route the cord where it could become entangled, preventing it from functioning.

Do not route the cord where it is likely to be accidentally pulled out. If the cord is pulled during operation, the engine will shut off and you will lose most steering control. The boat could slow rapidly, throwing people and objects forward.

EMU33810

### Gasoline

**Gasoline and its vapors are highly flammable and explosive.** Always, refuel according to the procedure on page 47 to reduce the risk of fire and explosion.

EMU33820

### Gasoline exposure and spills

Take care not to spill gasoline. If gasoline spills, wipe it up immediately with dry rags. Dispose of rags properly.



If any gasoline spills onto your skin, immediately wash with soap and water. Change clothing if gasoline spills on it.

If you swallow gasoline, inhale a lot of gasoline vapor, or get gasoline in your eyes, get immediate medical attention. Never siphon fuel by mouth.

EMU33900

### **Carbon monoxide**

This product emits exhaust gases which contain carbon monoxide, a colorless, odorless gas which may cause brain damage or death when inhaled. Symptoms include nausea, dizziness, and drowsiness. Keep cockpit and cabin areas well ventilated. Avoid blocking exhaust outlets.

EMU33780

### **Modifications**

Do not attempt to modify this outboard motor. Modifications to your outboard motor may reduce safety and reliability, and render the outboard unsafe or illegal to use.

EMU33740

## **Boating safety**

This section includes a few of the many important safety precautions that you should follow when boating.

EMU33710

### **Alcohol and drugs**

Never operate after drinking alcohol or taking drugs. Intoxication is one of the most common factors contributing to boating fatalities.

EMU33720

### **Personal flotation devices**

Have an approved personal flotation device (PFD) on board for every occupant. Yamaha recommends that you must wear a PFD whenever boating. At a minimum, children and non-swimmers should always wear PFDs, and everyone should wear PFDs when there are potentially hazardous boating conditions.

EMU33731

### **People in the water**

Always watch carefully for people in the water, such as swimmers, skiers, or divers, whenever the engine is running. When someone is in the water near the boat, shift into neutral and stop the engine.

Stay away from swimming areas. Swimmers can be hard to see.

The propeller can keep moving even when the motor is in neutral. Stop the engine when a person is in the water near you.

EMU33751

### **Passengers**

Consult your boat manufacturer's instructions for details about appropriate passenger locations in your boat and be sure all passengers are positioned properly before accelerating and when operating above an idle speed. Standing or sitting in non-designated locations may result in being thrown either overboard or within the boat due to waves, wakes, or sudden changes in speed or direction. Even when people are positioned properly, alert your passengers if you must make any unusual maneuver. Always avoid jumping waves or wakes.

EMU33760

### **Overloading**

Do not overload the boat. Consult the boat capacity plate or boat manufacturer for maximum weight and number of passengers. Be sure that weight is properly distributed according to the boat manufacturer's instructions. Overloading or incorrect weight distribution can compromise the boat's handling and lead to an accident, capsizing or swamping.

EMU33772

### **Avoid collisions**

Scan constantly for people, objects, and other boats. Be alert for conditions that limit your visibility or block your vision of others.

# Safety information

---

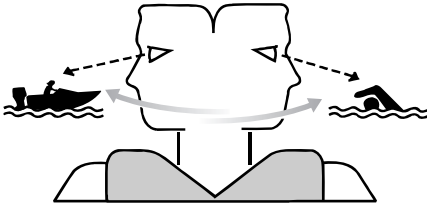

ZMU06025

Operate defensively at safe speeds and keep a safe distance away from people, objects, and other boats.

- Do not follow directly behind other boats or waterskiers.
- Avoid sharp turns or other maneuvers that make it hard for others to avoid you or understand where you are going.
- Avoid areas with submerged objects or shallow water.
- Ride within your limits and avoid aggressive maneuvers to reduce the risk of loss of control, ejection, and collision.
- Take early action to avoid collisions. Remember, boats do not have brakes, and stopping the engine or reducing throttle can reduce the ability to steer. If you are not sure that you can stop in time before hitting an obstacle, apply throttle and turn in another direction.

EMU33790

## **Weather**

Stay informed about the weather. Check weather forecasts before boating. Avoid boating in hazardous weather.

EMU33880

## **Passenger training**

Make sure at least one other passenger is trained to operate the boat in the event of an emergency.

EMU33890

## **Boating safety publications**

Be informed about boating safety. Additional publications and information can be obtained from many boating organizations.

EMU33600

## **Laws and regulations**

Know the marine laws and regulations where you will be boating- and obey them. Several sets of rules prevail according to geographic location, but all are basically the same as the International Rules of the Road.

EMU25171

## Identification numbers record

EMU25184

### Outboard motor serial number

The outboard motor serial number is stamped on the label attached to the port side of the clamp bracket.

Record your outboard motor serial number in the spaces provided to assist you in ordering spare parts from your Yamaha dealer or for reference in case your outboard motor is stolen.

--	--	--	--

ZMU01693

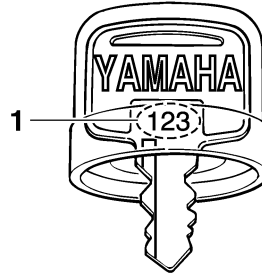

ZMU01694

1. Key number

EMU37291

## EC Declaration of Conformity (DoC)

This outboard motor conforms to certain portions of the European Parliament directive relating to machinery.

Each conformed outboard motor accompanied with EC DoC. EC DoC contains the following information;

- Name of Engine Manufacture
- Model name
- Product code of model (Approved model code)
- Code of conformed directives

EMU25205

## CE Marking

Outboard motors affixed with this “CE” marking conform with the directives of; 98/37/EC, 94/25/EC - 2003/44/EC and 2004/108/EC.

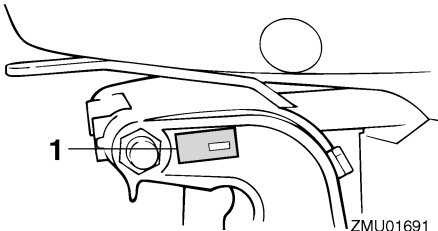

ZMU01691

1. Outboard motor serial number location

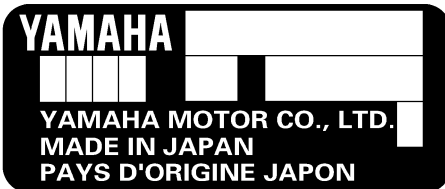

ZMU01692

EMU25191

### Key number

If a main key switch is equipped with the motor, the key identification number is stamped on your key as shown in the illustration. Record this number in the space provided for reference in case you need a new key.

# General information

---

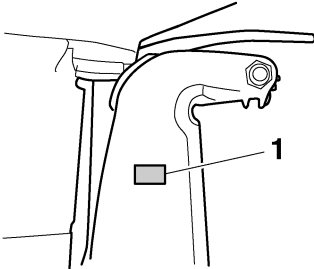

ZMU04259

1. CE marking location



ZMU06040

EMU33523

## Read manuals and labels

Before operating or working on this outboard motor:

- Read this manual.
- Read any manuals supplied with the boat.
- Read all labels on the outboard motor and the boat.

If you need any additional information, contact your Yamaha dealer.

EMU33832

## Warning labels

If these labels are damaged or missing, contact your Yamaha dealer for replacements.

**F200C, FL200C, F225B, FL225B, F225C, F250A, FL250A**

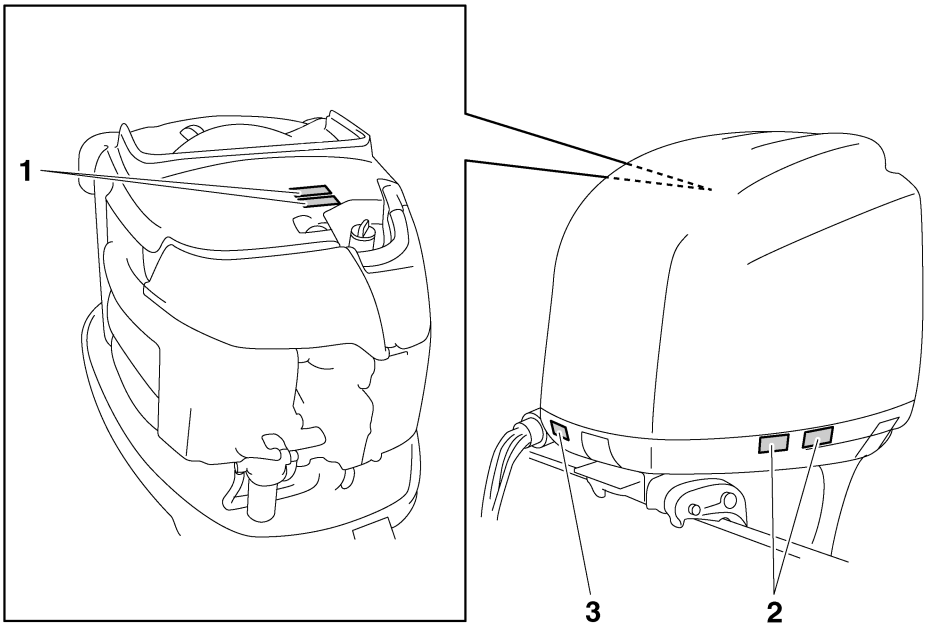

ZMU06242

# General information

1



2

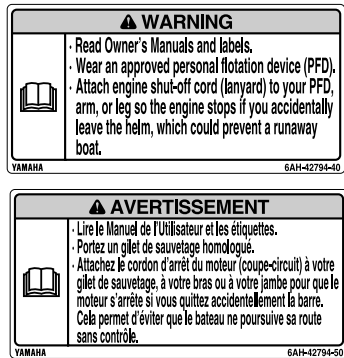

EMU34651

## Contents of labels

The above warning labels mean as follows.

1

EWM01681

- WARNING**
- Keep hands, hair, and clothing away from rotating parts while the engine is running.
  - Do not touch or remove electrical parts when starting or during operation.

2

EWM01671

- WARNING**
- Read Owner's Manuals and labels.
  - Wear an approved personal flotation device (PFD).

ZMU06191

- Attach engine shut-off cord (lanyard) to your PFD, arm, or leg so the engine stops if you accidentally leave the helm, which could prevent a runaway boat.

EMU33850

## Other labels

3



ZMU05710

# General information

EMU33843

## Symbols

The following symbols mean as follows.

Notice/Warning



ZMU05696

Read Owner's Manual



ZMU05664

Hazard caused by continuous rotation

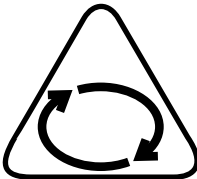

ZMU05665

Electrical hazard

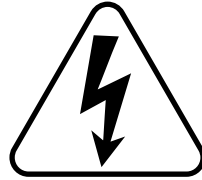

ZMU05666

Remote control lever/gear shift lever operating direction, dual direction



ZMU05667

Engine start/ Engine cranking

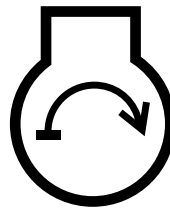

ZMU05668

# Specifications and requirements

---

EMU34521

## Specifications

### TIP:

“(AL)” stated in the specification data below represents the numerical value for the aluminum propeller installed.

Likewise, “(SUS)” represents the value for stainless steel propeller installed and “(PL)” for plastic propeller installed.

EMU2821K

### Dimension:

#### Overall length:

- F200CET 868 mm (34.2 in)
- F225BET 868 mm (34.2 in)
- F225CET 892 mm (35.1 in)
- F250AET 868 mm (34.2 in)
- FL200CET 868 mm (34.2 in)
- FL225BET 868 mm (34.2 in)
- FL250AET 868 mm (34.2 in)

#### Overall width:

- 634 mm (25.0 in)

#### Overall height L:

- F225CET 1705 mm (67.1 in)

#### Overall height X:

- F200CET 1829 mm (72.0 in)
- F225BET 1829 mm (72.0 in)
- F250AET 1829 mm (72.0 in)
- FL200CET 1829 mm (72.0 in)
- FL225BET 1829 mm (72.0 in)
- FL250AET 1829 mm (72.0 in)

#### Overall height U:

- F225BET 1956 mm (77.0 in)
- F250AET 1956 mm (77.0 in)
- FL250AET 1956 mm (77.0 in)

#### Transom height L:

- F225CET 516 mm (20.3 in)

#### Transom height X:

- F200CET 643 mm (25.3 in)
- F225BET 643 mm (25.3 in)
- F250AET 643 mm (25.3 in)
- FL200CET 643 mm (25.3 in)
- FL225BET 643 mm (25.3 in)
- FL250AET 643 mm (25.3 in)

#### Transom height U:

- F225BET 770 mm (30.3 in)
- F250AET 770 mm (30.3 in)
- FL250AET 770 mm (30.3 in)

#### Weight (SUS) L:

- F225CET 273.0 kg (602 lb)

#### Weight (SUS) X:

- F200CET 283.0 kg (624 lb)
- F225BET 278.0 kg (613 lb)
- F250AET 278.0 kg (613 lb)
- FL200CET 283.0 kg (624 lb)
- FL225BET 278.0 kg (613 lb)
- FL250AET 278.0 kg (613 lb)

#### Weight (SUS) U:

- F225BET 284.0 kg (626 lb)
- F250AET 284.0 kg (626 lb)
- FL250AET 284.0 kg (626 lb)

### Performance:

- Full throttle operating range:  
5000–6000 r/min



# Specifications and requirements

## Maximum output:

F200CET 147.1 kW@5500 r/min (200 HP@5500 r/min)  
F225BET 165.5 kW@5500 r/min (225 HP@5500 r/min)  
F225CET 165.5 kW@5500 r/min (225 HP@5500 r/min)  
F250AET 183.9 kW@5500 r/min (250 HP@5500 r/min)  
FL200CET 147.1 kW@5500 r/min (200 HP@5500 r/min)  
FL225BET 165.5 kW@5500 r/min (225 HP@5500 r/min)  
FL250AET 183.9 kW@5500 r/min (250 HP@5500 r/min)

## Idle speed (in neutral):

650 ±50 r/min

## Engine:

### Type:

4-stroke V

### Displacement:

3352.0 cm<sup>3</sup>

### Bore × stroke:

94.0 × 80.5 mm (3.70 × 3.17 in)

### Ignition system:

TCI

### Spark plug (NGK):

LFR6A-11

### Spark plug gap:

1.0–1.1 mm (0.039–0.043 in)

### Control system:

Remote control

### Starting system:

Electric starter

### Starting carburetion system:

Electronic fuel injection

### Valve clearance (cold engine) IN:

0.17–0.24 mm (0.0067–0.0094 in)

### Valve clearance (cold engine) EX:

0.31–0.38 mm (0.0122–0.0150 in)

## Min. cold cranking amps (CCA/EN):

711.0 A

## Min. rated capacity (20HR/IEC):

100 Ah

## Maximum generator output:

44 A

## Drive unit:

### Gear positions:

Forward-neutral-reverse

### Gear ratio:

2.00(30/15)

### Trim and tilt system:

Power trim and tilt

### Propeller mark:

F200CET T / M

F225BET T / M

F225CET T / M

F250AET T / M

FL200CET TL / ML

FL225BET TL / ML

FL250AET TL / ML

## Fuel and oil:

### Recommended fuel:

F200CET Regular unleaded gasoline

F225BET Regular unleaded gasoline

F225CET Premium unleaded gasoline

F250AET Premium unleaded gasoline

FL200CET Regular unleaded gasoline

FL225BET Regular unleaded gasoline

FL250AET Premium unleaded gasoline

### Min. research octane:

F200CET 90

F225BET 90

F225CET 94

F250AET 94

FL200CET 90

FL225BET 90

FL250AET 94

### Recommended engine oil:

4-stroke outboard motor oil

# Specifications and requirements

---

Recommended engine oil grade 1:

SAE 10W-30/10W-40/5W-30

API SE/SF/SG/SH/SJ/SL

Total engine oil quantity (oil pan capacity):

5.6 L (5.92 US qt, 4.93 Imp.qt)

Lubrication:

Wet sump

Recommended gear oil:

Hypoid gear oil SAE#90

Gear oil quantity:

F200CET 1.150 L (1.216 US qt,  
1.012 Imp.qt)

F225BET 1.150 L (1.216 US qt,  
1.012 Imp.qt)

F225CET 0.920 L (0.972 US qt,  
0.810 Imp.qt)

F250AET 0.920 L (0.972 US qt,  
0.810 Imp.qt)

FL200CET 1.000 L (1.057 US qt,  
0.880 Imp.qt)

FL225BET 1.000 L (1.057 US qt,  
0.880 Imp.qt)

FL250AET 0.800 L (0.846 US qt,  
0.704 Imp.qt)

## Tightening torque for engine:

Spark plug:

25.0 Nm (2.55 kgf-m, 18.4 ft-lb)

Propeller nut:

55.0 Nm (5.61 kgf-m, 40.6 ft-lb)

Engine oil drain bolt:

28.0 Nm (2.86 kgf-m, 20.7 ft-lb)

Engine oil filter:

18.0 Nm (1.84 kgf-m, 13.3 ft-lb)

## Noise and vibration level:

Operator sound pressure level (ICOMIA  
39/94 and 40/94):

79.7 dB(A)

EMU33554

## Installation requirements

EMU33564

### Boat horsepower rating

EWM01560



**Overpowering a boat can cause severe instability.**

---

Before installing the outboard motor(s), confirm that the total horsepower of your outboard motor(s) does not exceed the boat's maximum horsepower rating. See the boat's capacity plate or contact the manufacturer.

EMU33571

### Mounting motor

EWM01570



- **Improper mounting of the outboard motor could result in hazardous conditions such as poor handling, loss of control, or fire hazards.**
  - **Because the motor is very heavy, special equipment and training is required to mount it safely.**
- 

Your dealer or other person experienced in proper rigging should mount the motor using correct equipment and complete rigging instructions. For further information, see page 39.

EMU33581

## Remote control requirements

EWM01580



- **If the engine starts in gear, the boat can move suddenly and unexpectedly, possibly causing a collision or throwing passengers overboard.**
  - **If the engine ever starts in gear, the start-in-gear protection device is not working correctly and you should discontinue using the outboard. Contact your Yamaha dealer.**
-

# Specifications and requirements

The remote control unit must be equipped with a start-in-gear protection device(s). This device prevents the engine from starting unless it is in neutral.

EMU25694

## Battery requirements

EMU25721

### Battery specifications

Minimum cold cranking amps (CCA/EN): 711.0 A
Minimum rated capacity (20HR/IEC): 100 Ah

The engine cannot be started if battery voltage is too low.

EMU36290

### Mounting battery

Mount the battery holder securely in a dry, well-ventilated, vibration-free location in the boat. **WARNING! Do not put flammable items, or loose heavy or metal objects in the same compartment as the battery. Fire, explosion or sparks could result.**

[EWM01820]

EMU36300

### Multiple batteries

To connect multiple batteries, such as for multiple engine configurations or for an accessory battery, consult your Yamaha dealer about battery selection and correct wiring.

EMU41600

## Propeller selection

Next to selecting an outboard motor, selecting the right propeller is one of the most important purchasing decisions a boater can make. The type, size, and design of your propeller have a direct impact on acceleration, top speed, fuel economy, and even engine life. Yamaha designs and manufactures propellers for every Yamaha outboard motor and every application.

Your Yamaha dealer can help you select the right propeller for your boating needs. Select a propeller that will allow the engine to reach

the middle or upper half of the operating range at full throttle with the maximum boat-load. Generally, select a larger pitch propeller for a smaller operating load and a smaller pitch propeller for a heavier load. If you carry loads that vary widely, select the propeller that lets the engine run in the proper range for your maximum load but remember that you may need to reduce your throttle setting to stay within the recommended engine speed range when carrying lighter loads.

Yamaha recommends to use a propeller suitable for the "Shift Dampener System (SDS)". For further information, consult your Yamaha dealer.

To check the propeller, see page 71.

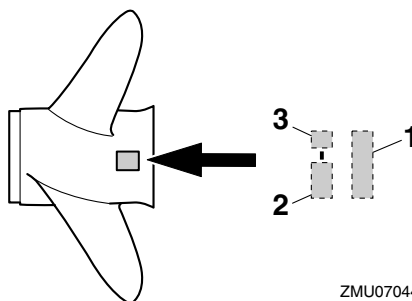

ZMU07044

1. Propeller diameter in inches
2. Propeller pitch in inches
3. Type of propeller (propeller mark)

EMU36310

### Counter rotation models

Standard outboard motors rotate clockwise. Counter rotation models rotate counterclockwise. Counter rotation models are typically used in multiple motor setups and are marked with an "L" on the gear case above the anti-ventilation plate.

On counter rotation models, be sure to use a propeller intended for counterclockwise rotation. These propellers are identified with the letter "L" after the size indication on the propeller. **WARNING! Never use a standard**

# Specifications and requirements

propeller with a counter rotation motor, or a counter rotation propeller with a standard motor. Otherwise the boat could go in the direction opposite of that expected (for example, reverse instead of forward), which could lead to an accident. <sup>[EWM01810]</sup>

For instructions on propeller removal and installation, see page 72 and 73.

EMU25770

## Start-in-gear protection

Yamaha outboard motors or Yamaha-approved remote control units are equipped with start-in-gear protection device(s). This feature permits the engine to be started only when it is in neutral. Always select neutral before starting the engine.

EMU41951

## Engine oil requirements

Select an oil grade according to the average temperatures in the area where the outboard motor will be used.

Recommended engine oil:

4-stroke outboard motor oil

Recommended engine oil grade 1:

SAE 10W-30/10W-40/5W-30

API SE/SF/SG/SH/SJ/SL

Recommended engine oil grade 2:

SAE 15W-40/20W-40/20W-50

API SH/SJ/SL

Total engine oil quantity (oil pan capacity):

5.6 L (5.92 US qt, 4.93 Imp.qt)

Replacement engine oil quantity (at periodic maintenance):

Without oil filter replacement:

4.5 L (4.76 US qt, 3.96 Imp.qt)

With oil filter replacement:

4.7 L (4.97 US qt, 4.14 Imp.qt)

If oil grades listed under Recommended engine oil grade 1 are not available, select an alternative oil grade listed under Recommended engine oil grade 2.

## Recommended engine oil grade 1

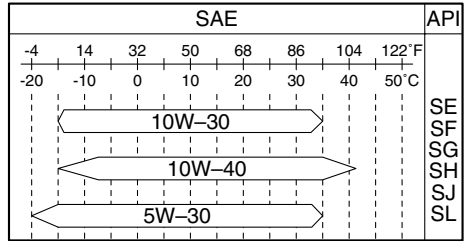

ZMU06854

## Recommended engine oil grade 2

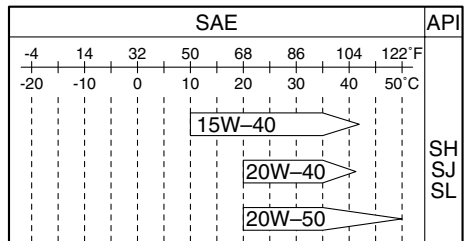

ZMU06855

EMU36360

## Fuel requirements

EMU43920

### Gasoline

#### F200C, FL200C, F225B, FL225B

Use a good quality gasoline that meets the minimum octane rating. If knocking or pinging occurs, use a different brand of gasoline or premium unleaded fuel.

Recommended gasoline:

Regular unleaded gasoline with a minimum octane rating of 90 (Research Octane Number).

#### F225C, F250A, FL250A

Use a good quality gasoline that meets the minimum octane rating.

# Specifications and requirements

Recommended gasoline:  
Premium unleaded gasoline with a minimum octane rating of 94 (Research Octane Number).

ECM01981

## NOTICE

- **Do not use leaded gasoline. Leaded gasoline can seriously damage the engine.**
- **Avoid getting water and contaminants in the fuel tank. Contaminated fuel can cause poor performance or engine damage. Use only fresh gasoline that has been stored in clean containers.**

## Gasohol

There are two types of gasohol: gasohol containing ethanol (E10) and that containing methanol. Ethanol can be used if the ethanol content does not exceed 10% and the fuel meets the minimum octane ratings. E85 is a fuel containing 85% ethanol and must not be used in your outboard motor. All ethanol blends containing more than 10% ethanol can cause fuel system damage or cause engine starting and running problems. Yamaha does not recommend gasohol containing methanol because it can cause fuel system damage or engine performance problems.

It is recommended that you install a water-separating marine fuel filter assembly (10 micron minimum) between your boat's fuel tank and outboard motor when using ethanol. Ethanol is known to allow moisture to be absorbed into boat fuel tanks and systems. Moisture in the fuel can cause corrosion of metallic fuel system components, starting and running complaints and require additional fuel system maintenance.

EMU36880

## Muddy or acidic water

Yamaha strongly recommends that you have your dealer install the optional chromium-plated water pump kit if you use the outboard motor in muddy or acidic water conditions. However, depending on the model it might not be required.

EMU36330

## Anti-fouling paint

A clean hull improves boat performance. The boat bottom should be kept as clean of marine growth as possible. If necessary, the boat bottom can be coated with an anti-fouling paint approved for your area to inhibit marine growth.

Do not use anti-fouling paint which includes copper or graphite. These paints can cause more rapid engine corrosion.

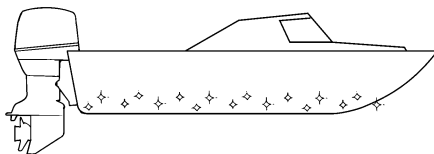

ZMU05176

EMU36341

## Motor disposal requirements

Never illegally discard (dump) the motor. Yamaha recommends consulting the dealer about discarding the motor.

EMU36352

## Emergency equipment

Keep the following items onboard in case there is trouble with the outboard motor.

- A tool kit with assorted screwdrivers, pliers, wrenches (including metric sizes), and electrical tape.
- Waterproof flashlight with extra batteries.

# Specifications and requirements

---

- An extra engine shut-off cord (lanyard) with clip.
- Spare parts, such as an extra set of spark plugs.

Consult your Yamaha dealer for details.

EMU2579Y

## Components diagram

### TIP:

\* May not be exactly as shown; also may not be included as standard equipment on all models (order from dealer).

**F200C, FL200C, F225B, FL225B, F225C, F250A, FL250A**

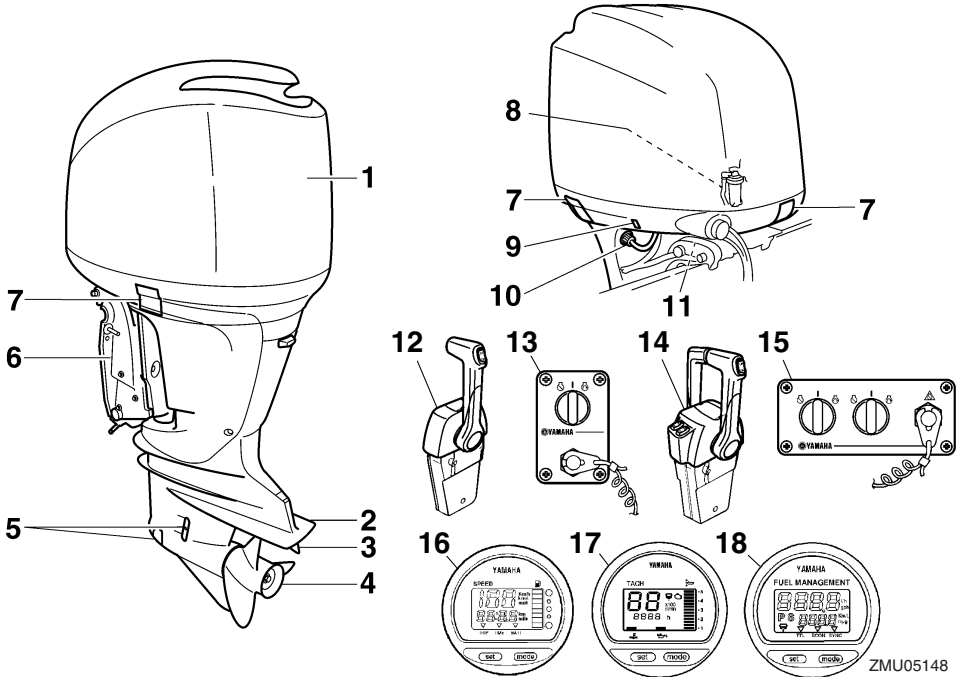

1. Top cowling
2. Anti-cavitation plate
3. Trim tab (anode)
4. Propeller\*
5. Cooling water inlet\*
6. Clamp bracket
7. Cowling lock lever(s)
8. Water separator
9. Power trim and tilt switch
10. Flushing device
11. Tilt support lever
12. Remote control box (binnacle mount type)\*
13. Switch panel (for use with binnacle type)\*
14. Remote control box (binnacle mount type)\*
15. Switch panel (for use with binnacle type)\*

16. Digital speedometer\*
17. Digital tachometer\*
18. Fuel management meter\*

ZMU05148

# Components

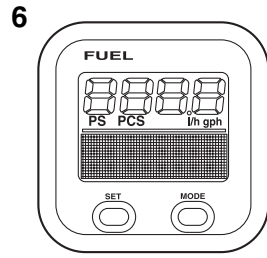
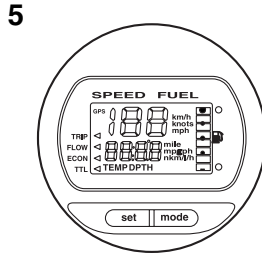
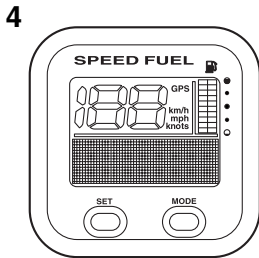
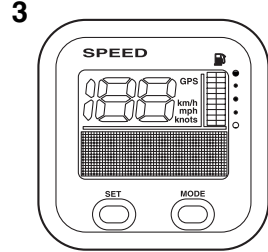
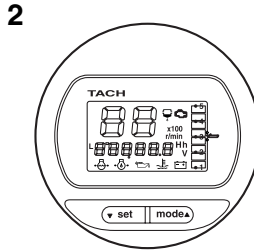
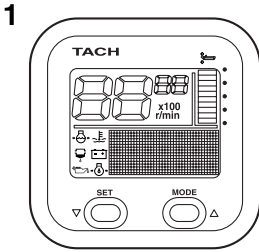

ZMU05429

1. Tachometer unit (Square type)\*
2. Tachometer unit (Round type)\*
3. Speedometer unit (Square type)\*
4. Speed & fuel meter unit (Square type)\*
5. Speed & fuel meter unit (Round type)\*
6. Fuel management meter (Square type)\*

EMU26181

## Remote control box

The remote control lever actuates both the shifter and the throttle. The electrical switches are mounted on the remote control box.

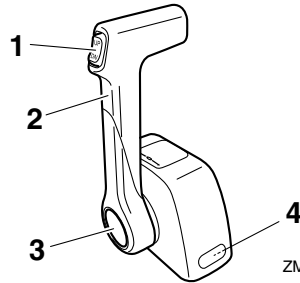

ZMU04572

1. Power trim and tilt switch
2. Remote control lever
3. Free accelerator
4. Throttle friction adjuster



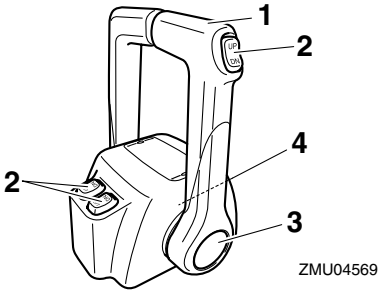

1. Remote control lever
2. Power trim and tilt switch
3. Free accelerator
4. Throttle friction adjuster

EMU26190

## Remote control lever

Moving the lever forward from the neutral position engages forward gear. Pulling the lever back from neutral engages reverse. The engine will continue to run at idle until the lever is moved about 35° (a detent can be felt). Moving the lever farther opens the throttle, and the engine will begin to accelerate.

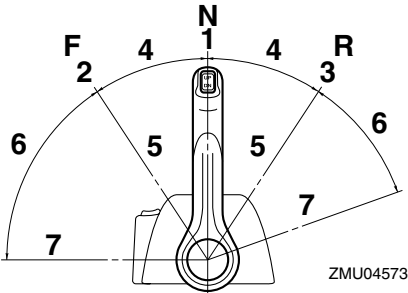

1. Neutral "N"
2. Forward "F"
3. Reverse "R"
4. Shift
5. Fully closed
6. Throttle
7. Fully open

EMU26233

## Free accelerator

To open the throttle without shifting into either forward or reverse, push the free accelerator button and move the remote control lever.

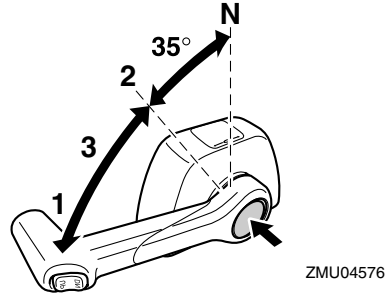

1. Fully open
2. Fully closed
3. Free accelerator

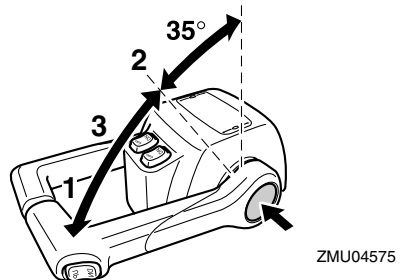

1. Fully open
2. Fully closed
3. Free accelerator

## TIP:

- The free accelerator button can only be pushed when the remote control lever is in the neutral position.
- After the button is pushed, the throttle begins to open after the remote control lever is moved at least 35°.
- After using the free accelerator, return the remote control lever to the neutral position. The free accelerator button will return auto-

# Components

matically to its set position. The remote control will then engage forward and reverse normally.

EMU25976

## Throttle friction adjuster

A friction device provides adjustable resistance to movement of the throttle grip or the remote control lever, and can be set according to operator preference.

To increase resistance, turn the adjuster clockwise. To decrease resistance, turn the adjuster counterclockwise. **WARNING! Do not overtighten the friction adjuster. If there is too much resistance, it could be difficult to move the remote control lever or throttle grip, which could result in an accident.** [EWM00032]

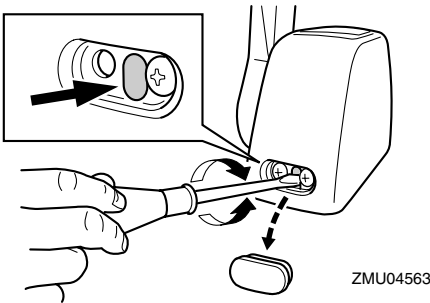

ZMU04563

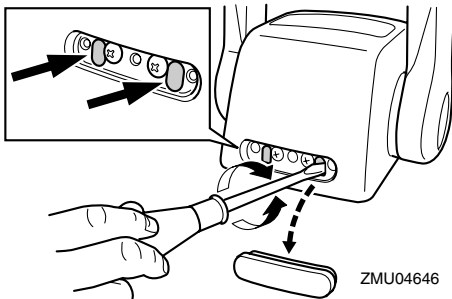

ZMU04646

When constant speed is desired, tighten the adjuster to maintain the desired throttle setting.

EMU25995

## Engine shut-off cord (lanyard) and clip

The clip must be attached to the engine shut-off switch for the engine to run. The cord should be attached to a secure place on the operator's clothing, or arm or leg. Should the operator fall overboard or leave the helm, the cord will pull out the clip, stopping ignition to the engine. This will prevent the boat from running away under power. **WARNING! Attach the engine shut-off cord to a secure place on your clothing, or your arm or leg while operating. Do not attach the cord to clothing that could tear loose. Do not route the cord where it could become entangled, preventing it from functioning. Avoid accidentally pulling the cord during normal operation. Loss of engine power means the loss of most steering control. Also, without engine power, the boat could slow rapidly. This could cause people and objects in the boat to be thrown forward.**

[EWM00122]

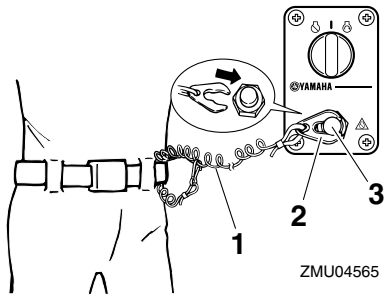

ZMU04565

1. Cord
2. Clip
3. Engine shut-off switch

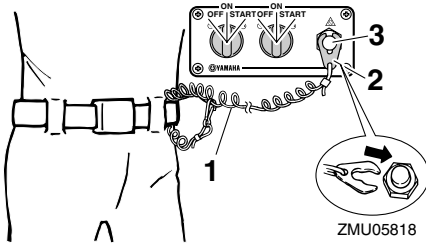

ZMU05818

1. Cord
2. Clip
3. Engine shut-off switch

EMU26091

## Main switch

The main switch controls the ignition system; its operation is described below.

- **“OFF” (off)**

With the main switch in the “OFF” (off) position, the electrical circuits are off, and the key can be removed.

- **“ON” (on)**

With the main switch in the “ON” (on) position, the electrical circuits are on, and the key cannot be removed.

- **“START” (start)**

With the main switch in the “START” (start) position, the starter motor turns to start the engine. When the key is released, it returns automatically to the “ON” (on) position.

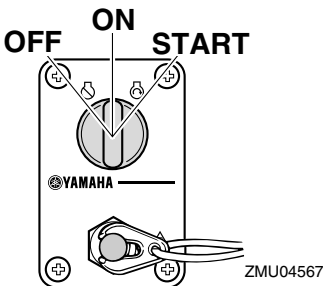

ZMU04567

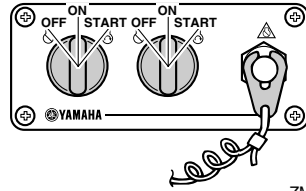

ZMU05821

EMU32053

## Power trim and tilt switch on remote control

The power trim and tilt system adjusts the outboard motor angle in relation to the transom. Pushing the switch “UP” (up) trims the outboard motor up, and then tilts it up. Pushing the switch “DN” (down) tilts the outboard motor down and trims it down. When the switch is released, the outboard motor will stop in its current position. For instructions on using the power trim and tilt switch, see pages 51 and 53.

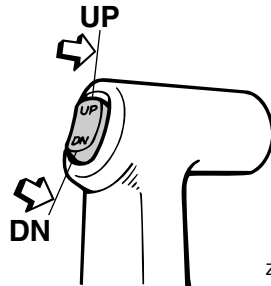

ZMU03938

EMU26155

## Power trim and tilt switch on bottom cowling

The power trim and tilt switch is located on the side of the bottom cowling. Pushing the switch “UP” (up) trims the outboard motor up, and then tilts it up. Pushing the switch “DN” (down)

# Components

tilts the outboard motor down and trims it down. When the switch is released, the outboard motor will stop in its current position. For instructions on using the power trim and tilt switch, see page 53.

EWMM01031

## **! WARNING**

Use the power trim and tilt switch located on the bottom cowling only when the boat is at a complete stop with the engine off. Attempting to use this switch while the boat is moving could increase the risk of falling overboard and could distract the operator, increasing the risk of collision with another boat or an obstacle.

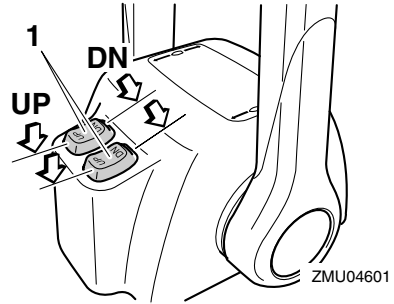

1. Power trim and tilt switch

## **TIP:**

On the dual engine control, the switch on the remote control grip controls both outboard motors at the same time.

EMU26244

## **Trim tab with anode**

EWMM00840

## **! WARNING**

An improperly adjusted trim tab could cause difficult steering. Always test run after the trim tab has been installed or replaced to be sure steering is correct. Be sure you have tightened the bolt after adjusting the trim tab.

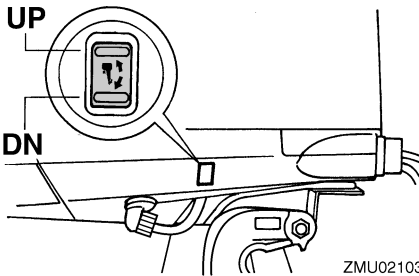

EMU26163

## **Power trim and tilt switches (twin binacle type)**

The power trim and tilt system adjusts the outboard motor angle in relation to the transom. Pushing the switch "UP" (up) trims the outboard motor up, and then tilts it up. Pressing the switch "DN" (down) tilts the outboard motor down and trims it down. When the switch is released, the outboard motor will stop in its current position. For instructions on using the power trim and tilt switches, see pages 51 and 53.

The trim tab should be adjusted so that the steering control can be turned to either the right or left by applying the same amount of force.

If the boat tends to veer to the left (port side), turn the trim tab rear end to the port side "A" in the figure. If the boat tends to veer to the right (starboard side), turn the trim tab end to the starboard side "B" in the figure.

ECM00840

## **NOTICE**

The trim tab also serves as an anode to protect the engine from electrochemical corrosion. Never paint the trim tab as it will become ineffective as an anode.

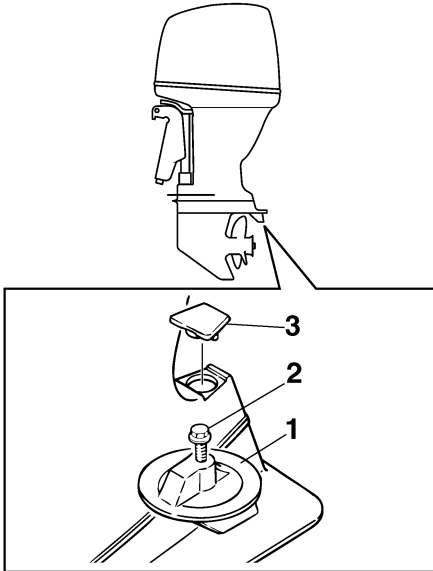

ZMU01730

1. Trim tab
2. Bolt
3. Cap

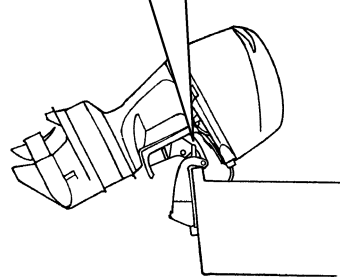
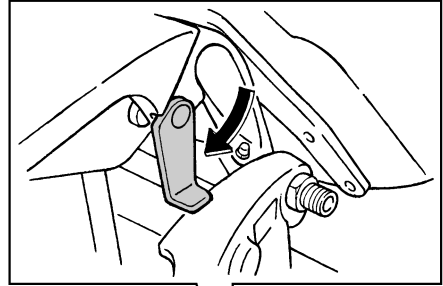

ZMU05352

ECM00660

## NOTICE

**Do not use the tilt support lever or knob when trailering the boat. The outboard motor could shake loose from the tilt support and fall. If the motor cannot be trailered in the normal running position, use an additional support device to secure it in the tilt position.**

EMU31421

## Cowling lock lever (pull up type)

To remove the top cowling, pull up the cowling lock lever(s) and lift off the cowling. To install the top cowling, place it in its original position, and then move the cowling lock lever(s) downward to lock it in place.

## TIP:

- When installing the cowling, check to be sure it fits properly in the rubber seal.

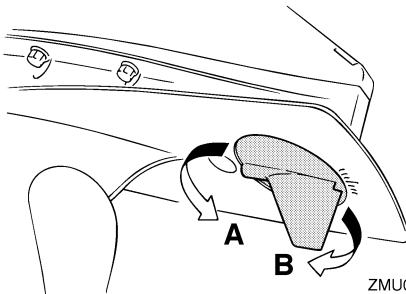

ZMU02104

**Bolt tightening torque:**  
42.0 Nm (4.28 kgf-m, 31.0 ft-lb)

EMU26341

## Tilt support lever for power trim and tilt model

To keep the outboard motor in the tilted up position, lock the tilt support lever to the clamp bracket.

# Components

- Be sure to check that the gap between the top cowling and the bottom cowling is even all around the cowling. If the top cowling is loose or the gap is not even, reinstall the cowling.

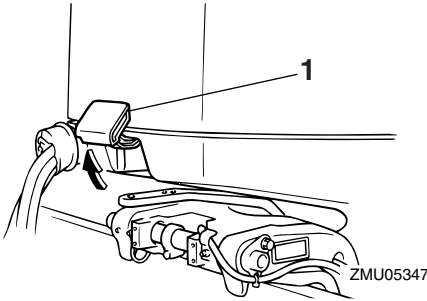

1. Cowling lock lever(s)

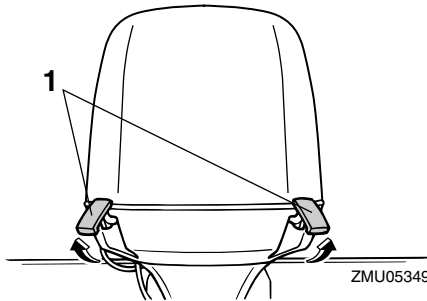

1. Cowling lock lever(s)

EMU26463

## Flushing device

This device is used to clean the cooling water passages of the motor using a garden hose and tap water.

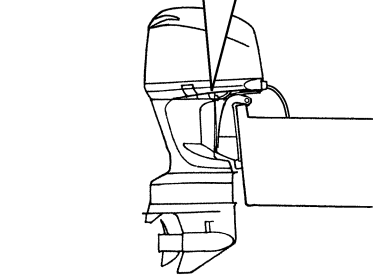
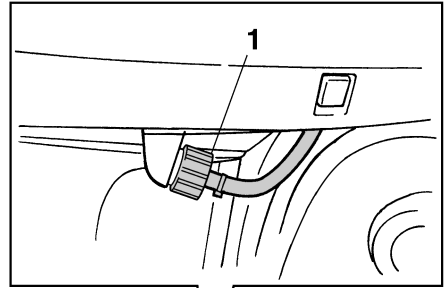

1. Flushing device

ZMU02108

## TIP:

For details on usage, see page 60.

EMU35563

## Fuel filter/Water separator

This engine has a combination fuel filter/water separator and associated alert system. If water separated from the fuel exceeds a specific volume, the alert device of 6Y8 Multifunction Tachometer will activate.

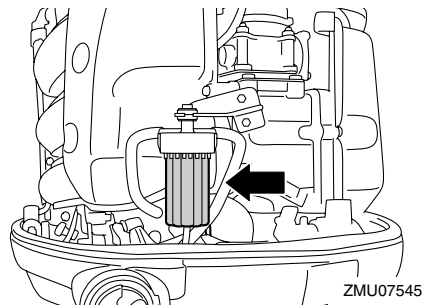

Activation of alert device

- The water separator-alert indicator of 6Y8 Multifunction Tachometer will blink.
- The buzzer will sound intermittently only when the gear shift is in neutral.
- If the alert system has activated, stop the engine and consult a Yamaha dealer immediately.

# Instruments and indicators

EMU31414

## Digital tachometer

The tachometer shows the engine speed and has the following functions.

All segments of the display will light momentarily after the main switch is turned on and will return to normal thereafter.

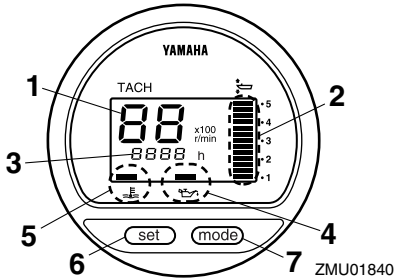

1. Tachometer
2. Trim meter
3. Hour meter
4. Low oil pressure-alert indicator
5. Overheat-alert indicator
6. Set button
7. Mode button

### TIP:

The water separator-alert indicator and engine trouble-alert indicator on the digital tachometer do not operate for this engine.

EMU36050

## Tachometer

The tachometer displays engine speed in hundreds of revolutions per minute (r/min). For example, if the tachometer display reads "22" then the engine speed is 2200 r/min.

EMU26621

## Trim meter

This meter shows the trim angle of your outboard motor.

- Memorize the trim angles that work best for your boat under different conditions. Adjust the trim angle to the desired using the power trim and tilt switch.

- If the trim angle of your motor exceeds the trim operating range, the top segment on the trim meter display will blink.

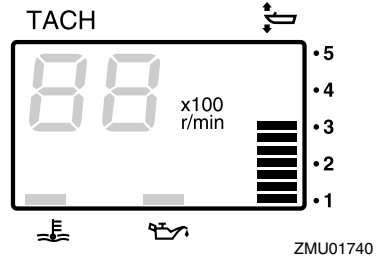

EMU26651

## Hour meter

This meter shows the number of hours the engine has been run. It can be set to show the total number of hours or the number of hours for the current trip. The display can also be turned on and off.

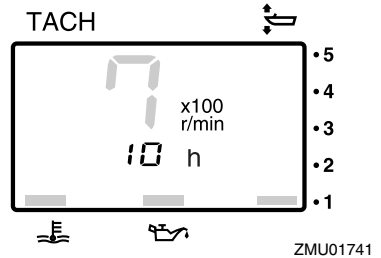

To change the display format, press the "mode" (mode) button. The display can show total hours or trip hours, or turn off.

To reset the trip hours, simultaneously press the "set" (set) and "mode" (mode) buttons for more than 1 second while the trip hours are displayed. This resets the trip counter to 0 (zero).

The total number of hours the engine has been run cannot be reset.



# Instruments and indicators

EMU26524

## Low oil pressure-alert indicator

If oil pressure drops too low, the alert indicator will start to blink. For further information, see page 37.

ECM00022

### NOTICE

- Do not continue to run the engine if the low oil pressure-alert indicator is on and the engine oil level is lower. Serious engine damage will occur.
- The low oil pressure-alert indicator does not indicate the engine oil level. Use the oil dipstick to check the remaining oil quantity. For further information, see page 43.

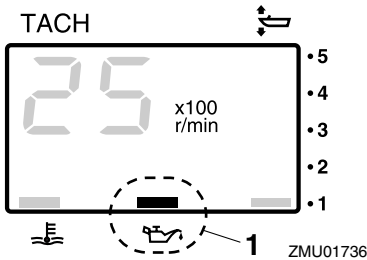

1. Low oil pressure-alert indicator

EMU26583

## Overheat-alert indicator

If the engine temperature rises too high, the alert indicator will start to blink. For further information on reading the indicator, see page 37.

ECM00052

### NOTICE

Do not continue to run the engine if the overheat-alert indicator is on. Serious engine damage will occur.

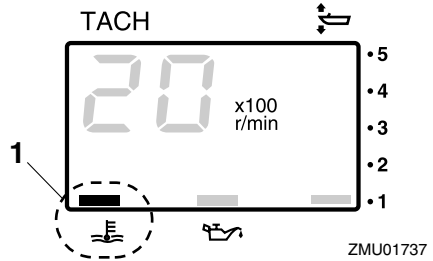

1. Overheat-alert indicator

EMU26602

## Digital speedometer

This gauge shows the boat speed and other information.

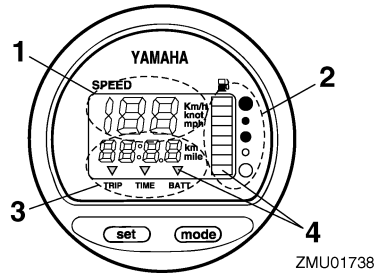

1. Speedometer
2. Fuel gauge
3. Trip meter/clock/voltmeter
4. Alert indicator(s)

All segments of the display will light momentarily after the main switch is turned on and will return to normal thereafter.

EMU36061

## Speedometer

The speedometer displays km/h, mph, or knots, according to operator preference. Select the desired units of measurement by setting the selector switch on the back of the gauge. See the illustration for settings.

# Instruments and indicators

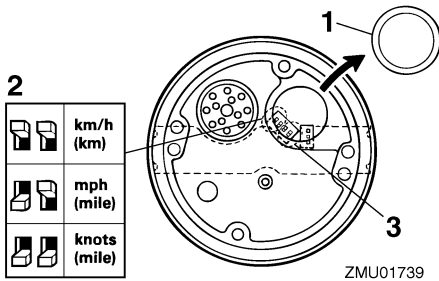

ZMU01739

1. Cap
2. Selector switch (for speed unit)
3. Selector switch (for fuel sensor)

EMU26713

## Fuel gauge

Eight segments indicate the fuel level. When all segments are showing, the fuel tank is full.

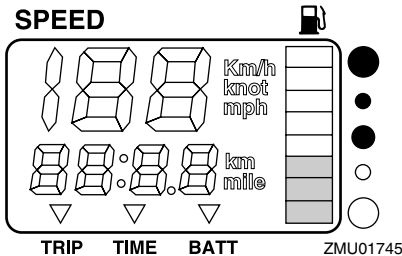

ZMU01745

The fuel level reading can be inaccurate due to the position of the sensor in the fuel tank and the attitude of the boat in the water. Operation with bow-up trim or continuous turning can give false readings.

Do not adjust the selector switch for fuel sensor. Incorrectly setting the selector switch on the gauge will give false readings. Consult your Yamaha dealer on how to correctly set the selector switch. **NOTICE: Running out of fuel can damage the engine.** [ECM01770]

EMU36071

## Trip meter / Clock / Voltmeter

The display shows either the trip meter, the clock, or the voltmeter.

To change the display, press the “mode” (mode) button repeatedly until the indicator on the face of the gauge points to “TRIP” (trip meter), “TIME” (clock), or “BATT” (voltmeter).

EMU26691

## Trip meter

This gauge displays the distance the boat has traveled since the gauge was last reset.

The trip distance is shown in kilometers or miles depending upon the unit of measurement selected for the speedometer.

To reset the trip meter to zero, press the “set” (set) and “mode” (mode) buttons at the same time.

The trip distance is kept in memory by battery power. The stored data will be lost if the battery is disconnected.

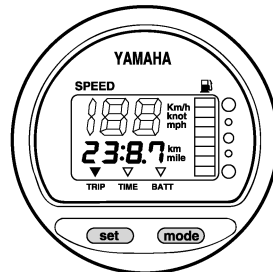

ZMU01743

EMU26701

## Clock

To set the clock:

1. Be sure the gauge is in the “TIME” (time) mode.
2. Press the “set” (set) button; the hour display will begin blinking.
3. Press the “mode” (mode) button until the desired hour is displayed.
4. Press the “set” (set) button again, the minute display will begin blinking.
5. Press the “mode” (mode) button until the desired minute is displayed.
6. Press the “set” (set) button again to start the clock.

# Instruments and indicators

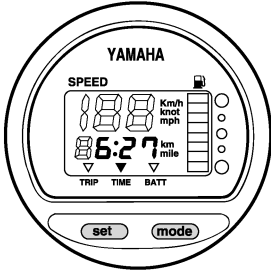

ZMU01744

The clock operates on battery power. Disconnecting the battery will stop the clock. Reset the clock after connecting the battery.

EMU36080

## Voltmeter

The voltmeter displays the charge of the battery in volts(V).

EMU26721

## Fuel level-alert indicator

If the fuel level decreases to one segment, the fuel level alert segment will blink.

Do not continue to operate the engine with full throttle if an alert device has activated. Get back to the port within trolling engine speed.

**NOTICE: Running out of fuel can damage the engine.** [ECM01770]

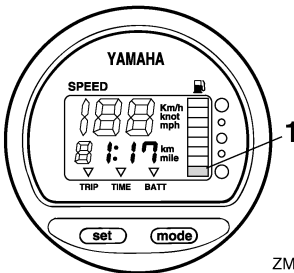

ZMU01746

1. Fuel level-alert segment

EMU26732

## Low battery voltage-alert indicator

If battery voltage drops, the display will automatically turn on and blink.

Get back to the port soon if an alert device has activated. For charging the battery, consult your Yamaha dealer.

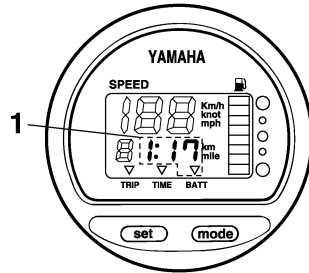

ZMU01747

1. Low battery indicator

EMU26741

## Fuel management meter

The fuel management meter shows the state of the fuel consumption while the engine is running.

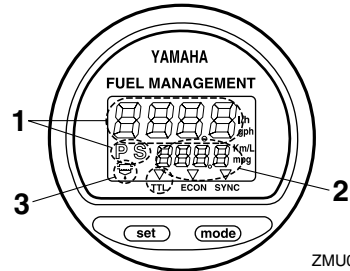

ZMU01748

1. Fuel flow meter
2. Fuel consumption meter / Fuel economy meter / Twin engine speed synchronizer
3. Water separator-alert indicator (operates only if the sensor has been installed)

All segments of the display will light momentarily after the main switch is turned on and will return to normal thereafter.

EMU26752

## Fuel flow meter

The fuel flow meter displays the amount of fuel flow over a one-hour period, at the current rate of engine operation.

# Instruments and indicators

- The fuel flow meter displays gallons/hour or liters/hour according to operator preference. Select the desired units of measurement by setting the selector switch on the back of the gauge during installation.

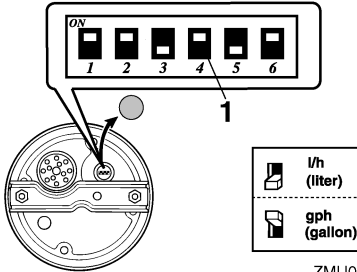

ZMU01750

1. Selector switch

- The fuel consumption meter and fuel economy meter will indicate the same unit of measurement.

Fuel flow readings are not accurate when the engine is operating under about 1300 r/min. As the fuel pump cycles on and off, the display indicates either no fuel flow or higher flow than the actual average use.

Dual engine users: the fuel flow meter can display the fuel flow of either or both engines.

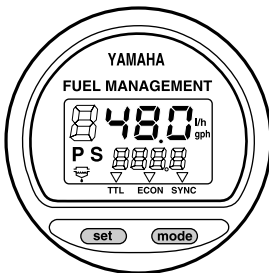

ZMU01749

To change the fuel flow display, press the “set” (set) button repeatedly until the gauge displays “S” (for fuel flow to the starboard engine only), “P” (for fuel flow to the port engine only), or “P S” (for total fuel flow both engines).

EMU36090

## Fuel consumption meter / Fuel economy meter / Twin engine speed synchronizer

The display shows either the fuel consumption meter, the fuel economy meter, or the twin engine synchronizer.

To change the display, press the “mode” (mode) button repeatedly until the indicator on the face of the gauge points to “TTL” (fuel consumption meter), “ECON” (fuel economy meter), or “SYNC” (twin engine speed synchronizer).

EMU26761

### Fuel consumption meter

This gauge displays the total amount of fuel consumed since the gauge was last reset.

To reset the total fuel consumption meter to zero, press the “set” (set) and “mode” (mode) buttons at the same time.

## FUEL MANAGEMENT

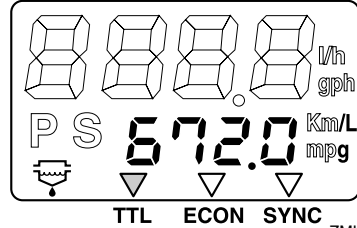

ZMU01751

EMU26771

### Fuel economy

This gauge displays the approximate distance per liter or gallon when cruising.

# Instruments and indicators

## FUEL MANAGEMENT

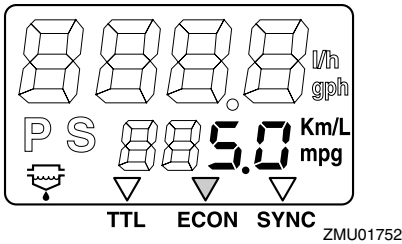

ZMU01752

If twin engines are installed on your boat, the gauge will only display the total fuel economy of both engines.

- Fuel consumption varies greatly with boat design, weight, propeller used, engine trim angle, sea conditions (including wind), and throttle position. Fuel consumption also varies slightly with the type of water (salt, fresh, and contaminate levels), air temperature and humidity, cleanliness of the boat bottom, engine mounting height, skill of the operator, and individual gasoline formulation (winter or summer fuel and amount of additives).
- The Yamaha digital speedometer and fuel management meter calculates speed, miles traveled, and fuel economy by water movement at the stern of the boat. This distance can vary greatly from the actual distance traveled because of water currents, sea swells, and the condition of the water speed sensor (if partially plugged or damaged).
- Individual engines may slightly vary in their fuel consumption due to manufacturing variations. These variations can be even greater if the engines are of different year models. In addition, variations in propellers, even of the same basic dimensions of the same design, can also cause a slight variation in fuel consumption.

EMU26782

## Twin-engine speed synchronizer

This gauge displays the difference in engine speed (r/min) between the port and starboard engines for reference purposes when synchronizing the two engines' speeds.

## FUEL MANAGEMENT

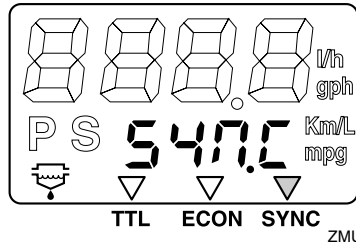

ZMU01753

## FUEL MANAGEMENT

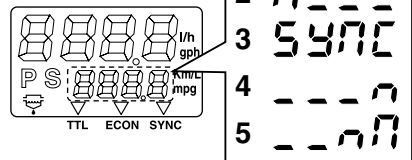

ZMU01754

If the two engines' speeds are not synchronized while cruising, adjusting trim angle or throttle can synchronize them.

If large differences in trim angle or throttle are needed to synchronize the engines, consult your Yamaha dealer for adjustments to the throttle cables.

# Instruments and indicators

EMU26793

## Water separator-alert indicator

This indicator will blink when water has accumulated in the water separator. In such an event, stop the engine and drain the water from the separator.

This indicator only operates when a water separator sensor is equipped.

## FUEL MANAGEMENT

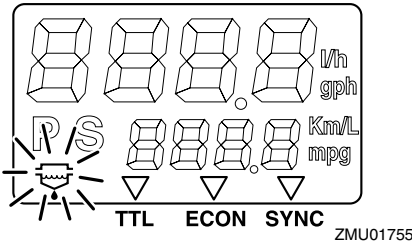

EMU31653

## 6Y8 Multifunction meters

Multifunction meters have 6 kinds of meter units; tachometer unit (square or round types), speedometer unit (square type), speed & fuel meter unit (square or round types), and fuel management meter (square type). The indicator system is slightly different between the round and square types. Check the model and type of your unit carefully. This manual describes mainly the alert indicators. For more details on setting meters or changing indicator systems, see the attached operation manual.

EMU36184

## 6Y8 Multifunction tachometers

The tachometer shows the engine revolutions per minute. It has functions of trim meter, adjusting trolling speed, cooling water/engine temperature display, battery voltage display, total hour/trip hour display, oil pressure display, water detection alert, engine trouble alert, and periodic maintenance notification. If the cooling water pressure sensor is installed,

the unit can also show the cooling water pressure display. However, even if the cooling water pressure sensor is not installed, the cooling water pressure display can be shown by connecting an optional sensor to the unit. For the optional sensor, consult your Yamaha dealer. The tachometer unit is available in round or square types. Check your tachometer unit type.

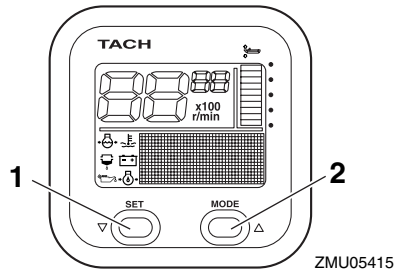

1. Set button
2. Mode button

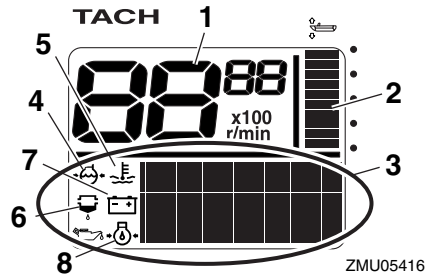

1. Tachometer
2. Trim meter
3. Multifunction display
4. Cooling water pressure
5. Cooling water/engine temperature
6. Water detection-alert indicator
7. Battery voltage
8. Oil pressure (4-stroke models)

# Instruments and indicators

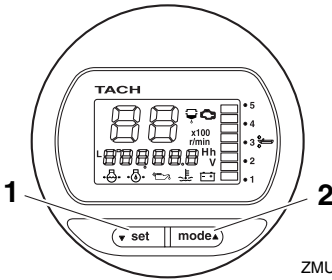

ZMU05417

1. Set button
2. Mode button

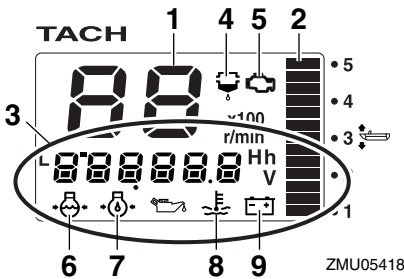

ZMU05418

1. Tachometer
2. Trim meter
3. Multifunction display
4. Water detection-alert indicator
5. Engine trouble alert/maintenance indicator
6. Cooling water pressure
7. Oil pressure (4-stroke models)
8. Cooling water/engine temperature
9. Battery voltage

EMU36110

## Start-up checks

Place the remote control lever in neutral and turn the main switch to "ON" (on). After all the displays come on and the total hour display comes on, the gauge will change to normal operation. If the buzzer sounds and the water separator-alert indicator blinks, consult your Yamaha dealer immediately.

## TIP:

To stop the buzzer, press the "set" (set) or "mode" (mode) button.

EMU36130

## Low oil pressure-alert

If the engine oil pressure drops too low, the low oil pressure-alert indicator will start to blink, and the engine speed will automatically decrease to about 2000 r/min.

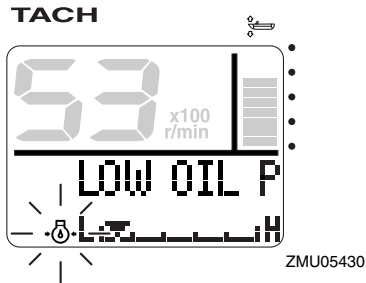

ZMU05430

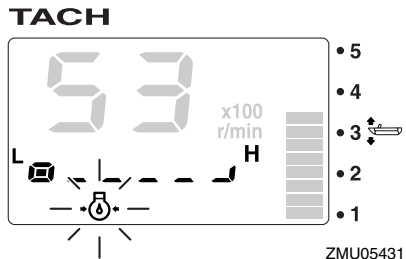

ZMU05431

Stop the engine immediately if the buzzer sounds and the low oil pressure-alert indicator blinks. Check the engine oil quantity and replenish oil if necessary. If the alert device has activated while the appropriate engine oil quantity is maintained, consult your Yamaha dealer.

ECM01601

## NOTICE

**Do not continue to run the engine if the low oil pressure alert device has activated. Serious engine damage will occur.**

# Instruments and indicators

EMU36221

## Overheat alert

If the engine temperature rises too high while cruising, the overheat-alert indicator will start to blink. The engine speed will automatically decrease to about 2000 r/min.

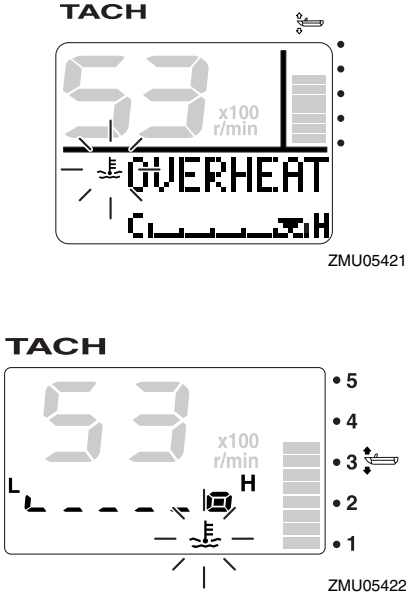

Stop the engine immediately if the buzzer sounds and the overheat alert device has activated. Check the cooling water inlet for clogging.

ECM01592

## NOTICE

- Do not continue to run the engine if the overheat-alert indicator blinks. Serious engine damage will occur.
- Do not continue to operate the engine if a alert device has activated. Consult your Yamaha dealer if the problem cannot be located and corrected.

EMU36150

## Water separator alert

This indicator will blink if water has accumulated in the water separator (fuel filter) while cruising. In such an event, stop the engine immediately and see page 84 of this manual to drain the water from the fuel filter. Get back to the port soon and consult a Yamaha dealer immediately.

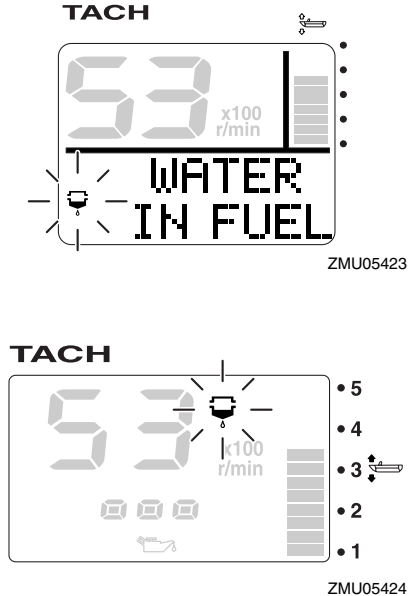

ECM00910

## NOTICE

Gasoline mixed with water could cause damage to the engine.

EMU36160

## Engine trouble alert

This indicator will blink if the engine malfunctions while cruising. Get back to the port soon and consult a Yamaha dealer immediately.



# Instruments and indicators

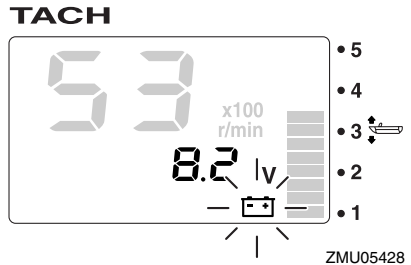
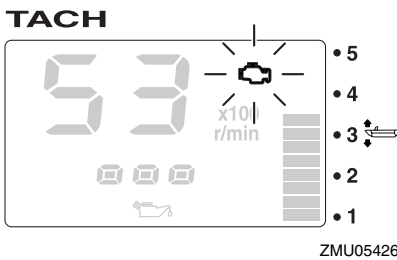
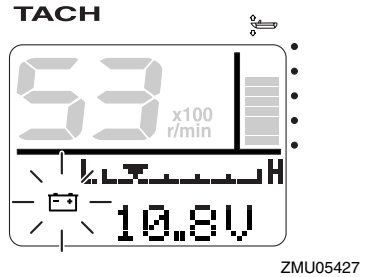
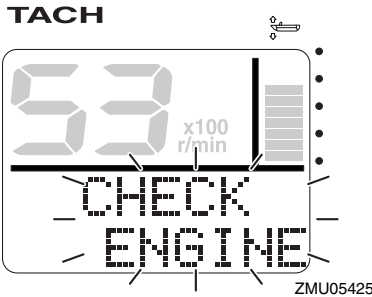

ECM00920

## NOTICE

In such an event, the engine will not operate properly. Consult a Yamaha dealer immediately.

EMU36170

## Low battery voltage-alert

If the battery voltage drops, the low battery voltage-alert indicator and the battery voltage value will start to blink. Get back to the port soon if the low battery voltage-alert device has activated. For charging the battery, consult your Yamaha dealer.

EMU36232

## 6Y8 Multifunction speed & fuel meters

The speed & fuel meter unit shows the boat speed and has the functions of fuel meter, total fuel consumption display, fuel economy display, fuel flow display, and system voltage display. The chosen display is selected by using the “set” (set) and “mode” (mode) buttons as described in this section. If the speed sensor is installed, the unit can also show the trip display. However, even if the speed sensor is not installed, the trip display can be shown by connecting an optional sensor to the unit. In addition, if optional sensors are connected to the unit, water surface temperature display, depth display, and clock will also be available. For the optional sensors, consult your Yamaha dealer.

# Instruments and indicators

The speed & fuel meter unit is available in round or square types. Check your speed & fuel meter unit type for operation information. After the main switch is first turned on, all the displays come on as a test. After a few seconds, the gauge will change to normal operation.

For more information, see the operation manual originally supplied with the meter.

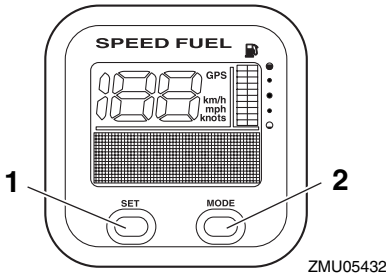

1. Set button
2. Mode button

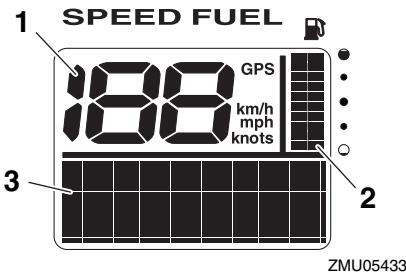

1. Speedometer
2. Fuel meter
3. Multifunction display

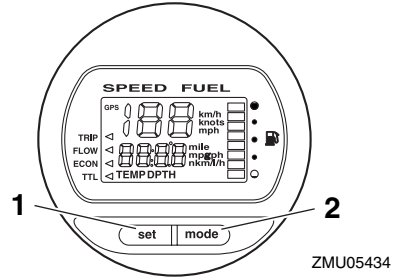

1. Set button
2. Mode button

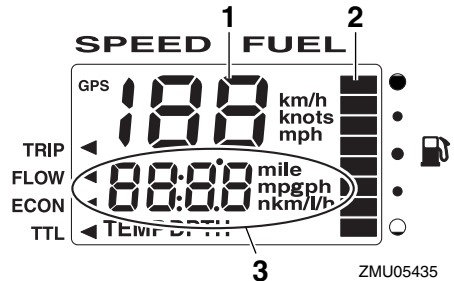

1. Speedometer
2. Fuel meter
3. Multifunction display

EMU36241

## 6Y8 Multifunction speedometers

The speedometer unit shows the boat speed and has functions of fuel meter and system voltage display. The chosen display is selected by using the “set” (set) and “mode” (mode) buttons as described in this section. In addition, the speedometer can show the desired unit of measurement such as km/h, mph, or knots. If the speed sensor is installed, the unit can also show the trip display. However, even if the speed sensor is not installed, the trip display can be shown by connecting an optional sensor to the unit. In addition, if optional sensors are connected to the unit, water surface

# Instruments and indicators

temperature display, depth display, and clock will also be available. For the optional sensors, consult your Yamaha dealer.

After the main switch is first turned on, all the displays come on as a test. After a few seconds, the gauge will change to normal operation.

For more information, see the operation manual originally supplied with the meter.

buttons as described in this section. For more information, see the operation manual originally supplied with the meter.

After the main switch is first turned on, all the displays come on as a test. After a few seconds, the gauge will change to normal operation.

For more information, see the operation manual originally supplied with the meter.

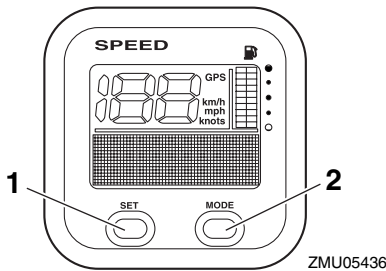

1. Set button
2. Mode button

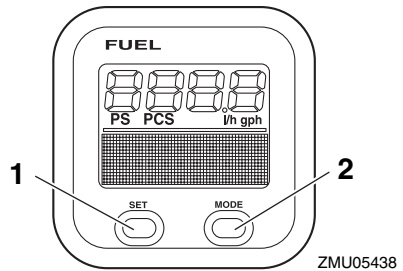

1. Set button
2. Mode button

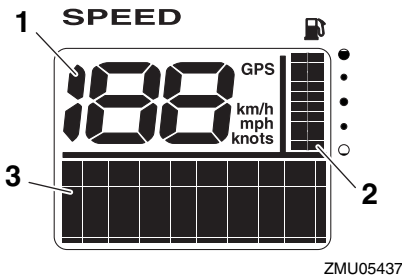

1. Speedometer
2. Fuel meter
3. Multifunction display

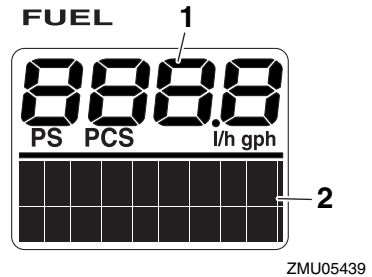

1. Fuel flow meter
2. Multifunction display

EMU36250

## 6Y8 Multifunction fuel management meters

The fuel management meter has the functions of fuel flow meter, total consumption display, fuel economy display, and remaining fuel display. The chosen display is selected by using the “set” (set) and “mode” (mode)

# Engine control system

EMU26803

## Alert system

ECM0091

### NOTICE

**Do not continue to operate the engine if a alert device has activated. Consult your Yamaha dealer if the problem cannot be located and corrected.**

EMU26827

### Overheat alert

This engine has the overheat alert device. If the engine temperature rises too high, the alert device will activate.

- The engine speed will automatically decrease to about 2000 r/min.
- The overheat-alert indicator will light or blink.

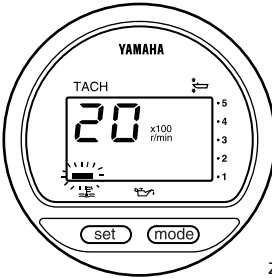

ZMU01757

- The buzzer will sound.

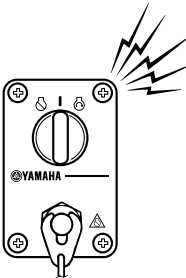

ZMU04583

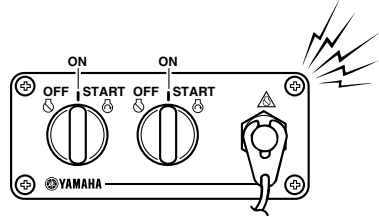

ZMU05827

If the alert system has activated, stop the engine and check the cooling water inlets:

- Check trim angle to be sure that the cooling water inlet is submerged.
- Check the cooling water inlet for clogging.

Dual engine drive users:

If the overheat-alert system of one engine activates, the engine will slow down. To switch off the alert activation on the engine not affected by overheating, turn off the main switch of the engine overheating. If the alert system has activated, stop the engine and tilt the outboard motor up to check the cooling water inlet for clogging. If the alert system has still activated, tilt the overheated outboard motor up and return to the port.

EMU35025

### Low oil pressure alert

If the oil pressure drops too low, the alert device will activate.

- The engine speed will automatically decrease to about 2000 r/min. The low oil pressure-alert indicator will light or blink.

# Engine control system

alert activation on the engine not affected by low oil pressure, turn off the main switch of the engine with the low oil pressure.

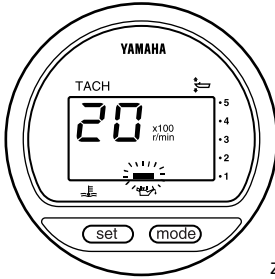

ZMU01828

- The buzzer will sound.

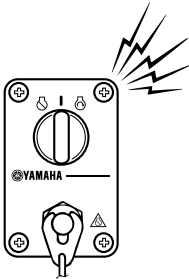

ZMU04583

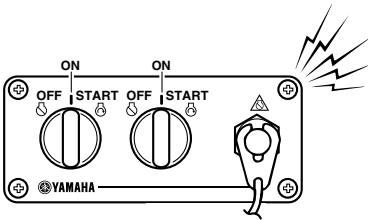

ZMU05827

If the alert system has activated, stop the engine as soon as it is safe to do so. Check the oil level and add oil as needed. If the oil level is correct and the alert device does not switch off, consult your Yamaha dealer.

Twin engine drive users:

If the low oil pressure alert system of one engine activates, both engines will slow down and the buzzer will sound. To switch off the

# Installation

EMU26902

## Installation

The information presented in this section is intended as reference only. It is not possible to provide complete instructions for every possible boat and motor combination. Proper mounting depends in part on experience and the specific boat and motor combination.

EWM01590

### **WARNING**

- **Overpowering a boat could cause severe instability. Do not install an outboard motor with more horsepower than the maximum rating on the capacity plate of the boat. If the boat does not have a capacity plate, consult the boat manufacturer.**
- **Improper mounting of the outboard motor could result in hazardous conditions such as poor handling, loss of control, or fire hazards. For permanently mounted models, your dealer or other person experienced in proper rigging should mount the motor.**

EMU33481

### **Mounting the outboard motor**

The outboard motor should be mounted so that the boat is well balanced. Otherwise, the boat could be hard to steer. For single-engine boats, mount the outboard motor on the centerline (keel line) of the boat. For twin engine boats, mount the outboard motors equidistant from the centerline. Consult your Yamaha dealer or boat manufacturer for further information on determining the proper mounting location.

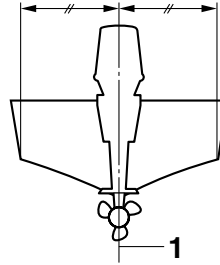

ZMU01760

1. Center line (keel line)

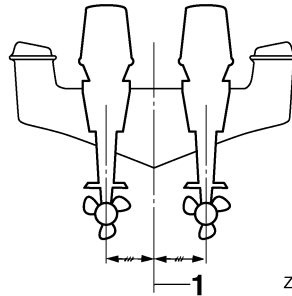

ZMU05141

1. Center line (keel line)

EMU26933

### **Mounting height (boat bottom)**

The mounting height of your outboard motor affects its efficiency and reliability. If it is mounted too high, propeller ventilation may occur, which will reduce propulsion due to excessive propeller slip, and the water intakes for the cooling system may not get adequate water supply, which can cause engine overheating. If the engine is mounted too low, water resistance (drag) will increase, thereby reducing engine efficiency and performance. Most commonly, outboard motor should be mounted so that the anti-cavitation plate is in alignment with the bottom of the boat. The optimum mounting height of the outboard motor is affected by the boat/motor combination and the desired use. Test runs at different heights can help determine the optimum mounting

height. Consult your Yamaha dealer or boat manufacturer for further information on determining the proper mounting height.

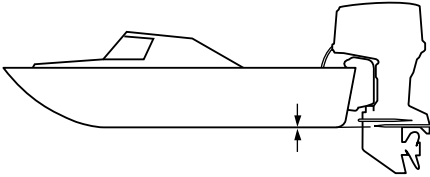

ZMU01762

ECM01634

## **NOTICE**

- Make sure that the idle hole is high enough to prevent water from entering the engine even if the boat is stationary with the maximum load.
  - Incorrect engine height or obstructions to the smooth flow of water (such as the design or condition of the boat, or accessories, such as transom ladders or depth finder transducers) can create airborne water spray while the boat is cruising. If the outboard motor is operated continuously in the presence of airborne water spray, enough water could enter the engine through the air intake opening in the top cowling to cause severe engine damage. Remove the cause of the airborne water spray.
-

# Operation

EMU36381

## First-time operation

EMU36391

### Fill engine oil

The engine is shipped from the factory without engine oil. If your dealer did not fill the oil, you must fill it before starting the engine. **NOTICE: Check that the engine is filled with oil before first-time operation to avoid severe engine damage.** [ECM01781]

The engine is shipped with the following sticker, which should be removed after engine oil is filled for the first time. For more information on checking the engine oil level, see page 43.



ZMU01710

EMU30174

### Breaking in engine

Your new engine requires a period of break-in to allow mating surfaces of moving parts to wear in evenly. Correct break-in will help ensure proper performance and longer engine life. **NOTICE: Failure to follow the break-in procedure could result in reduced engine life or even severe engine damage.** [ECM00801]

EMU27085

### Procedure for 4-stroke models

Your new engine requires a period of 10 hours break-in to allow mating surfaces of moving parts to wear in evenly.

#### TIP:

Run the engine in the water, under load (in gear with a propeller installed) as follows. For 10 hours for breaking in engine avoid extended idling, rough water and crowded areas.

1. For the first hour of operation:  
Run the engine at varying speeds up to 2000 r/min or approximately half throttle.
2. For the second hour of operation:  
Increase engine speed as much as necessary to put the boat on plane (but avoid full-throttle operation), then back off on the throttle while keeping the boat at a planing speed.
3. Remaining 8 hours:  
Run the engine at any speed. However, avoid operating at full throttle for more than 5 minutes at a time.
4. After the first 10 hours:  
Operate the engine normally.

EMU36400

### Getting to know your boat

Different boats handle differently. Operate cautiously while you learn how your boat handles under different conditions and with different trim angles (see page 51).

EMU36413

### Checks before starting engine

EWMM01921



If any item in “Checks before starting engine” is not working properly, have it inspected and repaired before operating the outboard motor. Otherwise, an accident could occur.

ECM00120

### NOTICE

Do not start the engine out of water. Overheating and serious engine damage can occur.

EMU36421

### Fuel level

Be sure you have plenty of fuel for your trip. A good rule is to use 1/3 of your fuel to get to the destination, 1/3 to return, and to keep 1/3 as an emergency reserve. With the boat level on



a trailer or in the water, turn the key to "ON" (on) and check the fuel level. For fuel filling instructions, see page 46.

EMU36432

## Remove cowling

For the following checks, remove the top cowling from the engine. To remove the engine cowling, release all the lock levers and lift off the cowling.

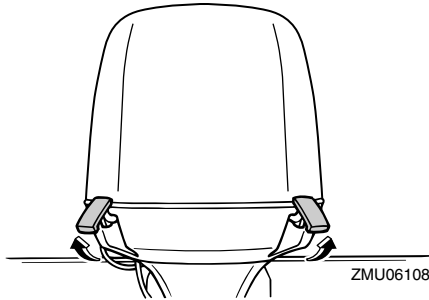
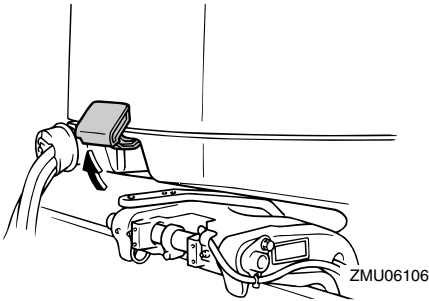

EMU36442

## Fuel system

EWMO0060

### **WARNING**

Gasoline and its vapors are highly flammable and explosive. Keep away from sparks, cigarettes, flames, or other sources of ignition.

EWMO0910

### **WARNING**

Leaking fuel can result in fire or explosion.

- Check for fuel leakage regularly.

- If any fuel leakage is found, the fuel system must be repaired by a qualified mechanic. Improper repairs can make the outboard unsafe to operate.

EMU36451

## Check for fuel leaks

- Check for fuel leaks or gasoline fumes in the boat.
- Check for fuel leakage from the fuel system.
- Check the fuel tank and fuel lines for cracks, swellings, or other damages.

EMU37322

## Checking the fuel filter

Check that the fuel filter is clean and free of water. If any water is found in the fuel, or if a significant amount of debris is found, the fuel tank should be checked and cleaned by a Yamaha dealer.

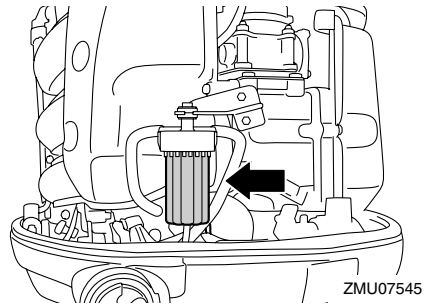

EMU36462

## Controls

- Turn the steering wheel full-right and full-left. Make sure operation is smooth and unrestricted throughout the whole range with no binding or excessive free play.
- Operate the throttle levers several times to make sure there is no hesitation in their travel. Operation should be smooth over the complete range of motion, and each lever should return completely to the idle position.
- Look for loose or damaged connections of the throttle and shift cables.

# Operation

EMU36483

## Engine shut-off cord (lanyard)

Inspect the engine shut-off cord and clip for damage, such as cuts, breaks, and wear.

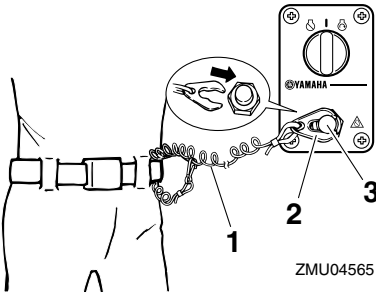

ZMU04565

1. Cord
2. Clip
3. Engine shut-off switch

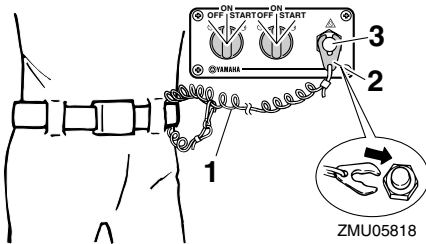

ZMU05818

1. Cord
2. Clip
3. Engine shut-off switch

EMU37053

## Engine oil

1. Put the outboard motor in an upright position (not tilted). **NOTICE: If the motor is not level, the oil level indicated on the dipstick may not be accurate.**

[ECM01790]

2. Remove oil dipstick and wipe it clean.
3. Insert the dipstick and remove it again. Be sure to completely insert the dipstick into the dipstick guide, otherwise the oil level measurement will be incorrect.

4. Check the oil level using the dipstick to be sure the level falls between the upper level mark and lower level mark. Consult your Yamaha dealer if the oil level is out of specified level or if it appears milky or dirty.

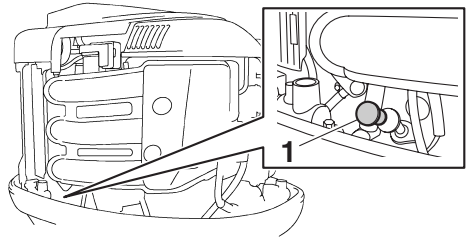

ZMU05972

1. Oil dipstick

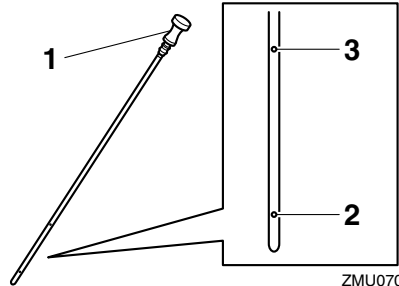

ZMU07057

1. Oil dipstick
2. Lower level mark
3. Upper level mark

EMU27153

## Engine

- Check the engine and engine mounting.
- Look for loose or damaged fasteners.
- Check the propeller for damage.
- Check for engine oil leaks.

EMU36493

## Flushing device

Check that the flushing device's garden hose connector is securely screwed on to the fitting on the bottom cowling. **NOTICE: If the garden hose connector is not properly con-**

nected, cooling water can leak out and the engine can overheat during operation.

[ECM01801]

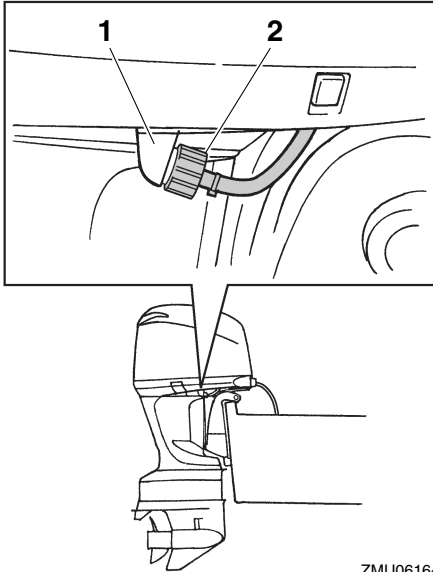

1. Fitting
2. Flushing device

EMU36941

## Install cowling

1. Be sure that all cowling lock levers are released.
2. Be sure that the rubber seal is seated all the way around the engine.
3. Place the cowling on top of the seal.
4. Check to be sure it fits properly in the rubber seal.
5. Move the levers to lock the cowling as shown. **NOTICE: If the top cowling is not installed correctly, water spray under the top cowling can damage the engine, or the top cowling can blow off at high speeds.** [ECM01991]

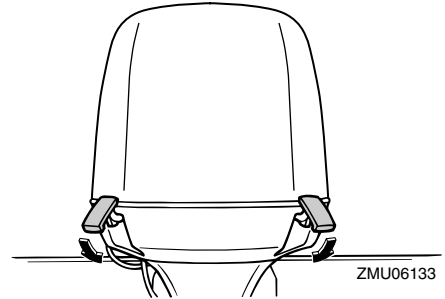
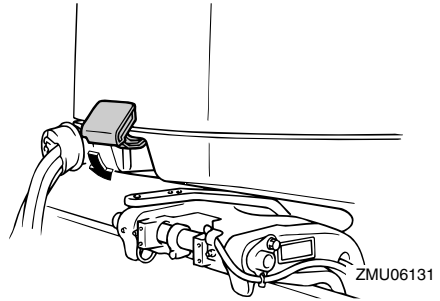

After installing, check the fitting of the top cowling by pushing it with both hands. If the top cowling is loose, have it repaired by your Yamaha dealer.

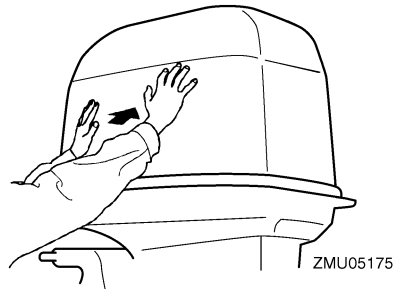

# Operation

EMU42560

## Checking power trim and tilt system

EWM01930

### **WARNING**

- Never get under the lower unit while it is tilted, even when the tilt support lever is locked. Severe injury could occur if the outboard motor accidentally falls.
- Body parts can be crushed between the motor and the clamp bracket when the motor is trimmed or tilted.
- Be sure no one is near the outboard motor before performing this check.

1. Check the power trim and tilt unit for any sign of oil leaks.
2. Operate each of the power trim and tilt switches on the remote control and engine bottom cowling to check that all switches work.
3. Tilt the outboard motor up and check that the tilt rod and trim rods are extended completely.

**F200C, FL200C, F225B, FL225B, F250A, FL250A**

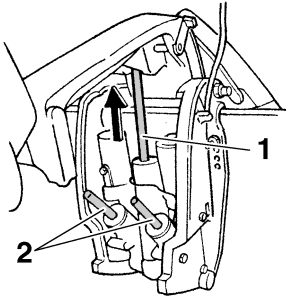

ZMU05471

1. Tilt rod
2. Trim rods

## F225C

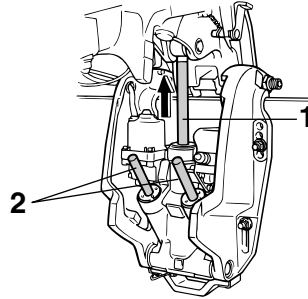

ZMU06016

1. Tilt rod
  2. Trim rods
4. Use the tilt support lever to lock the motor in the up position. Operate the tilt down switch briefly so the motor is supported by the tilt support lever.

**F200C, FL200C, F225B, FL225B, F250A, FL250A**

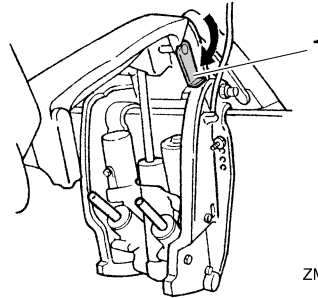

ZMU05472

1. Tilt support lever

## F225C

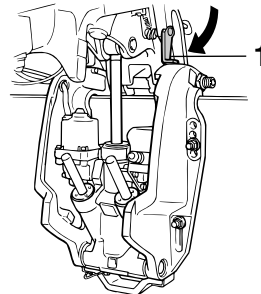

ZMU06017

1. Tilt support lever

5. Check that the tilt rod and trim rods are free of corrosion or other flaws.
6. Activate the tilt-down switch until the trim rods have retracted completely into the cylinders.

**F200C, FL200C, F225B, FL225B, F250A, FL250A**

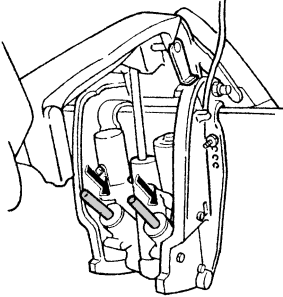

ZMU05473

**F225C**

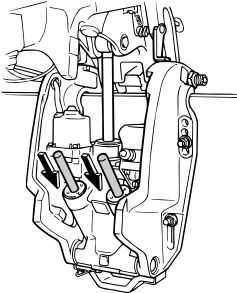

ZMU03452

7. Activate the trim-up switch until the tilt rod is fully extended. Unlock the tilt support lever.

**F200C, FL200C, F225B, FL225B, F250A, FL250A**

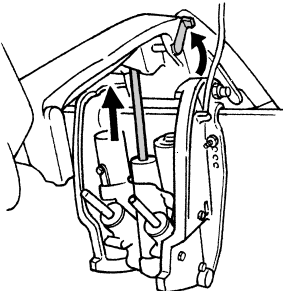

ZMU01885

**F225C**

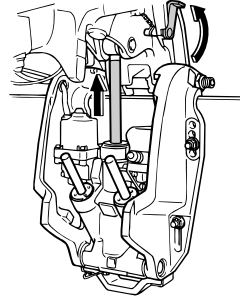

ZMU02635

8. Tilt the outboard motor down. Check that the tilt rod and trim rods operate smoothly.

EMU36582

## Battery

Check that the battery is in good condition, and fully charged. Check that the battery connections are clean, secure and covered by insulating covers. The electrical contacts of the battery and cables must be clean and properly connected or the battery will not start the engine.

Refer to the battery manufacturer's instructions for checks for your particular battery.

EMU30026

## Filling fuel

EWM01830

### **WARNING**

- Gasoline and its vapors are highly flammable and explosive. Always refuel according to this procedure to reduce the risk of fire and explosion.
- Gasoline is poisonous and can cause injury or death. Handle gasoline with care. Never siphon gasoline by mouth. If you should swallow some gasoline or inhale a lot of gasoline vapor, or get some gasoline in your eyes, see your doctor immediately. If gasoline spills on your

# Operation

skin, wash with soap and water. If gasoline spills on your clothing, change your clothes.

1. Make sure that the engine is stopped.
2. Make sure that the boat is in a well-ventilated outdoor area, either securely moored or trailered.
3. Make sure that no one is in the boat.
4. Do not smoke and keep away from sparks, flames, static electric discharge, or other sources of ignition.
5. If you use a portable container to store and dispense fuel, only use a locally approved GASOLINE container.
6. Touch the fuel nozzle to the filler opening or funnel to help prevent electrostatic sparks.
7. Fill the fuel tank, but do not overfill. **WARNING! Do not overfill. Otherwise fuel can expand and overflow if the temperature increases.** [EWM02610]
8. Tighten the fuel tank cap securely.
9. Wipe up any spilled gasoline immediately with dry rags. Dispose of rags properly according to local laws or regulations.

EMU27452

## Operating engine

EWM00420

### **WARNING**

- Before starting the engine, make sure that the boat is tightly moored and that you can steer clear of any obstructions. Be sure there are no swimmers in the water near you.
- When the air vent screw is loosened, gasoline vapor will be released. Gasoline is highly flammable, and its vapors are flammable and explosive. Refrain from smoking, and keep away from open flames and sparks while loosening the air vent screw.

- This product emits exhaust gases which contain carbon monoxide, a colorless, odorless gas which could cause brain damage or death when inhaled. Symptoms include nausea, dizziness, and drowsiness. Keep cockpit and cabin areas well ventilated. Avoid blocking exhaust outlets.

EMU31812

## Sending fuel

1. If there is a fuel joint or a fuel cock on the boat, firmly connect the fuel line to the joint or open the fuel cock.
2. Squeeze the primer pump, with the arrow pointing up, until you feel it become firm.

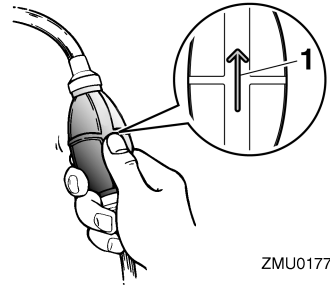

ZMU01770

1. Arrow

EMU27494

## Starting engine

EWM01600

### **WARNING**

Before starting the engine, make sure that the boat is tightly moored and that you can steer clear of any obstructions. Be sure there are no swimmers in the water near you.

EMU27629

## Electric start and remote control models

EWM01840

### **WARNING**

- Failure to attached engine shut-off cord could result in a runaway boat if operator is ejected. Attach the engine shut-off

cord to a secure place on your clothing, or your arm or leg while operating. Do not attach the cord to clothing that could tear loose. Do not route the cord where it could become entangled, preventing it from functioning.

- Avoid accidentally pulling the cord during normal operation. Loss of engine power means the loss of most steering control. Also, without engine power, the boat could slow rapidly. This could cause people and objects in the boat to be thrown forward.

1. Place the remote control lever in “N” (neutral).

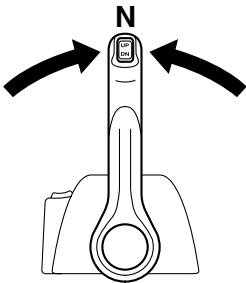

ZMU04588

**TIP:**

The start-in-gear protection device prevents the engine from starting except when in neutral.

2. Attach the engine shut-off cord to a secure place on your clothing, or your arm or leg. Then install the clip on the other end of the cord into the engine shut-off switch.

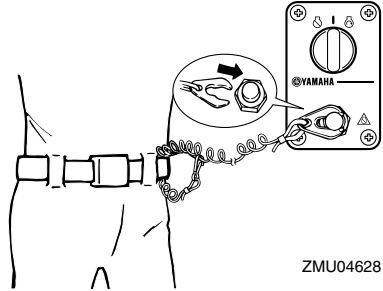

ZMU04628

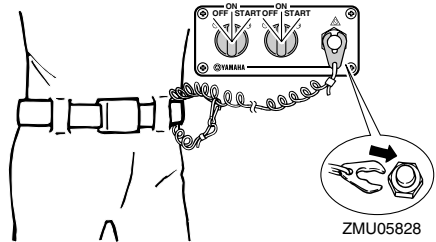

ZMU05828

3. Turn the main switch to “ON” (on).

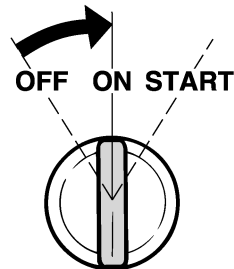

ZMU01773

**TIP:**

Dual engine users: When the main switch is turned on, the buzzer operates for a few seconds then stops automatically. The buzzer also operates if one of the engines stalls.

4. Turn the main switch to “START” (start), and hold it for a maximum of 5 seconds.

# Operation

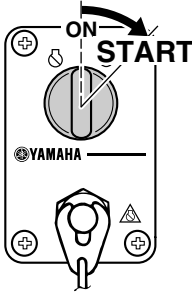

ZMU04596

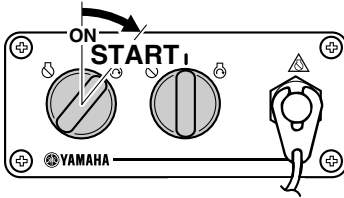

ZMU05830

5. Immediately after the engine starts, release the main switch to return it to "ON" (on). **NOTICE: Never turn the main switch to "START" (start) while the engine is running. Do not keep the starter motor turning for more than 5 seconds. If the starter motor is turned continuously for more than 5 seconds, the battery will be quickly discharged, thus making it impossible to start the engine. The starter can also be damaged. If the engine will not start after 5 seconds of cranking, return the main switch to "ON" (on), wait 10 seconds, then crank the engine again.**

[ECM00192]

EMU36510

## Checks after starting engine

EMU36523

### Cooling water

Check for a steady flow of water from the cooling water pilot hole. A continuous flow of water from the pilot hole indicates that the water pump is pumping water through the cooling water passages. If the cooling water passages are frozen, it may take a while for water to start flowing out of the pilot hole.

ECM01810

### NOTICE

**If water is not flowing out of the pilot hole at all times while the engine is running, overheating and serious damage could occur. Stop the engine and check whether the cooling water inlet on the lower case or the cooling water pilot hole is blocked. Consult your Yamaha dealer if the problem cannot be located and corrected.**

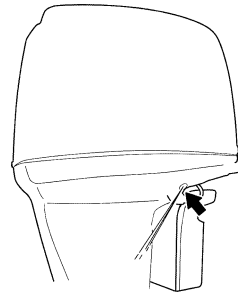

ZMU05169

EMU27670

## Warming up engine

EMU30037

### Electric start models

1. After starting the engine, allow it to idle for 3 minutes to warm up to provide maximum operating performance and acceleration. Failure to do so will shorten engine life.



- Be sure the low oil pressure-alert indicator remains off after starting the engine.  
**NOTICE:** If the low oil pressure-alert indicator blinks after the engine starts, stop the engine. Otherwise, serious engine damage could occur. Check the oil level and add engine oil if necessary. Consult your Yamaha dealer if the cause for the low oil pressure alert cannot be found. [ECM01831]

EMU36531

## Checks after engine warm up

EMU36541

### Shifting

While the boat is tightly moored, and without applying throttle, confirm that the engine shifts smoothly into forward and reverse, and back to neutral.

EMU31721

### Stop switches

- Confirm that turning the main switch to the "OFF" (off) position stops the engine.
- Confirm that removing the clip from the engine shut-off switch stops the engine.
- Confirm that the engine cannot be started with the clip removed from the engine shut-off switch.

EMU31733

## Shifting

EWM00180

### **WARNING**

Before shifting, make sure there are no swimmers or obstacles in the water near you.

ECM01610

### **NOTICE**

Warm up the engine before shifting into gear. Until the engine is warm, the idle speed may be higher than normal. High idle speed can prevent you from shifting

back to neutral. If this occurs, stop the engine, shift to neutral, then restart the engine and allow it to warm up.

### To shift out of neutral

- Pull the neutral interlock trigger up (if equipped).
- Move the remote control lever firmly and crisply forward (for forward gear) or rearward (for reverse gear) about 35° (a detent can be felt).

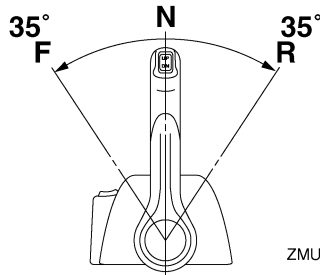

### To shift from in gear (forward/reverse) to neutral

- Close the throttle so that the engine slows to idle speed.

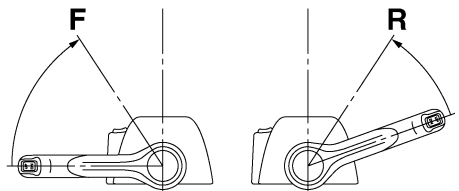

- After the engine is at idle speed in gear, move the remote control lever firmly and crisply to the neutral position.

# Operation

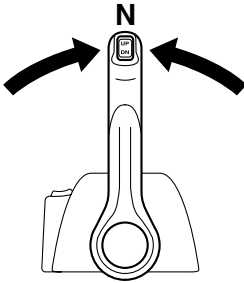

ZMU04588

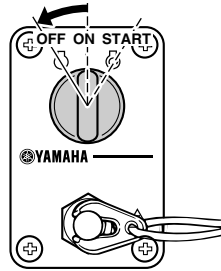

ZMU04599

EMU31742

## Stopping boat

EWMO1510

### WARNING

- Do not use the reverse function to slow down or stop the boat as it could cause you to lose control, be ejected, or impact the steering wheel or other parts of the boat. This could increase the risk of serious injury. It could also damage the shift mechanism.
- Do not shift into reverse while traveling at planing speeds. Loss of control, boat swamping, or damage to the boat could occur.

The boat is not equipped with a separate braking system. Water resistance stops it after the throttle lever is moved back to idle. The stopping distance varies depending on gross weight, water surface conditions, and wind direction.

EMU27821

## Stopping engine

Before stopping the engine, first let it cool off for a few minutes at idle or low speed. Stopping the engine immediately after operating at high speed is not recommended.

EMU31831

### Procedure

1. Turn the main switch to "OFF" (off).

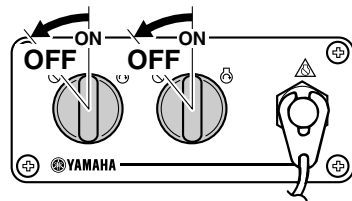

ZMU05833

2. Remove the key if the boat will be left unattended.

### TIP:

The engine can also be stopped by pulling the cord and removing the clip from the engine shut-off switch, then turning the main switch to "OFF" (off).

EMU27862

## Trimming outboard motor

EWMO0740

### WARNING

Excessive trim for the operating conditions (either trim up or trim down) can cause boat instability and can make steering the boat more difficult. This increases the possibility of an accident. If the boat begins to feel unstable or is hard to steer, slow down and/or readjust the trim angle.

The trim angle of the outboard motor helps determine the position of the bow of the boat in the water. Correct trim angle will help improve performance and fuel economy while reducing strain on the engine. Correct trim angle depends upon the combination of boat, engine, and propeller. Correct trim is also affected by variables such as the load in the boat, sea conditions, and running speed.

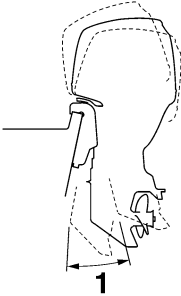

ZMU05170

1. Trim operating angle

EMU27888

## Adjusting trim angle (Power trim and tilt)

EWM00753

### **WARNING**

- Be sure all people are clear of the outboard motor when adjusting the trim angle. Body parts can be crushed between the motor and the clamp bracket when the motor is trimmed or tilted.
- Use caution when trying a trim position for the first time. Increase speed gradually and watch for any signs of instability or control problems. Improper trim angle can cause loss of control.
- If equipped with a power trim and tilt switch located on the bottom cowling, use the switch only when the boat is at a complete stop with the engine off. Do not adjust the trim angle with this switch while the boat is moving.

Adjust the outboard motor trim angle using the power trim and tilt switch.

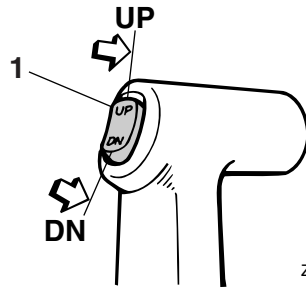

ZMU04193

1. Power trim and tilt switch

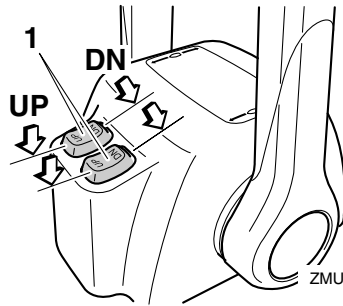

ZMU04601

1. Power trim and tilt switch

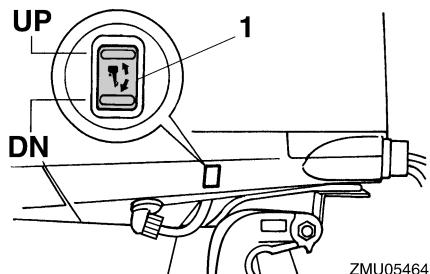

ZMU05464

1. Power trim and tilt switch

To raise the bow (trim-out), press the switch “UP” (up).

To lower the bow (trim-in), press the switch “DN” (down).

# Operation

Make test runs with the trim set to different angles to find the position that works best for your boat and operating conditions.

EMU27912

## Adjusting boat trim

When the boat is on plane, a bow-up attitude results in less drag, greater stability and efficiency. This is generally when the keel line of the boat is up about 3 to 5 degrees. With the bow up, the boat may have a greater tendency to steer to one side or the other. Compensate for this as you steer. When the bow of the boat is down, it is easier to accelerate from a standing start onto plane.

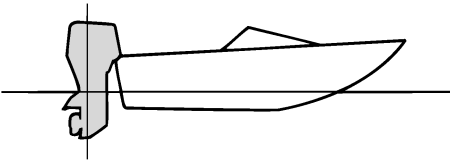

ZMU01784

## Bow Up

Too much trim-out puts the bow of the boat too high in the water. Performance and economy are decreased because the hull of the boat is pushing the water and there is more air drag. Excessive trim-out can also cause the propeller to ventilate, which reduces performance further, and the boat may “porpoise” (hop in the water), which could throw the operator and passengers overboard.

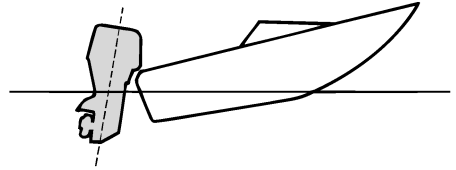

ZMU01785

## Bow Down

Too much trim-in causes the boat to “plow” through the water, decreasing fuel economy and making it hard to increase speed. Operating with excessive trim-in at higher speeds also makes the boat unstable. Resistance at the bow is greatly increased, heightening the danger of “bow steering” and making operation difficult and dangerous.

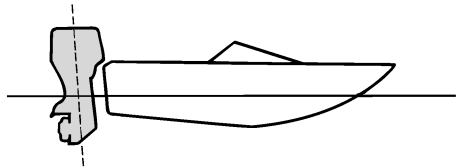

ZMU01786

## TIP:

Depending on the type of boat, the outboard motor trim angle may have little effect on the trim of the boat when operating.

EMU27946

## Tilting up and down

If the engine will be stopped for some time or if the boat is moored in shallows, the outboard motor should be tilted up to protect the propeller and lower case from damage by collision with obstructions, and also to reduce salt corrosion.

EWM01543

## **WARNING**

Make sure that all people are clear of the outboard motor when tilting the outboard motor up and down. Body parts can be crushed between the outboard motor and the clamp bracket when the outboard motor is trimmed or tilted.

ECM00991

## **NOTICE**

- Before tilting the outboard motor, follow the procedure under “Stopping engine” in this chapter. Never tilt the outboard motor while the engine is running. Severe damage from overheating can result.
- To prevent the cooling water passages from becoming frozen when the ambient temperature is 5°C or below, tilt the outboard motor up after it has been stopped 30 seconds or more.

EMU42681

## **Procedure for tilting up (power trim and tilt models)**

1. Place the remote control lever in neutral.

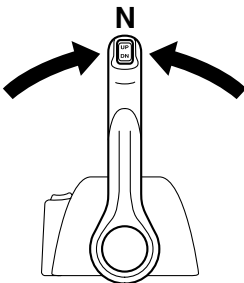

ZMU07396

2. Press the power trim and tilt switch “UP” (up) until the outboard motor has tilted up completely.

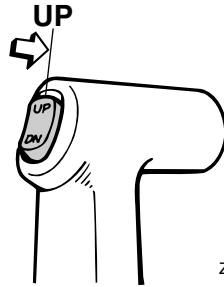

ZMU04194

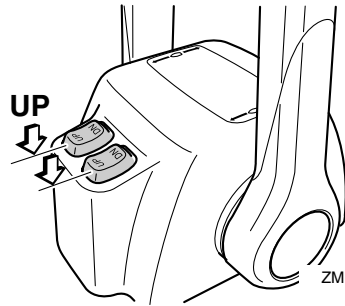

ZMU07398

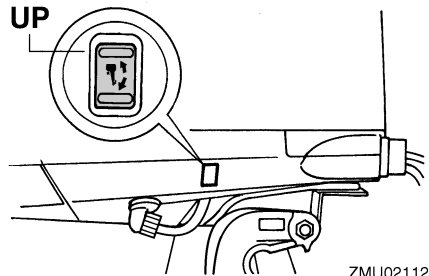

ZMU02112

3. Pull the tilt support lever toward you to support the engine. **WARNING!** After tilting the outboard motor, be sure to support it with the tilt support knob or tilt support lever. Otherwise the outboard motor could fall back down suddenly if oil in the power trim and tilt unit or in the power tilt unit loses pressure. [EWM00262] **NOTICE:** Do not use the tilt support lever or knob when trailering the boat. The outboard motor

# Operation

could shake loose from the tilt support and fall. If the motor cannot be trailered in the normal running position, use an additional support device to secure it in the tilt position. For more detailed information, see page 58.

[ECM01641]

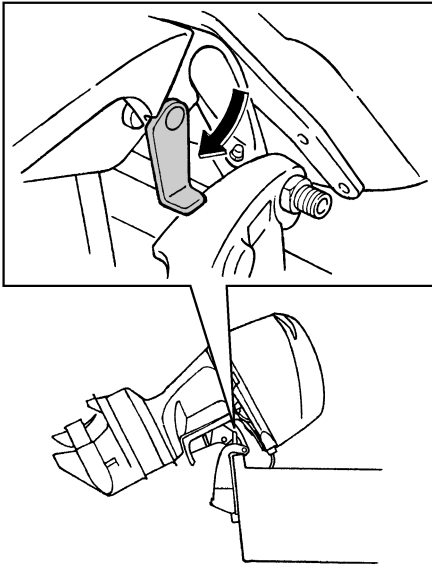

ZMU05352

4. Once the outboard motor is supported with the tilt support lever, press the power trim and tilt switch “DN” (down) to retract the trim rods. **NOTICE: Make sure that the trim rods retract completely during mooring. This protects the rods from marine growth and corrosion, which could damage the power trim and tilt mechanism.** [ECM00252]

F200C, FL200C, F225B, FL225B, F250A, FL250A

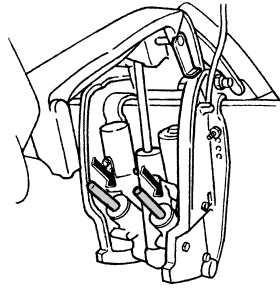

ZMU07399

F225C

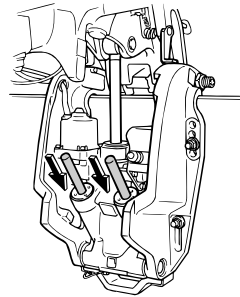

ZMU07397

EMU42700

## Procedure for tilting down (power trim and tilt models)

1. Push the power trim and tilt switch “UP” (up) until the outboard motor is supported by the tilt rod and the tilt support lever becomes free.
2. Release the tilt support lever.

F200C, FL200C, F225B, FL225B, F250A, FL250A

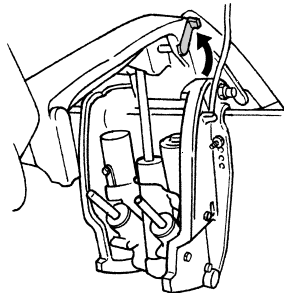

ZMU07546

## F225C

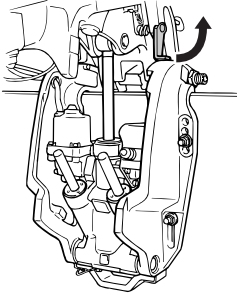

ZMU06018

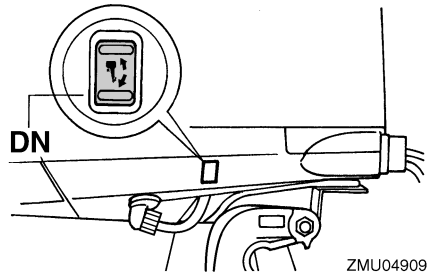

ZMU04909

3. Push the power trim and tilt switch “DN” (down) to lower the outboard motor to the desired position.

EMU28062

## Shallow water

EMU32871

### Power trim and tilt models

The outboard motor can be tilted up partially to allow operation in shallow water.

ECM01490

### **NOTICE**

- If the engine speed is suddenly increased when the outboard motor is partially tilted up, the power trim and tilt unit could be damaged.
- Do not tilt the outboard motor up so that the cooling water inlet on the lower unit is above the surface of the water when setting up for and cruising in shallow water. Otherwise severe damage from overheating can result.

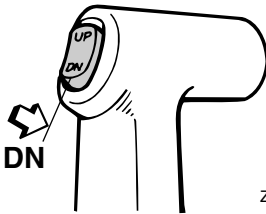

ZMU04196

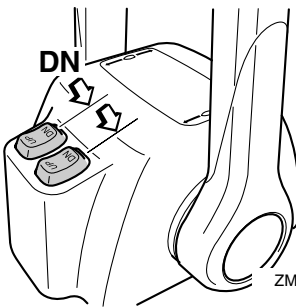

ZMU04603

EMU32922

### Procedure for power trim and tilt models

1. Place the remote control lever in neutral.

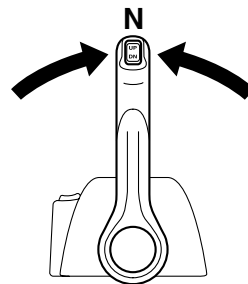

ZMU04588

# Operation

---

2. Slightly tilt the outboard motor up to the desired position using the power trim and tilt switch. **WARNING! Using the power trim and tilt switch on the bottom cowling while the boat is moving or engine is on could increase the risk of falling overboard and could distract the operator, increasing the risk of collision with another boat or an obstacle.** [EWM01850]

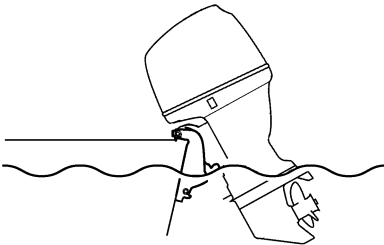

ZMU05173

3. To return the outboard motor to the normal running position, press the power trim and tilt switch and slowly tilt the outboard motor down.

EMU28195

## Cruising in other conditions

### Cruising in salt water

After operating in salt water, flush the cooling water passages with fresh water to prevent them from becoming clogged. Also rinse the outside of the outboard motor with fresh water.

### Cruising in muddy, turbid, or acidic water

Yamaha strongly recommends that you use the optional chromium-plated water pump kit (see page 14) if you use the outboard motor in acidic water or water with a lot of sediment in it, such as muddy or turbid (cloudy) water. After operating in such water, flush the cooling passages with fresh water to prevent corrosion. Also rinse the outside of the outboard motor with fresh water.



EMU31844

## Transporting and storing outboard motor

EWM02640

### **WARNING**

- **USE CARE** when transporting fuel tank, whether in a boat or car.
- **DO NOT** fill fuel container to maximum capacity. Gasoline will expand considerably as it warms up and can build up pressure in the fuel container. This can cause fuel leakage and a potential fire hazard.
- **Leaking fuel is a fire hazard.** Tighten securely the fuel valve when transporting and storing the outboard motor.
- **Never get under the outboard motor while it is tilted.** Severe injury could occur if the outboard motor accidentally falls.
- **Do not use the tilt support lever or knob when trailering the boat.** The outboard motor could shake loose from the tilt support and fall. If the outboard motor cannot be trailered in the normal running position, use an additional support device to secure it in the tilt position.

ECM02440

### **NOTICE**

When storing the outboard motor for prolonged time, fuel must be drained from the fuel tank. The deteriorated fuel could clog the fuel line causing engine start difficulty or malfunction.

Leaking fuel is a fire hazard. When trailering the boat, close the fuel valve to prevent fuel from leaking.

The outboard motor should be transported and stored in the normal running position. If there is insufficient road clearance in this po-

sition, then trailer the outboard motor in the tilt position using a motor support device such as a transom saver bar. Consult your Yamaha dealer for further details.

When the outboard motor is tilted prolonged time for mooring or trailering the boat, close the fuel valve.

EMU30041

### **Storing outboard motor**

When storing your Yamaha outboard motor for prolonged periods of time (2 months or longer), several important procedures must be performed to prevent excessive damage. It is advisable to have your outboard motor serviced by an authorized Yamaha dealer prior to storage. However, you, the owner, with a minimum of tools, can perform the following procedures.

ECM01350

### **NOTICE**

- **To prevent problems which can be caused by oil entering the cylinder from the sump, keep the outboard motor in the attitude shown when transporting and storing it.** Do not store or transport the outboard motor on its side (not upright).
- **Do not place the outboard motor on its side before the cooling water has drained from it completely, otherwise water may enter the cylinder through the exhaust port and cause engine trouble.**
- **Store the outboard motor in a dry, well-ventilated place, not in direct sunlight.**
- **Drain the remaining gasoline from the vapor separator. Gasoline left in the vapor separator for a prolonged period of time will break down and could cause damage to the fuel line.**

# Maintenance

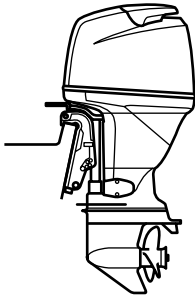

ZMU04261

EMU28305

## Procedure

EMU31375

### Flushing with a flushing attachment (F200C, FL200C, F225B, FL225B)

EWM00322

#### **WARNING**

You could be seriously injured if the engine accidentally starts when you are near the propeller.

- Before inspecting, removing, or installing the propeller, remove the ignition coils from the spark plugs. Also, place the shift control in neutral, turn the main switch to “OFF” (off) and remove the key, and remove the clip from the engine shut-off switch. Turn off the battery cut-off switch if your boat has one.
- Do not use your hand to hold the propeller when loosening or tightening the propeller nut. Put a wood block between the anti-cavitation plate and the propeller to prevent the propeller from turning.

#### TIP:

This procedure is performed while the top cowling and propeller are removed.

1. Disconnect the fuel line from the motor.
2. Install the flushing attachment over the cooling water inlet. **NOTICE: Do not run the engine without supplying it with cooling water. Either the engine water**

pump will be damaged or the engine will be damaged from overheating. Before starting the engine, be sure to supply water to the cooling water passages. Avoid running the outboard motor at high speed while on the flushing attachment, otherwise overheating could occur. [ECM02000]

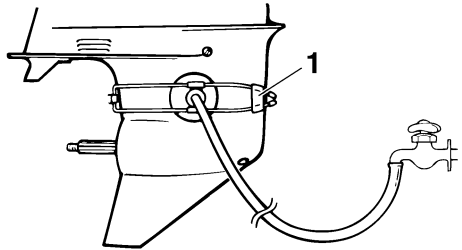

ZMU01830

1. Flushing attachment
3. Cooling system flushing is essential to prevent the cooling system from clogging up with salt, sand, or dirt. In addition, fogging/lubricating the engine is necessary to prevent excessive engine damage due to rust. Perform the flushing and fogging at the same time. **WARNING! Do not touch or remove electrical parts when starting or during operation. Keep hands, hair, and clothes away from the flywheel and other rotating parts while the engine is running.** [EWM00091]

#### TIP:

- When using the flushing attachment, maintain adequate water pressure so that there is a steady flow of water from the cooling water pilot hole.
- A flushing attachment is available from your Yamaha dealer.
- If the overheat alert device is activated, turn the engine off, and consult your Yamaha dealer.

- Run the engine at a fast idle for a few minutes in neutral position. **WARNING! Attach the engine shut-off cord to a secure place on your clothing, or your arm or leg while operating. Do not attach the cord to clothing that could tear loose. Do not route the cord where it could become entangled, preventing it from functioning.** [EWM01472]  
**NOTICE:** Never turn the main switch to "START" (start) while the engine is running. Do not keep the starter motor turning for more than 5 seconds. If the starter motor is turned continuously for more than 5 seconds, the battery will be quickly discharged, thus making it impossible to start the engine. The starter can also be damaged. If the engine will not start after 5 seconds of cranking, return the main switch to "ON" (on), wait 10 seconds, then crank the engine again. [ECM00192]
- Just prior to turning off the engine, quickly spray "Fogging Oil" alternately into the intake silencer or the fogging hole of the silencer cover, if equipped. When properly done, the engine will smoke excessively and almost stall.

## TIP:

If "Fogging Oil" is not available, turn off the engine. Remove the spark plug(s). Pour a teaspoonful of clean engine oil into each cylinder. Crank the engine several times manually. Reinstall the spark plug(s).

- Remove the flushing attachment.

EMU41320

## Draining the gasoline from the vapor separator

Gasoline in the vapor separator must be drained before storing the outboard motor. Have a Yamaha dealer drain the gasoline from the vapor separator.

EMU31393

## Washing the outboard motor

### TIP:

This procedure is performed while the top cowling is installed.

- Wash the outboard motor body using fresh water. **NOTICE: Do not spray water into the air intake.** [ECM01840]

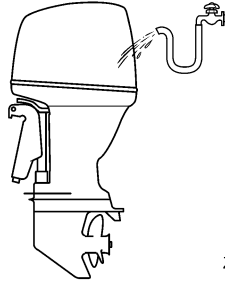

ZMU05174

- Drain the cooling water completely out of the motor. Clean the body thoroughly.

EMU28402

## Lubrication

- Install the spark plug(s) and torque to proper specification. For information on spark plug installation, see page 68.
- Change the gear oil. For instructions, see page 74. Inspect the oil for the presence of water that indicates a leaky seal. Seal replacement should be performed by an authorized Yamaha dealer prior to use.
- Grease all grease fittings. For further details, see page 66.

### TIP:

For long-term storage, fogging the engine with oil is recommended. Contact your Yamaha dealer for information about fogging oil and procedures for your engine.

EMU42550

## Flushing power unit

Perform this procedure right after operation for the most thorough flushing.

# Maintenance

ECM01530

## NOTICE

**Do not perform this procedure while the engine is running. The water pump may be damaged and severe damage from overheating can result.**

1. After shutting off the engine, unscrew the garden hose connector from the fitting on the bottom cowling.

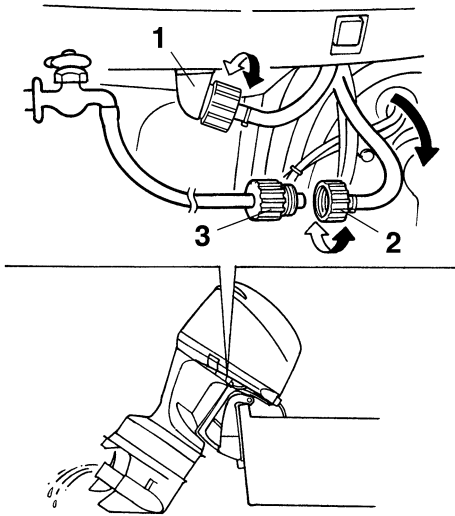

ZMU02136

1. Fitting
  2. Garden hose connector
  3. Garden hose adapter
2. Screw the garden hose adapter onto a garden hose, which is connected to a fresh water supply, and then connect it to the garden hose connector.
  3. With the engine off, turn on the water tap and let the water flush through the cooling passages for about 15 minutes. Turn

off the water and disconnect the garden hose adapter from the garden hose connector.

4. Reinstall the garden hose connector onto the fitting on the bottom cowling. Tighten the connector securely. **NOTICE: Do not leave the garden hose connector loose on the bottom cowling fitting or let the hose hang free during normal operation. Water will leak out of the connector instead of cooling the engine, which can cause serious overheating. Be sure the connector is tightened securely on the fitting after flushing the engine.** [ECM00541]

## TIP:

- When flushing the engine with the boat in the water, tilting up the outboard motor until it is completely out of the water will achieve better results.
- F200C, FL200C, F225B, FL225B: For cooling system flushing instructions, see page 58.

EMU28452

## Cleaning the outboard motor

After use, wash the exterior of the outboard motor with fresh water. Flush the cooling system with fresh water.

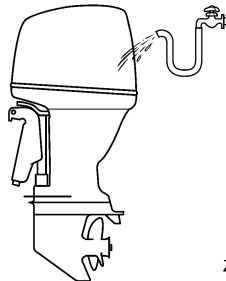

ZMU05174

EMU28461

## Checking painted surface of outboard motor

Check the outboard motor for scratches, nicks, or flaking paint. Areas with damaged paint are more likely to corrode. If necessary, clean and paint the areas. A touch-up paint is available from your Yamaha dealer.

EMU2847C

## Periodic maintenance

EWM01871



**These procedures require mechanical skills, tools, and supplies. If you do not have the proper skills, tools, or supplies to perform a maintenance procedure, have a Yamaha dealer or other qualified mechanic do the work.**

**The procedures involve disassembling the motor and exposing dangerous parts. To reduce the risk of injury from moving, hot, or electrical parts:**

- Turn off the engine and keep the key(s) and engine shut-off cord (lanyard) with you when you perform maintenance unless otherwise specified.
  - The power trim and tilt switches operate even when the ignition key is off. Keep people away from the switches whenever working around the motor. When the motor is tilted, keep away from the area under it or between it and the clamp bracket. Be sure no one is in this area before operating the power trim and tilt mechanism.
  - Allow the engine to cool before handling hot parts or fluids.
  - Always completely reassemble the motor before operation.
- 

EMU28511

## Replacement parts

If replacement parts are necessary, use only genuine Yamaha parts or parts of equivalent design and quality. Any part of inferior quality may malfunction, and the resulting loss of control could endanger the operator and passengers. Yamaha genuine parts and accessories are available from your Yamaha dealer.

EMU34151

## Severe operating conditions

Severe operating conditions involve one or more of the following types of operation on a regular basis:

- Operating continuously at or near maximum engine speed (rpm) for many hours
- Operating continuously at a low engine speed (rpm) for many hours
- Operating without sufficient time for engine to warm up and cool down
- Frequent quick acceleration and deceleration
- Frequent shifting
- Frequently starting and stopping the engine(s)
- Operation that fluctuates often between light and heavy cargo loads

Outboard motors operating under any of these above conditions require more frequent maintenance. Yamaha recommends that you do this service twice as often as specified in the maintenance chart. For example, if a particular service should be done at 50 hours, do it instead at 25 hours. This will help prevent more rapid deterioration of engine components.

# Maintenance

EMU34446

## Maintenance chart 1

### TIP:

- Refer to the sections in this chapter for explanations of each owner-specific action.
- The maintenance cycle on these charts assume usage of 100 hours per year and regular flushing of the cooling water passages. Maintenance frequency should be adjusted when operating the engine under adverse conditions such as extended trolling.
- Disassembly or repairs may be necessary depending on the outcome of maintenance checks.
- Expendable or consumable parts and lubricants will lose their effectiveness over time and through normal usage regardless of the warranty period.
- When operating in salt water, muddy, other turbid (cloudy), acidic water, the engine should be flushed with clean water after each use.

The “●” symbol indicates the check-ups which you may carry out yourself.

The “○” symbol indicates work to be carried out by your Yamaha dealer.

Item	Actions	Initial	Every			
		20 hours (3 months)	100 hours (1 year)	300 hours (3 years)	500 hours (5 years)	
Anode(s) (external)	Inspection or replacement as necessary		●/○			
Anode(s) (cylinder head, thermostat cover)	Inspection or replacement as necessary		○			
Anodes (exhaust cover, cooling water passage cover, Rectifier Regulator cover)	Replacement					○
Battery (electrolyte level, terminal)	Inspection	●/○	●/○			
Battery (electrolyte level, terminal)	Fill, charging or replacing as necessary		○			
Cooling water leakage	Inspection or replacement as necessary	○	○			
Cowling lock lever	Inspection		●/○			
Engine starting condition/noise	Inspection	●/○	●/○			
Engine idle speed/noise	Inspection	●/○	●/○			
Engine oil	Replacement	●/○	●/○			
Engine oil filter (cartridge)	Replacement		●/○			
Fuel filter (can be disassembled)	Inspection or replacement as necessary	●/○	●/○			

# Maintenance

Item	Actions	Initial	Every			
		20 hours (3 months)	100 hours (1 year)	300 hours (3 years)	500 hours (5 years)	
Fuel line (High pressure)	Inspection	●	●			
Fuel line (High pressure)	Inspection or replacement as necessary	○	○			
Fuel line (Low pressure)	Inspection	●	●			
Fuel line (Low pressure)	Inspection or replacement as necessary	○	○			
Fuel pump	Inspection or replacement as necessary			○		
Fuel/engine oil leakage	Inspection	○	○			
Gear oil	Replacement	●/○	●/○			
Greasing points	Greasing	●/○	●/○			
Impeller/water pump housing	Inspection or replacement as necessary		○			
Impeller/water pump housing	Replacement			○		
OCV (Oil Control Valve) filter	Replacement				○	
Power trim and tilt unit	Inspection	●/○	●/○			
Propeller/propeller nut/cotter pin	Inspection or replacement as necessary	●/○	●/○			
PCV (Pressure Control Valve)	Inspection or replacement as necessary		○			
Shift link/shift cable	Inspection, adjustment or replacement as necessary	○	○			
Spark plug(s)	Inspection or replacement as necessary		●/○			
Spark plug caps/spark plug wires	Inspection or replacement as necessary	○	○			
Water from the cooling water pilot hole	Inspection	●/○	●/○			
Throttle link/throttle cable/throttle pick-up timing	Inspection, adjustment or replacement as necessary	○	○			
Thermostat	Inspection or replacement as necessary		○			
Timing belt	Inspection or replacement as necessary		○			

# Maintenance

Item	Actions	Initial	Every		
		20 hours (3 months)	100 hours (1 year)	300 hours (3 years)	500 hours (5 years)
Valve clearance	Inspection and adjustment				○
Cooling water inlet	Inspection	●/○	●/○		
Main switch/stop switch/choke switch	Inspection or replacement as necessary	○	○		
Wire harness connections/wire coupler connections	Inspection or replacement as necessary	○	○		
(Yamaha) Meter/gauge	Inspection	○	○		

EMU34451

## Maintenance chart 2

Item	Actions	Every
		1000 hours
Exhaust guide/exhaust manifold	Inspection or replacement as necessary	○
Timing belt	Replacement	○

EMU28911

### TIP:

When using lead or high-sulfur gasoline, inspecting valve clearance may be required more frequently than every 500 hours.



EMU28943

## Greasing

Yamaha grease A (water resistant grease)

Yamaha grease D (corrosion resistant grease; for propeller shaft)

**F200C, FL200C, F225B, FL225B**

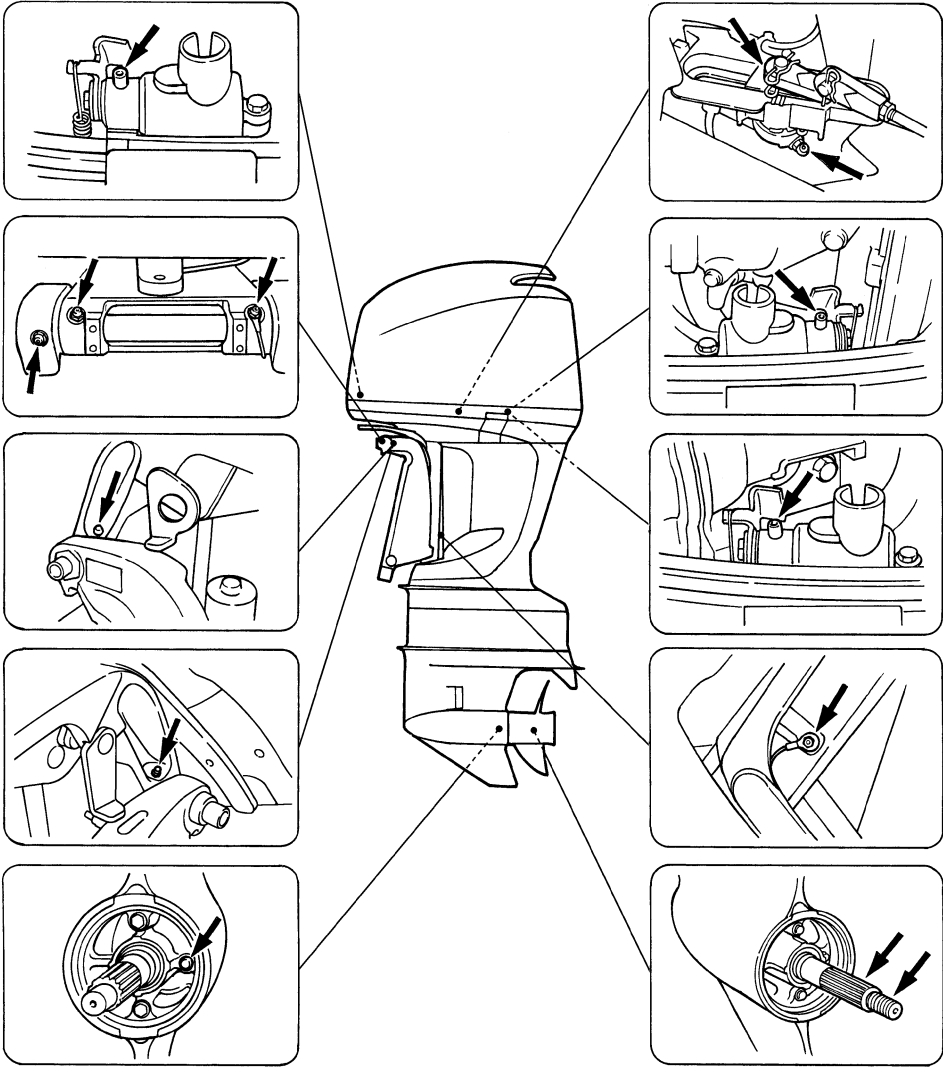

ZMU02138

# Maintenance

F225C, F250A, FL250A

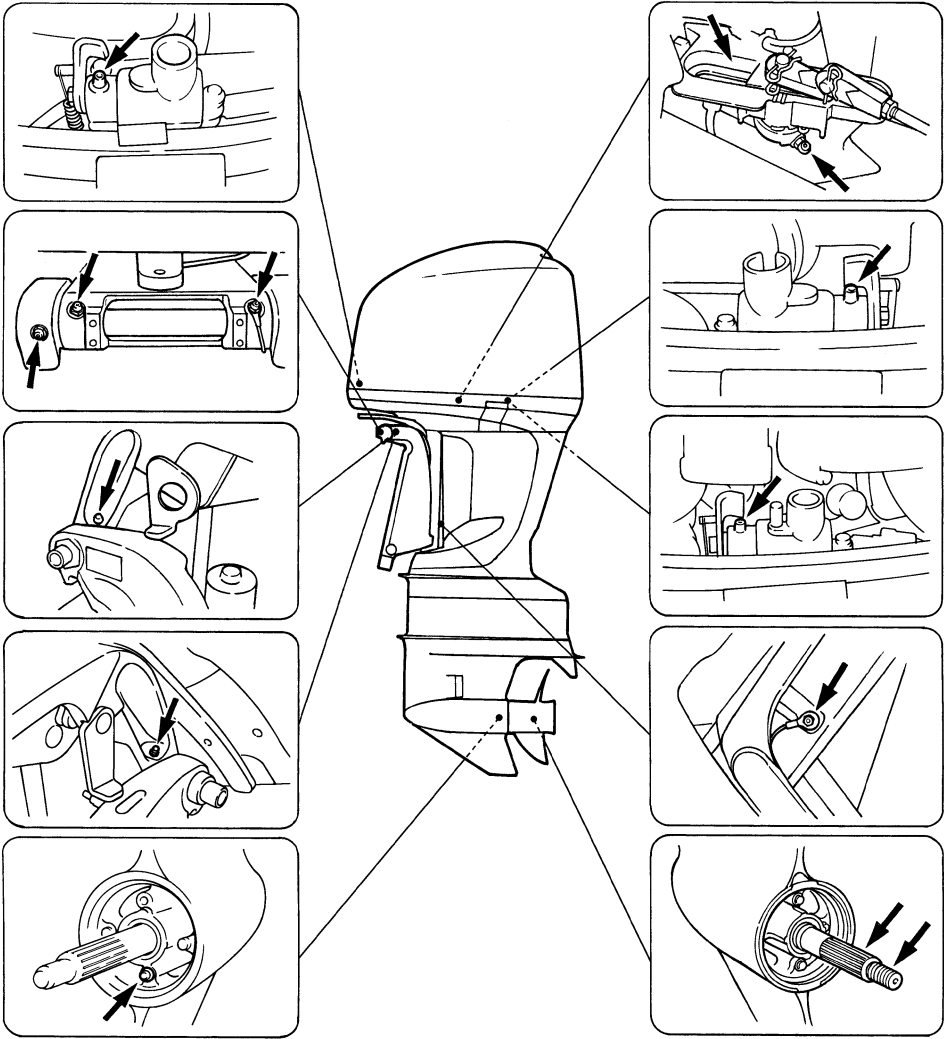

ZMU05149

EMU30778

## Cleaning and adjusting spark plug

The spark plug is an important engine component and is easy to inspect. The condition of the spark plug can indicate something about the condition of the engine. For example, if the center electrode porcelain is very white, this could indicate an intake air leak or carburetion problem in that cylinder. Do not attempt to diagnose any problems yourself. Instead, take the outboard motor to a Yamaha dealer. You should periodically remove and inspect the spark plug because heat and deposits will cause the spark plug to slowly break down and erode.

1. Remove the bolts to remove the ECM (Electronic control module) cover.

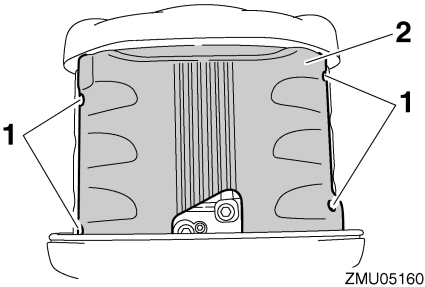

1. Bolts
  2. ECM (Electronic Control Module) cover
2. Remove the bolts that are securing the ignition coil, and then remove the ignition coil. Do not use any tools to remove or install the ignition coil, otherwise the ignition coil coupler may get damaged.

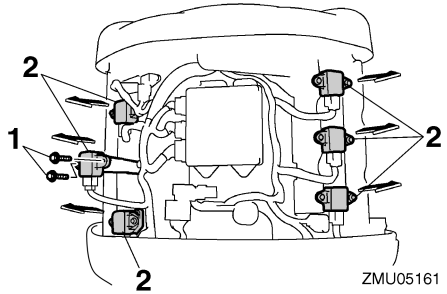

1. Bolts
  2. Ignition coil
3. Remove the spark plug. If electrode erosion becomes excessive, or if carbon and other deposits are excessive, you should replace the spark plug with another of the correct type. **WARNING! When removing or installing a spark plug, be careful not to damage the insulator. A damaged insulator could allow external sparks, which could lead to explosion or fire.** [EWM00561]

Standard spark plug:  
LFR6A-11

4. Be sure to use the specified spark plug, otherwise the engine may not operate properly. Before fitting the spark plug, measure the electrode gap with a wire thickness gauge; replace it if out of specification.

# Maintenance

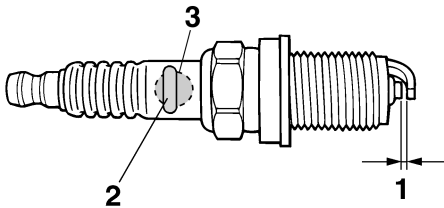

ZMU01797

1. Spark plug gap
2. Spark plug part number
3. Spark plug I.D. mark (NGK)

Spark plug gap:  
1.0–1.1 mm (0.039–0.043 in)

5. When fitting the plug, wipe off any dirt from the threads, and then screw it in to the correct torque.

Spark plug torque:  
25.0 Nm (2.55 kgf-m, 18.4 ft-lb)

## TIP:

If a torque-wrench is not available when you are fitting a spark plug, a good estimate of the correct torque is 1/4 to 1/2 turn past finger-tight. Have the spark plug adjusted to the correct torque as soon as possible with a torque-wrench.

6. Install the ignition coil and tighten the bolts.

Bolt tightening torque:  
7.0 Nm (0.71 kgf-m, 5.2 ft-lb)

7. Install the ECM (Electronic control module) cover and tighten the bolts.

Bolt tightening torque:  
8.0 Nm (0.82 kgf-m, 5.9 ft-lb)

EMU29044

## Inspecting idle speed

EWM00451

### **WARNING**

- Do not touch or remove electrical parts when starting or during operation.
- Keep hands, hair, and clothes away from the flywheel and other rotating parts while the engine is running.

ECM00490

### **NOTICE**

This procedure must be performed while the outboard motor is in the water. A flushing attachment or test tank can be used.

If the boat is not equipped with a tachometer for the outboard motor, use a diagnostic tachometer for this procedure. Results may vary depending on whether testing is conducted with the flushing attachment, in a test tank, or with the outboard motor in the water.

1. Start the engine and allow it to warm up fully in neutral until it is running smoothly.
2. Once the engine has warmed up, verify whether the idle speed is set to specification. For idle speed specifications, see page 9. If you have difficulty verifying the idle speed, or the idle speed requires adjustment, consult a Yamaha dealer or other qualified mechanic.

EMU37494

## Changing engine oil

ECM01710

### **NOTICE**

Change the engine oil after the first 20 hours of operation or 3 months, and every 100 hours or at 1-year intervals thereafter. Otherwise the engine will wear quickly.

The engine oil should be extracted with an oil changer.

# Maintenance

1. Put the outboard motor in an upright position (not tilted). **NOTICE: If the outboard motor is not level, the oil level indicated on the oil dipstick may not be accurate.** [ECM01861]

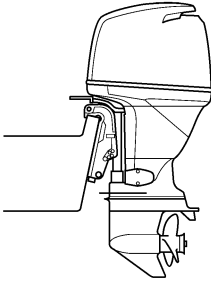

ZMU02141

2. Start the engine. Warm it up and keep the idle speed for 5-10 minutes.
3. Stop the engine and leave it for 5-10 minutes.
4. Remove the top cowling.
5. Remove the oil filler cap. Pull out the dipstick and use the oil changer to extract the oil completely.

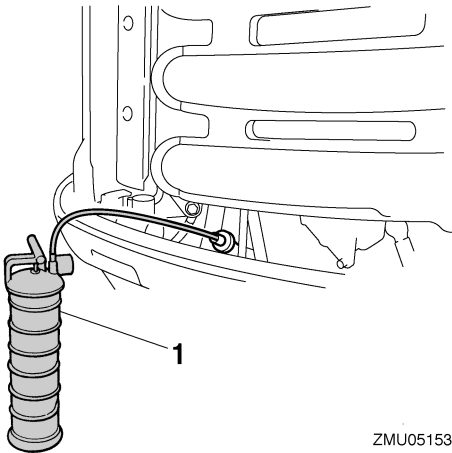

ZMU05153

1. Oil changer

6. Add the correct amount of oil through the filler hole. Put back the filler cap and the dipstick. **NOTICE: Overfilling the oil could cause leakage or damage. If the oil level is above the upper level mark, drain until the level meets the specified capacity.** [ECM01850]

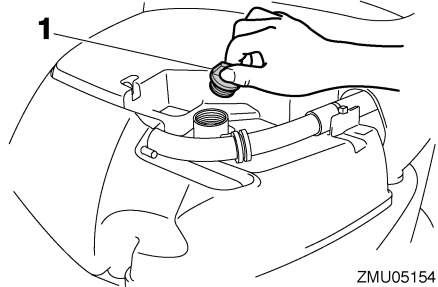

ZMU05154

1. Oil filler cap

Recommended engine oil:  
4-stroke outboard motor oil  
Replacement engine oil quantity (at periodic maintenance):  
Without oil filter replacement:  
4.5 L (4.76 US qt, 3.96 Imp.qt)  
With oil filter replacement:  
4.7 L (4.97 US qt, 4.14 Imp.qt)

7. Leave the outboard motor for 5-10 minutes.
8. Remove oil dipstick and wipe it clean.
9. Insert the dipstick and remove it again. Be sure to completely insert the dipstick into the dipstick guide, otherwise the oil level measurement will be incorrect.
10. Recheck the oil level using the dipstick to be sure the level falls between the upper and lower marks. Consult your Yamaha dealer if the oil level is out of specified level.

# Maintenance

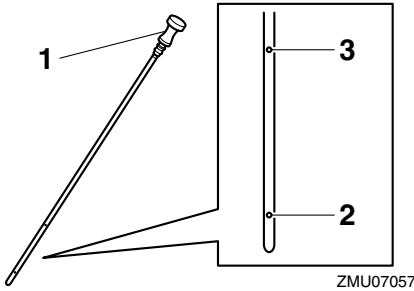

1. Oil dipstick
2. Lower level mark
3. Upper level mark

11. Start the engine and make sure that the low oil pressure-alert indicator remains off. Also, make sure that there are no oil leaks. **NOTICE: If the low oil pressure-alert indicator comes on or if there are oil leaks, stop the engine and find the cause. Continued operation with a problem could cause severe engine damage. Consult your Yamaha dealer if the problem cannot be located and corrected.** [ECM01622]
12. Dispose of used oil according to local regulations.

## TIP:

- For more information on the disposal of used oil, consult your Yamaha dealer.
- Change the oil more often when operating the engine under adverse conditions such as extended trolling.

EMU29114

## Inspecting wiring and connectors

- Inspect that each connector is engaged securely.
- Inspect that each ground lead is properly secured.

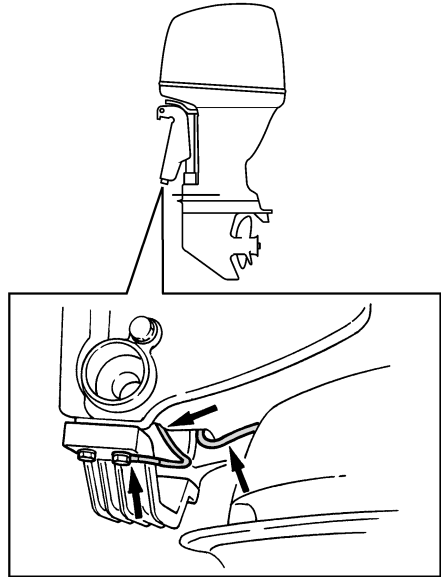

EMU29174

## Checking propeller

EWMO1881

### **WARNING**

You could be seriously injured if the engine accidentally starts when you are near the propeller. Before inspecting, removing, or installing the propeller, place the shift control in neutral, turn the main switch to “OFF” (off) and remove the key, and remove the clip from the engine shut-off switch. Turn off the battery cut-off switch if your boat has one.

Do not use your hand to hold the propeller when loosening or tightening the propeller nut. Put a wood block between the anti-cavitation plate and the propeller to prevent the propeller from turning.

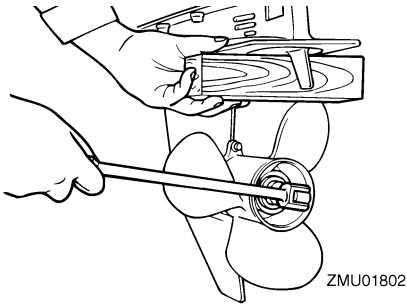

## Checkpoints

- Check each of the propeller blades for erosion from cavitation or ventilation, or other damage.
- Check the propeller shaft for damage.
- Check the splines for wear or damage.
- Check for fish line tangled around the propeller shaft.

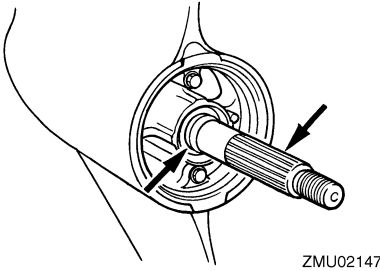

- Check the propeller shaft oil seal for damage.

EMU42631

## Removing propeller

1. Straighten the cotter pin and pull it out using a pair of pliers.
2. Remove the propeller nut, washer, and spacer. **WARNING! Do not use your hand to hold the propeller when loosening the propeller nut.** [EWM01890]

## F200C, FL200C, F225B, FL225B, F250A, FL250A

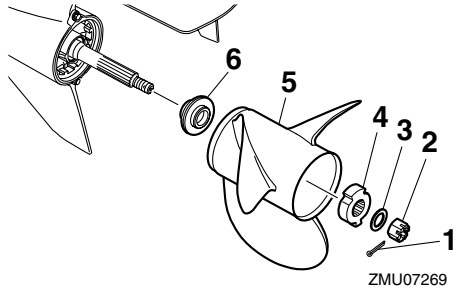

1. Cotter pin
2. Propeller nut
3. Washer
4. Spacer
5. Propeller
6. Thrust washer

## F225C

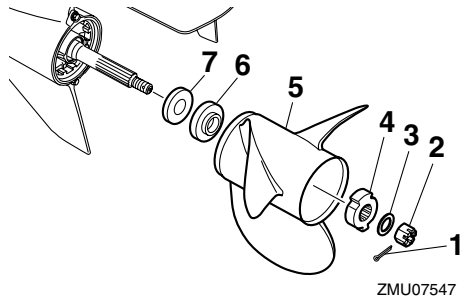

1. Cotter pin
  2. Propeller nut
  3. Washer
  4. Spacer
  5. Propeller
  6. Spacer
  7. Thrust washer
3. Remove the propeller, spacer (if equipped), and thrust washer.

# Maintenance

EMU42642

## Installing propeller

EWM00770

### **WARNING**

On counter rotation models, be sure to use a propeller intended for counterclockwise rotation. These propellers are identified with the letter "L" after the size indication on the propeller. Otherwise the boat could move in the opposite direction from that expected.

ECM00501

### **NOTICE**

Make sure to use a new cotter pin and bend the ends over securely. Otherwise, the propeller could come off during operation and be lost.

1. Apply Yamaha marine grease or a corrosion resistant grease to the propeller shaft.
2. Install the thrust washer, spacer (if equipped), and propeller on the propeller shaft. **NOTICE: Make sure to install the thrust washer before installing the propeller. Otherwise, the lower case and propeller boss could be damaged.**

[ECM01881]

3. Install the spacer, washer, and propeller nut. Tighten the propeller nut to the specified torque.

## F200C, FL200C, F225B, FL225B, F250A, FL250A

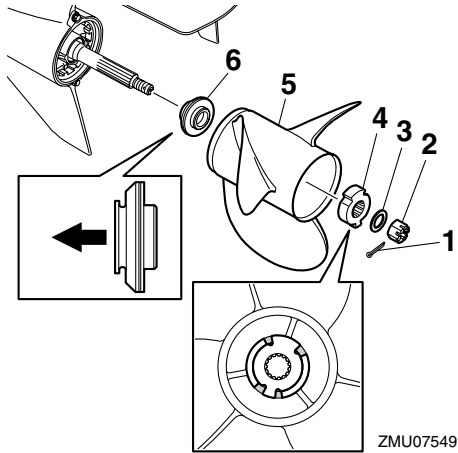

1. Cotter pin
2. Propeller nut
3. Washer
4. Spacer
5. Propeller
6. Thrust washer

## F225C

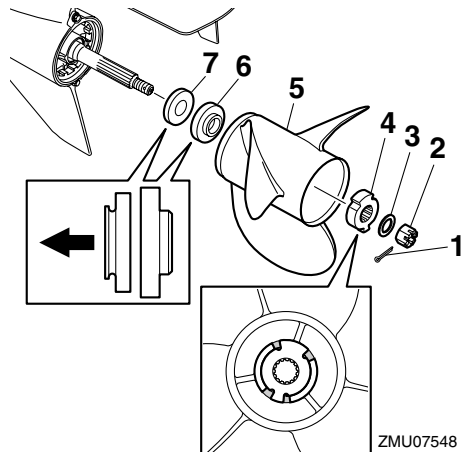

1. Cotter pin
2. Propeller nut
3. Washer
4. Spacer
5. Propeller



6. Spacer
7. Thrust washer

Propeller nut tightening torque:  
55.0 Nm (5.61 kgf-m, 40.6 ft-lb)

## TIP:

Make sure to align the protrusions on the spacer with the cutout areas of the propeller.

4. Align the propeller nut slot with the propeller shaft hole. Insert a new cotter pin in the hole and bend the cotter pin ends.  
**NOTICE: Do not reuse the cotter pin. Otherwise, the propeller can come off during operation.** [ECM01891]

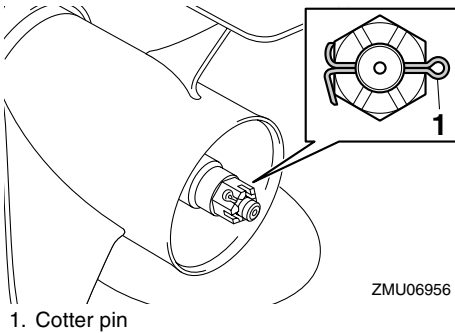

## TIP:

If the propeller nut slot does not align with the propeller shaft hole after tightening the propeller nut to the specified torque, tighten the nut further to align the slot with the hole.

EMU42570

## Changing gear oil

F200C, FL200C, F225B, FL225B

EWM00800

## WARNING

- Be sure the outboard motor is securely fastened to the transom or a stable stand. You could be severely injured if the outboard motor falls on you.

- Never get under the lower unit while it is tilted, even when the tilt support lever or knob is locked. Severe injury could occur if the outboard motor accidentally falls.

1. Tilt the outboard motor so that the gear oil drain screw is at the lowest point possible.
2. Place a suitable container under the gear case.
3. Remove the gear oil drain screw and gasket. **NOTICE: If there is an excessive quantity of metal particles on the magnetic gear oil drain screw, this can indicate lower unit problem. Consult your Yamaha dealer.** [ECM01900]

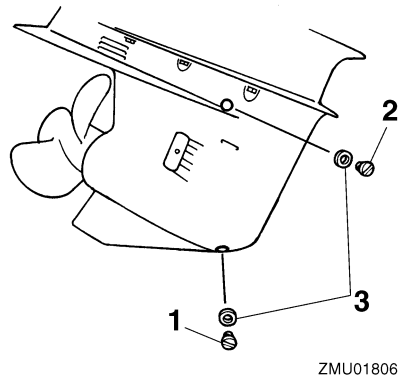

1. Gear oil drain screw
2. Oil level plug
3. Gasket

## TIP:

- If a magnetic gear oil drain screw is equipped, remove all metal particles from the screw before installing it.
- Always use new gaskets. Do not reuse the removed gaskets.

# Maintenance

- Remove the oil level plug and gasket to allow the oil to drain completely.  
**NOTICE: Check the used gear oil after it has been drained. If the gear oil is milky or contains water or a large amount of metal particles, the gear case may be damaged. Have a Yamaha dealer check and repair the outboard motor.** [ECM00713]

## TIP:

For disposal of used oil, consult your Yamaha dealer.

- Put the outboard motor in a vertical position. Using a flexible or pressurized filling device, inject the gear oil into the gear oil drain screw hole.

Recommended gear oil:  
Hypoid gear oil SAE#90  
Gear oil quantity:  
F200CET 1.150 L (1.216 US qt,  
1.012 Imp.qt)  
F225BET 1.150 L (1.216 US qt,  
1.012 Imp.qt)  
FL200CET 1.000 L (1.057 US qt,  
0.880 Imp.qt)  
FL225BET 1.000 L (1.057 US qt,  
0.880 Imp.qt)

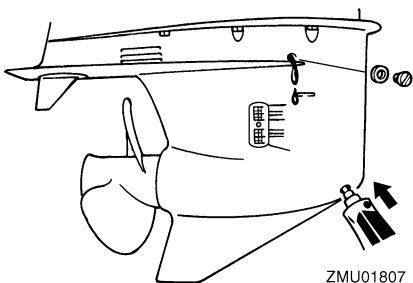

- Put a new gasket on the oil level plug. When the oil begins to flow out of the oil level plug hole, insert and tighten the oil level plug.

Tightening torque:  
9.0 Nm (0.92 kgf-m, 6.6 ft-lb)

- Put a new gasket on the gear oil drain screw. Insert and tighten the gear oil drain screw.

Tightening torque:  
9.0 Nm (0.92 kgf-m, 6.6 ft-lb)

## F225C, F250A, FL250A

EWM00800

### WARNING

- Be sure the outboard motor is securely fastened to the transom or a stable stand. You could be severely injured if the outboard motor falls on you.
- Never get under the lower unit while it is tilted, even when the tilt support lever or knob is locked. Severe injury could occur if the outboard motor accidentally falls.

- Tilt the outboard motor so that the gear oil drain screw is at the lowest point possible.
- Place a suitable container under the gear case.
- Remove the cooling water inlet covers on both sides of the gear case. Be careful not to lose the bolt and nut.
- Remove the gear oil drain screw and gasket. The screw is magnetic so a small quantity of metal particles on the end of the screw is normal. Simply remove them. **NOTICE: If there is an excessive quantity of metal particles on the magnetic gear oil drain screw, this can indicate lower unit problem. Consult your Yamaha dealer.** [ECM01900]

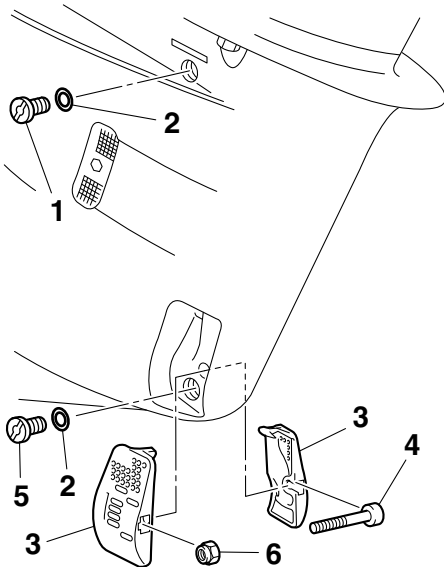

ZMU05487

1. Oil level plug
2. Gasket
3. Cooling water inlet cover
4. Bolt
5. Gear oil drain screw
6. Nut

5. Remove the oil level plug and gasket to allow the oil to drain completely.  
**NOTICE:** Check the used gear oil after it has been drained. If the gear oil is milky or contains water or a large amount of metal particles, the gear case may be damaged. Have a Yamaha dealer check and repair the outboard motor. [ECM00713]

## TIP:

For disposal of used oil, consult your Yamaha dealer.

6. Put the outboard motor in a vertical position. Using a flexible or pressurized filling device, inject the gear oil into the gear oil drain screw hole.

Recommended gear oil:  
Hypoid gear oil SAE#90

Gear oil quantity:

F225CET 0.920 L (0.972 US qt,  
0.810 Imp.qt)

F250AET 0.920 L (0.972 US qt,  
0.810 Imp.qt)

FL250AET 0.800 L (0.846 US qt,  
0.704 Imp.qt)

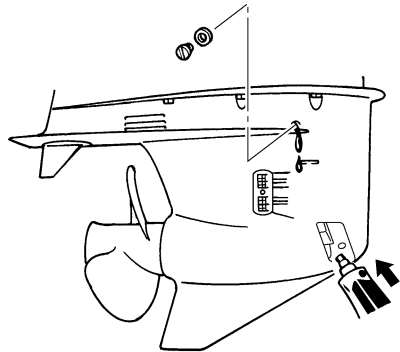

ZMU05488

7. Put a new gasket on the oil level plug. When the oil begins to flow out of the oil level plug hole, insert and tighten the oil level plug.

Tightening torque:

9.0 Nm (0.92 kgf-m, 6.6 ft-lb)

8. Put a new gasket on the gear oil drain screw. Insert and tighten the gear oil drain screw.

Tightening torque:

9.0 Nm (0.92 kgf-m, 6.6 ft-lb)

9. Securely install the cooling water inlet covers on both sides of the gear case using the bolt and nut removed earlier.

# Maintenance

Tightening torque:  
2.0 Nm (0.20 kgf-m, 1.5 ft-lb)

EMU29314

## Inspecting and replacing anode(s)

Yamaha outboard motors are protected from corrosion by sacrificial anodes. Inspect the external anodes periodically. Remove scales from the surfaces of the anodes. Consult a Yamaha dealer for replacement of external anodes.

ECM00720

### **NOTICE**

**Do not paint anodes, as this would render them ineffective.**

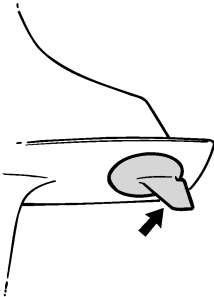

ZMU01808

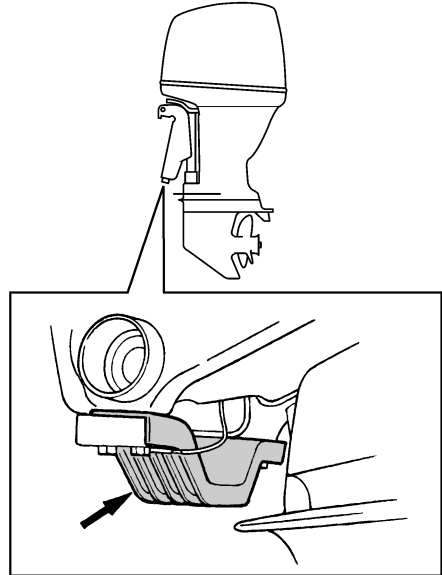

ZMU05353

### **TIP:**

Inspect ground leads attached to external anodes on equipped models. Consult a Yamaha dealer for inspection and replacement of internal anodes attached to the power unit.

EMU29323

## Checking battery (for electric start models)

EWM01902

### **! WARNING**

**Battery electrolyte is poisonous and caustic, and batteries generate explosive hydrogen gas. When working near the battery:**

- **Wear protective eye gear and rubber gloves.**
- **Do not smoke or bring any other source of ignition near the battery.**

The procedure for checking the battery varies for different batteries. This procedure contains typical checks that apply to many batteries, but you should always refer to the battery manufacturer's instructions.

ECM01920

## NOTICE

**A poorly maintained battery will quickly deteriorate.**

1. Check the electrolyte level.

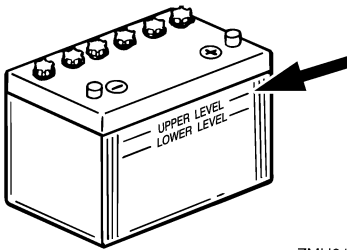

ZMU01810

2. Check the battery's charge. If your boat is equipped with the digital speedometer, the voltmeter and low battery alert functions will help you monitor the battery's charge. If the battery needs charging, consult your Yamaha dealer.
3. Check the battery connections. They should be clean, secure, and covered by an insulating cover. **WARNING! Bad connections can produce shorting or arcing and cause an explosion.** [EWM01912]

EMU35605

## Connecting the battery

EWM00572

### **WARNING**

**Mount the battery holder securely in a dry, well-ventilated, vibration-free location in the boat. Install a fully charged battery in the holder.**

ECM01124

## NOTICE

**Do not reverse the battery cables. Otherwise, the electrical parts could be damaged.**

1. Make sure the main switch (on applicable models) is "OFF" (off) before working on the battery.
2. Connect the red battery cable to the POSITIVE (+) terminal first. Then connect the black battery cable to the NEGATIVE (-) terminal.

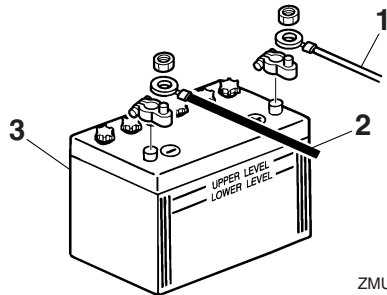

ZMU01811

1. Red cable
  2. Black cable
  3. Battery
3. The electrical contacts of the battery and cables must be clean and properly connected, or the battery will not start the engine.

### Connecting an accessory battery (optional)

If connecting an accessory battery, consult your Yamaha dealer about correct wiring. It is recommendable to install the fuse to the isolator lead as shown in the illustration. For the fuse size, be sure to follow local regulations. For example, for USA, the ABYC rules (E-11) should be observed.

# Maintenance

## Single engine

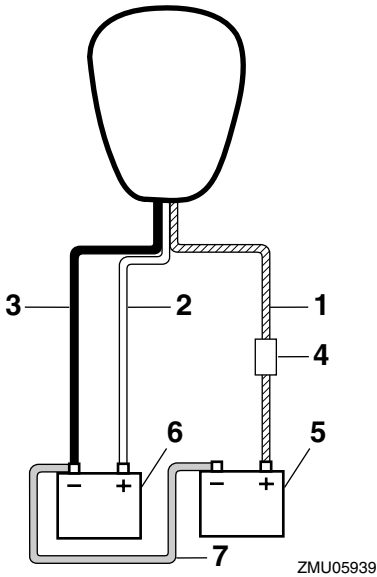

1. Isolator lead with circuit protection
2. Red cable
3. Black cable
4. Fuse
5. Battery for accessories
6. Battery for starting
7. Negative connecting cable

## Twin engines

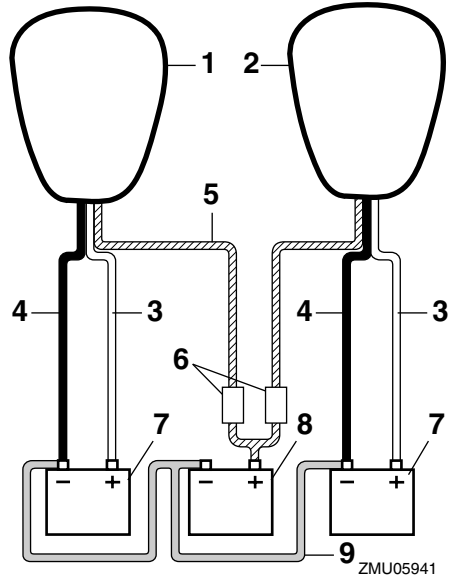

1. Starboard side engine
2. Port side engine
3. Red cable
4. Black cable
5. Isolator leads with circuit protection
6. Fuse
7. Battery for starting
8. Battery for accessories
9. Negative connecting cable

EMU29371

### Disconnecting the battery

1. Turn off the battery cut-off switch (if equipped) and main switch. **NOTICE: If they are left on, the electrical system can be damaged.** [ECM01930]
2. Disconnect the negative cable(s) from the negative (-) terminal. **NOTICE: Always disconnect all negative (-) cables first to avoid a short circuit and damage to the electrical system.**

[ECM01940]

3. Disconnect the positive cable(s) and remove the battery from the boat.
4. Clean, maintain, and store the battery according to the manufacturer's instructions.

# Trouble Recovery

---

EMU29427

## Troubleshooting

A problem in the fuel, compression, or ignition systems can cause poor starting, loss of power, or other problems. This section describes basic checks and possible remedies, and covers all Yamaha outboard motors. Therefore some items may not apply to your model.

If your outboard motor requires repair, bring it to your Yamaha dealer.

If the engine trouble-alert indicator is flashing, consult your Yamaha dealer.

### **Starter will not operate.**

Q. Is battery capacity weak or low?

A. Check battery condition. Use battery of recommended capacity.

Q. Are battery connections loose or corroded?

A. Tighten battery cables and clean battery terminals.

Q. Is fuse for electric start relay or electric circuit blown?

A. Check for cause of electric overload and repair. Replace fuse with one of correct amperage.

Q. Are starter components faulty?

A. Have serviced by a Yamaha dealer.

Q. Is shift lever in gear?

A. Shift to neutral.

### **Engine will not start (starter operates).**

Q. Is fuel tank empty?

A. Fill tank with clean, fresh fuel.

Q. Is fuel contaminated or stale?

A. Fill tank with clean, fresh fuel.

Q. Is fuel filter clogged?

A. Clean or replace filter.

Q. Is starting procedure incorrect?

A. See page 47.

Q. Has fuel pump malfunctioned?

A. Have serviced by a Yamaha dealer.

Q. Are spark plug(s) fouled or of incorrect type?

A. Inspect spark plug(s). Clean or replace with recommended type.

Q. Are spark plug cap(s) fitted incorrectly?

A. Check and re-fit cap(s).

Q. Is ignition wiring damaged or poorly connected?

A. Check wires for wear or breaks. Tighten all loose connections. Replace worn or broken wires.

Q. Are ignition parts faulty?

A. Have serviced by a Yamaha dealer.

Q. Is engine shut-off cord (lanyard) not attached?

A. Attach cord.

Q. Are engine inner parts damaged?

A. Have serviced by a Yamaha dealer.

### **Engine idles irregularly or stalls.**

Q. Are spark plug(s) fouled or of incorrect type?

A. Inspect spark plug(s). Clean or replace with recommended type.

Q. Is fuel system obstructed?



# Trouble Recovery

---

A. Check for pinched or kinked fuel line or other obstructions in fuel system.

Q. Is fuel contaminated or stale?

A. Fill tank with clean, fresh fuel.

Q. Is fuel filter clogged?

A. Clean or replace filter.

Q. Have ignition parts failed?

A. Have serviced by a Yamaha dealer.

Q. Has alert system activated?

A. Find and correct cause of alert.

Q. Is spark plug gap incorrect?

A. Inspect and adjust as specified.

Q. Is ignition wiring damaged or poorly connected?

A. Check wires for wear or breaks. Tighten all loose connections. Replace worn or broken wires.

Q. Is specified engine oil not being used?

A. Check and replace oil as specified.

Q. Is thermostat faulty or clogged?

A. Have serviced by a Yamaha dealer.

Q. Are carburetor adjustments incorrect?

A. Have serviced by a Yamaha dealer.

Q. Is fuel pump damaged?

A. Have serviced by a Yamaha dealer.

Q. Is air vent screw on fuel tank closed?

A. Open air vent screw.

Q. Is choke knob pulled out?

A. Return to home position.

Q. Is motor angle too high?

A. Return to normal operating position.

Q. Is carburetor clogged?

A. Have serviced by a Yamaha dealer.

Q. Is fuel joint connection incorrect?

A. Connect correctly.

Q. Is throttle valve adjustment incorrect?

A. Have serviced by a Yamaha dealer.

Q. Is battery cable disconnected?

A. Connect securely.

## **Alert buzzer sounds or indicator lights.**

Q. Is cooling system clogged?

A. Check water intake for restriction.

Q. Is engine oil level low?

A. Fill oil tank with specified engine oil.

Q. Is heat range of spark plug incorrect?

A. Inspect spark plug and replace it with recommended type.

Q. Is specified engine oil not being used?

A. Check and replace oil with specified type.

Q. Is engine oil contaminated or deteriorated?

A. Replace oil with fresh, specified type.

Q. Is oil filter clogged?

A. Have serviced by a Yamaha dealer.

Q. Has oil feed/injection pump malfunctioned?

A. Have serviced by a Yamaha dealer.

# Trouble Recovery

---

Q. Is load on boat improperly distributed?

A. Distribute load to place boat on an even plane.

Q. Is water pump or thermostat faulty?

A. Have serviced by a Yamaha dealer.

Q. Is there excess water in fuel filter cup?

A. Drain filter cup.

## Engine power loss.

Q. Is propeller damaged?

A. Have propeller repaired or replaced.

Q. Is propeller pitch or diameter incorrect?

A. Install correct propeller to operate outboard at its recommended speed (r/min) range.

Q. Is trim angle incorrect?

A. Adjust trim angle to achieve most efficient operation.

Q. Is motor mounted at incorrect height on transom?

A. Have motor adjusted to proper transom height.

Q. Has alert system activated?

A. Find and correct cause of alert.

Q. Is boat bottom fouled with marine growth?

A. Clean boat bottom.

Q. Are spark plug(s) fouled or of incorrect type?

A. Inspect spark plug(s). Clean or replace with recommended type.

Q. Are weeds or other foreign matter tangled on gear housing?

A. Remove foreign matter and clean lower unit.

Q. Is fuel system obstructed?

A. Check for pinched or kinked fuel line or other obstructions in fuel system.

Q. Is fuel filter clogged?

A. Clean or replace filter.

Q. Is fuel contaminated or stale?

A. Fill tank with clean, fresh fuel.

Q. Is spark plug gap incorrect?

A. Inspect and adjust as specified.

Q. Is ignition wiring damaged or poorly connected?

A. Check wires for wear or breaks. Tighten all loose connections. Replace worn or broken wires.

Q. Have electrical parts failed?

A. Have serviced by a Yamaha dealer.

Q. Is specified fuel not being used?

A. Replace fuel with specified type.

Q. Is specified engine oil not being used?

A. Check and replace oil with specified type.

Q. Is thermostat faulty or clogged?

A. Have serviced by a Yamaha dealer.

Q. Is air vent screw closed?

A. Open the air vent screw.

Q. Is fuel pump damaged?

A. Have serviced by a Yamaha dealer.

Q. Is fuel joint connection incorrect?

# Trouble Recovery

A. Connect correctly.

Q. Is heat range of spark plug incorrect?

A. Inspect spark plug and replace it with recommended type.

Q. Is high pressure fuel pump drive belt broken?

A. Have serviced by a Yamaha dealer.

Q. Is engine not responding properly to shift lever position?

A. Have serviced by a Yamaha dealer.

## Engine vibrates excessively.

Q. Is propeller damaged?

A. Have propeller repaired or replaced.

Q. Is propeller shaft damaged?

A. Have serviced by a Yamaha dealer.

Q. Are weeds or other foreign matter tangled on propeller?

A. Remove and clean propeller.

Q. Is motor mounting bolt loose?

A. Tighten bolt.

Q. Is steering pivot loose or damaged?

A. Tighten or have serviced by a Yamaha dealer.

EMU29433

## Temporary action in emergency

EMU29441

### Impact damage

EWM00870

#### **WARNING**

The outboard motor can be seriously damaged by a collision while operating or trailering. Damage could make the outboard motor unsafe to operate.

If the outboard motor hits an object in the water, follow the procedure below.

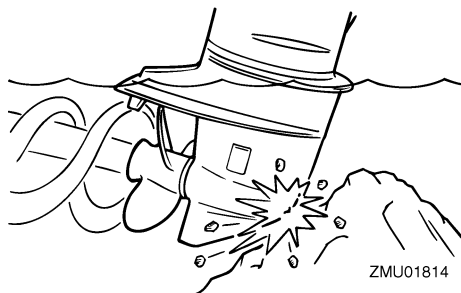

1. Stop the engine immediately.
2. Check the control system and all components for damage. Also, check the boat for damage.
3. Whether damage is found or not, return to the nearest harbor slowly and carefully.
4. Have a Yamaha dealer check the outboard motor before operating it again.

EMU29453

## Running single engine (twin engines)

When using only one engine in an emergency, be sure to keep the unused one tilted up and operate the other engine at low speed.

ECM00370

### **NOTICE**

If the boat is operated with one engine in the water but not running, water may run into the exhaust pipe due to wave action, causing engine trouble.

# Trouble Recovery

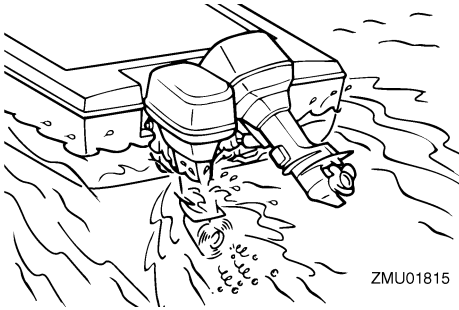

## TIP:

When you are maneuvering at low speed, such as near a dock, it is recommended that both engines be running with one in neutral gear if possible.

EMU29474

## Replacing fuse

If a fuse has blown, remove the electrical cover, open the fuse holder and remove the fuse with a fuse puller (if equipped). Replace it with a spare one of the proper amperage.

EWM00631

## WARNING

**Substituting an incorrect fuse or a piece of wire could allow excessive current flow. This could cause electric system damage and a fire hazard.**

Consult your Yamaha dealer if the new fuse immediately blows again.

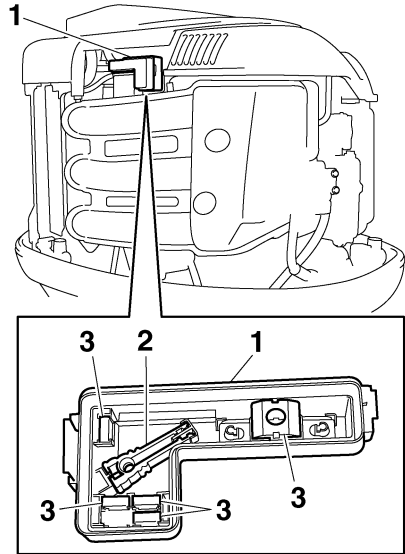

1. Electrical cover
2. Fuse puller
3. Spare fuse (10 A, 15 A, 20 A, 30 A, 60 A)

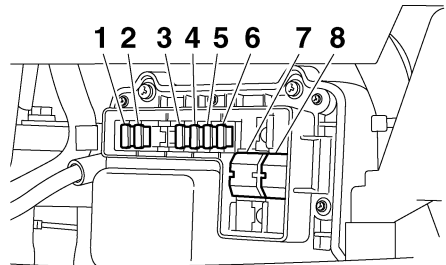

1. Electric throttle valve / ECM (Electronic control module) fuse (10 A)
2. Ignition coil / Fuel injector / Variable camshaft timing / ECM (Electronic Control Module) fuse (30 A)
3. Main switch / PTT switch fuse (20 A)
4. Starter relay fuse (30 A)
5. Fuel feed pump fuse (10 A)
6. Fuel pump fuse (15 A)

# Trouble Recovery

7. Engine main fuse (60 A)
8. Isolator fuse (60 A)

EMU29525

## Power trim and tilt will not operate

If the engine cannot be tilted up or down with the power trim and tilt because of a discharged battery or a failure with the power trim and tilt unit, the engine can be tilted manually.

1. Loosen the manual valve screw by turning it counterclockwise until it stops.

**F200C, FL200C, F225B, FL225B, F250A, FL250A**

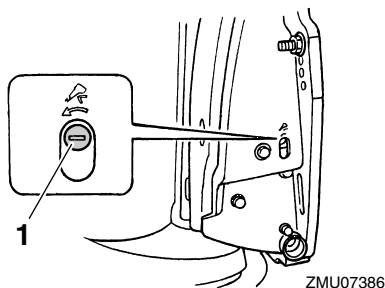

1. Manual valve screw

## F225C

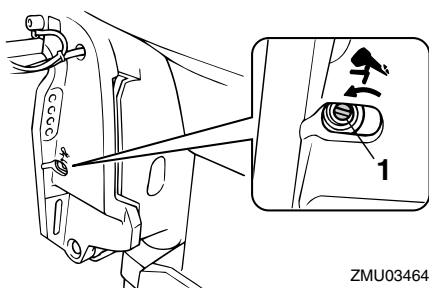

1. Manual valve screw
2. Put the engine in the desired position, then tighten the manual valve screw by turning it clockwise.

EMU37571

## Water separator-alert indicator blinks while cruising

EWM01500

### **WARNING**

Gasoline is highly flammable, and its vapors are flammable and explosive.

- Do not perform this procedure on a hot or running engine. Allow the engine to cool.
- There will be fuel in the fuel filter. Keep away from sparks, cigarettes, flames or other sources of ignition.
- This procedure will allow some fuel to spill. Catch fuel in a rag. Wipe up any spilled fuel immediately.
- The fuel filter must be reassembled carefully with the O-ring, filter cup, and hoses in place. Improper assembly or replacement could result in a fuel leak, which could result in a fire or explosion hazard.

If the water separator-alert indicator on the 6Y8 Multifunction tachometer blinks, perform the following procedure.

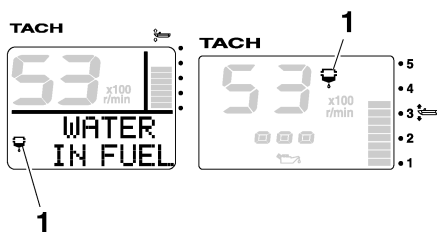

1. Water separator-alert indicator
  1. Stop the engine.
  2. Remove the top cowling.
  3. Remove the holder.

# Trouble Recovery

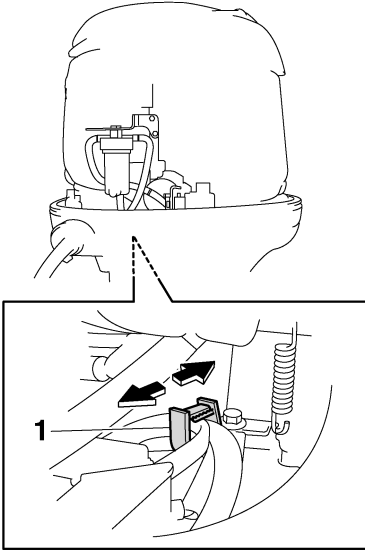

ZMU05443

1. Holder
4. Disconnect the water detection switch coupler. **NOTICE: Be careful not to get any water on the water detection switch coupler, otherwise a malfunction could occur.** [ECM01950]

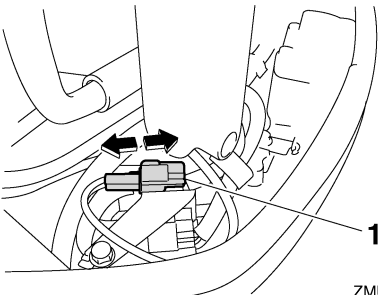

ZMU05444

1. Water detection switch coupler
5. Unscrew the filter cup from the filter housing. **NOTICE: Be careful not to twist the water detection switch lead when unscrewing the filter cup.** [ECM01960]

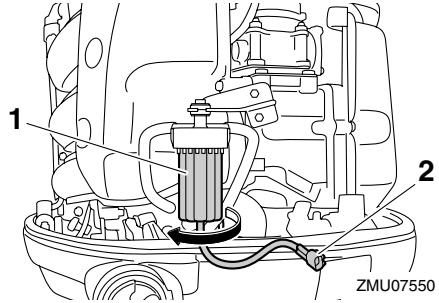

1. Filter cup
2. Water detection switch lead
6. Drain the water in the filter cup by soaking it up with a rag.
7. Firmly screw the filter cup onto the filter housing. **NOTICE: Be careful not to twist the water detection switch lead when screwing the filter cup onto the filter housing.** [ECM01970]
8. Connect the water detection switch coupler securely until a click is heard.

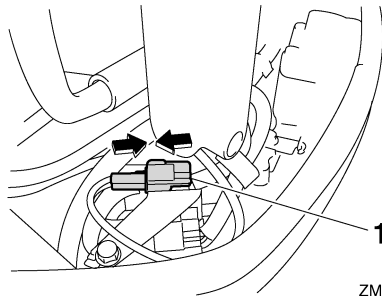

ZMU05446

1. Water detection switch coupler
9. Fasten the water detection switch lead with the holder.

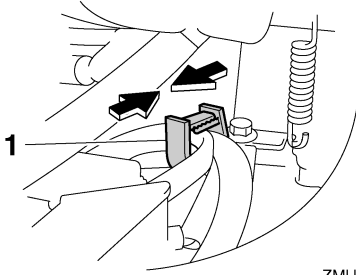

ZMU05447

1. Holder

10. Install the top cowling.
11. Start the engine and make sure that the water separator-alert indicator remains off. Have a Yamaha dealer inspect the outboard motor after returning to port.

EMU33501

## Treatment of submerged motor

If the outboard motor is submerged, immediately take it to a Yamaha dealer. Otherwise some corrosion may begin almost immediately. **NOTICE: Do not attempt to run the outboard motor until it has been completely inspected.** [ECM00401]



Printed in Japan  
December 2012-0.1 × 1 CR

Printed on recycled paper