



YAMAHA



30D

OWNER'S MANUAL

6J8-28199-72-E0

EMU25050

Read this owner's manual carefully before operating your outboard motor.

Important manual information

EMU25101

To the owner

Thank you for choosing a Yamaha outboard motor. This Owner's Manual contains information needed for proper operation, maintenance and care. A thorough understanding of these simple instructions will help you obtain maximum enjoyment from your new Yamaha. If you have any question about the operation or maintenance of your outboard motor, please consult a Yamaha dealer.

In this Owner's Manual particularly important information is distinguished in the following ways.



The Safety Alert Symbol means **ATTENTION! BECOME ALERT! YOUR SAFETY IS INVOLVED!**

EWM00780



WARNING

Failure to follow WARNING instructions could result in severe injury or death to the machine operator, a bystander, or a person inspecting or repairing the outboard motor.

ECM00700

CAUTION:

A CAUTION indicates special precautions that must be taken to avoid damage to the outboard motor.

NOTE:

A NOTE provides key information to make procedures easier or clearer.

Yamaha continually seeks advancements in product design and quality. Therefore, while this manual contains the most current product information available at the time of printing, there may be minor discrepancies between your machine and this manual. If there is any question concerning this manu-

al, please consult your Yamaha dealer.

To ensure long product life, Yamaha recommends that you use the product and perform the specified periodic inspections and maintenance by correctly following the instructions in the owner's manual. Note that if you do not follow these instructions, not only may the product break down, but the warranty will also be voided.

Some countries have laws or regulations restricting users from taking the product out of the country where it was purchased, and it may be impossible to register the product in the destination country. Additionally, the warranty may not apply in certain regions. When planning to take the product to another country, consult the dealer where the product was purchased for further information.

If the product was purchased used, please consult your closest dealer for customer re-registration, and to be eligible for the specified services.

NOTE:

The 30DEO, 30DMHO, 30DETO and the standard accessories are used as a base for the explanations and illustrations in this manual. Therefore some items may not apply to every model.

EMU25120

30D

OWNER'S MANUAL

©2006 by Yamaha Motor Co., Ltd.

1st Edition, February 2006

All rights reserved.

Any reprinting or unauthorized use

without the written permission of

Yamaha Motor Co., Ltd.

is expressly prohibited.

Printed in Japan

Table of contents

General information	1	Tilt lock mechanism.....	13
Identification numbers record	1	Tilt support knob.....	13
Outboard motor serial number	1	Tilt support lever for manual tilt model	14
Key number.....	1	Top cowling lock lever(s) (turn type).....	14
EC label.....	1	2-pin connector	14
Safety information	2	Battery charging information	15
Important labels.....	3	Warning indicator	15
Warning labels	3	Warning system	15
Fueling instructions	3	Overheat warning.....	15
Gasoline.....	4	Oil level warning and oil filter clogging warning	16
Engine oil	4	Operation	17
Battery requirement.....	4	Installation.....	17
Battery specifications	4	Mounting the outboard motor	17
Without a rectifier or Rectifier Regulator	4	Clamping the outboard motor.....	18
Propeller selection.....	4	Breaking in engine	19
Start-in-gear protection	5	Gasoline and engine oil mixing chart (50:1).....	19
Basic components	6	Procedure for oil injection models ...	19
Main components.....	6	Preoperation checks	20
Fuel tank	6	Fuel	20
Fuel joint	7	Oil.....	20
Fuel gauge	7	Controls.....	20
Fuel tank cap	7	Engine	20
Air vent screw	7	Operation after long period of storage	20
Remote control.....	7	Filling fuel and engine oil	21
Remote control lever.....	7	Filling fuel for portable tank	21
Neutral interlock trigger.....	8	Filling oil for manual starter model	21
Neutral throttle lever.....	8	Filling oil for electric start models ...	22
Choke switch.....	8	Oil level indicator operation	23
Tiller handle	8	Operating engine	23
Gear shift lever.....	9	Feeding fuel (portable tank)	23
Throttle grip.....	9	Starting engine.....	24
Throttle indicator	9	Warming up engine.....	27
Throttle friction adjuster.....	9	Choke start models	27
Engine stop lanyard switch	10	Shifting.....	28
Engine stop button	11	Forward (tiller handle and remote control models)	28
Choke knob for pull type	11	Reverse (automatic reverse lock and power trim and tilt models).....	28
Manual starter handle	11	Reverse (manual tilt and hydro tilt	
Main switch	11		
Steering friction adjuster	11		
Power trim and tilt switch on remote control or tiller handle	12		
Trim tab with anode	12		
Trim rod (tilt pin).....	13		
Shallow water lever.....	13		

Table of contents

models).....	29	Checking wiring and connectors	52
Stopping engine	30	Exhaust leakage.....	52
Procedure	30	Water leakage	52
Trimming outboard motor.....	30	Checking power trim and tilt /	
Adjusting trim angle for manual tilt		power tilt system	53
models	31	Checking propeller	53
Adjusting trim angle (power tilt		Removing the propeller	54
models).....	32	Installing the Propeller.....	54
Adjusting boat trim	32	Changing gear oil	55
Tilting up and down	33	Cleaning fuel tank	56
Procedure for tilting up (manual tilt		Inspecting and replacing	
models).....	33	anode(s).....	57
Procedure for tilting up.....	34	Checking battery (for electric start	
Procedure for tilting down		models)	57
(manual and hydro tilt models)	35	Connecting the battery	58
Procedure for tilting down	36	Disconnecting the battery.....	59
Cruising in shallow water	36	Checking top cowling	59
Cruising in shallow water		Coating the boat bottom	59
(manual tilt models)	36	Trouble Recovery.....	60
Power trim and tilt models /		Troubleshooting	60
power tilt models	38	Temporary action in emergency ...	63
Cruising in other conditions.....	38	Impact damage	63
Maintenance.....	39	Replacing fuse	63
Specifications	39	Power trim and tilt / power tilt will	
Transporting and storing outboard		not operate	64
motor	40	Starter will not operate	64
Clamp screw mounting models.....	40	Emergency starting engine	65
Storing outboard motor	41	Treatment of submerged motor	66
Procedure	41	Procedure.....	66
Lubrication (oil injection models)....	43		
Battery care.....	44		
Cleaning the outboard motor	44		
Checking painted surface of			
motor.....	45		
Periodic maintenance.....	45		
Replacement parts	45		
Maintenance chart	46		
Greasing	48		
Cleaning and adjusting spark			
plug	49		
Checking fuel system.....	50		
Inspecting fuel filter	51		
Cleaning fuel filter	51		
Inspecting idling speed	51		
Checking water in engine oil tank ...	52		

General information

EMU25170

Identification numbers record

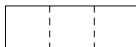

EMU25183

Outboard motor serial number

The outboard motor serial number is stamped on the label attached to the port side of the clamp bracket.

Record your outboard motor serial number in the spaces provided to assist you in ordering spare parts from your Yamaha dealer or for reference in case your outboard motor is stolen.

ZMU01693

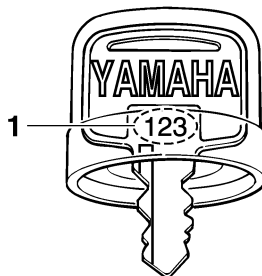

ZMU01694

1. Key number

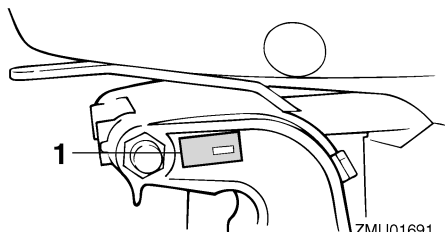

ZMU01691

1. Outboard motor serial number location

EMU25202

EC label

Engines affixed with this label conform to certain portions of the European Parliament directive relating to machinery. Refer to the label and the EC Declaration of Conformity for more details.

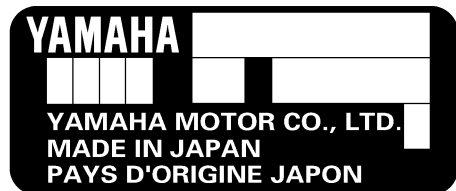

ZMU01692

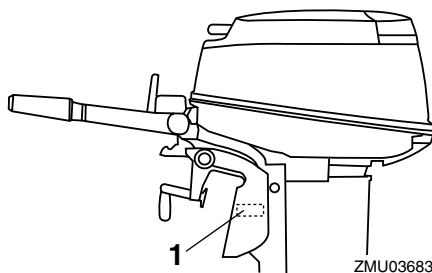

ZMU03683

1. EC label location

EMU25190

Key number

If a main key switch is equipped with the motor, the key identification number is stamped on your key as shown in the illustration. Record this number in the space provided for reference in case you need a new key.

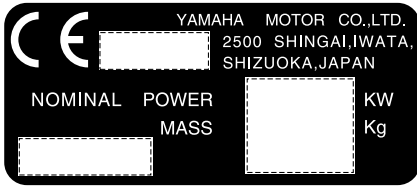

ZMU01696

EMU25371

Safety information

- Before mounting or operating the outboard motor, read this entire manual. Reading it should give you an understanding of the motor and its operation.
- Before operating the boat, read any owner's or operator's manuals supplied with it and all labels. Be sure you understand each item before operating.
- Do not overpower the boat with this outboard motor. Overpowering the boat could result in loss of control. The rated power of the outboard should be equal to or less than the rated horsepower capacity of the boat. If the rated horsepower capacity of the boat is unknown, consult the dealer or boat manufacturer.
- Do not modify the outboard. Modifications could make the motor unfit or unsafe to use.
- Incorrect propeller selection and incorrect use may not only cause engine damage, but also adversely affect fuel consumption. Consult your dealer for correct use.
- Never operate after drinking alcohol or taking drugs. About 50% of all boating fatalities involve intoxication.
- Have an approved personal flotation device (PFD) on board for every occupant. It is a good idea to wear a PFD whenever boating. At a minimum, children and non-swimmers should always wear PFDs, and everyone should wear PFDs when there are potentially hazardous boating conditions.
- Gasoline is highly flammable, and its vapors are flammable and explosive. Handle and store gasoline carefully. Make sure there are no gas fumes or leaking fuel before starting the engine.
- This product emits exhaust gases which contain carbon monoxide, a colorless, odorless gas which may cause brain damage or death when inhaled. Symptoms include nausea, dizziness, and drowsiness. Keep cockpit and cabin areas well ventilated. Avoid blocking exhaust outlets.
- Check throttle, shift, and steering for proper operation before starting the engine.
- Attach the engine stop switch lanyard to a secure place on your clothing, or your arm or leg while operating. If you accidentally leave the helm, the lanyard will pull from the switch, stopping the engine.
- Know the marine laws and regulations where you will be boating - and obey them.
- Stay informed about the weather. Check weather forecasts before boating. Avoid boating in hazardous weather.
- Tell someone where you are going: leave a Float Plan with a responsible person. Be sure to cancel the Float Plan when you return.
- Use common sense and good judgment when boating. Know your abilities, and be sure you understand how your boat handles under the different boating conditions you may encounter. Operate within your limits, and the limits of your boat. Always operate at safe speeds, and keep a careful

General information

watch for obstacles and other traffic.

- Always watch carefully for swimmers during the engine operation.
- Stay away from swimming areas.
- When a swimmer is in the water near you shift into neutral and shut off the engine.
- Do not illegally discard empty containers used to replace or replenish oil. For the correct processing of empty containers, consult the dealer where you purchased the oil.
- When replacing oils used to lubricate the product (engine or gear oil), be sure to wipe away any spilt oil. Never pour oil without using a funnel or similar device. If necessary, verify the necessary replacement procedure with the dealer.
- Never illegally discard (dump) the product. Yamaha recommends consulting the dealer on discarding the product.

EMU25382

Important labels

EMU25395

Warning labels

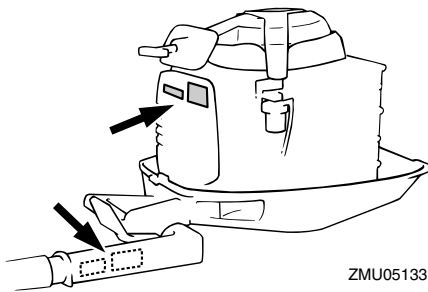

EMU25401

Label

EWM01260



- Be sure shift control is in neutral before starting engine. (except 2HP)
- Do not touch or remove electrical parts

when starting or during operation.

- Keep hands, hair, and clothes away from flywheel and other rotating parts while engine is running.

EMU25431

Label

EWM01300



- This engine is equipped with a neutral starting device.
- The engine will not start unless the shift control is in neutral position.

EMU25540

Fueling instructions

EWM00010



GASOLINE AND ITS VAPORS ARE HIGHLY FLAMMABLE AND EXPLOSIVE!

- Do not smoke when refueling, and keep away from sparks, flames, or other sources of ignition.
- Stop engine before refueling.
- Refuel in a well-ventilated area. Refuel portable fuel tanks off the boat.
- Take care not to spill gasoline. If gasoline spills, wipe it up immediately with dry rags.
- Do not overfill the fuel tank.
- Tighten the filler cap securely after refueling.
- If you should swallow some gasoline, inhale a lot of gasoline vapor, or get gasoline in your eyes, get immediate medical attention.
- If any gasoline spills onto your skin, immediately wash with soap and water. Change clothing if gasoline spills on it.
- Touch the fuel nozzle to the filler opening or funnel to help prevent electro-

General information

static sparks.

ECM00010

CAUTION:

Use only new clean gasoline which has been stored in clean containers and is not contaminated with water or foreign matter.

EMU25580

Gasoline

Recommended gasoline:

Regular unleaded gasoline with a minimum octane rating of 90 (Research Octane Number).

If knocking or pinging occurs, use a different brand of gasoline or premium unleaded fuel.

EMU25690

Engine oil

Recommended engine oil:

YAMALUBE 2-stroke outboard motor oil

If the recommended engine oil is not available, another 2-stroke engine oil with an NMMA-certified TC-W3 rating may be used.

EMU25690

Battery requirement

ECM01060

CAUTION:

Do not use a battery that does not meet the specified capacity. If a battery which does not meet specifications is used, the electric system could perform poorly or be overloaded, causing electric system damage.

For electric start models, choose a battery which meets the following specifications.

EMU25720

Battery specifications

Minimum cold cranking amps (CCA/EN):

30DEO 347.0 A

30DETO 347.0 A

Minimum rated capacity (20HR/IEC):

30DEO 40.0 Ah

30DETO 40.0 Ah

EMU25730

Without a rectifier or Rectifier

Regulator

ECM01090

CAUTION:

A battery cannot be connected to models that do not have a rectifier or Rectifier Regulator.

If you wish to use a battery with the models without a rectifier or Rectifier Regulator, install an optional Rectifier Regulator.

Using a maintenance-free battery with the above models can shorten the life of the battery significantly.

Install an optional Rectifier Regulator or use accessories rated to withstand 18 volts or higher with the above models. Consult your Yamaha dealer for details on installing an optional Rectifier Regulator.

EMU25742

Propeller selection

The performance of your outboard motor will be critically affected by your choice of propeller, as an incorrect choice could adversely affect performance and could also seriously damage the motor. Engine speed depends on the propeller size and boat load. If engine speed is too high or too low for good engine performance, this will have an adverse effect on the engine.

Yamaha outboard motors are fitted with propellers chosen to perform well over a range

General information

of applications, but there may be uses where a propeller with a different pitch would be more appropriate. For a greater operating load, a smaller-pitch propeller is more suitable as it enables the correct engine speed to be maintained. Conversely, a larger-pitch propeller is more suitable for a smaller operating load.

Yamaha dealers stock a range of propellers, and can advise you and install a propeller on your outboard that is best suited to your application.

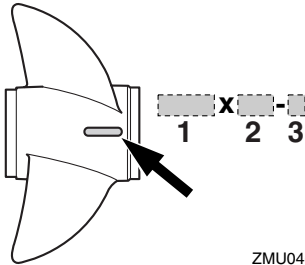

ZMU04605

1. Propeller diameter in inches
2. Propeller pitch in inches
3. Type of propeller (propeller mark)

NOTE:

Select a propeller which will allow the engine to reach the middle or upper half of the operating range at full throttle with the maximum boat load. If operating conditions such as light boat loads then allow the engine r/min to rise above the maximum recommended range, reduce the throttle setting to maintain the engine in the proper operating range.

For instructions on propeller removal and installation, see page 53.

EMU25760

Start-in-gear protection

Yamaha outboard motors affixed with the pictured label or Yamaha-approved remote

control units are equipped with start-in-gear protection device(s). This feature permits the engine to be started only when it is in neutral. Always select neutral before starting the engine.

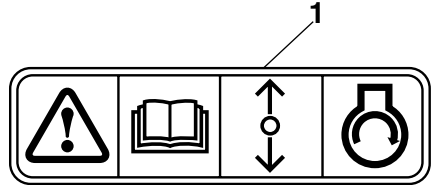

ZMU01713

1. Start-in-gear protection label

Basic components

EMU25797

Main components

NOTE:

* May not be exactly as shown; also may not be included as standard equipment on all models.

30DEO, 30DMHO, 30DETO

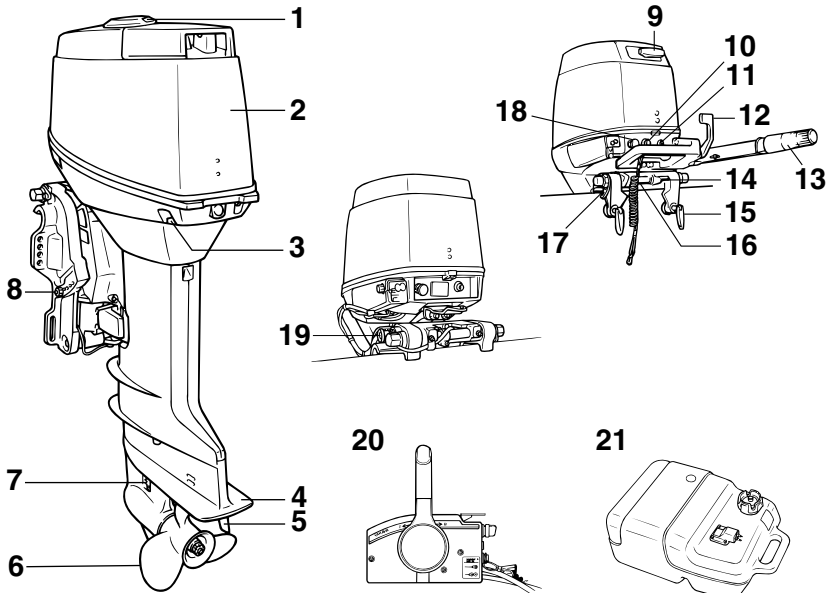

ZMU03758

1. Oil tank filler cap
2. Top cowling
3. Top cowling lock lever(s)
4. Anti-cavitation plate
5. Trim tab
6. Propeller*
7. Cooling water inlet
8. Tilt rod*
9. Manual starter handle*
10. Engine stop button/Engine stop lanyard switch*
11. Warning indicator*
12. Gear shift lever*
13. Throttle grip*

14. Tilt lock lever*
15. Transom clamp handle*
16. Shallow water lever*
17. Rope attachment
18. Choke knob
19. Tilt support knob*
20. Remote control box (side mount type)*
21. Fuel tank

EMU25802

Fuel tank

If your model was equipped with a portable

Basic components

fuel tank, its function is as follows.

EWM00020



The fuel tank supplied with this engine is its dedicated fuel reservoir and must not be used as a fuel storage container. Commercial users should conform to relevant licensing or approval authority regulations.

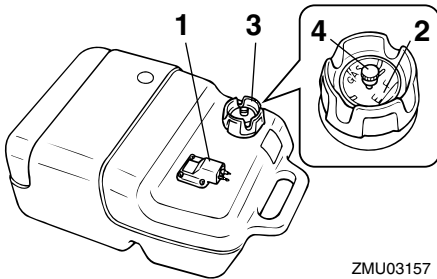

ZMU03157

1. Fuel joint
2. Fuel gauge
3. Fuel tank cap
4. Air vent screw

EMU25830

Fuel joint

This joint is used to connect the fuel line.

EMU25841

Fuel gauge

This gauge is located on either the fuel tank cap or on the fuel joint base. It shows the approximate amount of fuel remaining in the tank.

EMU25850

Fuel tank cap

This cap seals the fuel tank. When removed, the tank can be filled with fuel. To remove the cap, turn it counterclockwise.

EMU25860

Air vent screw

This screw is on the fuel tank cap. To loosen the screw, turn it counterclockwise.

EMU26180

Remote control

The remote control lever actuates both the shifter and the throttle. The electrical switches are mounted on the remote control box.

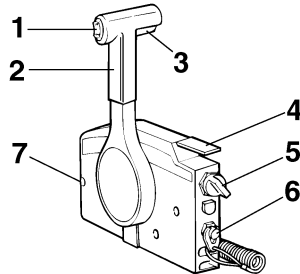

ZMU01723

1. Power trim and tilt switch
2. Remote control lever
3. Neutral interlock trigger
4. Neutral throttle lever
5. Main switch / choke switch
6. Engine stop lanyard switch
7. Throttle friction adjuster

EMU26190

Remote control lever

Moving the lever forward from the neutral position engages forward gear. Pulling the lever back from neutral engages reverse. The engine will continue to run at idle until the lever is moved about 35° (a detent can be felt). Moving the lever farther opens the throttle, and the engine will begin to accelerate.

Basic components

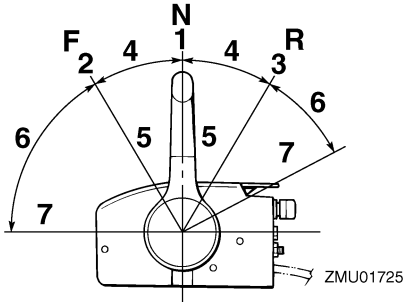

1. Neutral "N"
2. Forward "F"
3. Reverse "R"
4. Shift
5. Fully closed
6. Throttle
7. Fully open

EMU26201

Neutral interlock trigger

To shift out of neutral, first pull the neutral interlock trigger up.

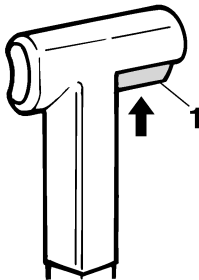

1. Neutral interlock trigger

EMU26211

Neutral throttle lever

To open the throttle without shifting into either forward or reverse, put the remote control lever in the neutral position and lift the neutral throttle lever.

NOTE: _____

The neutral throttle lever will operate only

when the remote control lever is in neutral. The remote control lever will operate only when the neutral throttle lever is in the closed position.

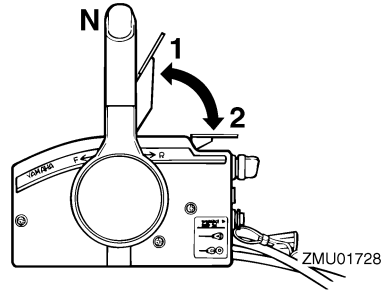

1. Fully open
2. Fully closed

EMU26221

Choke switch

To activate the choke system, press in the main switch while the key is turned to the "ON" (on) or "START" (start) position. The choke system will then supply the rich fuel mixture required to start the engine. When the key is released, the choke will switch off automatically.

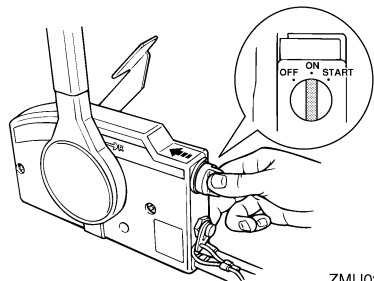

EMU25911

Tiller handle

To change direction, move the tiller handle to the left or right as necessary.

Basic components

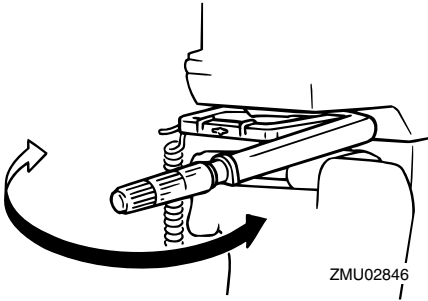

ZMU02846

EMU25922

Gear shift lever

Pulling the gear shift lever towards you puts the engine in forward gear so that the boat moves ahead. Pushing the lever away from you puts the engine in reverse gear so that the boat moves astern.

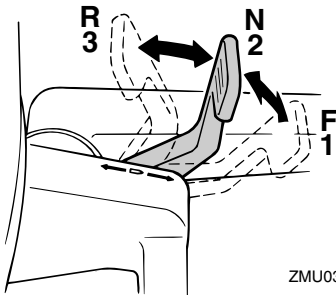

ZMU03687

1. Forward "F"
2. Neutral "N"
3. Reverse "R"

EMU25941

Throttle grip

The throttle grip is on the tiller handle. Turn the grip counterclockwise to increase speed and clockwise to decrease speed.

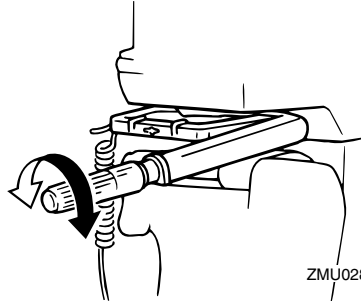

ZMU02848

EMU25961

Throttle indicator

The fuel consumption curve on the throttle indicator shows the relative amount of fuel consumed for each throttle position. Choose the setting that offers the best performance and fuel economy for the desired operation.

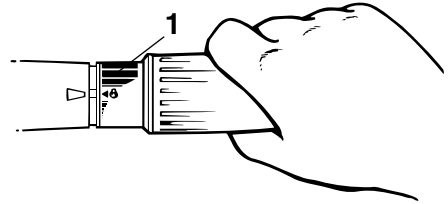

ZMU02849

1. Throttle indicator

EMU25971

Throttle friction adjuster

A friction device provides adjustable resistance to movement of the throttle grip or the remote control lever, and can be set according to operator preference.

To increase resistance, turn the adjuster clockwise. To decrease resistance, turn the adjuster counterclockwise.

EWM00031



WARNING

Do not overtighten the friction adjuster. If

Basic components

there is too much resistance, it could be difficult to move the remote control lever or throttle grip, which could result in an accident.

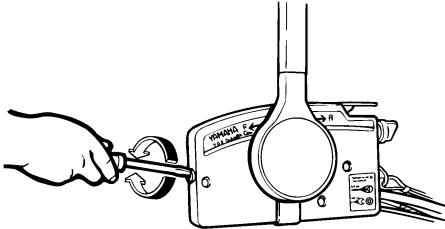

ZMU01714

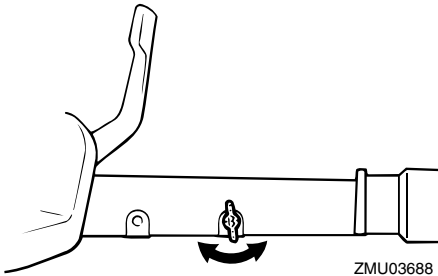

ZMU03688

When constant speed is desired, tighten the adjuster to maintain the desired throttle setting.

EMU25990

Engine stop lanyard switch

The lock plate must be attached to the engine stop switch for the engine to run. The lanyard should be attached to a secure place on the operator's clothing, or arm or leg. Should the operator fall overboard or leave the helm, the lanyard will pull out the lock plate, stopping ignition to the engine. This will prevent the boat from running away under power.

EWMO0120



WARNING

- Attach the engine stop switch lanyard

to a secure place on your clothing, or your arm or leg while operating.

- Do not attach the lanyard to clothing that could tear loose. Do not route the lanyard where it could become entangled, preventing it from functioning.
- Avoid accidentally pulling the lanyard during normal operation. Loss of engine power means the loss of most steering control. Also, without engine power, the boat could slow rapidly. This could cause people and objects in the boat to be thrown forward.

NOTE:

The engine cannot be started with the lock plate removed.

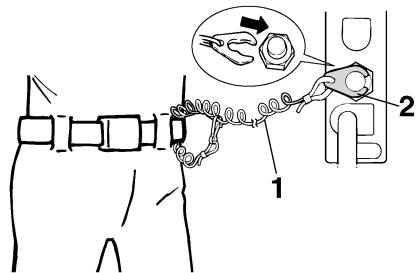

ZMU01716

1. Lanyard
2. Lock plate

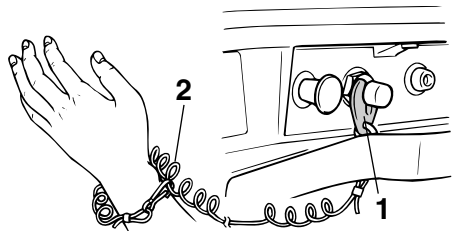

ZMU03759

1. Lock plate

Basic components

2. Lanyard

EMU26001

Engine stop button

To open the ignition circuit and stop the engine, push this button.

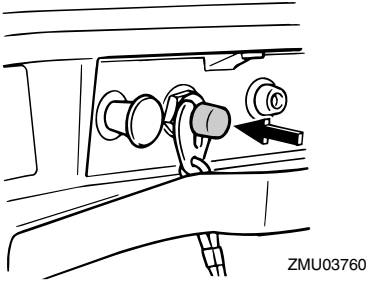

EMU26011

Choke knob for pull type

To supply the engine with the rich fuel mixture required to start, pull out this knob.

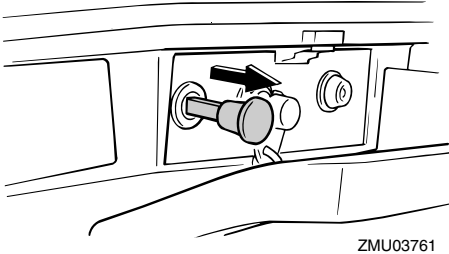

EMU26070

Manual starter handle

To start the engine, first gently pull the handle out until resistance is felt. From that position, then pull the handle straight out quickly to crank the engine.

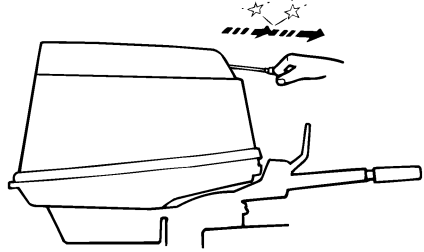

EMU26090

Main switch

The main switch controls the ignition system; its operation is described below.

- "OFF" (off)

With the main switch in the "OFF" (off) position, the electrical circuits are off, and the key can be removed.

- "ON" (on)

With the main switch in the "ON" (on) position, the electrical circuits are on, and the key cannot be removed.

- "START" (start)

With the main switch in the "START" (start) position, the starter motor turns to start the engine. When the key is released, it returns automatically to the "ON" (on) position.

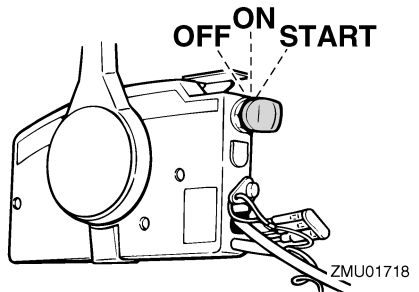

EMU26122

Steering friction adjuster

A friction device provides adjustable resistance to the steering mechanism, and can be

Basic components

set according to operator preference. An adjusting screw or bolt is located on the swivel bracket.

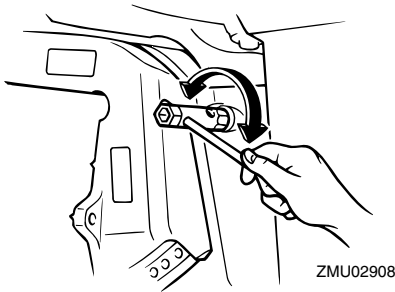

To increase resistance, turn the adjuster clockwise.

To decrease resistance, turn the adjuster counterclockwise.

EWM00040

WARNING

Do not overtighten the friction adjuster. If there is too much resistance, it could be difficult to steer, which could result in an accident.

EMU26141

Power trim and tilt switch on remote control or tiller handle

The power trim and tilt system adjusts the outboard motor angle in relation to the transom. Pressing the switch “UP” (up) trims the outboard motor up, then tilts it up. Pressing the switch “DN” (down) tilts the outboard motor down and trims it down. When the switch is released, the outboard motor will stop in its current position.

NOTE:

For instructions on using the power trim and tilt switch, see pages 30 and 33.

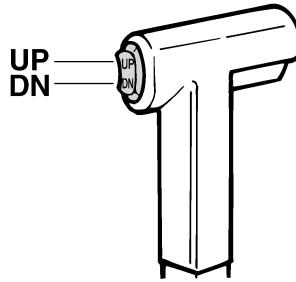

EMU26241

Trim tab with anode

The trim tab should be adjusted so that the steering control can be turned to either the right or left by applying the same amount of force.

EWM00840

WARNING

An improperly adjusted trim tab could cause difficult steering. Always test run after the trim tab has been installed or replaced to be sure steering is correct. Be sure you have tightened the bolt after adjusting the trim tab.

If the boat tends to veer the left (port side), turn the trim tab rear end to the port side “A” in the figure. If the boat tends to veer the right (starboard side), turn the trim tab end to the starboard side “B” in the figure.

ECM00840

CAUTION:

The trim tab also serves as an anode to protect the engine from electrochemical corrosion. Never paint the trim tab as it will become ineffective as an anode.

Basic components

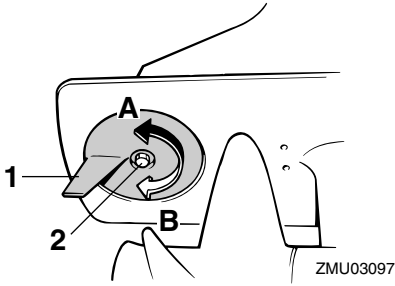

1. Trim tab
2. Bolt

EMU26261

Trim rod (tilt pin)

The position of the trim rod determines the minimum trim angle of the outboard motor in relation to the transom.

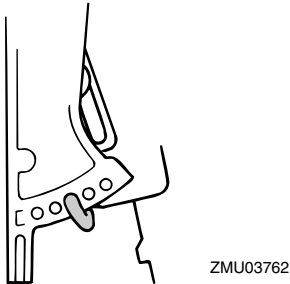

EMU26280

Shallow water lever

Pushing this lever down will tilt the motor up partially to provide more clearance when operating in shallow water.

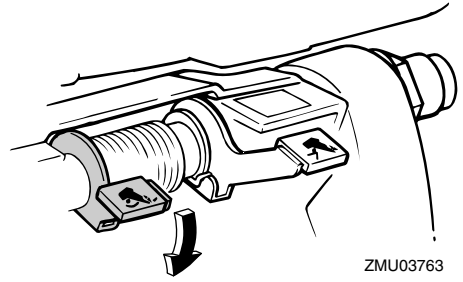



EMU26312

Tilt lock mechanism

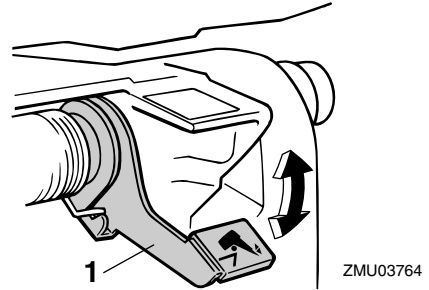
The tilt lock mechanism is used to prevent the outboard motor from lifting out of the water when in reverse gear.



1. Tilt lock lever

To lock it, set the tilt lock lever in the “” (lock) position. To release, push the tilt lock lever in the “” (release) position.

EMU26320

Tilt support knob

To keep the outboard motor in the tilted up position, push the tilt support knob under the swivel bracket.

Basic components

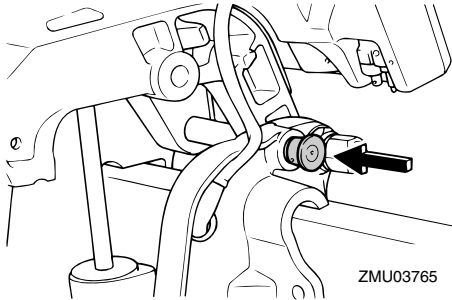

EMU26350

Tilt support lever for manual tilt model

To keep the outboard motor in the tilted up position, lock the tilt support lever to the swivel bracket.

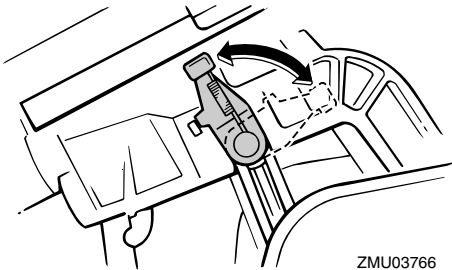

EMU26372

Top cowling lock lever(s) (turn type)

To remove the engine top cowling, turn the lock lever(s) and lift off the cowling. When installing the cowling, check to be sure it fits properly in the rubber seal. Then lock the cowling again by returning the lever(s) to the lock position.

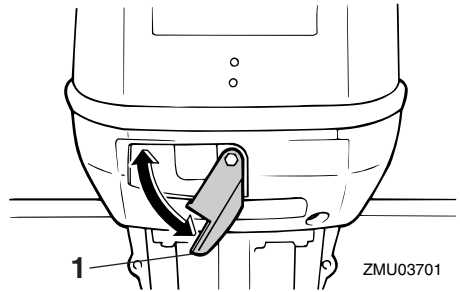

1. Top cowling lock lever(s)

EMU26410

2-pin connector

AC 12 V-40/60/80W power is delivered through this connector. When using it, keep in mind the following points:

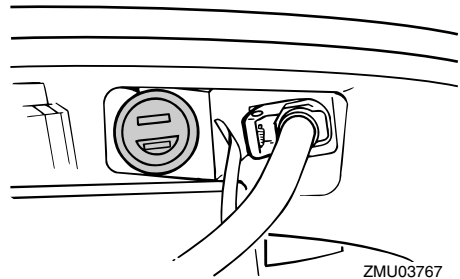

- Use a genuine Yamaha connector.
- Use lighting equipment only.
- Connect lighting equipment directly to the 2-pin connector.
- Capacity of the lighting equipment must be more than 12 V-40/60/80W; otherwise the bulb could burn out.
- When the connector is not in use, place the cap on it.

ECM01000

CAUTION:

Do not connect the 2-pin connector directly to the battery terminals. Otherwise the electric system will be damaged.

Basic components

EMU26420

Battery charging information

If you need to charge the battery, use a genuine charge cable to make the charging circuit.

For details on the cable connections, consult your Yamaha dealer.

NOTE:

- Do not use the 2-pin connector while charging. The battery will not be charged.
- If you need to use lighting equipment while charging the battery, connect it to the battery, not to the 2-pin connector.

EMU26301

Warning indicator

If the engine develops a condition which is cause for warning, the indicator lights up. For details on how to read the warning indicator, see page 15.

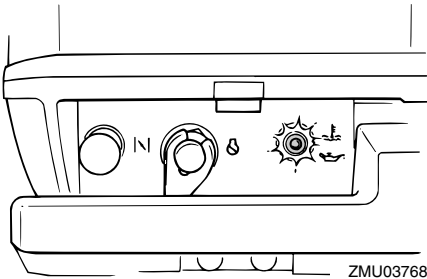

EMU26801

Warning system

ECM00090

CAUTION:

Do not continue to operate the engine if a warning device has activated. Consult your Yamaha dealer if the problem cannot be located and corrected.

EMU26816

Overheat warning

This engine has an overheat warning device. If the engine temperature rises too high, the

warning device will activate.

Activation of warning device

- The engine speed will automatically decrease to about 2000 r/min.
- If equipped with an overheat warning indicator, it will light or blink.

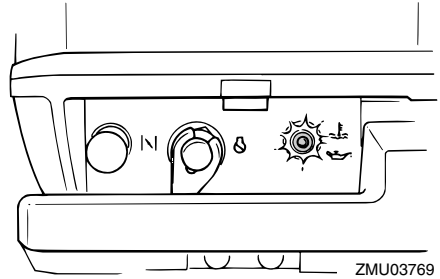

- The buzzer will sound (if equipped on the tiller handle, remote control box, or main switch panel).

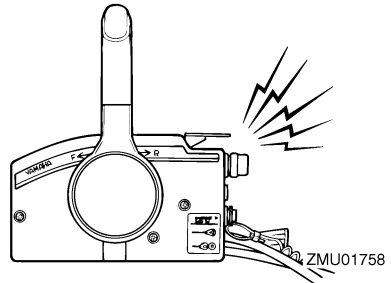

If the warning system has activated, stop the engine and check the cooling water inlet for clogging.

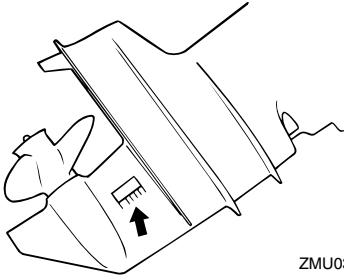

ZMU03026

EMU26846

Oil level warning and oil filter clogging warning

Oil injection models

This engine has an oil level warning system. If the oil level falls below the lower limit, the warning system will activate.

Activation of warning device

- Engine speed will automatically decrease to about 2000 r/min.
- The oil level warning indicator will light or blink.

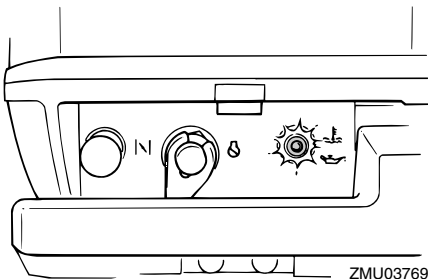

ZMU03769

- The buzzer will sound (if equipped on the tiller handle, remote control box, or main switch panel).

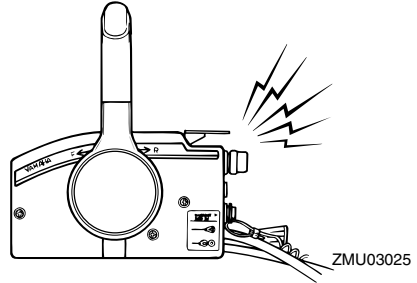

ZMU03025

If the warning system has been activated, stop the engine and check for the cause.

NOTE:

The warning for oil filter clogging is similar to the warnings for low oil level and overheating. To make troubleshooting easier, check for engine overheating first, then oil level, and finally oil filter clogging.

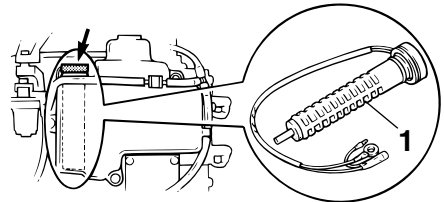

ZMU03707

1. Oil filter

Operation

EMU26901

Installation

ECM00110

CAUTION:

Incorrect engine height or obstructions to smooth water flow (such as the design or condition of the boat, or accessories such as transom ladders or depth finder transducers) can create airborne water spray while the boat is cruising. Severe engine damage may result if the motor is operated continuously in the presence of airborne water spray.

NOTE:

During water testing check the buoyancy of the boat, at rest, with its maximum load. Check that the static water level on the exhaust housing is low enough to prevent water entry into the powerhead, when water rises due to waves when the outboard is not running.

EMU26910

Mounting the outboard motor

EWM00820

WARNING

- Overpowering a boat could cause severe instability. Do not install an outboard motor with more horsepower than the maximum rating on the capacity plate of the boat. If the boat does not have a capacity plate, consult the boat manufacturer.
- The information presented in this section is intended as reference only. It is not possible to provide complete instructions for every possible boat and motor combination. Proper mounting depends in part on experience and the

specific boat and motor combination.

EWM00830

WARNING

Improper mounting of the outboard motor could result in hazardous conditions such as poor handling, loss of control, or fire hazards. Observe the following:

- For permanently mounted models, your dealer or other person experienced in proper rigging should mount the motor. If you are mounting the motor yourself, you should be trained by an experienced person.
- For portable models, your dealer or other person experienced in proper outboard motor mounting should show you how to mount your motor.

Mount the outboard motor on the center line (keel line) of the boat, and ensure that the boat itself is well balanced. Otherwise the boat will be hard to steer. For boats without a keel or which are asymmetrical, consult your dealer.

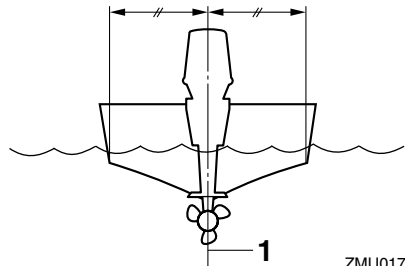

ZMU01760

1. Center line (keel line)

EMU26920

Mounting height

To run your boat at optimum efficiency, the water resistance (drag) of the boat and outboard motor must be made as little as possible. The mounting height of the outboard

motor greatly affects the water resistance. If the mounting height is too high, cavitation tends to occur, thus reducing the propulsion; and if the propeller tips cut the air, the engine speed will rise abnormally and cause the engine to overheat. If the mounting height is too low, the water resistance will increase and thereby reduce engine efficiency. Mount the outboard motor so that the anti-cavitation plate is between the bottom of the boat and a level 25 mm (1 in.) below it.

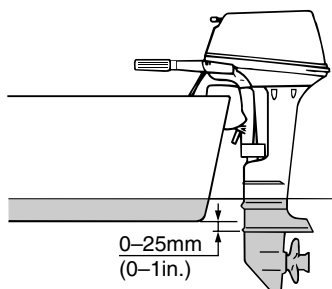

ZMU02011

NOTE:

- The optimum mounting height of the outboard motor is affected by the boat and motor combination and the desired use. Test runs at different heights can help determine the optimum mounting height. Consult your Yamaha dealer or boat manufacturer for further information on determining the proper mounting height.
- For instructions on setting the trim angle of the outboard motor, see page 30.

EMU26970

Clamping the outboard motor

1. Place the outboard motor on the transom so that it is positioned as close to the center as possible. Tighten the transom clamp screws evenly and securely. Occasionally check the clamp screws for tightness during operation of the outboard motor because they could be-

come loose due to engine vibration.

EWM00640



WARNING

Loose clamp screws could allow the outboard motor to fall off or move on the transom. This could cause loss of control and serious injury. Make sure the transom screws are tightened securely. Occasionally check the screws for tightness during operation.

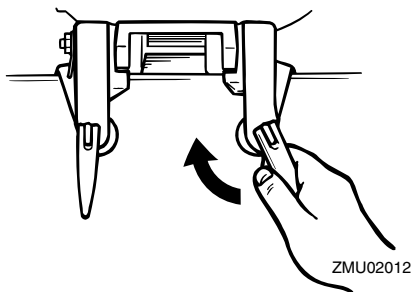

2. If the engine restraint cable attachment is equipped on your engine, an engine restraint cable or chain should be used. Attach one end to the engine restraint cable attachment and the other to a secure mounting point on the boat. Otherwise the engine could be completely lost if it accidentally falls off the transom.

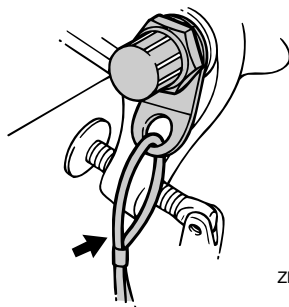

3. Secure the clamp bracket to the transom using the bolts provided with the out-

Operation

board (if packed). For details, consult your Yamaha dealer.

EWM00650

WARNING

Avoid using bolts, nuts or washers other than those contained in the engine packaging. If used, they must be of at least the same quality of material and strength and must be tightened securely. After tightening, test run the engine and check their tightness.

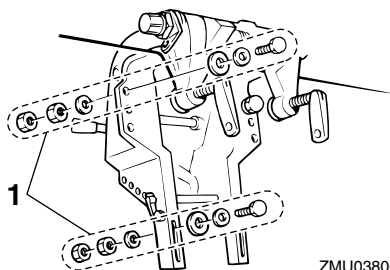

ZMU03806

1. Bolts

EMU27020

Breaking in engine

Your new engine requires a period of break-in to allow mating surfaces of moving parts to wear in evenly. Correct break-in will help ensure proper performance and longer engine life.



ECM00140

CAUTION:



- Failure to follow the break-in procedure could result in reduced engine life or even severe engine damage.
- Premix fuel must be used during break-in in addition to oil in the oil injection system.

EMU27060

Gasoline and engine oil mixing chart (50:1)

	50:1			
	1 L (0.26 US gal, 0.22 Imp gal)	12 L (3.2 US gal, 2.6 Imp gal)	14 L (3.7 US gal, 3.1 Imp gal)	24 L (6.3 US gal, 5.3 Imp gal)
	0.02L (0.02 US qt, 0.02 Imp qt)	0.24 L (0.25 US qt, 0.21 Imp qt)	0.28 L (0.3US qt, 0.25 Imp qt)	0.48 L (0.51 US qt, 0.42 Imp qt)

ZMU02442

1. : Gasoline
2. : Engine oil

ECM00150

CAUTION:

Be sure to mix gasoline and oil completely, otherwise the engine may be damaged.

EMU30311

Procedure for oil injection models

Run the engine under load (in gear with a propeller installed) for 10 hours as follows.

1. First 10 minutes:
Run the engine at the lowest possible speed. A fast idle in neutral is best.
2. Next 50 minutes:
Do not exceed half throttle (approximately 3000 r/min). Vary engine speed occasionally. If you have an easy-planing boat, accelerate at full throttle onto plane, then immediately reduce the throttle to 3000 r/min or less.
3. Next two hours:
Accelerate at full throttle onto plane, then reduce engine speed to three-quarter throttle (approximately 4000 r/min). Vary engine speed occasionally. Run at full throttle for one minute, then allow about 10 minutes of operation at three-quarter throttle or less to let the engine

cool.

4. Remaining seven hours:
Run the engine at any speed. However, avoid operating at full throttle for more than 5 minutes at a time.
5. After the first 10 hours:
Operate the engine normally. Use only straight gasoline in the fuel tank. The Yamaha oil injection system provides proper lubrication for normal operation.

EMU27102

Preoperation checks

EWM00080



If any item in the preoperation check is not working properly, have it inspected and repaired before operating the outboard motor. Otherwise an accident could occur.

ECM00120

CAUTION:

Do not start the engine out of water. Overheating and serious engine damage can occur.

EMU27111

Fuel

- Check to be sure you have plenty of fuel for your trip.
- Make sure there are no fuel leaks or gasoline fumes.
- Check fuel line connections to be sure they are tight (if equipped Yamaha fuel tank or boat tank).
- Be sure the fuel tank is positioned on a secure, flat surface, and that the fuel line is not twisted or flattened, or likely to contact sharp objects (if equipped Yamaha fuel tank or boat tank).

EMU27120

Oil

- Check to be sure you have plenty of oil for

your trip.

EMU27130

Controls

- Check throttle, shift, and steering for proper operation before starting the engine.
- The controls should work smoothly, without binding or unusual free play.
- Look for loose or damaged connections.
- Check operation of the starter and stop switches when the outboard motor is in the water.

EMU27140

Engine

- Check the engine and engine mounting.
- Look for loose or damaged fasteners.
- Check the propeller for damage.

EMU27180

Operation after long period of storage

Oil injection models

When operating the engine after a long period (12 months) of storage, proceed as follows:

1. Use a 50:1 gasoline to oil mixture to start the engine.
2. Start the engine. Leave it idling.

EWM01330



- **Do not touch or remove electrical parts when starting or during operation.**
 - **Keep hands, hair, and clothes away from the flywheel and other rotating parts while the engine is running.**
3. Watch for oil flowing through the oil feed pipes. After any air in the oil lines has been expelled, the oil injection system should supply oil normally. If no oil is flowing after 10 minutes of idling, consult your Yamaha dealer.

Operation

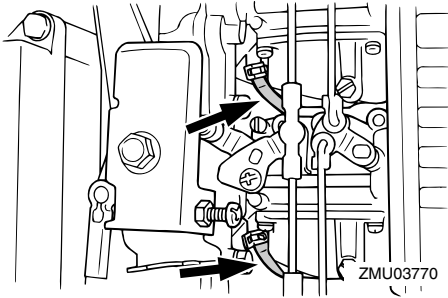

ECM01260

CAUTION:

Be sure to take the above steps when operating the engine after a long period of storage. Otherwise engine seizure could occur.

EMU27233

Filling fuel and engine oil

EMU27242

Filling fuel for portable tank

EWM00060

WARNING

Gasoline and its vapors are highly flammable and explosive. Keep away from sparks, cigarettes, flames, or other sources of ignition.

1. Remove the fuel tank cap.
2. Fill the fuel tank carefully.
3. Close the cap securely after refueling. Wipe up any spilled fuel.

Fuel tank capacity (if equipped Yamaha fuel tank):

25 L (6.60 US gal) (5.50 Imp.gal)

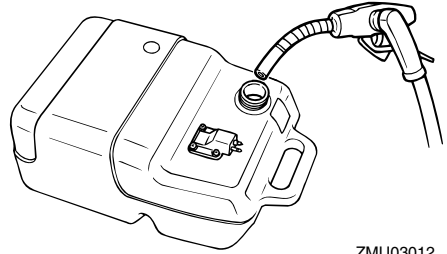

ZMU03012

EMU27301

Filling oil for manual starter model

EWM00530

WARNING

Do not add gasoline into the oil tank. Fire or explosion could result.

This engine uses the Yamaha oil injection system, which provides superior lubrication by ensuring the proper oil ratio for all operating conditions. No fuel premixing is needed. Simply pour gasoline into the fuel tank and oil into the oil tank. Convenient indicator segments indicate the status of the oil supply. For details on reading the indicator segments, see page 23.

To fill the engine oil tank, proceed as follows:

Engine oil tank capacity:
0.9 L (0.95 US qt) (0.79 Imp.qt)

1. Remove the top cowling.
2. Open the oil tank filler cap by pulling the tab.
3. Slowly fill the engine oil into the engine oil tank.

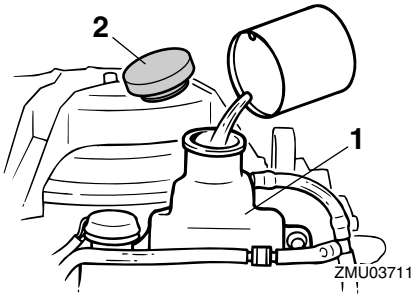

1. Engine oil tank
2. Oil tank filler cap

4. After filling, replace the cap securely.

EMU27311

Filling oil for electric start models

EWM00530



WARNING

Do not add gasoline into the oil tank. Fire or explosion could result.

This engine uses the Yamaha oil injection system, which provides superior lubrication by ensuring the proper oil ratio for all operating conditions. No fuel premixing is needed. Simply pour gasoline into the fuel tank and oil into the oil tank. Convenient indicator segments indicate the status of the oil supply. For details on reading the indicator segments, see page 23.

To fill the engine oil tank, proceed as follows:

Engine oil tank capacity:
0.9 L (0.95 US qt) (0.79 Imp.qt)

1. Turn the oil filler access cap on the top cowling counterclockwise and open it.

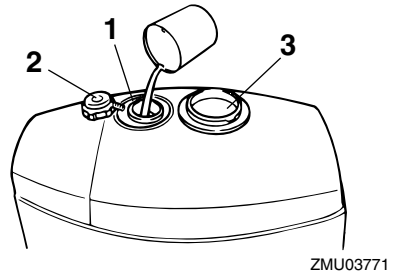

1. Engine oil tank
2. Oil tank filler cap
3. Oil filler access cap

2. Open the oil tank filler cap by pulling the tab on the cap.
3. Slowly pour the engine oil into the engine oil tank.
4. After filling, replace the all caps securely.





Operation

EMU27321

Oil level indicator operation

The various functions of the oil level system are as follows:

EMU27332

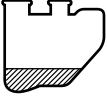
Oil level warning indicator		Engine oil tank	Remarks
OFF	 	 more than 200 cm ³ (0.21 US qt, 0.181 Imp qt)	No refilling necessary.
ON	Red  	 200 cm ³ or less (0.21 US qt, 0.181 Imp qt)	<ul style="list-style-type: none"> ● Buzzer sounds in remote control box and engine speed is limited to about 2000 r/min to help conserve oil. ● Check oil filter for clogging. ● Add oil; see page 21.

EMU27450

Operating engine

EMU27461

Feeding fuel (portable tank)

EWMM00420

WARNING

- Before starting the engine, make sure that the boat is tightly moored and that you can steer clear of any obstructions. Be sure there are no swimmers in the water near you.
- When the air vent screw is loosened, gasoline vapor will be released. Gasoline is highly flammable, and its vapors are flammable and explosive. Refrain from smoking, and keep away from open flames and sparks while loosening the air vent screw.
- This product emits exhaust gases which contain carbon monoxide, a colorless, odorless gas which could cause brain damage or death when inhaled. Symptoms include nausea, dizziness,

and drowsiness. **Keep cockpit and cabin areas well ventilated. Avoid blocking exhaust outlets.**

1. If there is an air vent screw on the fuel tank cap, loosen it 2 or 3 turns.

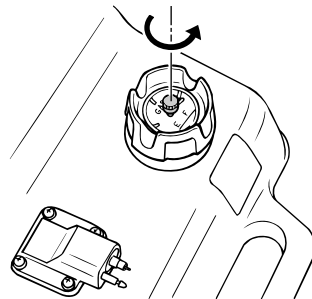

ZMU02022

2. If there is a fuel joint on the motor, firmly connect the fuel line to the joint. Then firmly connect the other end of the fuel line to the joint on the fuel tank.

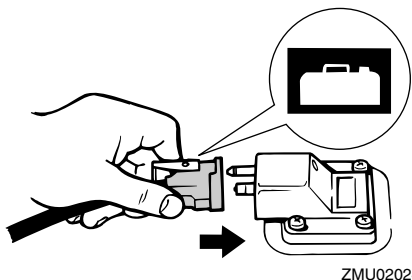
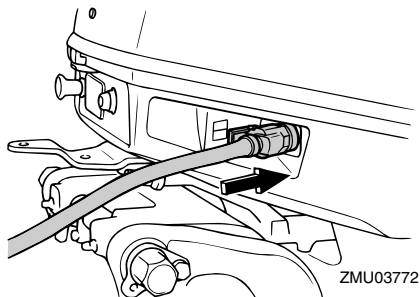

3. If a steering friction adjuster is provided on your outboard motor, securely attach the fuel line to the fuel line clamp.

NOTE:

During engine operation place the tank horizontally, otherwise fuel cannot be drawn from the fuel tank.

4. Squeeze the primer pump with the outlet end up until you feel it become firm.

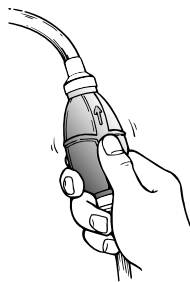

EMU27490

Starting engine

EMU27505

Manual start models (tiller control)

1. Place the gear shift lever in neutral.

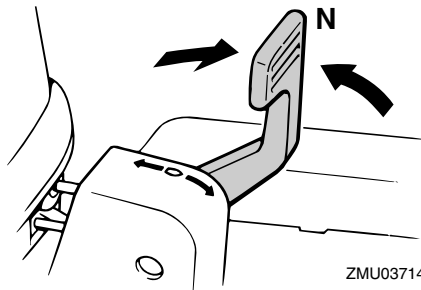

NOTE:

The start-in-gear protection device prevents the engine from starting except when in neutral.

2. Attach the engine stop switch lanyard to a secure place on your clothing, or your arm or leg. Then install the lock plate on the other end of the lanyard into the engine stop switch.

EWM00120

WARNING

- Attach the engine stop switch lanyard to a secure place on your clothing, or your arm or leg while operating.
- Do not attach the lanyard to clothing that could tear loose. Do not route the lanyard where it could become entangled, preventing it from functioning.
- Avoid accidentally pulling the lanyard during normal operation. Loss of engine power means the loss of most steering control. Also, without engine power, the boat could slow rapidly. This could cause people and objects in the boat to be thrown forward.

Operation

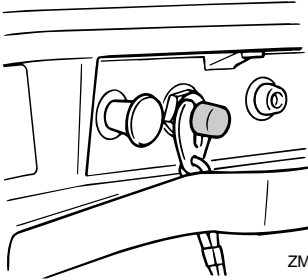

ZMU03773

3. Place the throttle grip in the “START” (start) position.

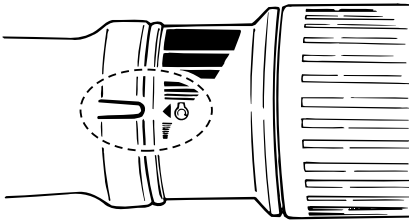

ZMU02954

4. Pull out / turn the choke knob fully. After the engine starts, replace / return the knob to the home position.

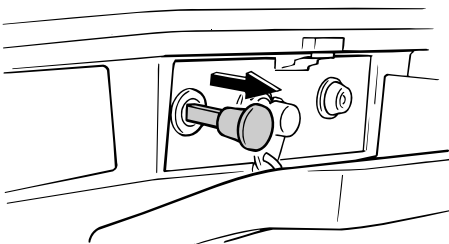

ZMU03774

NOTE:

- It is not necessary to use the choke when starting a warm engine.
- If the choke knob is left in the “START” (start) position while the engine is running,

the engine will run poorly or stall.

5. Pull the manual starter handle slowly until you feel resistance. Then give a strong pull straight out to crank and start the engine. Repeat if necessary.

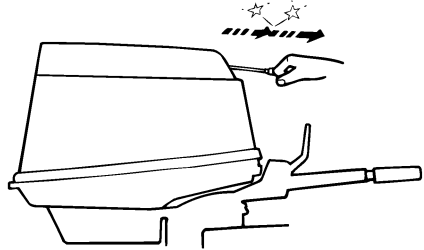

ZMU02735

6. After the engine starts, slowly return the manual starter handle to its original position before releasing it.
7. Slowly return the throttle grip to the fully closed position.

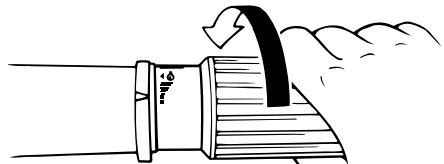

ZMU02030

NOTE:

- When the engine is cold, it needs to be warmed up. For further information, see page 27.
- If the engine does not start on the first try, repeat the procedure. If the engine fails to start after 4 or 5 tries, open the throttle a small amount (between 1/8 and 1/4) and try again. Also if the engine is warm and fails to start, open the throttle a same

amount and try to start the engine again. If the engine still fails to start, see page 60.

EMU27642

Electric start / remote control models

1. Place the remote control lever in neutral.

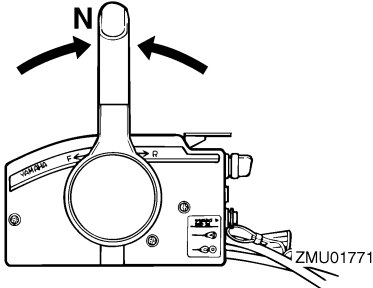

NOTE:

The start-in-gear protection device prevents the engine from starting except when in neutral.

2. Attach the engine stop switch lanyard to a secure place on your clothing, or your arm or leg. Then install the lock plate on the other end of the lanyard into the engine stop switch.

EWM00120

WARNING

- Attach the engine stop switch lanyard to a secure place on your clothing, or your arm or leg while operating.
- Do not attach the lanyard to clothing that could tear loose. Do not route the lanyard where it could become entangled, preventing it from functioning.
- Avoid accidentally pulling the lanyard during normal operation. Loss of engine power means the loss of most steering control. Also, without engine power, the boat could slow rapidly. This could cause people and objects in the boat to be thrown forward.

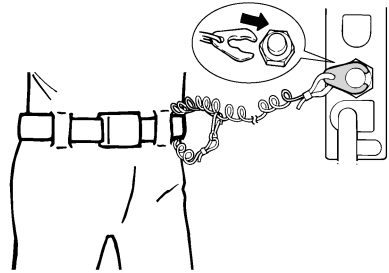

ZMU01772

3. Turn the main switch to "ON" (on).

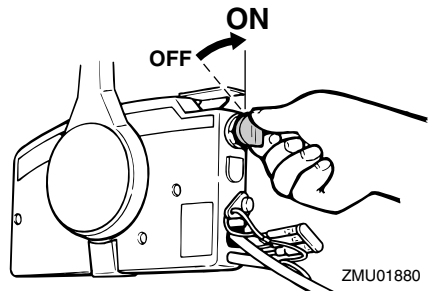

4. Open the throttle slightly without shifting using the neutral throttle lever or free accelerator. You may need to change the throttle opening slightly depending on engine temperature. After the engine starts, return the throttle to the original position.

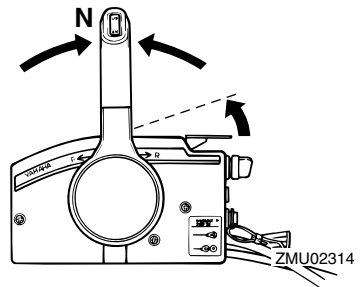

NOTE:

- On remote controls equipped with a neu-

Operation

tral throttle lever, a good starting point is to lift the lever just until you feel resistance, then lift slightly more.

- The neutral throttle lever or free accelerator can only be used when the remote control lever is in neutral.
-
5. Press in and hold the main switch to operate the remote choke system. The remote choke switch automatically returns to its normal position when you release your hand. Therefore keep the switch pressed in.

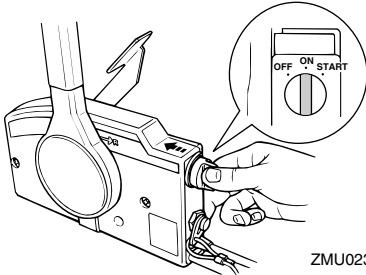

ZMU02315

NOTE:

- It is not necessary to use the choke when starting a warm engine.
 - Push in the main switch fully, or the remote choke system will not operate.
-
6. Turn the main switch to “START” (start), and hold it for a maximum of 5 seconds.

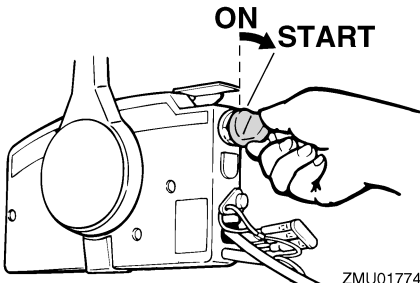

ZMU01774

7. Immediately after the engine starts, re-

lease the main switch and allow it to return to “ON” (on).

ECM00191

CAUTION:

- **Never turn the main switch to “START” (start) while the engine is running.**
- **Do not keep the starter motor turning for more than 5 seconds. If the starter motor is turned continuously for more than 5 seconds, the battery will be quickly discharged, thus making it impossible to start the engine. The starter can also be damaged. If the engine will not start after 5 seconds of cranking, return the main switch to “ON” (on), wait 10 seconds, then crank the engine again.**

EMU27670

Warming up engine

EMU27681

Choke start models

1. After starting the engine, allow it to idle for 3 minutes to warm up. Failure to do so will shorten engine life. Gradually return the choke knob to its home position as the engine warms up.
2. Check for a steady flow of water from the cooling water pilot hole.

ECM00511

CAUTION:

A continuous flow of water from the cooling water pilot hole shows that the water pump is pumping water through the cooling passages. If water is not flowing out of the hole at all times while the engine is running, overheating and serious damage could occur. Stop the engine and check whether the cooling water inlet on the lower case or the cooling water pilot hole is blocked. Consult your Yamaha dealer if the problem cannot be located

and corrected.

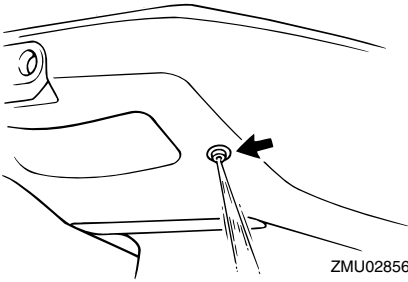

EMU27740

Shifting

EWM00180

WARNING

Before shifting, make sure there are no swimmers or obstacles in the water near you.

ECM00220

CAUTION:

To change the boat direction or shifting position from forward to reverse or vice-versa, first close the throttle so that the engine idles (or runs at low speeds).

EMU27764

Forward (tiller handle and remote control models)

Tiller handle models

1. Place the throttle grip in the fully closed position.

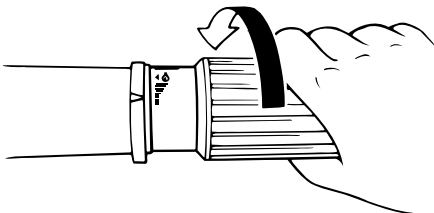

ZMU02030

2. Move the gear shift lever quickly and firmly from neutral to forward.

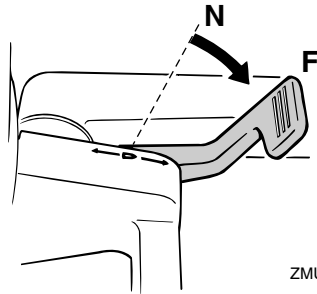

ZMU03718

Remote control models

1. Pull up the neutral interlock trigger (if equipped) and move the remote control lever quickly and firmly from neutral to forward.

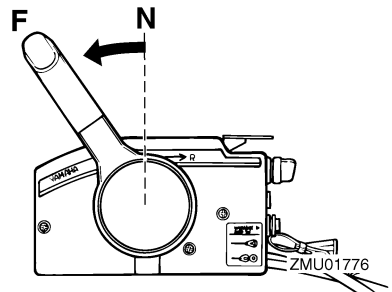

ZMU01776

EMU27785

Reverse (automatic reverse lock and power trim and tilt models)

EWM00190

WARNING

When operating in reverse, go slowly. Do not open the throttle more than half. Otherwise the boat could become unstable, which could result in loss of control and an accident.

Tiller handle models

1. Place the throttle grip in the fully closed position.
2. Move the gear shift lever quickly and

Operation

firmly from neutral to reverse.

Remote control models

1. Pull up the neutral interlock trigger (if equipped) and move the remote control lever quickly and firmly from neutral to reverse.

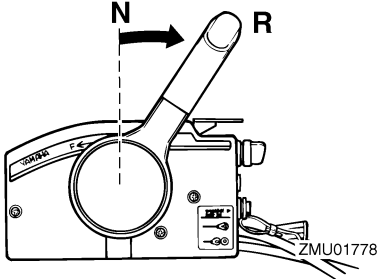

EMU27796

Reverse (manual tilt and hydro tilt models)

EWM00190



When operating in reverse, go slowly. Do not open the throttle more than half. Otherwise the boat could become unstable, which could result in loss of control and an accident.

Tiller handle models

1. Place the throttle grip in the fully closed position.

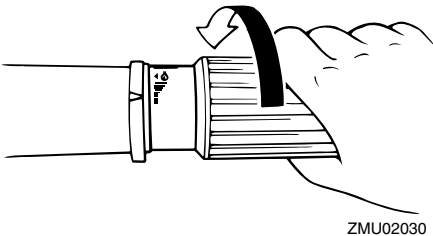

2. On models equipped with a tilt lock lever, check that it is in the lock/down po-

sition.

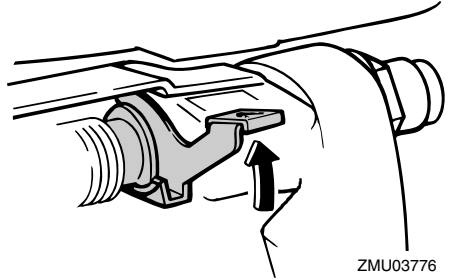

3. Move the gear shift lever quickly and firmly from neutral to reverse.

Remote control models

1. Check that the tilt lock lever is in the lock position.

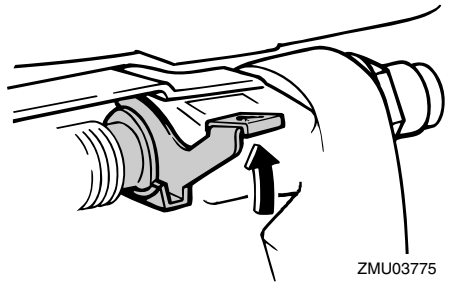

2. Pull up the neutral interlock trigger (if equipped) and move the remote control lever quickly and firmly from neutral to reverse.

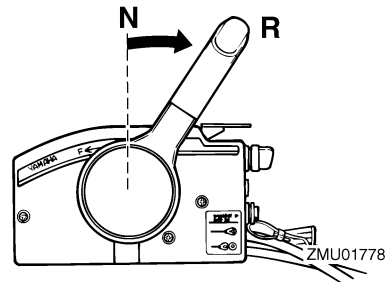

EMU27820

Stopping engine

Before stopping the engine, first let it cool off for a few minutes at idle or low speed. Stopping the engine immediately after operating at high speed is not recommended.

EMU27844

Procedure

1. Push and hold the engine stop button or turn the main switch to "OFF" (off).

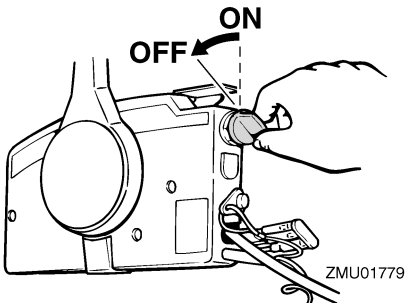
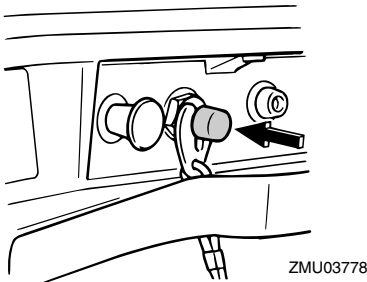

2. After stopping the engine, disconnect the fuel line if there is a fuel joint on the outboard motor.

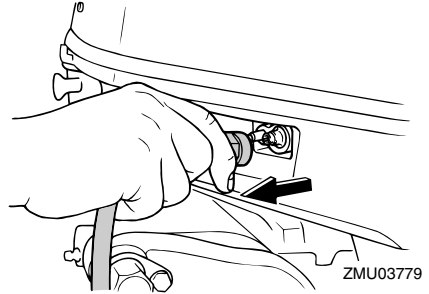

3. Tighten the air vent screw on the fuel tank cap (if equipped).

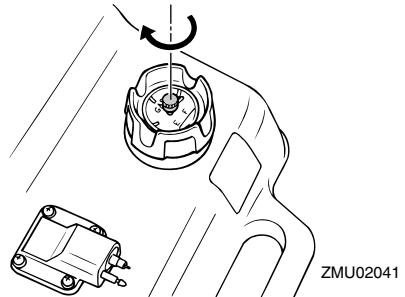

4. Remove the key if the boat will be left unattended.

NOTE:

The engine can also be stopped by pulling the lanyard and removing the lock plate from the engine stop switch, then turning the main switch to "OFF" (off).

EMU27861

Trimming outboard motor

The trim angle of the outboard motor helps determine the position of the bow of the boat in the water. Correct trim angle will help improve performance and fuel economy while reducing strain on the engine. Correct trim angle depends upon the combination of boat, engine, and propeller. Correct trim is also affected by variables such as the load in

Operation

the boat, sea conditions, and running speed.

EWM00740

WARNING

Excessive trim for the operating conditions (either trim up or trim down) can cause boat instability and can make steering the boat more difficult. This increases the possibility of an accident. If the boat begins to feel unstable or is hard to steer, slow down and/or readjust the trim angle.

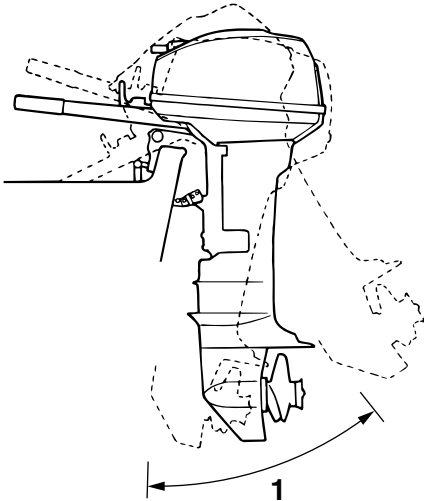

ZMU02858

1. Trim operating angle

EMU27872

Adjusting trim angle for manual tilt models

There are 4 or 5 holes provided in the clamp bracket to adjust the outboard motor trim angle.

1. Stop the engine.
2. Tilt the outboard motor up, and then re-

move the trim rod from the clamp bracket.

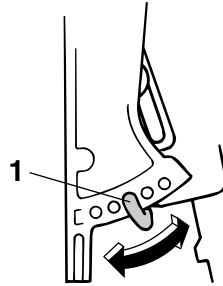

ZMU03780

1. Trim rod

3. Reposition the rod in the desired hole. To raise the bow ("trim-out"), move the rod away from the transom.

To lower the bow ("trim-in"), move the rod toward the transom.

Make test runs with the trim set to different angles to find the position that works best for your boat and operating conditions.

EWM00400

WARNING

- Stop the engine before adjusting the trim angle.
- Use care to avoid being pinched when removing or installing the rod.
- Use caution when trying a trim position for the first time. Increase speed gradually and watch for any signs of instability or control problems. Improper trim angle can cause loss of control.

NOTE:

The outboard motor trim angle can be changed approximately 4 degrees by shifting the trim rod one hole.

EMU27902

Adjusting trim angle (power tilt models)

EWMO0751

WARNING

- Be sure all people are clear of the outboard motor when adjusting the tilt angle, also be careful not to pinch any body parts between the drive unit and clamp bracket.
- Use caution when trying a trim position for the first time. Increase speed gradually and watch for any signs of instability or control problems. Improper trim angle can cause loss of control.
- If equipped with a power trim and tilt switch located on the bottom cowling, use the switch only when the boat is at a complete stop with the engine off. Do not adjust the trim angle with this switch while the boat is moving.

Tilt the engine to the desired angle using the power tilt switch.

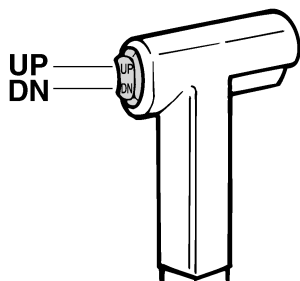

NOTE:

Stay within the trim operating angle when trimming the outboard motor using the power tilt system.

To raise the bow (“trim-out”), tilt the engine up.

To lower the bow (“trim-in”), tilt the engine

down.

Make test runs with the trim set to different angles to find the position that works best for your boat and operating conditions.

EMU27911

Adjusting boat trim

When the boat is on plane, a bow-up attitude results in less drag, greater stability and efficiency. This is generally when the keel line of the boat is up about 3 to 5 degrees. With the bow up, the boat may have a greater tendency to steer to one side or the other. Compensate for this as you steer. The trim tab can also be adjusted to help offset this effect. When the bow of the boat is down, it is easier to accelerate from a standing start onto plane.

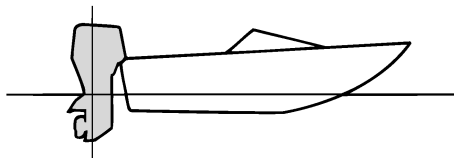

ZMU01784

Bow Up

Too much trim-out puts the bow of the boat too high in the water. Performance and economy are decreased because the hull of the boat is pushing the water and there is more air drag. Excessive trim-out can also cause the propeller to ventilate, which reduces performance further, and the boat may “porpoise” (hop in the water), which could throw the operator and passengers overboard.

Operation

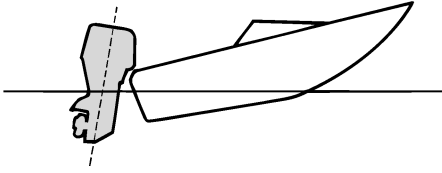

ZMU01785

Bow Down

Too much trim-in causes the boat to “plow” through the water, decreasing fuel economy and making it hard to increase speed. Operating with excessive trim-in at higher speeds also makes the boat unstable. Resistance at the bow is greatly increased, heightening the danger of “bow steering” and making operation difficult and dangerous.

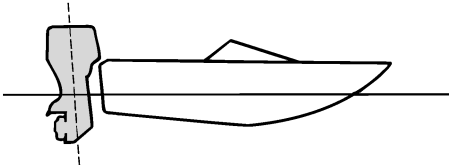

ZMU01786

NOTE:

Depending on the type of boat, the outboard motor trim angle may have little effect on the trim of the boat when operating.

EMU27933

Tilting up and down

If the engine will be stopped for some time or if the boat is moored in shallows, the outboard motor should be tilted up to protect the propeller and casing from damage by collision with obstructions, and also to reduce

salt corrosion.

EWM00220

WARNING

Be sure all people are clear of the outboard motor when tilting up and down, also be careful not to pinch any body parts between the drive unit and engine bracket.

EWM00250

WARNING

Leaking fuel is a fire hazard. If there is a fuel joint on the outboard motor, disconnect the fuel line or close the fuel cock if the engine will be tilted for more than a few minutes. Otherwise fuel may leak.

ECM00241

CAUTION:

- Before tilting the outboard motor, stop the engine by following the procedure on page 30. Never tilt the outboard motor while the engine is running. Severe damage from overheating can result.
- Do not tilt up the engine by pushing the tiller handle (if equipped) because this could break the handle.

EMU27953

Procedure for tilting up (manual tilt models)

1. Place the gear shift lever in neutral.

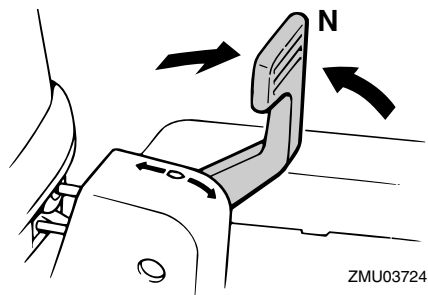

ZMU03724

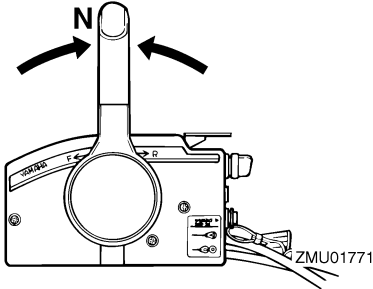

2. Disconnect the fuel line if a fuel joint is provided on the outboard motor.

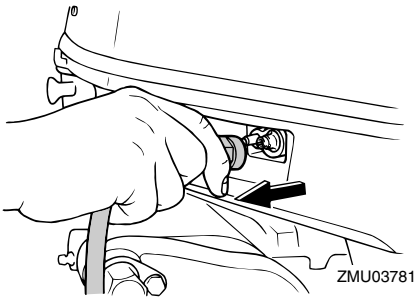

3. Place the tilt lock lever in the release position.

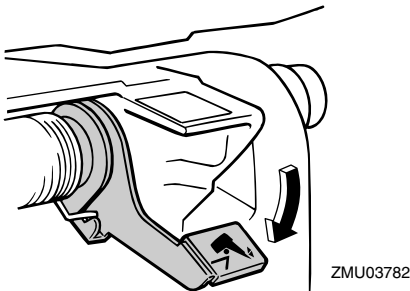

4. Hold the rear of the top cowling with one hand, tilt the engine up, and turn the tilt support lever to the lock position and support the engine.

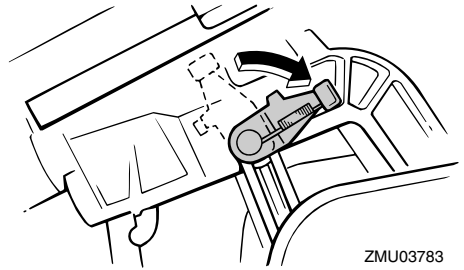

EMU28006

Procedure for tilting up

Power trim and tilt models / power tilt models

1. Place the remote control lever / gear shift lever in neutral.

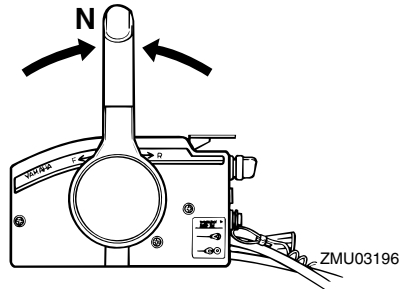

2. Disconnect the fuel line from the outboard motor or close the fuel cock.

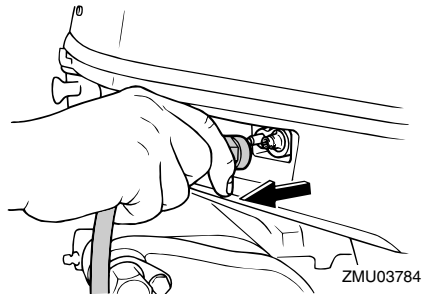

3. Press the power trim and tilt switch "UP" (up) until the outboard motor has tilted up completely.

Operation

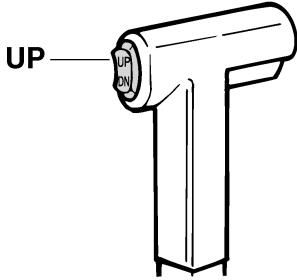

ZMU01787

4. Push the tilt support knob into the clamp bracket or pull the tilt support lever toward you to support the engine.

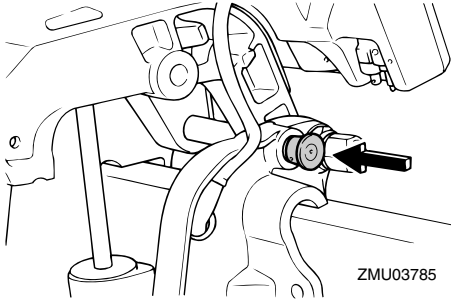

EWM00260

WARNING

After tilting the outboard motor, be sure to support it with the tilt support knob or tilt support lever. Otherwise the outboard motor could fall back down suddenly if oil in the power trim and tilt unit loses pressure.

5. Models equipped with trim rods: Once the outboard motor is supported with the tilt support lever, press the power trim and tilt switch / power tilt switch "DN" (down) to retract the trim rods.

ECM00250

CAUTION:

Be sure to retract the trim rods completely during mooring. This protects the rods

from marine growth and corrosion which could damage the power trim and tilt mechanism.

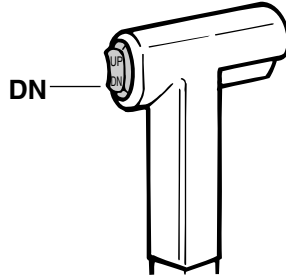

ZMU01936

EMU28041

Procedure for tilting down (manual and hydro tilt models)

1. Release the tilt lock lever.

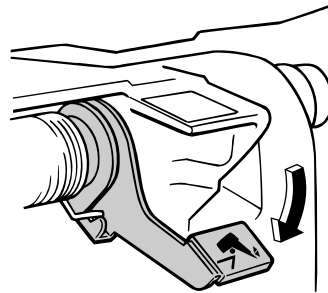

2. Hold the rear of the top cowling with one hand, tilt the outboard motor up slightly and pull out the tilt support knob or return the tilt support lever.

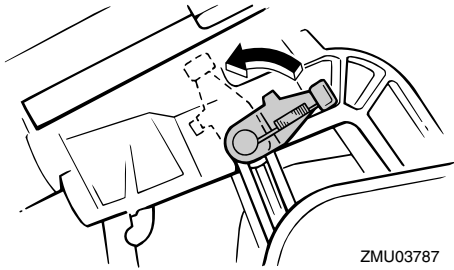

ZMU03787

3. Slowly tilt the outboard motor down.
4. Place the tilt lock lever in the lock position.

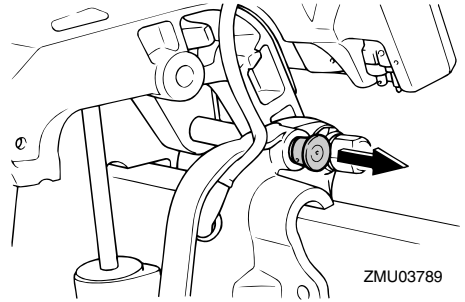

ZMU03789

3. Push the power trim and tilt switch / power tilt switch "DN" (down) to lower the outboard motor to the desired position.

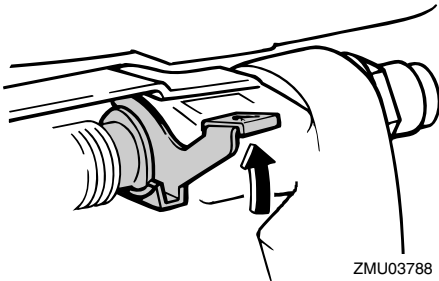

ZMU03788

EMU28054

Procedure for tilting down

Power trim and tilt models / power tilt models

1. Push the power trim and tilt switch / power tilt switch "UP" (up) until the outboard motor is supported by the tilt rod and the tilt support lever / tilt support knob becomes free.
2. Release the tilt support lever or pull out the tilt support knob.

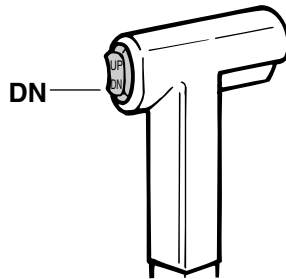

ZMU01936

EMU28060

Cruising in shallow water

The outboard motor can be tilted up partially to allow operation in shallow water.

EMU28071

Cruising in shallow water (manual tilt models)

EWM00710

⚠ WARNING

- Place the gear shift in neutral before using the shallow water cruising system.
- Run the boat at the lowest possible speed when using the shallow water cruising system. The tilt lock mechanism does not work while the shallow water cruising system is being used. Hitting an underwater obstacle could cause the outboard motor to lift out of

Operation

the water, resulting in loss of control.

- Do not rotate the outboard motor 180° and operate the boat in reverse. Place the gear shift in reverse to operate the boat in reverse.
- Use extra care when operating in reverse. Too much reverse thrust can cause the outboard motor to lift out of the water, increasing the chance of accident and personal injury.
- Return the outboard motor to its normal position as soon as the boat is back in deeper water.

ECM00260

CAUTION:

Do not tilt the outboard motor up so that the cooling water inlet on the lower unit is above the surface of the water when setting up for and cruising in shallow water. Otherwise severe damage from overheating can result.

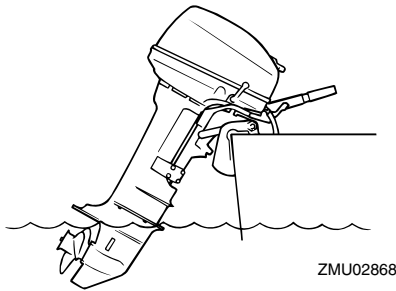

ZMU02868

EMU28141

Procedure

1. Place the gear shift lever in neutral.

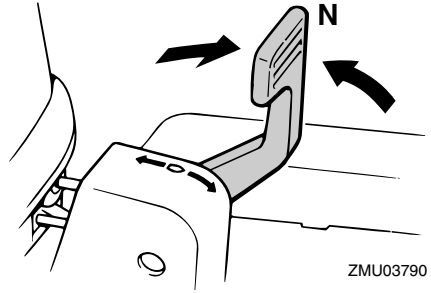

ZMU03790

2. Push the shallow water lever down to the release position.

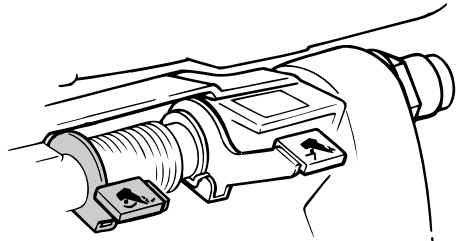

ZMU03791

3. To set the outboard motor in a partially tilted position, slightly tilt the outboard motor up until the plate turns completely.

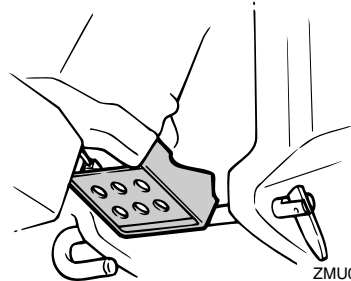

ZMU03792

4. To return the outboard motor to the normal running position, place the gear shift lever in neutral, then slightly tilt the outboard motor up. Set the tilt lock lever and shallow water lever to the lock position and slowly tilt the outboard motor

down.

EMU28090

Power trim and tilt models / power tilt models

The outboard motor can be tilted up partially to allow operation in shallow water.

EWMO0660

WARNING

- Place the gear shift in neutral before setting up for shallow water cruising.
- Return the outboard motor to its normal position as soon as the boat is back in deeper water.

ECM00260

CAUTION:

Do not tilt the outboard motor up so that the cooling water inlet on the lower unit is above the surface of the water when setting up for and cruising in shallow water. Otherwise severe damage from overheating can result.

EMU28185

Procedure for power trim and tilt / power tilt models

1. Place the remote control lever / gear shift lever in neutral.

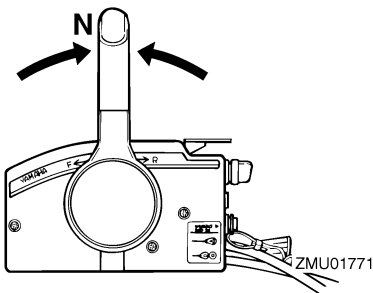

2. Slightly tilt the outboard motor up to the desired position using the power trim and tilt switch / power tilt switch.

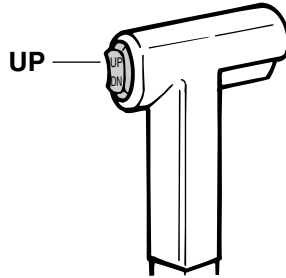

ZMU01935

3. To return the outboard motor to the normal running position, press the power trim and tilt switch / power tilt switch and slowly tilt the outboard motor down.

EMU28192

Cruising in other conditions

Cruising in salt water

After operating in salt water, flush the cooling water passages with fresh water to prevent them from becoming clogged with salt deposits.

NOTE:

For cooling system flushing instructions, see page 40.

Cruising in turbid water

Yamaha strongly recommends that you use the optional chromium-plated water pump kit (not available for some models) if you use the outboard motor in turbid or muddy water conditions.

Maintenance

EMU31480

Specifications

NOTE:

“(AL)” stated in the specification data below represents the numerical value for the aluminum propeller installed.

Likewise, “(SUS)” represents the value for stainless steel propeller installed and “(PL)” for plastic propeller installed.

EMU28218

Dimension:

Overall length:

- 30DEO 662 mm (26.1 in)
- 30DETO 662 mm (26.1 in)
- 30DMHO 993 mm (39.1 in)

Overall width:

- 30DEO 307 mm (12.1 in)
- 30DETO 307 mm (12.1 in)
- 30DMHO 360 mm (14.2 in)

Overall height S:

- 30DEO 1140 mm (44.9 in)
- 30DMHO 1158 mm (45.6 in)

Overall height L:

- 30DEO 1261 mm (49.6 in)
- 30DETO 1261 mm (49.6 in)
- 30DMHO 1279 mm (50.4 in)

Transom height S:

- 30DEO 424 mm (16.7 in)
- 30DMHO 424 mm (16.7 in)

Transom height L:

- 545 mm (21.5 in)

Weight (AL) S:

- 30DEO 60.0 kg (132 lb)
- 30DMHO 60.0 kg (132 lb)

Weight (AL) L:

- 30DEO 62.0 kg (137 lb)
- 30DETO 66.0 kg (146 lb)
- 30DMHO 62.0 kg (137 lb)

Performance:

Full throttle operating range:

4500–5500 r/min

Maximum output:

22.1 kW@5000 r/min (30 HP@5000 r/min)

Idling speed (in neutral):

- 30DEO 750 ±50 r/min
- 30DETO 1050 ±50 r/min
- 30DMHO 750 ±50 r/min

Engine:

Type:

2-stroke L

Displacement:

496.0 cm³ (30.27 cu.in)

Bore × stroke:

59.5 × 59.5 mm (2.34 × 2.34 in)

Ignition system:

CDI

Spark plug with resistor (NGK):

BR7HS-10

Spark plug gap:

0.9–1.0 mm (0.035–0.039 in)

Control system:

- 30DEO Remote control
- 30DETO Remote control
- 30DMHO Tiller

Starting system:

- 30DEO Electric
- 30DETO Electric
- 30DMHO Manual

Starting carburetion system:

Choke valve

Min. cold cranking amps (CCA/EN):

- 30DEO 347.0 A
- 30DETO 347.0 A

Min. rated capacity (20HR/IEC):

- 30DEO 40.0 Ah
- 30DETO 40.0 Ah

Alternator output:

30DMHO 80 W

Alternator output for battery DC:

30DEO 6.0 A

30DETO 6.0 A

Drive unit:

Gear positions:

Forward-neutral-reverse

Gear ratio:

1.85 (24/13)

Trim and tilt system:

30DEO Manual tilt

30DETO Power trim and tilt

30DMHO Manual tilt

Propeller mark:

F

Fuel and oil:

Recommended fuel:

Regular unleaded gasoline

Min. research octane:

90

Fuel tank capacity:

25 L (6.60 US gal) (5.50 Imp.gal)

Recommended engine oil:

YAMALUBE 2-stroke outboard motor oil

Lubrication:

Oil injection

Engine oil tank capacity:

0.9 L (0.95 US qt) (0.79 Imp.qt)

Recommended gear oil:

Hypoid gear oil SAE#90

Gear oil quantity:

200.0 cm³ (6.76 US oz) (7.05 Imp.oz)

Tightening torque for engine:

Spark plug:

25.0 Nm (18.4 ft-lb) (2.55 kgf-m)

Propeller nut:

35.0 Nm (25.8 ft-lb) (3.57 kgf-m)

EMJ28222

Transporting and storing outboard motor

EWM00690



- Leaking fuel is a fire hazard. When

transporting and storing the outboard motor, close the air vent screw and fuel cock to prevent fuel from leaking.

- USE CARE when transporting fuel tank, whether in a boat or car.
- DO NOT fill fuel container to maximum capacity. Gasoline will expand considerably as it warms up and can build up pressure in the fuel container. This can cause fuel leakage and a potential fire hazard.

EWM00700



Never get under the lower unit while it is tilted, even if a motor support bar is used. Severe injury could occur if the outboard motor accidentally falls.

ECM00660



Do not use the tilt support lever or knob when trailering the boat. The outboard motor could shake loose from the tilt support and fall. If the motor cannot be trailered in the normal running position, use an additional support device to secure it in the tilt position.

The outboard motor should be trailered and stored in the normal running position. If there is insufficient road clearance in this position, then trailer the outboard motor in the tilt position using a motor support device such as a transom saver bar. Consult your Yamaha dealer for further details.

EMU28235

Clamp screw mounting models

When transporting or storing the outboard motor while removed from a boat, keep the outboard motor in the attitude shown.

Maintenance

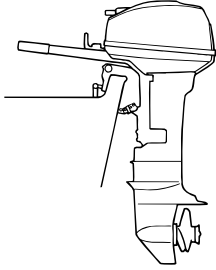

ZMU02870

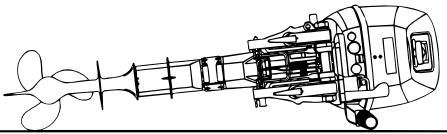

ZMU02869

NOTE:

Place a towel or something similar under the outboard motor to protect it from damage.

EMU30272

Storing outboard motor

When storing your Yamaha outboard motor for prolonged periods of time (2 months or longer), several important procedures must be performed to prevent excessive damage. It is advisable to have your outboard motor serviced by an authorized Yamaha dealer prior to storage. However, you, the owner, with a minimum of tools, can perform the following procedures.

ECM01411

CAUTION:

- Do not place the outboard motor on its side before the cooling water has drained from it completely, otherwise water may enter the cylinder through

the exhaust port and cause engine trouble.

- Store the outboard motor in a dry, well-ventilated place, not in direct sunlight.

EMU28302

Procedure

EMU28332

Flushing in a test tank

ECM00300

CAUTION:

Do not run the engine without supplying it with cooling water. Either the engine water pump will be damaged or the engine will be damaged from overheating. Before starting the engine, be sure to supply water to the cooling water passages.

1. Wash the outboard motor body using fresh water. For further information, see page 44.
2. Disconnect the fuel line from the motor or shut off the fuel cock, if equipped.
3. Remove the engine top cowling and silencer cover. Remove the propeller.
4. Install the outboard motor on the test tank. Fill the tank with fresh water to above the level of the anti-cavitation plate.

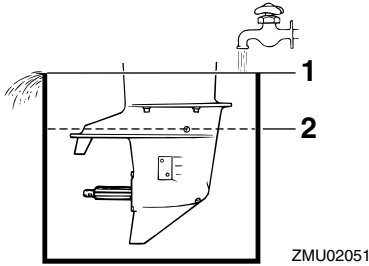

1. Water surface
2. Lowest water level

ECM00290

CAUTION:

If the fresh water level is below the level of the anti-cavitation plate, or if the water supply is insufficient, engine seizure may occur.

5. Cooling system flushing is essential to prevent the cooling system from clogging up with salt, sand, or dirt. In addition, fogging/lubricating of the engine is mandatory to prevent excessive engine damage due to rust. Perform the flushing and fogging at the same time.

EWM00090

WARNING

- Do not touch or remove electrical parts when starting or during operation.
- Keep hands, hair, and clothes away from the flywheel and other rotating parts while the engine is running.

6. Run the engine at a fast idle for a few minutes in neutral position.
7. Just prior to turning off the engine, quickly spray "Fogging Oil" alternately into each carburetor or the fogging hole of the silencer cover, if equipped. When properly done, the engine will smoke ex-

cessively and almost stall.

8. Remove the outboard motor from the test tank.
9. Install the silencer cover/cap of fogging hole and top cowling.
10. If the "Fogging Oil" is not available, run the engine at a fast idle until the fuel system becomes empty and the engine stops.
11. Drain the cooling water completely out of the motor. Clean the body thoroughly.
12. If the "Fogging Oil" is not available, remove the spark plug(s). Pour a teaspoonful of clean engine oil into each cylinder. Crank several times manually. Replace the spark plug(s).
13. Drain the fuel from the fuel tank.

NOTE:

Store the fuel tank in a dry, well-ventilated place, not in direct sunlight.

EMU28343

Flushing with the water flush plug

1. Wash the outboard motor body using fresh water. For further information, see page 44.

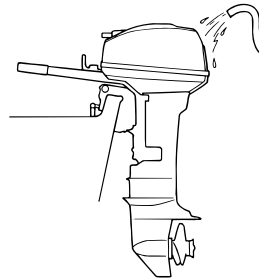

2. Disconnect the fuel line from the motor or shut off the fuel cock, if equipped.
3. Remove the engine top cowling and silencer cover. Remove the propeller.
4. Remove the screw located beside the "WASH" (wash) mark on the lower case.

Maintenance

Install the water flush plug and connect it to a fresh water tap. Cover the cooling water inlet with tape.

ECM00300

CAUTION:

Do not run the engine without supplying it with cooling water. Either the engine water pump will be damaged or the engine will be damaged from overheating. Before starting the engine, be sure to supply water to the cooling water passages.

ECM00310

CAUTION:

Avoid running the outboard motor at high speed while on the flushing attachment, otherwise overheating could occur.

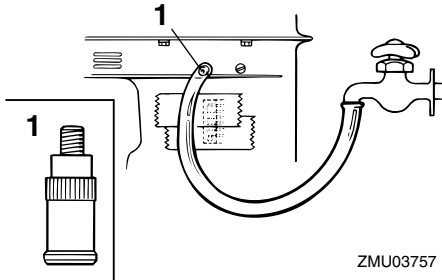

1. Water flush plug

5. Cooling system flushing is essential to prevent the cooling system from clogging up with salt, sand, or dirt. In addition, fogging/lubricating of the engine is mandatory to prevent excessive engine damage due to rust. Perform the flushing and fogging at the same time.

EWM00090

WARNING

- Do not touch or remove electrical parts

when starting or during operation.

- Keep hands, hair, and clothes away from the flywheel and other rotating parts while the engine is running.
-

6. Run the engine at a fast idle for a few minutes in neutral position.
7. Just prior to turning off the engine, quickly spray "Fogging Oil" alternately into each carburetor or the fogging hole of the silencer cover, if equipped. When properly done, the engine will smoke excessively and almost stall.
8. Remove the water flush plug and the tape.
9. Install the silencer cover/cap of fogging hole and top cowling.
10. If the "Fogging Oil" is not available, run the engine at a fast idle until the fuel system becomes empty and the engine stops.
11. Drain the cooling water completely out of the motor. Clean the body thoroughly.
12. If the "Fogging Oil" is not available, remove the spark plug(s). Pour a teaspoonful of clean engine oil into each cylinder. Crank several times manually. Replace the spark plug(s).
13. Drain the fuel from the fuel tank.

NOTE:

Store the fuel tank in a dry, well-ventilated place, not in direct sunlight.

EMU28410

Lubrication (oil injection models)

1. Grease the spark plug threads and install the spark plug(s) and torque to proper specification. For information on spark plug installation, see page 49.
2. Fill the oil tanks. This prevents the formation of condensation. For models with a remote oil tank, it may be necessary to

manually override the control unit to completely fill the engine oil tank.

3. Change the gear oil. For instructions, see page 55. Inspect the oil for the presence of water which indicates a leaky seal. Seal replacement should be performed by an authorized Yamaha dealer prior to use.
4. Grease all grease fittings. For further details, see page 48.

EMU28430

Battery care

EWM00330



Battery electrolytic fluid is dangerous; it contains sulfuric acid and therefore is poisonous and highly caustic.

Always follow these preventive measures:

- Avoid bodily contact with electrolytic fluid as it can cause severe burns or permanent eye injury.
- Wear protective eye gear when handling or working near batteries.

Antidote (EXTERNAL):

- SKIN - Flush with water.
- EYES - Flush with water for 15 minutes and get immediate medical attention.

Antidote (INTERNAL):

- Drink large quantities of water or milk followed by milk of magnesia, beaten egg, or vegetable oil. Get immediate medical attention.

Batteries also generate explosive hydrogen gas; therefore, you should always follow these preventive measures:

- Charge batteries in a well-ventilated area.
- Keep batteries away from fire, sparks, or open flames (for example: welding equipment, lighted cigarettes, and so

on.)

- **DO NOT SMOKE when charging or handling batteries.**

KEEP BATTERIES AND ELECTROLYTIC FLUID OUT OF REACH OF CHILDREN.

Batteries vary among manufacturers. Therefore the following procedures may not always apply. Consult your battery manufacturer's instructions.

Procedure

1. Disconnect and remove the battery from the boat. Always disconnect the black negative cable first to prevent the risk of shorting.
2. Clean the battery casing and terminals. Fill each cell to the upper level with distilled water.
3. Store the battery on a level surface in a cool, dry, well-ventilated place out of direct sunlight.
4. Once a month, check the specific gravity of the electrolyte and recharge as required to prolong battery life.

EMU28450

Cleaning the outboard motor

After use, wash the exterior of the outboard motor with fresh water. Flush the cooling system with fresh water.

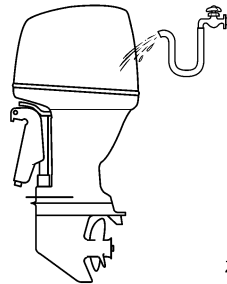

ZMU05174

NOTE: _____

For cooling system flushing instructions, see

Maintenance

page 40.

EMU28460

Checking painted surface of motor

Check the motor for scratches, nicks, or flaking paint. Areas with damaged paint are more likely to corrode. If necessary, clean and paint the areas. A touch-up paint is available from your Yamaha dealer.

EMU28476

Periodic maintenance

EWM01070



Be sure to turn off the engine when you perform maintenance unless otherwise specified. If you or the owner is not familiar with machine servicing, this work should be done by your Yamaha dealer or other qualified mechanic.

EMU28510

Replacement parts

If replacement parts are necessary, use only genuine Yamaha parts or parts of the same type and of equivalent strength and materials. Any part of inferior quality may malfunction, and the resulting loss of control could endanger the operator and passengers. Yamaha genuine parts and accessories are available from your Yamaha dealer.

EMU28522

Maintenance chart

Frequency of maintenance operations may be adjusted according to the operating conditions, but the following table gives general guidelines. Refer to the sections in this chapter for explanations of each owner-specific action.

NOTE:

When operating in salt water, turbid or muddy water, the engine should be flushed with clean water after each use.

The “●” symbol indicates the check-ups which you may carry out yourself.

The “○” symbol indicates work to be carried out by your Yamaha dealer.

Item	Actions	Initial		Every	
		10 hours (1 month)	50 hours (3 months)	100 hours (6 months)	200 hours (1 year)
Anode(s) (external)	Inspection / replacement		●/○	●/○	
Anode(s) (internal)	Inspection / replacement				○
Battery	Inspection / charging	●/○			
Cooling water passages	Cleaning		●	●	
Cowling clamp	Inspection				●
Fuel filter (can be disassembled)	Inspection / cleaning	●	●	●	
Fuel system	Inspection	●	●	●	
Fuel tank (Yamaha portable tank)	Inspection / cleaning				●
Gear oil	Change	●		●	
Greasing points	Greasing			●	
Idling speed (carburetor models)	Inspection	●/○		●/○	
Power trim and tilt unit	Inspection				○
Propeller and cotter pin	Inspection / replacement		●	●	
Shift link / shift cable	Inspection / adjustment				○
Thermostat	Inspection / replacement				○
Throttle link / throttle cable / throttle pick-up timing	Inspection / adjustment				○

Maintenance

Item	Actions	Initial		Every	
		10 hours (1 month)	50 hours (3 months)	100 hours (6 months)	200 hours (1 year)
Water pump	Inspection / replacement				○
Oil pump	Inspection / adjustment	○			
Oil tank water drain	Inspection / cleaning	●/○	●/○	●/○	
Spark plug(s)	Cleaning / adjustment / replacement	●	●	●	

EMU28940

Greasing

Yamaha grease A (water resistant grease)

Yamaha grease D (corrosion resistant grease; for propeller shaft)

30DMHO

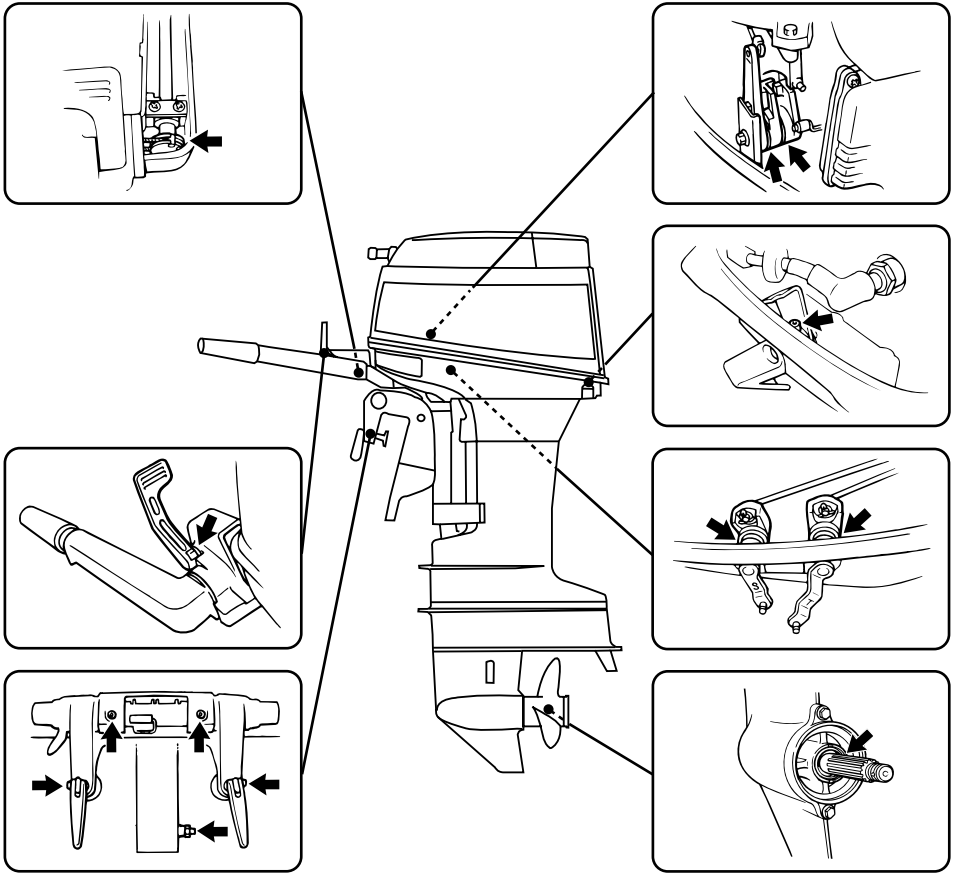

ZMU03793

Maintenance

30DEO, 30DETO

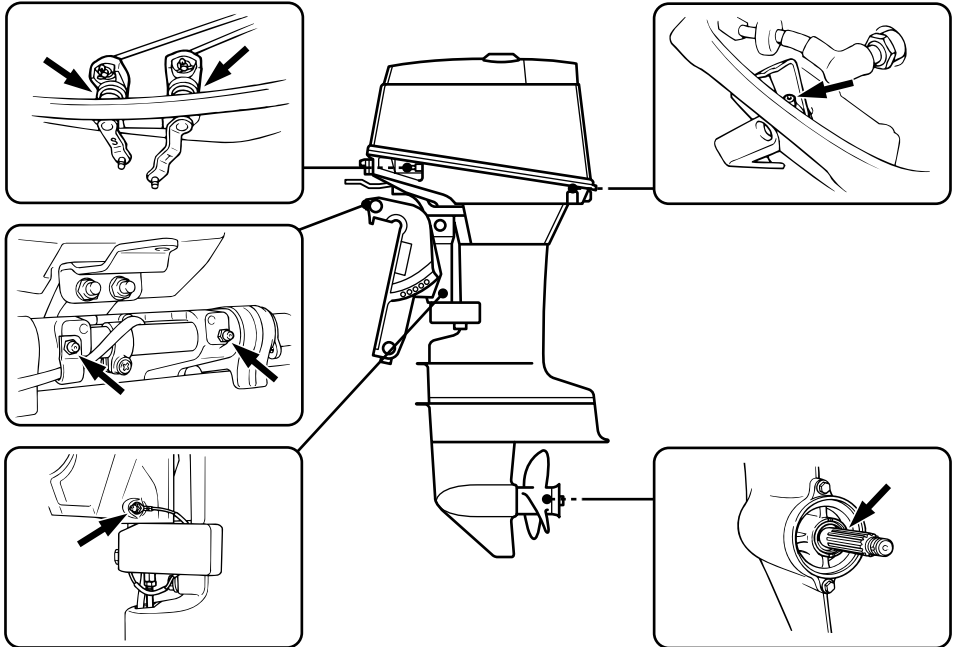

ZMU04860

EMU28952

Cleaning and adjusting spark plug

EWM00560



WARNING

When removing or installing a spark plug, be careful not to damage the insulator. A damaged insulator could allow external sparks, which could lead to explosion or fire.

The spark plug is an important engine component and is easy to inspect. The condition of the spark plug can indicate something about the condition of the engine. For example, if the center electrode porcelain is very white, this could indicate an intake air leak or carburetion problem in that cylinder. Do not attempt to diagnose any problems yourself. Instead, take the outboard motor to a

Yamaha dealer. You should periodically remove and inspect the spark plug because heat and deposits will cause the spark plug to slowly break down and erode. If electrode erosion becomes excessive, or if carbon and other deposits are excessive, you should replace the spark plug with another of the correct type.

Standard spark plug:
BR7HS-10

Before fitting the spark plug, measure the electrode gap with a wire thickness gauge; adjust the gap to specification if necessary.

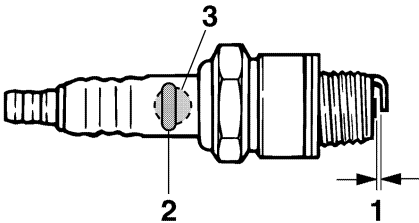

ZMU02179

1. Spark plug gap
2. Spark plug I.D. mark (NGK)
3. Spark plug part number

Spark plug gap:
0.9–1.0 mm (0.035–0.039 in)

When fitting the plug, always clean the gasket surface and use a new gasket. Wipe off any dirt from the threads and screw in the spark plug to the correct torque.

Spark plug torque:
25.0 Nm (18.4 ft-lb) (2.55 kgf-m)

NOTE:

If a torque-wrench is not available when you

are fitting a spark plug, a good estimate of the correct torque is 1/4 to 1/2 a turn past finger-tight. Have the spark plug adjusted to the correct torque as soon as possible with a torque-wrench.

EMU28962

Checking fuel system

EWM00060



Gasoline and its vapors are highly flammable and explosive. Keep away from sparks, cigarettes, flames, or other sources of ignition.

EWM00910



Leaking fuel can result in fire or explosion.

- Check for fuel leakage regularly.
- If any fuel leakage is found, the fuel system must be repaired by a qualified mechanic. Improper repairs can make the outboard unsafe to operate.

Check the fuel lines for leaks, crack, or malfunction. If a problem is found, your Yamaha dealer or other qualified mechanic should repair it immediately.

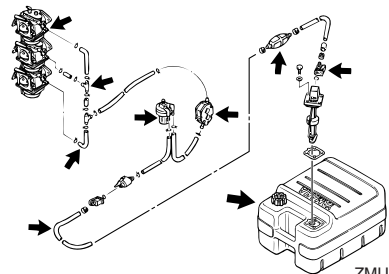

ZMU03795

Checkpoints

- Fuel system parts leakage
- Fuel line joint leakage
- Fuel line cracks or other damage

Maintenance

- Fuel connector leakage

EMU28980

Inspecting fuel filter

EWM00310



Gasoline is highly flammable, and its vapors are flammable and explosive.

- If you have any question about properly doing this procedure, consult your Yamaha dealer.
- Do not perform this procedure on a hot or running engine. Allow the engine to cool.
- There will be fuel in the fuel filter. Keep away from sparks, cigarettes, flames or other sources of ignition.
- This procedure will allow some fuel to spill. Catch fuel in a rag. Wipe up any spilled fuel immediately.
- The fuel filter must be reassembled carefully with the O-ring, filter cup, and hoses in place. Improper assembly or replacement could result in a fuel leak, which could result in a fire or explosion hazard.

EMU29001

Cleaning fuel filter

1. Remove the nut holding the fuel filter assembly if equipped.

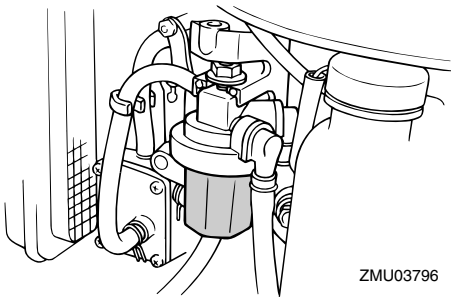

ZMU03796

2. Unscrew the filter cup, catching any spilled fuel in a rag.

3. Remove the filter element, and wash it in solvent. Allow it to dry. Inspect the filter element and O-ring to make sure they are in good condition. Replace them if necessary. If any water is found in the fuel, the Yamaha portable fuel tank or other fuel tanks should be checked and cleaned.

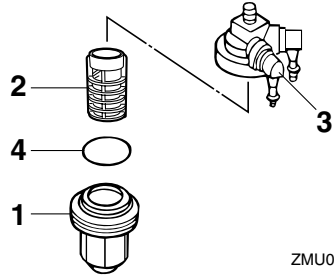

ZMU02079

1. Filter cup
2. Filter element
3. Filter housing
4. O-ring

4. Reinstall the filter element in the cup. Make sure the O-ring is in position in the cup. Firmly screw the cup onto the filter housing.
5. Attach the filter assembly to the bracket so that the fuel hoses are attached to the filter assembly.
6. Run the engine and check the filter and lines for leaks.

EMU29041

Inspecting idling speed

EWM00451



- Do not touch or remove electrical parts when starting or during operation.
- Keep hands, hair, and clothes away from the flywheel and other rotating

parts while the engine is running.

ECM00490

CAUTION:

This procedure must be performed while the outboard motor is in the water. A flushing attachment or test tank can be used.

A diagnostic tachometer should be used for this procedure. Results may vary depending on whether testing is conducted with the flushing attachment, in a test tank, or with the outboard motor in the water.

1. Start the engine and allow it to warm up fully in neutral until it is running smoothly.

NOTE:

Correct idling speed inspection is only possible if the engine is fully warmed up. If not warmed up fully, the idle speed will measure higher than normal. If you have difficulty verifying the idle speed, or the idle speed requires adjustment, consult a Yamaha dealer or other qualified mechanic.

2. Verify whether the idle speed is set to specification. For idle speed specifications, see page 39.

EMU29061

Checking water in engine oil tank

A translucent water drain hose is connected from the bottom of the oil tank to the filler neck. If water or foreign matter collects in this hose, consult a Yamaha dealer.

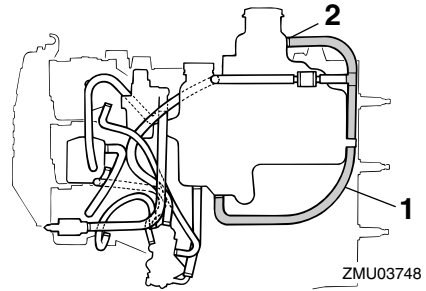

1. Drain hose
2. Filler neck side

EMU29112

Checking wiring and connectors

- Check that each grounding wire is properly secured.
- Check that each connector is engaged securely.

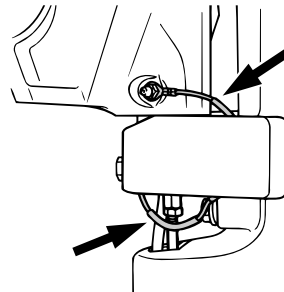

EMU29120

Exhaust leakage

Start the engine and check that no exhaust leaks from the joints between the exhaust cover, cylinder head, and body cylinder.

EMU29130

Water leakage

Start the engine and check that no water leaks from the joints between the exhaust cover, cylinder head, and body cylinder.

Maintenance

EMU29163

Checking power trim and tilt / power tilt system

EWM00430

WARNING

- Never get under the lower unit while it is tilted, even when the tilt support lever is locked. Severe injury could occur if the outboard motor accidentally falls.
- Make sure no one is under the outboard motor before performing this test.

1. Check the power trim and tilt unit / power tilt unit for any sign of oil leaks.

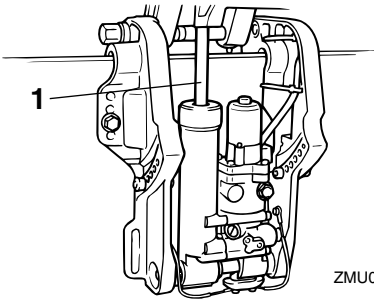

ZMU03798

1. Tilt rod
2. Operate each of the power trim and tilt switches / power tilt switches to check that all switches work.
3. Tilt the outboard motor up and check that the trim and tilt rod / the tilt rod is pushed out completely.
4. Check that the trim and tilt rod / the tilt rod is free of corrosion or other flaws.
5. Tilt the outboard motor down. Check that the trim and tilt rod / the tilt rod operates smoothly.

NOTE:

Consult your Yamaha dealer if any operation is abnormal.

EMU29171

Checking propeller

EWM00321

WARNING

You could be seriously injured if the engine accidentally starts when you are near the propeller.

- Before inspecting, removing, or installing the propeller, remove the spark plug caps from the spark plugs. Also, place the shift control in "OFF" (off) and turn the main switch to "OFF" (off) and remove the key, and remove the lanyard from the engine stop switch. Turn off the battery cut-off switch if your boat has one.
- Do not use your hand to hold the propeller when loosening or tightening the propeller nut. Put a wood block between the anti-cavitation plate and the propeller to prevent the propeller from turning.

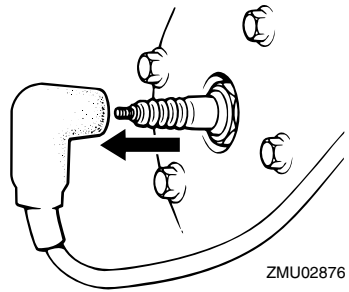

ZMU02876

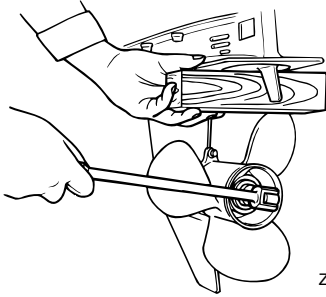

Checkpoints

- Check each of the propeller blades for wear, erosion from cavitation or ventilation, or other damage.
- Check the propeller shaft for damage.
- Check the splines / shear pin for wear or damage.
- Check for fish line tangled around the propeller shaft.

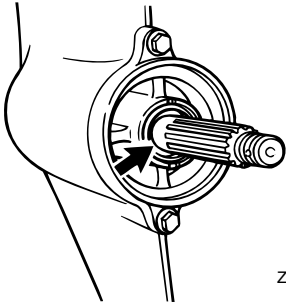

- Check the propeller shaft oil seal for damage.

NOTE:

If the shear pin equipped: it is designed to break if the propeller hits a hard underwater obstacle to help protect the propeller and drive mechanism. The propeller will then spin freely on the shaft. If this happens, the shear pin must be replaced.

EMU30660

Removing the propeller

EMU29194

Spline models

1. Straighten the cotter pin and pull it out using a pair of pliers.
2. Remove the propeller nut, washer, and spacer (if equipped).

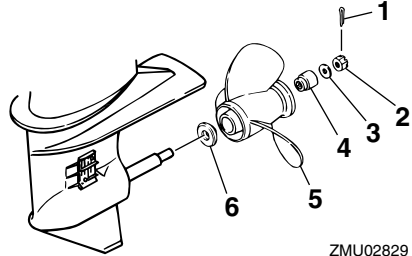

1. Cotter pin
2. Propeller nut
3. Washer
4. Spacer
5. Propeller
6. Thrust washer

3. Remove the propeller and thrust washer.

EMU30670

Installing the Propeller

EMU29231

Spline models

ECM00340

CAUTION:

- Be sure to install the thrust washer before installing the propeller, otherwise the lower case and propeller boss could be damaged.
- Be sure to use a new cotter pin and bend the ends over securely. Otherwise the propeller could come off during operation and be lost.

1. Apply Yamaha marine grease or a cor-

Maintenance

rosion resistant grease to the propeller shaft.

2. Install the spacer (if equipped), thrust washer, and propeller on the propeller shaft.
3. Install the spacer (if equipped) and the washer. Tighten the propeller nut to the specified torque.
4. Align the propeller nut with the propeller shaft hole. Insert a new cotter pin in the hole and bend the cotter pin ends.

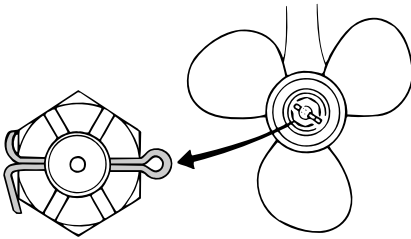

ZMU02063

NOTE:

If the propeller nut does not align with the propeller shaft hole after tightening to the specified torque, tighten the nut further to align it with the hole.

EMU29282

Changing gear oil

EWM00800

WARNING

- Be sure the outboard motor is securely fastened to the transom or a stable stand. You could be severely injured if the outboard motor falls on you.
- Never get under the lower unit while it is tilted, even when the tilt support lever or knob is locked. Severe injury could occur if the outboard motor accidentally falls.

1. Tilt the outboard motor so that the gear

oil drain screw is at the lowest point possible.

2. Place a suitable container under the gear case.
3. Remove the gear oil drain screw and gasket.

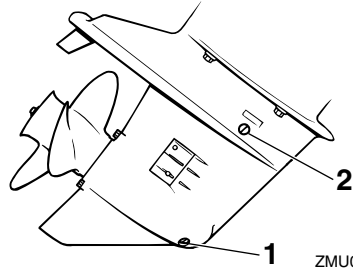

ZMU03738

1. Gear oil drain screw
2. Oil level plug

NOTE:

- If a magnetic gear oil drain screw is equipped, remove all metal particles from the screw before installing it.
- Always use new gaskets. Do not reuse the removed gaskets.

4. Remove the oil level plug and gasket to allow the oil to drain completely.

ECM00710

CAUTION:

Inspect the used oil after it has been drained. If the oil is milky, water is getting into the gear case which can cause gear damage. Consult a Yamaha dealer for repair of the lower unit seals.

NOTE:

For disposal of used oil, consult your Yamaha dealer.

5. With the outboard motor in a vertical position, and using a flexible or pressur-

ized filling device, inject the gear oil into the gear oil drain screw hole.

Recommended gear oil:

Hypoid gear oil SAE#90

Gear oil quantity:

200.0 cm³ (6.76 US oz) (7.05 Imp.oz)

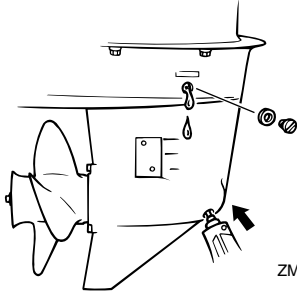

- Put a new gasket on the oil level plug. When the oil begins to flow out of the oil level plug hole, insert and tighten the oil level plug.
- Put a new gasket on the gear oil drain screw. Insert and tighten the gear oil drain screw.

EMU29302

Cleaning fuel tank

EWM00920

WARNING

Gasoline is highly flammable, and its vapors are flammable and explosive.

- If you have any question about properly doing this procedure, consult your Yamaha dealer.
- Keep away from sparks, cigarettes, flames, or other sources of ignition when cleaning the fuel tank.
- Remove the fuel tank from the boat before cleaning it. Work only outdoors in an area with good ventilation.
- Wipe up any spilled fuel immediately.
- Reassemble the fuel tank carefully. Im-

proper assembly can result in a fuel leak, which could result in a fire or explosion hazard.

- Dispose of old gasoline according to local regulations.

- Empty the fuel tank into an approved container.
- Pour a small amount of suitable solvent into the tank. Install the cap and shake the tank. Drain the solvent completely.

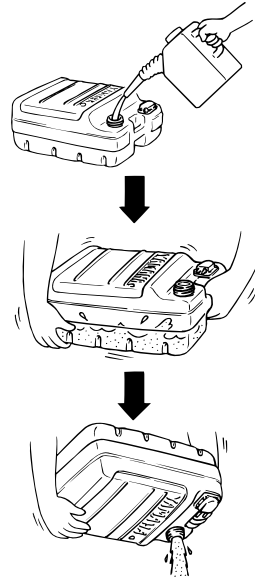

- Remove the screws holding the fuel joint assembly. Pull the assembly out of the tank.

Maintenance

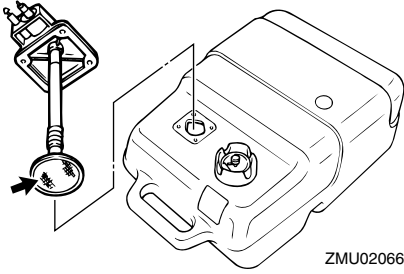

4. Clean the filter (located on the end of the suction pipe) in a suitable cleaning solvent. Allow the filter to dry.
5. Replace the gasket with a new one. Re-install the fuel joint assembly and tighten the screws firmly.

EMU29312

Inspecting and replacing anode(s)

Yamaha outboard motors are protected from corrosion by sacrificial anodes. Inspect the external anodes periodically. Remove scales from the surfaces of the anodes. Consult a Yamaha dealer for replacement of external anodes.

ECM00720

CAUTION:

Do not paint anodes, as this would render them ineffective.

NOTE:

Inspect ground leads attached to external anodes on equipped models. Consult a Yamaha dealer for inspection and replacement of internal anodes attached to the power unit.

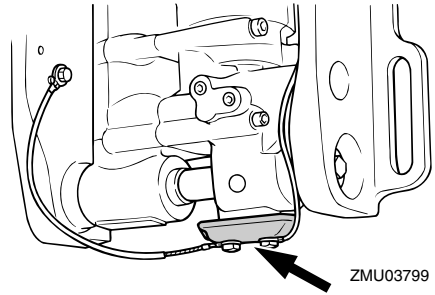
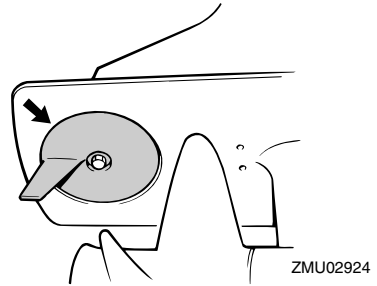

EMU29320

Checking battery (for electric start models)

EWM00330

WARNING

Battery electrolytic fluid is dangerous; it contains sulfuric acid and therefore is poisonous and highly caustic.

Always follow these preventive measures:

- Avoid bodily contact with electrolytic fluid as it can cause severe burns or permanent eye injury.
- Wear protective eye gear when handling or working near batteries.

Antidote (EXTERNAL):

- SKIN - Flush with water.
- EYES - Flush with water for 15 minutes and get immediate medical attention.

Antidote (INTERNAL):

- Drink large quantities of water or milk

followed by milk of magnesia, beaten egg, or vegetable oil. Get immediate medical attention.

Batteries also generate explosive hydrogen gas; therefore, you should always follow these preventive measures:

- Charge batteries in a well-ventilated area.
- Keep batteries away from fire, sparks, or open flames (for example: welding equipment, lighted cigarettes, and so on.)
- DO NOT SMOKE when charging or handling batteries.

KEEP BATTERIES AND ELECTROLYTIC FLUID OUT OF REACH OF CHILDREN.

ECM00360

CAUTION:

- A poorly maintained battery will quickly deteriorate.
- Ordinary tap water contains minerals harmful to a battery, and should not be used for topping up.

1. Check the electrolyte level at least once a month. Fill to the manufacturer's recommended level when necessary. Top up only with distilled water (or pure de-ionized water suitable to use in batteries).

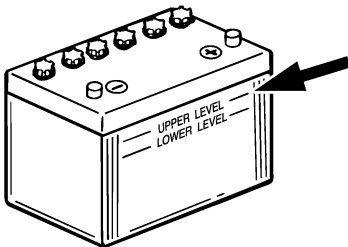

ZMU01810

2. Always keep the battery in a good state

of charge. Installing a voltmeter will help you monitor your battery. If you will not use the boat for a month or more, remove the battery from the boat and store it in a cool, dark place. Completely recharge the battery before using it.

3. If the battery will be stored for longer than a month, check the specific gravity of the fluid at least once a month and recharge the battery when it is low.

NOTE:

Consult a Yamaha dealer when charging or re-charging batteries.

EMU29331

Connecting the battery

EWM00570

WARNING

Mount the battery holder securely in a dry, well-ventilated, vibration-free location in the boat. Install a fully charged battery in the holder.

ECM01121

CAUTION:

- Make sure the main switch (on applicable models) is "OFF" (off) before working on the battery.
- Reversal of the battery cables will damage the electrical parts.
- Connect the red battery cable first when installing the battery and disconnect the black battery cable first when removing it. Otherwise, the electrical parts can be damaged.
- The electrical contacts of the battery and cables must be clean and properly connected, or the battery will not start the engine.

Connect the red battery cable to the POSITIVE (+) terminal first. Then connect the black battery cable to the NEGATIVE (-) ter-

Maintenance

minal.

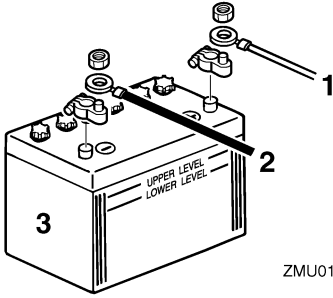

ZMU01811

1. Red cable
2. Black cable
3. Battery

EMU29370

Disconnecting the battery

Disconnect the BLACK cable from the NEGATIVE (-) terminal first. Then disconnect the RED cable from the POSITIVE (+) terminal.

EMU29390

Checking top cowling

Check the fitting of the top cowling by pushing it with both hands. If it is loose have it repaired by your Yamaha dealer.

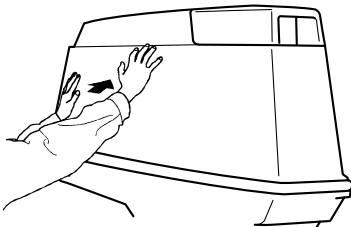

ZMU04678

EMU29400

Coating the boat bottom

A clean hull improves boat performance. The boat bottom should be kept as clean of marine growth as possible. If necessary, the boat bottom can be coated with an anti-foul-

ing paint approved for your area to inhibit marine growth.

Do not use anti-fouling paint which includes copper or graphite. These paints can cause more rapid engine corrosion.

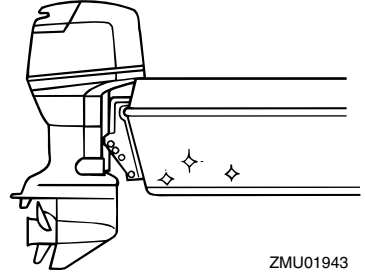

ZMU01943

EMU29424

Troubleshooting

A problem in the fuel, compression, or ignition systems can cause poor starting, loss of power, or other problems. This section describes basic checks and possible remedies, and covers all Yamaha outboard motors. Therefore some items may not apply to your model.

If your outboard motor requires repair, bring it to your Yamaha dealer.

If the engine trouble warning indicator is flashing, consult your Yamaha dealer.

Starter will not operate.

Q. Is battery capacity weak or low?

A. Check battery condition. Use battery of recommended capacity.

Q. Are battery connections loose or corroded?

A. Tighten battery cables and clean battery terminals.

Q. Is fuse for electric start relay or electric circuit blown?

A. Check for cause of electric overload and repair. Replace fuse with one of correct amperage.

Q. Are starter components faulty?

A. Have serviced by a Yamaha dealer.

Q. Is shift lever in gear?

A. Shift to neutral.

Engine will not start (starter operates).

Q. Is fuel tank empty?

A. Fill tank with clean, fresh fuel.

Q. Is fuel contaminated or stale?

A. Fill tank with clean, fresh fuel.

Q. Is fuel filter clogged?

A. Clean or replace filter.

Q. Is starting procedure incorrect?

A. See page 24.

Q. Has fuel pump malfunctioned?

A. Have serviced by a Yamaha dealer.

Q. Are spark plug(s) fouled or of incorrect type?

A. Inspect spark plug(s). Clean or replace with recommended type.

Q. Are spark plug cap(s) fitted incorrectly?

A. Check and re-fit cap(s).

Q. Is ignition wiring damaged or poorly connected?

A. Check wires for wear or breaks. Tighten all loose connections. Replace worn or broken wires.

Q. Are ignition parts faulty?

A. Have serviced by a Yamaha dealer.

Q. Is engine stop switch lanyard not attached?

A. Attach lanyard.

Q. Are engine inner parts damaged?

A. Have serviced by a Yamaha dealer.

Engine idles irregularly or stalls.

Q. Are spark plug(s) fouled or of incorrect type?

A. Inspect spark plug(s). Clean or replace with recommended type.

Trouble Recovery

Q. Is fuel system obstructed?

A. Check for pinched or kinked fuel line or other obstructions in fuel system.

Q. Is fuel contaminated or stale?

A. Fill tank with clean, fresh fuel.

Q. Is fuel filter clogged?

A. Clean or replace filter.

Q. Have ignition parts failed?

A. Have serviced by a Yamaha dealer.

Q. Has warning system activated?

A. Find and correct cause of warning.

Q. Is spark plug gap incorrect?

A. Inspect and adjust as specified.

Q. Is ignition wiring damaged or poorly connected?

A. Check wires for wear or breaks. Tighten all loose connections. Replace worn or broken wires.

Q. Is specified engine oil not being used?

A. Check and replace oil as specified.

Q. Is thermostat faulty or clogged?

A. Have serviced by a Yamaha dealer.

Q. Are carburetor adjustments incorrect?

A. Have serviced by a Yamaha dealer.

Q. Is fuel pump damaged?

A. Have serviced by a Yamaha dealer.

Q. Is air vent screw on fuel tank closed?

A. Open air vent screw.

Q. Is choke knob pulled out?

A. Return to home position.

Q. Is motor angle too high?

A. Return to normal operating position.

Q. Is carburetor clogged?

A. Have serviced by a Yamaha dealer.

Q. Is fuel joint connection incorrect?

A. Connect correctly.

Q. Is throttle valve adjustment incorrect?

A. Have serviced by a Yamaha dealer.

Q. Is battery cable disconnected?

A. Connect securely.

Warning buzzer sounds or indicator lights.

Q. Is cooling system clogged?

A. Check water intake for restriction.

Q. Is engine oil level low?

A. Fill oil tank with specified engine oil.

Q. Is heat range of spark plug incorrect?

A. Inspect spark plug and replace it with recommended type.

Q. Is specified engine oil not being used?

A. Check and replace oil with specified type.

Q. Is engine oil contaminated or deteriorated?

A. Replace oil with fresh, specified type.

Q. Is oil filter clogged?

A. Have serviced by a Yamaha dealer.

Q. Has oil feed/injection pump malfunctioned?

Trouble Recovery

A. Have serviced by a Yamaha dealer.

Q. Is load on boat improperly distributed?

A. Distribute load to place boat on an even plane.

Q. Is water pump or thermostat faulty?

A. Have serviced by a Yamaha dealer.

Q. Is there excess water in fuel filter cup?

A. Drain filter cup.

Engine power loss.

Q. Is propeller damaged?

A. Have propeller repaired or replaced.

Q. Is propeller pitch or diameter incorrect?

A. Install correct propeller to operate outboard at its recommended speed (r/min) range.

Q. Is trim angle incorrect?

A. Adjust trim angle to achieve most efficient operation.

Q. Is motor mounted at incorrect height on transom?

A. Have motor adjusted to proper transom height.

Q. Has warning system activated?

A. Find and correct cause of warning.

Q. Is boat bottom fouled with marine growth?

A. Clean boat bottom.

Q. Are spark plug(s) fouled or of incorrect type?

A. Inspect spark plug(s). Clean or replace with recommended type.

Q. Are weeds or other foreign matter tangled on gear housing?

A. Remove foreign matter and clean lower unit.

Q. Is fuel system obstructed?

A. Check for pinched or kinked fuel line or other obstructions in fuel system.

Q. Is fuel filter clogged?

A. Clean or replace filter.

Q. Is fuel contaminated or stale?

A. Fill tank with clean, fresh fuel.

Q. Is spark plug gap incorrect?

A. Inspect and adjust as specified.

Q. Is ignition wiring damaged or poorly connected?

A. Check wires for wear or breaks. Tighten all loose connections. Replace worn or broken wires.

Q. Have electrical parts failed?

A. Have serviced by a Yamaha dealer.

Q. Is specified fuel not being used?

A. Replace fuel with specified type.

Q. Is specified engine oil not being used?

A. Check and replace oil with specified type.

Q. Is thermostat faulty or clogged?

A. Have serviced by a Yamaha dealer.

Q. Is air vent screw closed?

A. Open the air vent screw.

Q. Is fuel pump damaged?

A. Have serviced by a Yamaha dealer.

Trouble Recovery

Q. Is fuel joint connection incorrect?

A. Connect correctly.

Q. Is heat range of spark plug incorrect?

A. Inspect spark plug and replace it with recommended type.

Q. Is high pressure fuel pump drive belt broken?

A. Have serviced by a Yamaha dealer.

Q. Is engine not responding properly to shift lever position?

A. Have serviced by a Yamaha dealer.

Engine vibrates excessively.

Q. Is propeller damaged?

A. Have propeller repaired or replaced.

Q. Is propeller shaft damaged?

A. Have serviced by a Yamaha dealer.

Q. Are weeds or other foreign matter tangled on propeller?

A. Remove and clean propeller.

Q. Is motor mounting bolt loose?

A. Tighten bolt.

Q. Is steering pivot loose or damaged?

A. Tighten or have serviced by a Yamaha dealer.

EMU29432

Temporary action in emergency

EMU29440

Impact damage

EWM00870



WARNING

The outboard motor can be seriously

damaged by a collision while operating or trailering. Damage could make the outboard motor unsafe to operate.

If the outboard motor hits an object in the water, follow the procedure below.



1. Stop the engine immediately.
2. Inspect the control system and all components for damage. Also inspect the boat for damage.
3. Whether damage is found or not, return to the nearest harbor slowly and carefully.
4. Have a Yamaha dealer inspect the outboard motor before operating it again.

EMU29462

Replacing fuse

If the fuse has blown on an electric start model, open the fuse holder and replace the fuse with a new one of the proper amperage.

EWM00630



Be sure to use the specified fuse. An incorrect fuse or a piece of wire could allow excessive current flow. This could cause electric system damage and a fire hazard.

Trouble Recovery

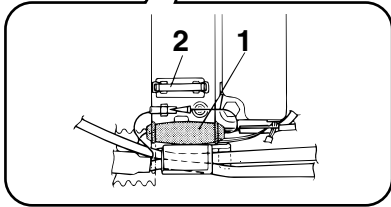
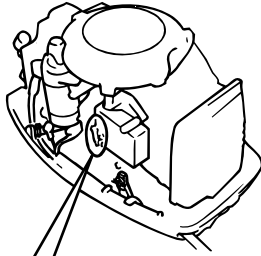

ZMU04849

1. Fuse holder
2. Fuse (10 A)

NOTE:

Consult your Yamaha dealer if the new fuse immediately blows again.

EMU29511

Power trim and tilt / power tilt will not operate

If the engine cannot be tilted up or down with the power trim and tilt / the power tilt because of a discharged battery or a failure with the power trim and tilt unit / the power tilt unit, the engine can be tilted manually.

1. Loosen the manual valve screw by turning it clockwise until it stops.

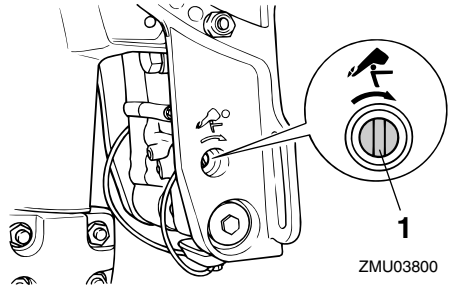

ZMU03800

1. Manual valve screw

2. Put the engine in the desired position, then tighten the manual valve screw by turning it counterclockwise.

EMU29532

Starter will not operate

If the starter mechanism does not operate (the engine cannot be cranked with the starter), the engine can be started with an emergency starter rope.

EWWM01021

WARNING

- Use this procedure only in an emergency to return to the nearest port for repairs.
- When the emergency starter rope is used to start the engine, the start-in-gear protection device does not operate. Make sure the remote control lever is in neutral. Otherwise the boat could unexpectedly start to move, which could result in an accident.
- Attach the engine stop switch lanyard to a secure place on your clothing, or your arm or leg while operating the boat.
- Do not attach the lanyard to clothing that could tear loose. Do not route the cord where it could become entangled,

Trouble Recovery

preventing it from functioning.

- **Avoid accidentally pulling the lanyard during normal operation. Loss of engine power means the loss of most steering control. Also, without engine power, the boat could slow rapidly. This could cause people and objects in the boat to be thrown forward.**
- **Make sure no one is standing behind you when pulling the starter rope. It could whip behind you and injure someone.**
- **An unguarded, rotating flywheel is very dangerous. Keep loose clothing and other objects away when starting the engine. Use the emergency starter rope only as instructed. Do not touch the flywheel or other moving parts when the engine is running. Do not install the starter mechanism or top cowling after the engine is running.**
- **Do not touch the ignition coil, spark plug wire, spark plug cap, or other electrical components when starting or operating the motor. You could get an electrical shock.**

EMU29561

Emergency starting engine

1. Remove the top cowling.
2. Remove the start-in-gear protection cable from the starter, if equipped.

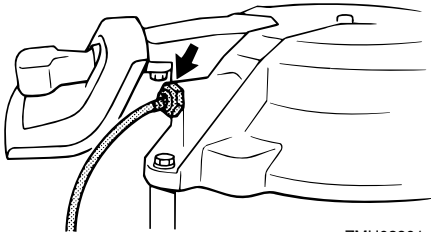

ZMU03801

3. Remove the starter/flywheel cover after removing the bolt(s).

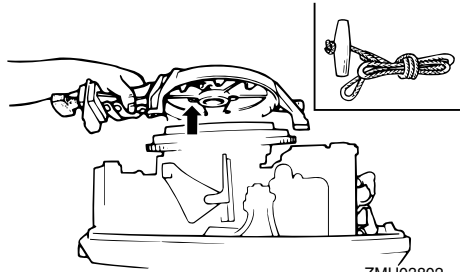

ZMU03802

4. Prepare the engine for starting. For further information, see page 24. Be sure the engine is in neutral and that the engine stop switch lanyard lock plate is attached to the engine stop switch. The main switch must be "ON" (on), if equipped.

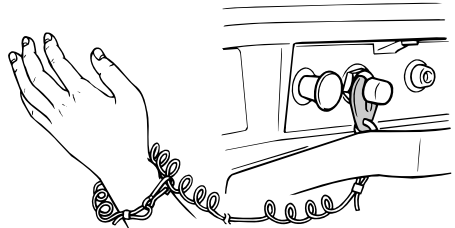

ZMU03803

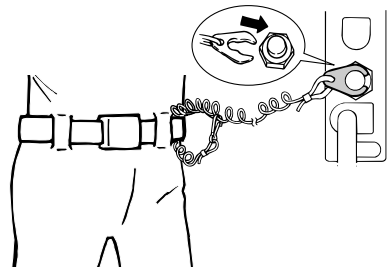

ZMU02334

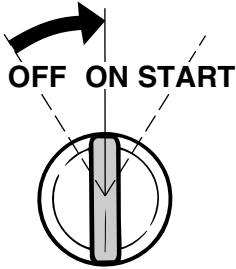

ZMU01906

5. If equipped the choke knob, pull out it when the engine is cold. After the engine starts, gradually return the choke knob to its home position as the engine warms up.

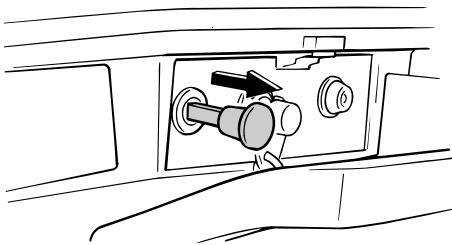

ZMU03804

6. Insert the knotted end of the emergency starter rope into the notch in the flywheel rotor and wind the rope several turns around the flywheel clockwise.
7. Give a strong pull straight out to crank and start the engine. Repeat if necessary.

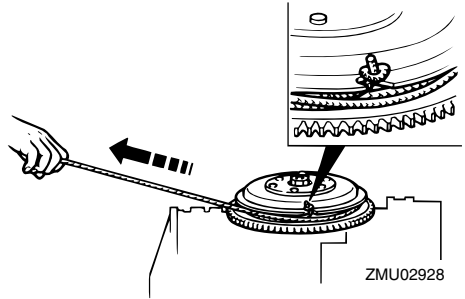

ZMU02928

EMU29760

Treatment of submerged motor

If the outboard motor is submerged, immediately take it to a Yamaha dealer. Otherwise some corrosion may begin almost immediately.

If you cannot immediately take the outboard motor to a Yamaha dealer, follow the procedure below in order to minimize engine damage.

EMU29771

Procedure

1. Thoroughly wash away mud, salt, seaweed, and so on, with fresh water.



ZMU01909

2. Remove the spark plugs and face the spark plug holes downward to allow any water, mud, or contaminants to drain.

Trouble Recovery

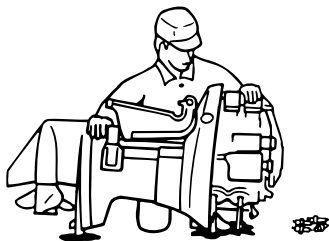

ZMU01910

3. Drain the fuel from the carburetor, fuel filter, and fuel line.
4. Feed fogging oil or engine oil through the carburetor(s) and spark plug holes while cranking with the manual starter or emergency starter rope.

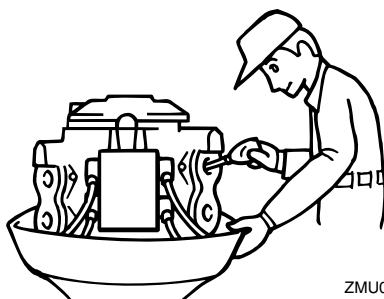

ZMU01911

5. Take the outboard motor to a Yamaha dealer as soon as possible.

ECM00400

CAUTION: _____

Do not attempt to run the outboard motor until it has been completely inspected.



YAMAHA MOTOR CO., LTD.

Printed in Japan

April 2006-0.3 × 1 

Printed on recycled paper