



# YAMAHA



**F80B**  
**F80C**  
**F100D**

## OWNER'S MANUAL

**▲** Read this manual carefully before operating this outboard motor.

6D7-28199-76-E0

**Read this manual carefully before operating this outboard motor. Keep this manual onboard in a waterproof bag when boating. This manual should stay with the outboard motor if it is sold.**

# Important manual information

EMU25105

## To the owner

Thank you for choosing a Yamaha outboard motor. This Owner's Manual contains information needed for proper operation, maintenance and care. A thorough understanding of these simple instructions will help you obtain maximum enjoyment from your new Yamaha. If you have any question about the operation or maintenance of your outboard motor, please consult a Yamaha dealer.

In this Owner's Manual particularly important information is distinguished in the following ways.



: This is the safety alert symbol. It is used to alert you to potential personal injury hazards. Obey all safety messages that follow this symbol to avoid possible injury or death.

EWU00781



### **WARNING**

**A WARNING indicates a hazardous situation which, if not avoided, could result in death or serious injury.**

ECM00701

### **NOTICE**

**A NOTICE indicates special precautions that must be taken to avoid damage to the outboard motor or other property.**

### **TIP:**

A TIP provides key information to make procedures easier or clearer.

Yamaha continually seeks advancements in product design and quality. Therefore, while this manual contains the most current product information available at the time of printing, there may be minor discrepancies between

your machine and this manual. If there is any question concerning this manual, please consult your Yamaha dealer.

To ensure long product life, Yamaha recommends that you use the product and perform the specified periodic inspections and maintenance by correctly following the instructions in the owner's manual. Any damage resulting from neglect of these instructions is not covered by warranty.

Some countries have laws or regulations restricting users from taking the product out of the country where it was purchased, and it may be impossible to register the product in the destination country. Additionally, the warranty may not apply in certain regions. When planning to take the product to another country, consult the dealer where the product was purchased for further information.

If the product was purchased used, please consult your closest dealer for customer re-registration, and to be eligible for the specified services.

### **TIP:**

The F80BET, F80CED, F100DET and the standard accessories are used as a base for the explanations and illustrations in this manual. Therefore some items may not apply to every model.

EMU25121

### **F80B, F80C, F100D OWNER'S MANUAL**

**©2009 by Yamaha Motor Co., Ltd.**

**1st Edition, March 2009**

**All rights reserved.**

**Any reprinting or unauthorized use  
without the written permission of**

**Yamaha Motor Co., Ltd.**

**is expressly prohibited.**

**Printed in Japan**

# Table of contents

---

<b>Safety information</b> .....	1	Propeller selection .....	11
Outboard motor safety .....	1	Start-in-gear protection .....	12
Propeller .....	1	Engine oil requirements .....	12
Rotating parts .....	1	Fuel requirements .....	13
Hot parts .....	1	Gasoline .....	13
Electric shock .....	1	Muddy or acidic water .....	13
Power trim and tilt.....	1	Anti-fouling paint .....	13
Engine shut-off cord (lanyard) .....	1	Motor disposal requirements.....	13
Gasoline .....	1	Emergency equipment .....	13
Gasoline exposure and spills .....	1	<b>Components</b> .....	<b>14</b>
Carbon monoxide .....	2	Components diagram.....	14
Modifications .....	2	Fuel tank.....	16
Boating safety .....	2	Fuel joint.....	16
Alcohol and drugs.....	2	Fuel gauge .....	17
Personal flotation devices .....	2	Fuel tank cap.....	17
People in the water.....	2	Air vent screw .....	17
Passengers .....	2	Remote control transmitter .....	17
Overloading .....	2	Receiver .....	18
Avoid collisions.....	2	Yamaha Security System lock and unlock mode.....	18
Weather.....	3	Remote control box .....	18
Passenger training .....	3	Remote control lever .....	18
Boating safety publications.....	3	Neutral interlock trigger .....	19
Laws and regulations .....	3	Neutral throttle lever .....	19
<b>General information</b> .....	<b>4</b>	Tiller handle .....	19
Identification numbers record .....	4	Gear shift lever .....	19
Outboard motor serial number .....	4	Throttle grip .....	20
Key number .....	4	Throttle indicator.....	20
EC Declaration of Conformity (DoC).....	4	Throttle friction adjuster.....	20
CE Marking .....	5	Engine shut-off cord (lanyard) and clip.....	21
Read manuals and labels.....	6	Engine stop button .....	21
Warning labels.....	6	Main switch.....	22
<b>Specifications and requirements</b> .....	<b>9</b>	Steering friction adjuster.....	22
Specifications .....	9	Power trim and tilt switch on remote control or tiller handle.....	22
Installation requirements .....	10	Power trim and tilt switch on bottom engine cowling .....	23
Boat horsepower rating .....	10	Variable trolling RPM switches .....	23
Mounting motor .....	11	Trim tab with anode .....	24
Yamaha Security System .....	11	Trim angle adjusting bolts .....	24
Remote control requirements .....	11	Tilt lock mechanism.....	25
Battery requirements .....	11	Tilt support lever for power trim and tilt or hydro tilt model.....	25
Battery specifications .....	11		
Mounting battery.....	11		

# Table of contents

Cowling lock lever (pull up type).....	25	<b>Operation</b> .....	<b>42</b>
Flushing device .....	26	First-time operation .....	42
Fuel filter/Water separator.....	26	Fill engine oil .....	42
Alert indicator .....	26	Breaking in engine.....	42
<b>Instruments and indicators</b> .....	<b>27</b>	Getting to know your boat .....	42
Indicators.....	27	Checks before starting engine .....	42
Low oil pressure-alert indicator .....	27	Fuel level .....	42
Overheat-alert indicator.....	27	Remove cowling.....	43
Digital tachometer .....	27	Fuel system .....	43
Tachometer .....	28	Controls .....	43
Trim meter .....	28	Engine shut-off cord (lanyard) .....	44
Hour meter .....	28	Engine oil.....	44
Low oil pressure-alert indicator .....	28	Engine .....	45
Overheat-alert indicator .....	29	Flushing device .....	45
Digital speedometer .....	29	Install cowling .....	45
Speedometer.....	29	Power trim and tilt system .....	46
Fuel gauge .....	29	Battery .....	46
Trip meter / Clock / Voltmeter.....	30	Filling fuel.....	46
Fuel level-alert indicator .....	31	Operating engine .....	47
Low battery voltage-alert indicator ...	31	Sending fuel (portable tank) .....	47
Hour meter .....	31	Starting engine .....	48
6Y8 Multifunction meters.....	31	Checks after starting engine .....	51
6Y8 Multifunction tachometers .....	31	Cooling water .....	51
Start-up checks .....	32	Warming up engine.....	51
Yamaha Security System		Electric start models .....	51
information .....	33	Checks after engine warm-up .....	52
Low oil pressure-alert .....	33	Shifting .....	52
Overheat alert.....	34	Stop switches .....	52
Water separator alert.....	34	Shifting .....	52
Engine trouble alert .....	35	Stopping boat.....	53
Low battery voltage-alert .....	35	Trolling .....	54
6Y8 Multifunction speed & fuel		Adjusting trolling speed .....	54
meters .....	35	Stopping engine.....	54
6Y8 Multifunction speedometers... ..	36	Procedure .....	54
6Y8 Multifunction fuel		Trimming outboard motor.....	55
management meters .....	37	Adjusting trim angle	
<b>Engine control system</b> .....	<b>38</b>	(Power trim and tilt).....	56
Alert system .....	38	Adjusting trim angle for hydro tilt	
Overheat alert.....	38	models .....	56
Low oil pressure alert .....	38	Adjusting boat trim.....	57
<b>Installation</b> .....	<b>40</b>	Tilting up and down.....	58
Installation .....	40	Procedure for tilting up	
Mounting the outboard motor .....	40	(hydro tilt models) .....	58

# Table of contents

---

Procedure for tilting up (power trim and tilt models).....	59	Replacing fuse.....	88
Procedure for tilting down (hydro tilt models) .....	61	Power trim and tilt will not operate ...	88
Procedure for tilting down (power trim and tilt models).....	61	Water separator-alert indicator blinks while cruising .....	88
Shallow water.....	62	Starter will not operate .....	90
Hydro tilt models.....	62	Emergency starting engine.....	91
Power trim and tilt models.....	63	Treatment of submerged motor ....	92
Cruising in other conditions.....	64		
<b>Maintenance.....</b>	<b>65</b>		
Transporting and storing outboard motor .....	65		
Storing outboard motor.....	65		
Procedure.....	66		
Lubrication.....	67		
Flushing power unit .....	67		
Cleaning the outboard motor.....	68		
Checking painted surface of motor...	68		
Periodic maintenance.....	68		
Replacement parts .....	69		
Severe operating conditions.....	69		
Maintenance chart 1 .....	70		
Maintenance chart 2.....	72		
Greasing.....	73		
Cleaning and adjusting spark plug ...	75		
Inspecting idling speed.....	75		
Changing engine oil.....	76		
Checking wiring and connectors .....	77		
Checking propeller .....	78		
Removing propeller .....	79		
Installing propeller .....	79		
Changing gear oil .....	80		
Cleaning fuel tank.....	81		
Inspecting and replacing anode(s) ...	82		
Checking battery (for electric start models) .....	82		
Connecting the battery .....	83		
Disconnecting the battery.....	83		
Storing the battery .....	83		
<b>Trouble Recovery .....</b>	<b>84</b>		
Troubleshooting .....	84		
Temporary action in emergency....	87		
Impact damage.....	87		

EMU33622

## Outboard motor safety

Observe these precautions at all times.

EMU36501

### Propeller

People can be injured or killed if they come in contact with the propeller. The propeller can keep moving even when the motor is in neutral, and sharp edges of the propeller can cut even when stationary.

- Stop the engine when a person is in the water near you.
- Keep people out of reach of the propeller, even when the engine is off.

EMU33630

### Rotating parts

Hands, feet, hair, jewelry, clothing, PFD straps, etc. can become entangled with internal rotating parts of the engine, resulting in serious injury or death.

Keep the top cowling in place whenever possible. Do not remove or replace the cowling with the engine running.

Only operate the engine with the cowling removed according to the specific instructions in the manual. Keep hands, feet, hair, jewelry, clothing, PFD straps, etc. away from any exposed moving parts.

EMU33640

### Hot parts

During and after operation, engine parts are hot enough to cause burns. Avoid touching any parts under the top cowling until the engine has cooled.

EMU33650

### Electric shock

Do not touch any electrical parts while starting or operating the engine. They can cause shock or electrocution.

EMU33660

### Power trim and tilt

Body parts can be crushed between the motor and the clamp bracket when the motor is trimmed or tilted. Keep body parts out of this

area at all times. Be sure no one is in this area before operating the power trim and tilt mechanism.

The power trim and tilt switches operate even when the main switch is off. Keep people away from the switches whenever working around the motor.

Never get under the lower unit while it is tilted, even when the tilt support lever is locked. Severe injury could occur if the outboard motor accidentally falls.

EMU33671

### Engine shut-off cord (lanyard)

Attach the engine shut-off cord so that the engine stops if the operator falls overboard or leaves the helm. This prevents the boat from running away under power and leaving people stranded, or running over people or objects.

Always attach the engine shut-off cord to a secure place on your clothing or your arm or leg while operating. Do not remove it to leave the helm while the boat is moving. Do not attach the cord to clothing that could tear loose, or route the cord where it could become entangled, preventing it from functioning.

Do not route the cord where it is likely to be accidentally pulled out. If the cord is pulled during operation, the engine will shut off and you will lose most steering control. The boat could slow rapidly, throwing people and objects forward.

EMU33810

### Gasoline

**Gasoline and its vapors are highly flammable and explosive.** Always, refuel according to the procedure on page 47 to reduce the risk of fire and explosion.

EMU33820

### Gasoline exposure and spills

Take care not to spill gasoline. If gasoline spills, wipe it up immediately with dry rags. Dispose of rags properly.

# Safety information

---

If any gasoline spills onto your skin, immediately wash with soap and water. Change clothing if gasoline spills on it.

If you swallow gasoline, inhale a lot of gasoline vapor, or get gasoline in your eyes, get immediate medical attention. Never siphon fuel by mouth.

EMU33900

## **Carbon monoxide**

This product emits exhaust gases which contain carbon monoxide, a colorless, odorless gas which may cause brain damage or death when inhaled. Symptoms include nausea, dizziness, and drowsiness. Keep cockpit and cabin areas well ventilated. Avoid blocking exhaust outlets.

EMU33780

## **Modifications**

Do not attempt to modify this outboard motor. Modifications to your outboard motor may reduce safety and reliability, and render the outboard unsafe or illegal to use.

EMU33740

## **Boating safety**

This section includes a few of the many important safety precautions that you should follow when boating.

EMU33710

## **Alcohol and drugs**

Never operate after drinking alcohol or taking drugs. Intoxication is one of the most common factors contributing to boating fatalities.

EMU33720

## **Personal flotation devices**

Have an approved personal flotation device (PFD) on board for every occupant. Yamaha recommends that you must wear a PFD whenever boating. At a minimum, children and non-swimmers should always wear PFDs, and everyone should wear PFDs when there are potentially hazardous boating conditions.

EMU33731

## **People in the water**

Always watch carefully for people in the water, such as swimmers, skiers, or divers, whenever the engine is running. When someone is in the water near the boat, shift into neutral and stop the engine.

Stay away from swimming areas. Swimmers can be hard to see.

The propeller can keep moving even when the motor is in neutral. Stop the engine when a person is in the water near you.

EMU33751

## **Passengers**

Consult your boat manufacturer's instructions for details about appropriate passenger locations in your boat and be sure all passengers are positioned properly before accelerating and when operating above an idle speed. Standing or sitting in non-designated locations may result in being thrown either overboard or within the boat due to waves, wakes, or sudden changes in speed or direction. Even when people are positioned properly, alert your passengers if you must make any unusual maneuver. Always avoid jumping waves or wakes.

EMU33760

## **Overloading**

Do not overload the boat. Consult the boat capacity plate or boat manufacturer for maximum weight and number of passengers. Be sure that weight is properly distributed according to the boat manufacturer's instructions. Overloading or incorrect weight distribution can compromise the boat's handling and lead to an accident, capsizing or swamping.

EMU33772

## **Avoid collisions**

Scan constantly for people, objects, and other boats. Be alert for conditions that limit your visibility or block your vision of others.



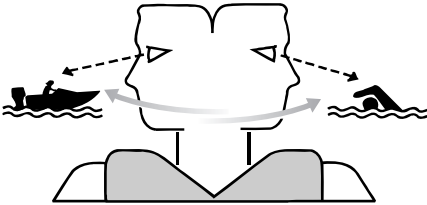

ZMU06025

Operate defensively at safe speeds and keep a safe distance away from people, objects, and other boats.

- Do not follow directly behind other boats or waterskiers.
- Avoid sharp turns or other maneuvers that make it hard for others to avoid you or understand where you are going.
- Avoid areas with submerged objects or shallow water.
- Ride within your limits and avoid aggressive maneuvers to reduce the risk of loss of control, ejection, and collision.
- Take early action to avoid collisions. Remember, boats do not have brakes, and stopping the engine or reducing throttle can reduce the ability to steer. If you are not sure that you can stop in time before hitting an obstacle, apply throttle and turn in another direction.

EMU33790

## **Weather**

Stay informed about the weather. Check weather forecasts before boating. Avoid boating in hazardous weather.

EMU33880

## **Passenger training**

Make sure at least one other passenger is trained to operate the boat in the event of an emergency.

EMU33890

## **Boating safety publications**

Be informed about boating safety. Additional publications and information can be obtained from many boating organizations.

EMU33600

## **Laws and regulations**

Know the marine laws and regulations where you will be boating- and obey them. Several sets of rules prevail according to geographic location, but all are basically the same as the International Rules of the Road.

# General information

EMU25171

## Identification numbers record

EMU25183

### Outboard motor serial number

The outboard motor serial number is stamped on the label attached to the port side of the clamp bracket.

Record your outboard motor serial number in the spaces provided to assist you in ordering spare parts from your Yamaha dealer or for reference in case your outboard motor is stolen.

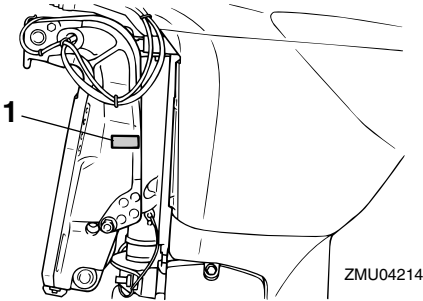

ZMU04214

1. Outboard motor serial number location

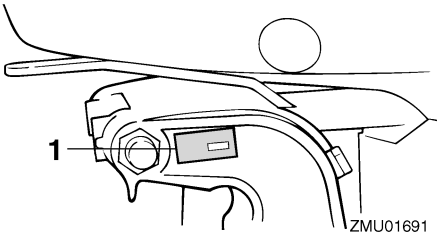

ZMU01691

1. Outboard motor serial number location

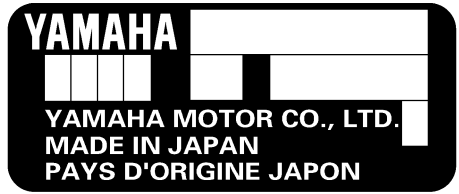

ZMU01692

EMU25190

### Key number

If a main key switch is equipped with the motor, the key identification number is stamped on your key as shown in the illustration. Record this number in the space provided for reference in case you need a new key.



ZMU01693

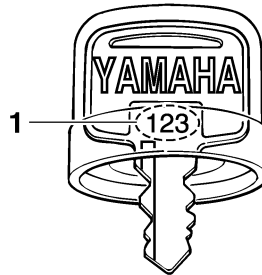

ZMU01694

1. Key number

EMU37290

## EC Declaration of Conformity (DoC)

This outboard motor conforms to certain portions of the European Parliament directive relating to machinery.

Each conformed outboard motor accompanied with EC DoC. EC DoC contains the following information;

- Name of Engine Manufacture
- Model name

- Product code of model (Approved model code)
- Code of conformed directives

EMU25203

## CE Marking

Outboard motors affixed with this “CE” marking conform with the directives of; 98/37/EC, 94/25/EC - 2003/44/EC and 2004/108/EC.

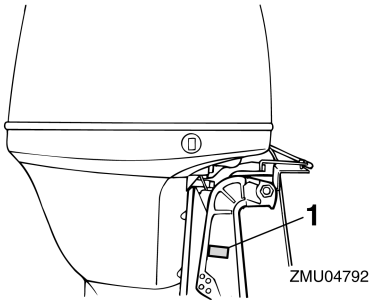

1. CE marking location



ZMU06040

# General information

---

EMU33520

## Read manuals and labels

Before operating or working on this motor:

- Read this manual.
  - Read any manuals supplied with the boat.
  - Read all labels on the outboard motor and the boat.
- If you need any additional information, contact your Yamaha dealer.

EMU33831

## Warning labels

If these labels are damaged or missing, contact your Yamaha dealer for replacements.

**F80BET, F80CED, F100DET**

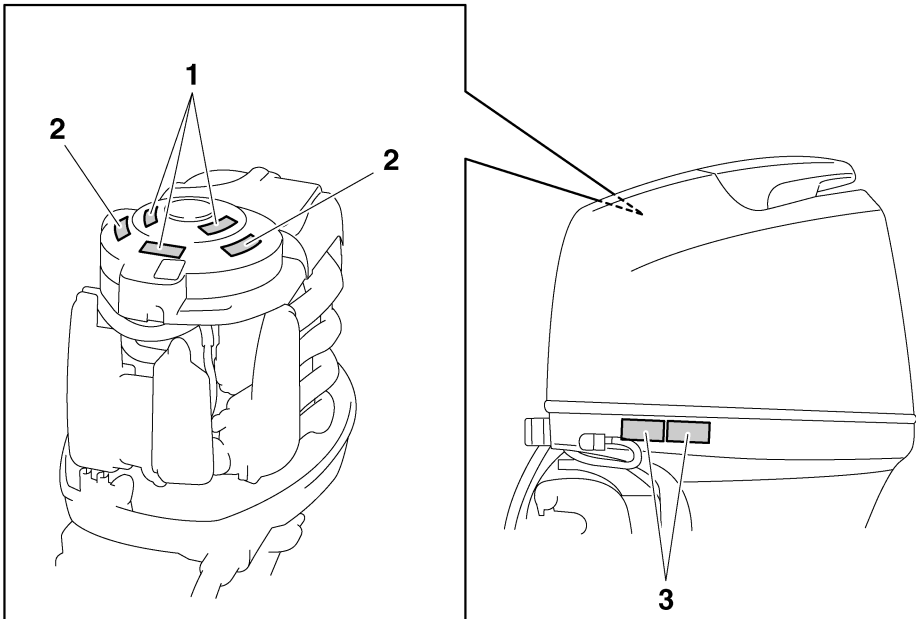

ZMU05683

1

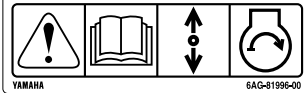

2

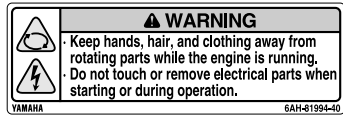

3



ZMU05706

EMU33912

## Contents of labels

The above warning labels mean as follows.

1

EWM01691

### **⚠ WARNING**

Emergency starting does not have start-in-gear protection. Ensure shift control is in neutral before starting engine.

2

EWM01681

### **⚠ WARNING**

- Keep hands, hair, and clothing away from rotating parts while the engine is running.
- Do not touch or remove electrical parts when starting or during operation.

3

EWM01671

### **⚠ WARNING**

- Read Owner's Manuals and labels.
- Wear an approved personal flotation device (PFD).
- Attach engine shut-off cord (lanyard) to your PFD, arm, or leg so the engine stops if you accidentally leave the helm, which could prevent a runaway boat.

# General information

---

EMU33843

## Symbols

The following symbols mean as follows.

Notice/Warning



ZMU05696

Read Owner's Manual

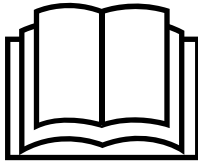

ZMU05664

Hazard caused by continuous rotation

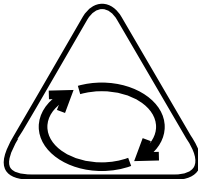

ZMU05665

Electrical hazard

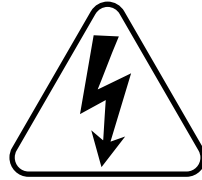

ZMU05666

Remote control lever/gear shift lever operating direction, dual direction



ZMU05667

Engine start/ Engine cranking

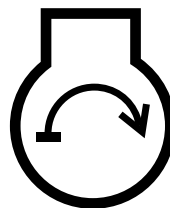

ZMU05668

# Specifications and requirements

EMU34520

## Specifications

### TIP:

“(AL)” stated in the specification data below represents the numerical value for the aluminum propeller installed.

Likewise, “(SUS)” represents the value for stainless steel propeller installed and “(PL)” for plastic propeller installed.

### TIP:

“(\*)” means, select the engine oil referring to the chart of engine oil paragraph. For further information, see page 12.

EMU2821E

### Dimension:

Overall length:

825 mm (32.5 in)

Overall width:

F100DET 479 mm (18.9 in)

F80BET 479 mm (18.9 in)

F80CED 486 mm (19.1 in)

Overall height L:

F100DET 1582 mm (62.3 in)

F80BET 1582 mm (62.3 in)

F80CED 1596 mm (62.8 in)

Transom height L:

F100DET 536 mm (21.1 in)

F80BET 536 mm (21.1 in)

F80CED 516 mm (20.3 in)

Weight (AL) L:

F100DET 170.0 kg (375 lb)

F80BET 170.0 kg (375 lb)

F80CED 177.0 kg (390 lb)

### Performance:

Full throttle operating range:

5000–6000 r/min

Maximum output:

F100DET 73.6 kW @ 5500 r/min (100

HP @ 5500 r/min)

F80BET 58.8 kW @ 5500 r/min (80

HP @ 5500 r/min)

F80CED 58.8 kW @ 5500 r/min (80

HP @ 5500 r/min)

Idling speed (in neutral):

700 ± 50 r/min

### Engine:

Type:

4-stroke L

Displacement:

1596.0 cm<sup>3</sup>

Bore × stroke:

79.0 × 81.4 mm (3.11 × 3.20 in)

Ignition system:

TCI

Spark plug (NGK):

LFR5A-11

Spark plug gap:

1.0–1.1 mm (0.039–0.043 in)

Control system:

Remote control

Starting system:

Electric

Starting carburetion system:

Electronic fuel injection

Valve clearance (cold engine) IN:

0.17–0.23 mm (0.0067–0.0091 in)

Valve clearance (cold engine) EX:

0.31–0.37 mm (0.0122–0.0146 in)

Min. cold cranking amps (CCA/EN):

430.0 A

Min. rated capacity (20HR/IEC):

70.0 Ah

Maximum generator output:

25 A

### Drive unit:

Gear positions:

Forward-neutral-reverse

# Specifications and requirements

---

## Gear ratio:

F100DET 2.31(30/13)

F80BET 2.31(30/13)

F80CED 2.15(28/13)

## Trim and tilt system:

F100DET Power trim and tilt

F80BET Power trim and tilt

F80CED Hydro tilt

## Propeller mark:

F100DET K

F80BET K

F80CED K

## Fuel and oil:

### Recommended fuel:

Regular unleaded gasoline

### Min. research octane:

90

### Fuel tank capacity:

25.0 L (6.61 US gal, 5.50 Imp.gal)

### Recommended engine oil:

4-stroke outboard motor oil

### Recommended engine oil group 1\*:

SAE 10W-30/10W-40/5W-30

API SE/SF/SG/SH/SJ/SL

### Recommended engine oil group 2\*:

SAE 15W-40/20W-40/20W-50

API SH/SJ/SL

### Lubrication:

Wet sump

### Total engine oil quantity (oil pan capacity):

#### Without oil filter replacement:

4.3 L (4.55 US qt, 3.78 Imp.qt)

#### With oil filter replacement:

4.5 L (4.76 US qt, 3.96 Imp.qt)

### Recommended gear oil:

Hypoid gear oil SAE#90

## Gear oil quantity:

F100DET 0.670 L (0.708 US qt,  
0.590 Imp.qt)

F80BET 0.670 L (0.708 US qt,  
0.590 Imp.qt)

F80CED 0.760 L (0.803 US qt,  
0.669 Imp.qt)

## Tightening torque for engine:

### Spark plug:

25.0 Nm (2.55 kgf-m, 18.4 ft-lb)

### Propeller nut:

F100DET 35.0 Nm (3.57 kgf-m,

25.8 ft-lb)

F80BET 35.0 Nm (3.57 kgf-m, 25.8 ft-lb)

F80CED 55.0 Nm (5.61 kgf-m, 40.6 ft-lb)

### Engine oil drain bolt:

28.0 Nm (2.86 kgf-m, 20.7 ft-lb)

### Engine oil filter:

18.0 Nm (1.84 kgf-m, 13.3 ft-lb)

## Noise and vibration level:

Operator sound pressure level (ICOMIA  
39/94 and 40/94):

73.2 dB(A)

EMU33554

## Installation requirements

EMU33563

## Boat horsepower rating

EWM01560



**Overpowering a boat can cause severe instability.**

Before installing the outboard motor(s), confirm that the total horsepower of your motor(s) does not exceed the boat's maximum horsepower rating. See the boat's capacity plate or contact the manufacturer.



# Specifications and requirements

EMU33571

## Mounting motor

EWM01570



- **Improper mounting of the outboard motor could result in hazardous conditions such as poor handling, loss of control, or fire hazards.**
- **Because the motor is very heavy, special equipment and training is required to mount it safely.**

Your dealer or other person experienced in proper rigging should mount the motor using correct equipment and complete rigging instructions. For further information, see page 40.

EMU38580

## Yamaha Security System

This outboard motor is equipped with the Yamaha Security System to protect against theft, which consists of the receiver and remote control transmitter. The engine can not be started if the security system is in the lock mode, and only be started in the unlock mode. Consult your Yamaha dealer for installation of the receiver.

EMU33581

## Remote control requirements

EWM01580



- **If the engine starts in gear, the boat can move suddenly and unexpectedly, possibly causing a collision or throwing passengers overboard.**
- **If the engine ever starts in gear, the start-in-gear protection device is not working correctly and you should discontinue using the outboard. Contact your Yamaha dealer.**

The remote control unit must be equipped with a start-in-gear protection device(s). This device prevents the engine from starting unless it is in neutral.

EMU25694

## Battery requirements

EMU25721

### Battery specifications

Minimum cold cranking amps (CCA/EN): 430.0 A
Minimum rated capacity (20HR/IEC): 70.0 Ah

The engine cannot be started if battery voltage is too low.

EMU36290

## Mounting battery

Mount the battery holder securely in a dry, well-ventilated, vibration-free location in the boat. **WARNING! Do not put flammable items, or loose heavy or metal objects in the same compartment as the battery. Fire, explosion or sparks could result.**

[EWM01820]

EMU34192

## Propeller selection

Next to selecting an outboard, choosing the right propeller is one of the most important purchasing decisions a boater can make. The type, size, and design of your propeller have a direct impact on acceleration, top speed, fuel economy, and even engine life. Yamaha designs and manufactures propellers for every Yamaha outboard motor and every application.

Your outboard motor came with a Yamaha propeller chosen to perform well over a range of applications, but there may be uses where a different propeller would be more appropriate.

Your Yamaha dealer can help you select the right propeller for your boating needs. Select a propeller that will allow the engine to reach

# Specifications and requirements

the middle or upper half of the operating range at full throttle with the maximum boat-load. Generally, chose a larger pitch propeller for a smaller operating load and a smaller pitch propeller for a heavier load. If you carry loads that vary widely, chose the propeller that lets the engine run in the proper range for your maximum load but remember that you may need to reduce your throttle setting to stay within the recommended engine speed range when carrying lighter loads.

For instructions on propeller removal and installation, see page 78.

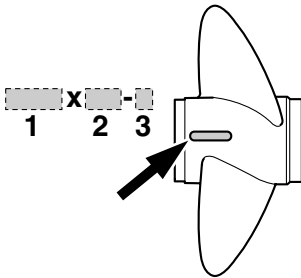

ZMU04606

1. Propeller diameter in inches
2. Propeller pitch in inches
3. Type of propeller (propeller mark)

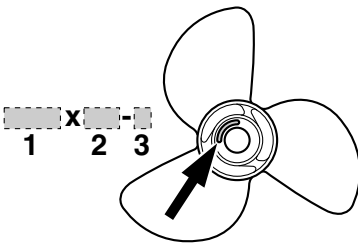

ZMU04607

1. Propeller diameter in inches
2. Propeller pitch in inches
3. Type of propeller (propeller mark)

EMU25760

## Start-in-gear protection

Yamaha outboard motors affixed with the pictured label or Yamaha-approved remote control units are equipped with start-in-gear protection device(s). This feature permits the engine to be started only when it is in neutral. Always select neutral before starting the engine.

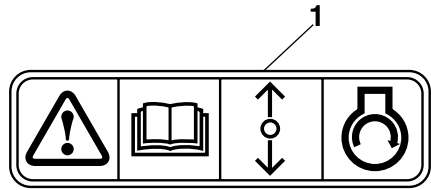

ZMU01713

1. Start-in-gear protection label

EMU37474

## Engine oil requirements

Recommended engine oil:  
4-stroke motor oil with a combination of the following SAE and API oil classifications

Engine oil type SAE:  
10W-30 or 10W-40

Engine oil grade API:  
SE, SF, SG, SH, SJ, SL

Total engine oil quantity (oil pan capacity):

- Without oil filter replacement:  
4.3 L (4.55 US qt, 3.78 Imp.qt)
- With oil filter replacement:  
4.5 L (4.76 US qt, 3.96 Imp.qt)

If the recommended engine oil grades are not available, select an alternative from the following chart according to the average temperatures in your area.

# Specifications and requirements

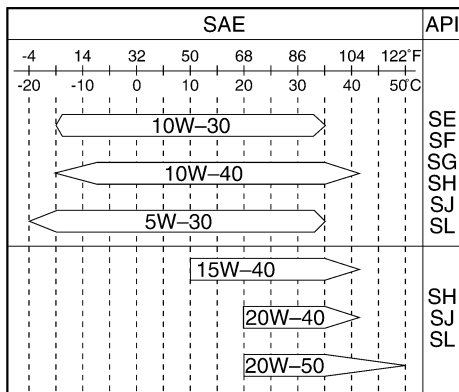

ZMU05190

EMU36360

## Fuel requirements

EMU36802

### Gasoline

Use a good quality gasoline that meets the minimum octane rating. If knocking or pinging occurs, use a different brand of gasoline or premium unleaded fuel.

Recommended gasoline:

Regular unleaded gasoline with a minimum octane rating of 90 (Research Octane Number).

ECM01981

### NOTICE

- Do not use leaded gasoline. Leaded gasoline can seriously damage the engine.
- Avoid getting water and contaminants in the fuel tank. Contaminated fuel can cause poor performance or engine damage. Use only fresh gasoline that has been stored in clean containers.

EMU36880

## Muddy or acidic water

Yamaha strongly recommends that you have your dealer install the optional chromium-plated water pump kit if you use the outboard mo-

tor in muddy or acidic water conditions. However, depending on the model it might not be required.

EMU36330

## Anti-fouling paint

A clean hull improves boat performance. The boat bottom should be kept as clean of marine growth as possible. If necessary, the boat bottom can be coated with an anti-fouling paint approved for your area to inhibit marine growth.

Do not use anti-fouling paint which includes copper or graphite. These paints can cause more rapid engine corrosion.

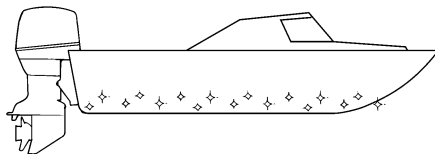

ZMU05176

EMU36341

## Motor disposal requirements

Never illegally discard (dump) the motor. Yamaha recommends consulting the dealer about discarding the motor.

EMU36351

## Emergency equipment

Keep the following items onboard in case there is trouble with the motor.

- A tool kit with assorted screwdrivers, pliers, wrenches (including metric sizes), and electrical tape.
- Waterproof flashlight with extra batteries.
- An extra engine shut-off cord (lanyard) with clip.
- Spare parts, such as an extra set of spark plugs.

Consult your Yamaha dealer for details.

# Components

EMU2579M

## Components diagram

### TIP:

\* May not be exactly as shown; also may not be included as standard equipment on all models.

**F80BET, F100DET**

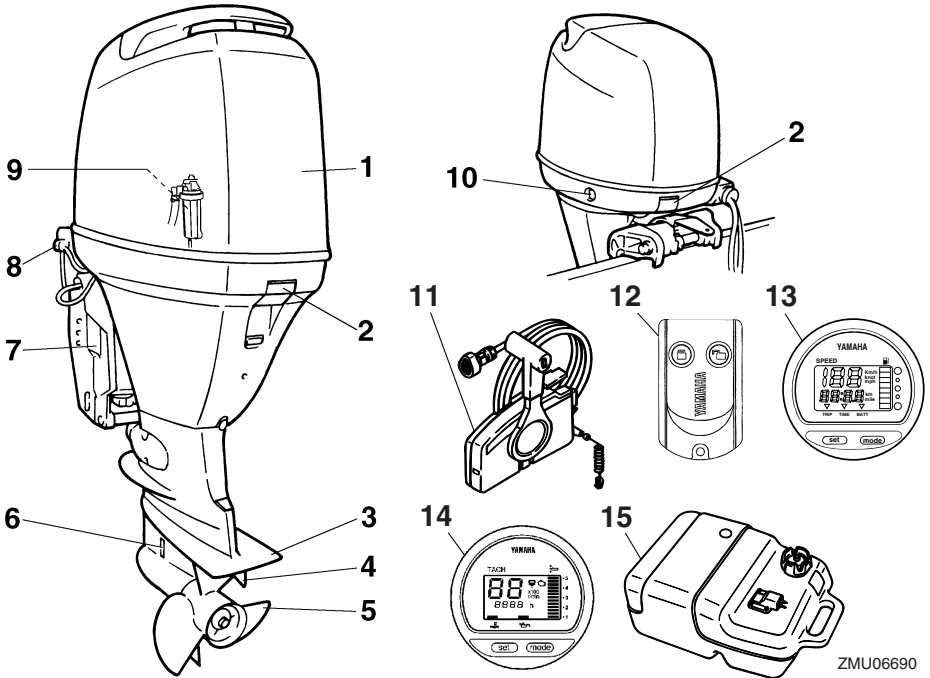

1. Top cowling
2. Cowling lock lever(s)
3. Anti-cavitation plate
4. Trim tab (anode)
5. Propeller\*
6. Cooling water inlet
7. Clamp bracket
8. Flushing device
9. Water separator
10. Power trim and tilt switch
11. Remote control box (side mount type)\*
12. Remote control transmitter
13. Digital speedometer\*
14. Digital tachometer\*
15. Fuel tank\*

## F80CED

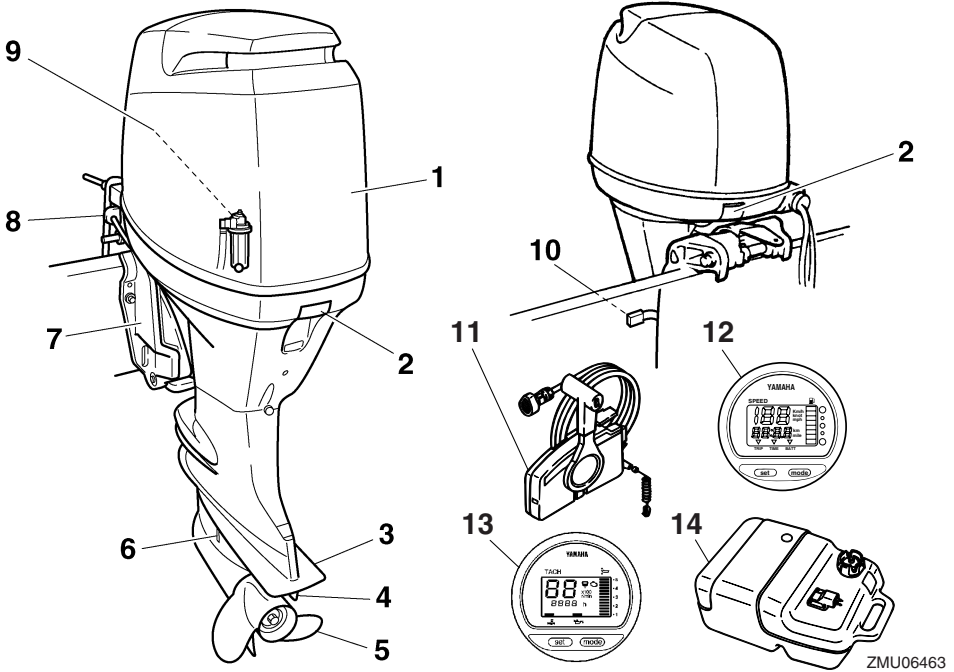

ZMU06463

1. Top cowling
2. Cowling lock lever(s)
3. Anti-cavitation plate
4. Trim tab (anode)
5. Propeller\*
6. Cooling water inlet
7. Clamp bracket
8. Flushing device
9. Water separator
10. Tilt lock lever
11. Remote control box (side mount type)\*
12. Digital speedometer\*
13. Digital tachometer\*
14. Fuel tank

# Components

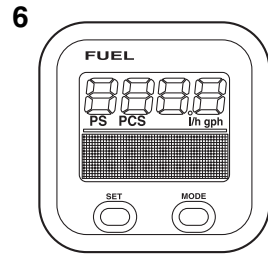
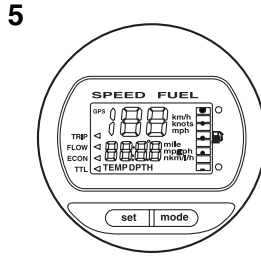
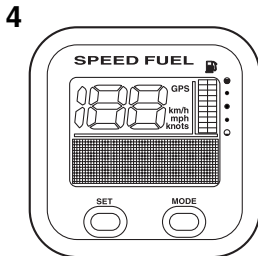
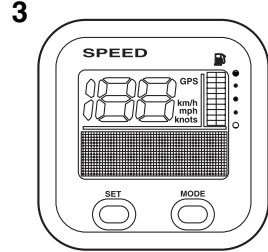
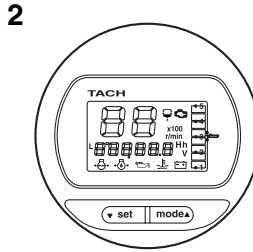
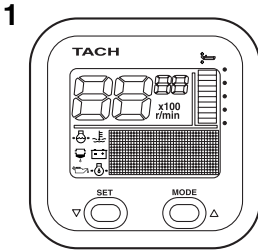

ZMU05429

1. Tachometer unit (Square type)\*
2. Tachometer unit (Round type)\*
3. Speedometer unit (Square type)\*
4. Speed & fuel meter unit (Square type)\*
5. Speed & fuel meter unit (Round type)\*
6. Fuel management meter (Square type)\*

EMU25802

## Fuel tank

If your model was equipped with a portable fuel tank, its function is as follows.

EWM00020

### WARNING

**The fuel tank supplied with this engine is its dedicated fuel reservoir and must not be used as a fuel storage container. Commercial users should conform to relevant licensing or approval authority regulations.**

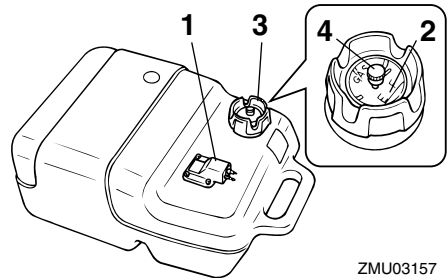

ZMU03157

1. Fuel joint
2. Fuel gauge
3. Fuel tank cap
4. Air vent screw

EMU25830

## Fuel joint

This joint is used to connect the fuel line.

EMU25841

## Fuel gauge

This gauge is located on either the fuel tank cap or on the fuel joint base. It shows the approximate amount of fuel remaining in the tank.

EMU25850

## Fuel tank cap

This cap seals the fuel tank. When removed, the tank can be filled with fuel. To remove the cap, turn it counterclockwise.

EMU25860

## Air vent screw

This screw is on the fuel tank cap. To loosen the screw, turn it counterclockwise.

EMU38590

## Remote control transmitter

The lock and unlock modes of the Yamaha Security System are selected using the remote control transmitter. While the engine is running, input from the remote control transmitter is not received.

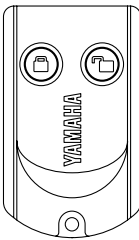

ZMU06455

Store the remote control transmitter carefully so it will not be lost.

ECM02100

## NOTICE

- **The remote control transmitter is not completely waterproof. Do not submerge the transmitter or operate it underwater. If the transmitter is submerged, dry it with a soft, dry cloth,**

**and then check that it is operating properly. If the transmitter is not operating properly, contact a Yamaha dealer.**

- **Keep the remote control transmitter away from high temperatures and do not place it in direct sunlight.**
- **Do not drop the remote control transmitter, subject it to strong shocks, or place any heavy items on it.**
- **Use a soft, dry cloth to clean the remote control transmitter. Do not use detergent, alcohol, or other chemicals.**
- **Do not attempt to disassemble the remote control transmitter yourself. Otherwise, the transmitter may not operate properly. If the transmitter needs a new battery, contact a Yamaha dealer.**
- **If you have lost the remote control transmitter, consult your Yamaha dealer. Keep the least 2 transmitters at all the time. If you have lost both transmitters, consult your Yamaha dealer.**

## TIP:

- Since the receiver is programmed to recognize the internal code from this transmitter only, the security system setting can only be changed with this transmitter. If the remote control transmitter does not operate properly, contact a Yamaha dealer.
- Replace the battery cell after 1 year, and every two years thereafter as a standard measure.
- Refer to local hazardous waste regulations when disposing of transmitter batteries.
- The Yamaha Security System permits to register up to 5 remote control transmitters. Consult your Yamaha dealer for details.

# Components

EMU38600

## Receiver

The receiver control the ECM (Electronic control module) to prevent the engine from starting. Consult your Yamaha dealer for installation of the receiver.

EMU38610

## Yamaha Security System lock and unlock mode

The Yamaha Security System settings are selected by pressing the lock or unlock button on the remote control transmitter briefly.

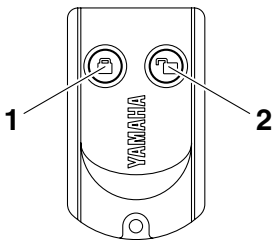

ZMU06456

1. Lock button
2. Unlock button

## LOCK

When the lock button on the remote control transmitter is pressed briefly, the beeper sounds once. This indicates the lock mode is selected and the engine cannot be started. The lock mode is selected only when the main switch is in the "OFF" (off) position. The engine cranks but can not be started while the Yamaha Security System is on lock mode.

## UNLOCK

When the unlock button on the remote control transmitter is pressed briefly, the beeper sounds twice. This indicates the unlock mode is selected and the engine can be started.

Yamaha Security System mode	Number of beeps	Main switch	Engine can be started
Lock	1 beep	"OFF"	NO
Unlock	2 beeps	"OFF"/ "ON"	YES

EMU26181

## Remote control box

The remote control lever actuates both the shifter and the throttle. The electrical switches are mounted on the remote control box.

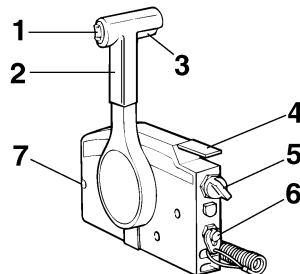

ZMU01723

1. Power trim and tilt switch
2. Remote control lever
3. Neutral interlock trigger
4. Neutral throttle lever
5. Main switch
6. Engine shut-off switch
7. Throttle friction adjuster

EMU26190

## Remote control lever

Moving the lever forward from the neutral position engages forward gear. Pulling the lever back from neutral engages reverse. The engine will continue to run at idle until the lever is moved about 35° (a detent can be felt). Moving the lever farther opens the throttle, and the engine will begin to accelerate.



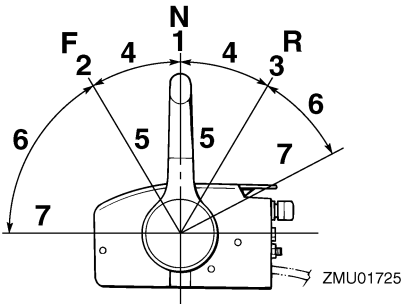

1. Neutral "N"
2. Forward "F"
3. Reverse "R"
4. Shift
5. Fully closed
6. Throttle
7. Fully open

EMU26201

## Neutral interlock trigger

To shift out of neutral, first pull the neutral interlock trigger up.

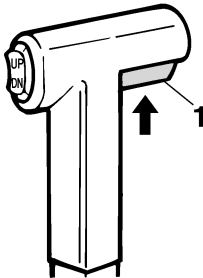

1. Neutral interlock trigger

EMU26212

## Neutral throttle lever

To open the throttle without shifting into either forward or reverse, put the remote control lever in the neutral position and lift the neutral throttle lever.

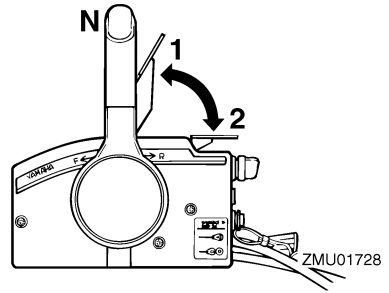

1. Fully open
2. Fully closed

## TIP:

The neutral throttle lever will operate only when the remote control lever is in neutral. The remote control lever will operate only when the neutral throttle lever is in the closed position.

EMU25911

## Tiller handle

To change direction, move the tiller handle to the left or right as necessary.

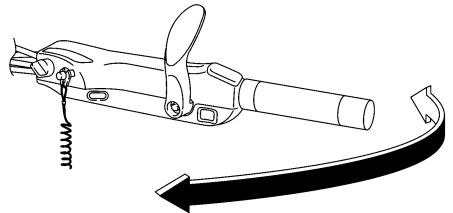

ZMU05203

EMU25922

## Gear shift lever

Pulling the gear shift lever towards you puts the engine in forward gear so that the boat moves ahead. Pushing the lever away from you puts the engine in reverse gear so that the boat moves astern.

# Components

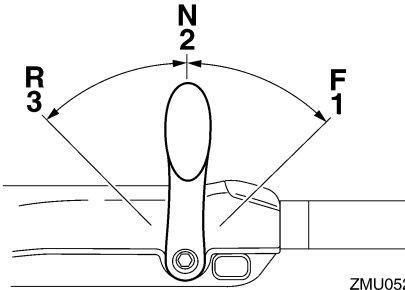

ZMU05204

1. Forward "F"
2. Neutral "N"
3. Reverse "R"

EMU25941

## Throttle grip

The throttle grip is on the tiller handle. Turn the grip counterclockwise to increase speed and clockwise to decrease speed.

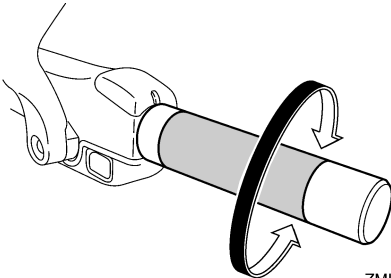

ZMU05205

EMU25961

## Throttle indicator

The fuel consumption curve on the throttle indicator shows the relative amount of fuel consumed for each throttle position. Choose the setting that offers the best performance and fuel economy for the desired operation.

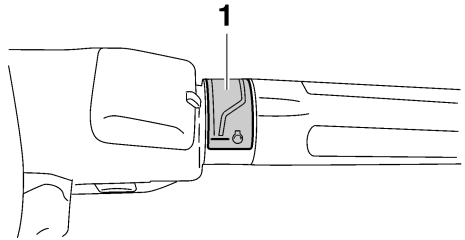

ZMU05206

1. Throttle indicator

EMU25976

## Throttle friction adjuster

A friction device provides adjustable resistance to movement of the throttle grip or the remote control lever, and can be set according to operator preference.

To increase resistance, turn the adjuster clockwise. To decrease resistance, turn the adjuster counterclockwise. **WARNING! Do not overtighten the friction adjuster. If there is too much resistance, it could be difficult to move the remote control lever or throttle grip, which could result in an accident.** [EWM00032]

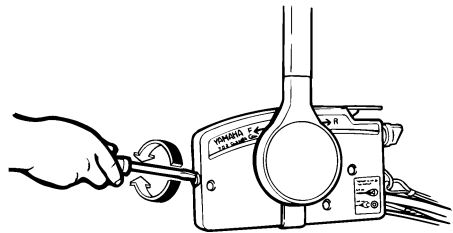

ZMU01714

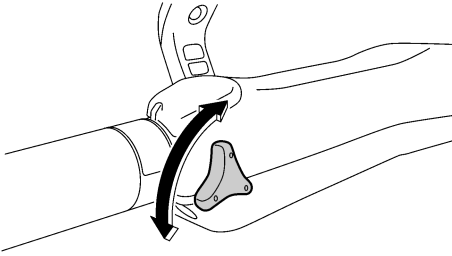

ZMU05207

When constant speed is desired, tighten the adjuster to maintain the desired throttle setting.

EMU25994

## Engine shut-off cord (lanyard) and clip

The clip must be attached to the engine shut-off switch for the engine to run. The cord should be attached to a secure place on the operator's clothing, or arm or leg. Should the operator fall overboard or leave the helm, the cord will pull out the clip, stopping ignition to the engine. This will prevent the boat from running away under power. **WARNING! Attach the engine shut-off cord to a secure place on your clothing, or your arm or leg while operating. Do not attach the cord to clothing that could tear loose. Do not route the cord where it could become entangled, preventing it from functioning. Avoid accidentally pulling the cord during normal operation. Loss of engine power means the loss of most steering control. Also, without engine power, the boat could slow rapidly. This could cause people and objects in the boat to be thrown forward.**

[EWM00122]

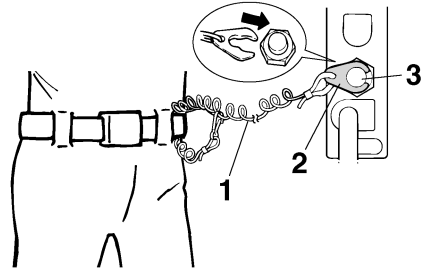

ZMU01716

1. Cord
2. Clip
3. Engine shut-off switch

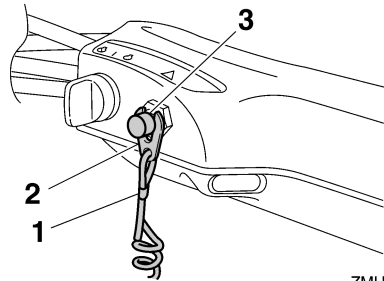

ZMU05208

1. Cord
2. Clip
3. Engine shut-off switch

EMU26001

## Engine stop button

To open the ignition circuit and stop the engine, push this button.

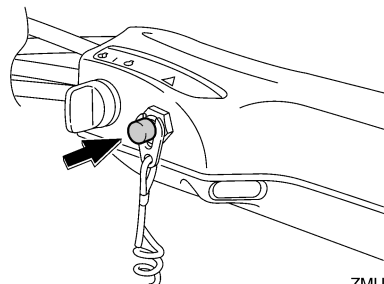

ZMU05209

# Components

EMU26091

## Main switch

The main switch controls the ignition system; its operation is described below.

- “OFF” (off)

With the main switch in the “OFF” (off) position, the electrical circuits are off, and the key can be removed.

- “ON” (on)

With the main switch in the “ON” (on) position, the electrical circuits are on, and the key cannot be removed.

- “START” (start)

With the main switch in the “START” (start) position, the starter motor turns to start the engine. When the key is released, it returns automatically to the “ON” (on) position.

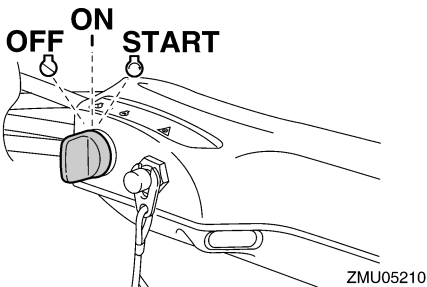
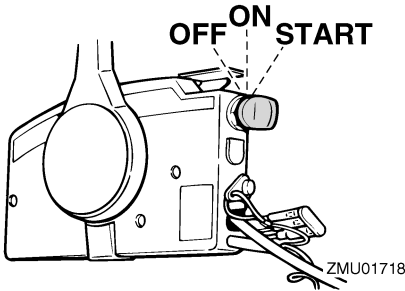

EMU26111

## Steering friction adjuster

A friction device provides adjustable resistance to the steering mechanism, and can be set according to operator preference. An adjuster lever is located on the bottom of the tiller handle bracket.

To increase resistance, turn the lever to the port side “A”.

To decrease resistance, turn the lever to the starboard side “B”.

EWM00040

### **WARNING**

**Do not overtighten the friction adjuster. If there is too much resistance, it could be difficult to steer, which could result in an accident.**

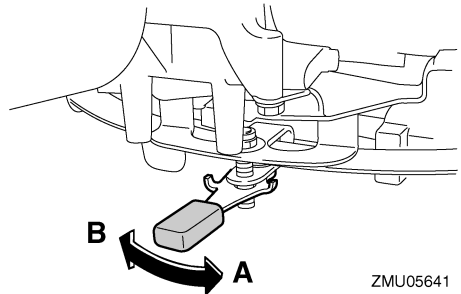

### TIP:

- Check the tiller handle for smooth movement when the lever is turned to the starboard side “B”.
- Do not apply lubricants such as grease to the friction areas of the steering friction adjuster.

EMU26143

## Power trim and tilt switch on remote control or tiller handle

The power trim and tilt system adjusts the outboard motor angle in relation to the transom. Pressing the switch “UP” (up) trims the outboard motor up, and then tilts it up. Pressing

the switch “DN” (down) tilts the outboard motor down and trims it down. When the switch is released, the outboard motor will stop in its current position.

For instructions on using the power trim and tilt switch, see pages 55 and 58.

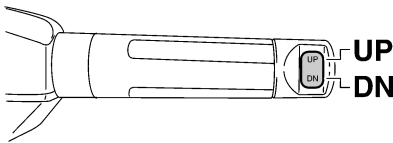
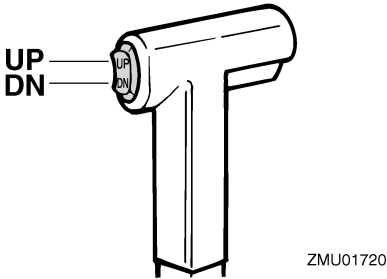

EMU26153

## Power trim and tilt switch on bottom engine cowling

The power trim and tilt switch is located on the side of the bottom engine cowling. Pressing the switch “UP” (up) trims the outboard motor up, and then tilts it up. Pressing the switch “DN” (down) tilts the outboard motor down and trims it down. When the switch is released, the outboard motor will stop in its current position.

For instructions on using the power trim and tilt switch, see page 58.

EWMO1030

## WARNING

Use the power trim and tilt switch located on the bottom engine cowling only when the boat is at a complete stop with the engine off. Attempting to use this switch while the boat is moving could increase the risk of falling overboard and could distract the operator, increasing the risk of collision with another boat or an obstacle.

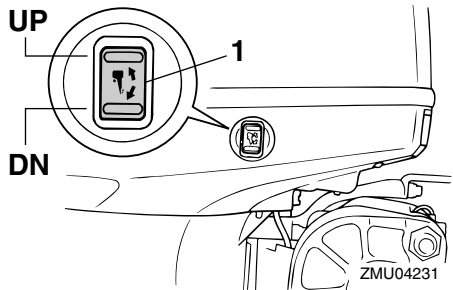

1. Power trim and tilt switch

EMU30901

## Variable trolling RPM switches

The trolling speed can be adjusted when the outboard motor is trolling. Press the “UP” switch to increase the trolling speed and press the “DN” switch to decrease the trolling speed.

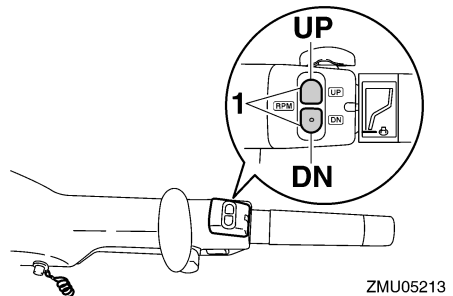

1. Variable trolling RPM switch

# Components

## TIP:

- The trolling speed changes approximately 50 r/min each time a switch is pressed.
- If the trolling speed has been adjusted, the engine returns to the normal trolling speed when the engine is stopped and restarted or when the engine speed exceeds approximately 3000 r/min.
- For instructions on using the variable trolling RPM switches, see page 54.

EMU26244

## Trim tab with anode

EWM00840

### **WARNING**

An improperly adjusted trim tab could cause difficult steering. Always test run after the trim tab has been installed or replaced to be sure steering is correct. Be sure you have tightened the bolt after adjusting the trim tab.

The trim tab should be adjusted so that the steering control can be turned to either the right or left by applying the same amount of force.

If the boat tends to veer to the left (port side), turn the trim tab rear end to the port side "A" in the figure. If the boat tends to veer to the right (starboard side), turn the trim tab end to the starboard side "B" in the figure.

ECM00840

### **NOTICE**

The trim tab also serves as an anode to protect the engine from electrochemical corrosion. Never paint the trim tab as it will become ineffective as an anode.

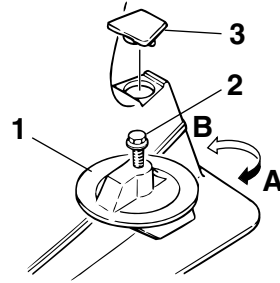

ZMU02525

1. Trim tab
2. Bolt
3. Cap

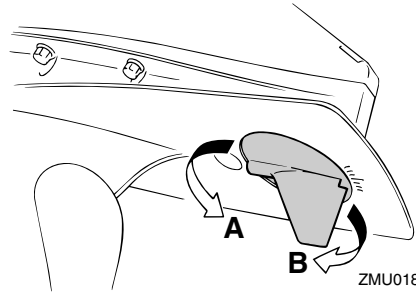

ZMU01863

### Bolt tightening torque:

F80BET, F100DET

35.0 Nm (3.57 kgf-m, 25.8 ft-lb)

F80CED

42.0 Nm (4.28 kgf-m, 31.0 ft-lb)

EMU32070

## Trim angle adjusting bolts

The positions of the trim angle adjusting bolts determine the minimum trim angle of the outboard motor in relation to the transom.

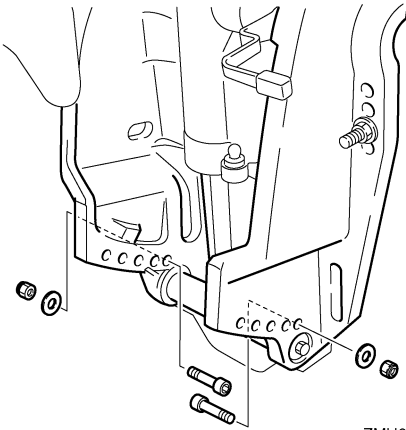

ZMU05643

EMU26312

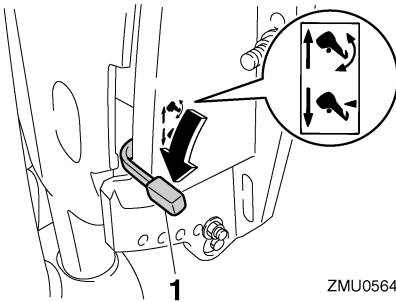

## Tilt lock mechanism

The tilt lock mechanism is used to prevent the outboard motor from lifting out of the water when in reverse gear.



ZMU05644

1. Tilt lock lever

To lock it, set the tilt lock lever in the “” (lock) position. To release, push the tilt lock lever in the “” (release) position.

EMU34461

## Tilt support lever for power trim and tilt or hydro tilt model

To keep the outboard motor in the tilted up position, lock the tilt support lever to the clamp bracket.

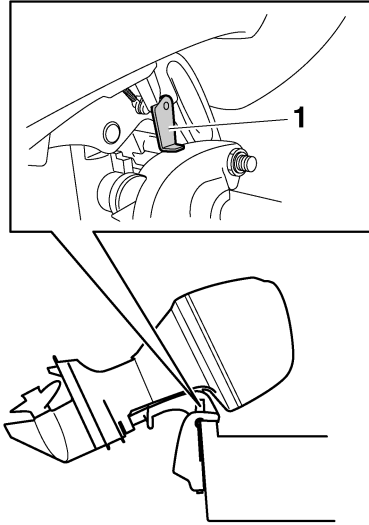

ZMU05661

1. Tilt support lever

ECM00660

## NOTICE

**Do not use the tilt support lever or knob when trailering the boat. The outboard motor could shake loose from the tilt support and fall. If the motor cannot be trailered in the normal running position, use an additional support device to secure it in the tilt position.**

EMU26383

## Cowling lock lever (pull up type)

To remove the engine top cowling, pull up the cowling lock lever(s) and lift off the cowling. When installing the cowling, check to be sure it fits properly in the rubber seal. Then lock the cowling by moving the cowling lock lever(s) downward.

# Components

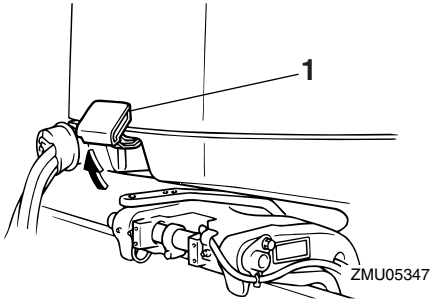

1. Cowling lock lever(s)

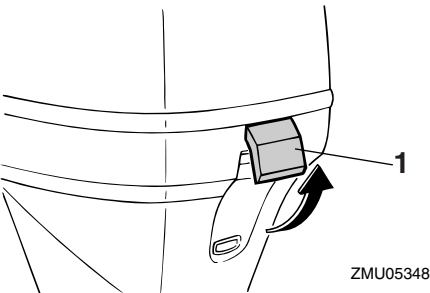

1. Cowling lock lever(s)

EMU26461

## Flushing device

This device is used to clean the cooling water passages of the motor using a garden hose and tap water.

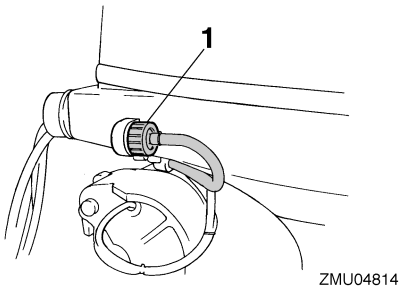

1. Flushing device

## TIP:

For details on usage, see page 67.

EMU35561

## Fuel filter/Water separator

This engine has a combination fuel filter/water separator and associated alert system. If water separated from the fuel exceeds a specific volume, the alert device of 6Y8 Multifunction Tachometer will activate.

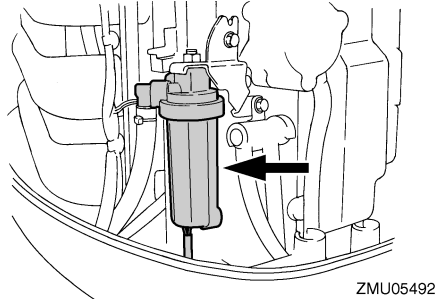

## Activation of alert device

- The water separator-alert indicator of 6Y8 Multifunction Tachometer will blink.
- The buzzer will sound intermittently only when the gear shift is in neutral.
- If the alert system has activated, stop the engine and consult a Yamaha dealer immediately.

EMU26303

## Alert indicator

If the engine develops a condition which is cause for alert, the indicator lights up. For details on how to read the alert indicator, see page 38.

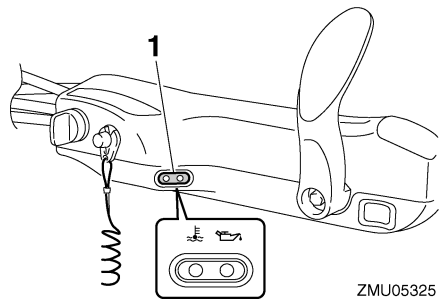

1. Alert indicator



# Instruments and indicators

EMU36014

## Indicators

EMU36024

### Low oil pressure-alert indicator

If oil pressure drops too low, this indicator will light up. For further information, see page 38.

ECM00022

#### NOTICE

- Do not continue to run the engine if the low oil pressure-alert indicator is on and the engine oil level is lower. Serious engine damage will occur.
- The low oil pressure-alert indicator does not indicate the engine oil level. Use the oil dipstick to check the remaining oil quantity. For further information, see page 44.

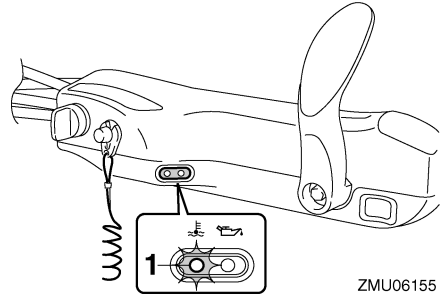

1. Overheat-alert indicator

EMU31414

### Digital tachometer

The tachometer shows the engine speed and has the following functions.

All segments of the display will light momentarily after the main switch is turned on and will return to normal thereafter.

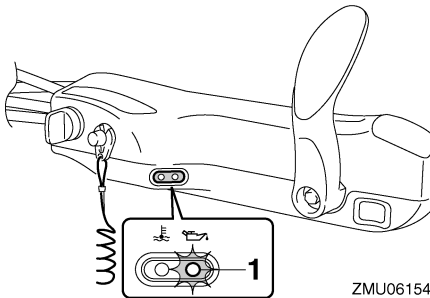

1. Low oil pressure-alert indicator

EMU36033

### Overheat-alert indicator

If the engine temperature rises too high, this indicator will light up. For further information on reading the indicator, see page 38.

ECM00052

#### NOTICE

Do not continue to run the engine if the overheat-alert indicator is on. Serious engine damage will occur.

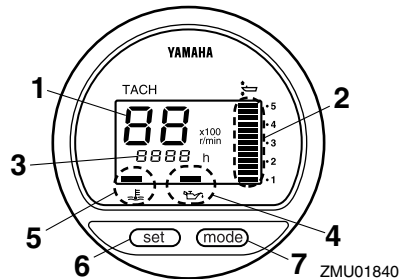

1. Tachometer
2. Trim meter
3. Hour meter
4. Low oil pressure-alert indicator
5. Overheat-alert indicator
6. Set button
7. Mode button

#### TIP:

The water separator-alert indicator and engine trouble-alert indicator on the digital tachometer do not operate for this engine.

# Instruments and indicators

EMU36050

## Tachometer

The tachometer displays engine speed in hundreds of revolutions per minute (r/min). For example, if the tachometer display reads “22” then the engine speed is 2200 r/min.

EMU26621

## Trim meter

This meter shows the trim angle of your outboard motor.

- Memorize the trim angles that work best for your boat under different conditions. Adjust the trim angle to the desired using the power trim and tilt switch.
- If the trim angle of your motor exceeds the trim operating range, the top segment on the trim meter display will blink.

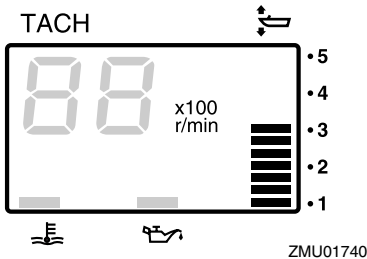

EMU26651

## Hour meter

This meter shows the number of hours the engine has been run. It can be set to show the total number of hours or the number of hours for the current trip. The display can also be turned on and off.

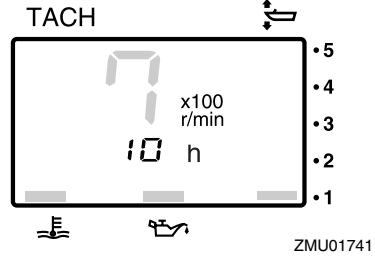

To change the display format, press the “mode” (mode) button. The display can show total hours or trip hours, or turn off.

To reset the trip hours, simultaneously press the “set” (set) and “mode” (mode) buttons for more than 1 second while the trip hours are displayed. This resets the trip counter to 0 (zero).

The total number of hours the engine has been run cannot be reset.

EMU26524

## Low oil pressure-alert indicator

If oil pressure drops too low, the alert indicator will start to blink. For further information, see page 38.

ECM00022

### NOTICE

- Do not continue to run the engine if the low oil pressure-alert indicator is on and the engine oil level is lower. Serious engine damage will occur.
- The low oil pressure-alert indicator does not indicate the engine oil level. Use the oil dipstick to check the remaining oil quantity. For further information, see page 44.

# Instruments and indicators

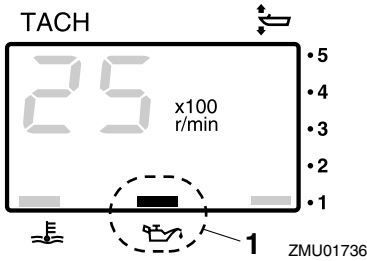

1. Low oil pressure-alert indicator

EMU26583

## Overheat-alert indicator

If the engine temperature rises too high, the alert indicator will start to blink. For further information on reading the indicator, see page 38.

ECM00052

### NOTICE

**Do not continue to run the engine if the overheat-alert indicator is on. Serious engine damage will occur.**

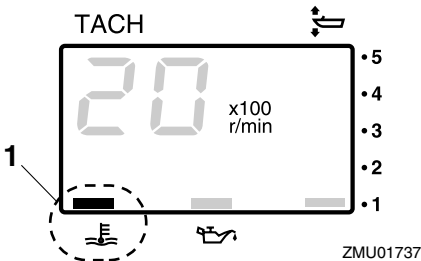

1. Overheat-alert indicator

EMU26602

## Digital speedometer

This gauge shows the boat speed and other information.

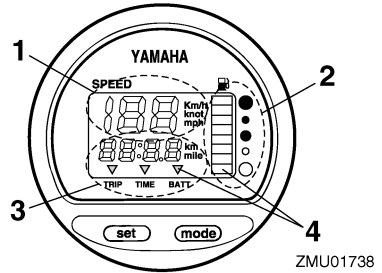

ZMU01738

1. Speedometer
2. Fuel gauge
3. Trip meter/clock/voltmeter
4. Alert indicator(s)

All segments of the display will light momentarily after the main switch is turned on and will return to normal thereafter.

EMU36061

## Speedometer

The speedometer displays km/h, mph, or knots, according to operator preference. Select the desired units of measurement by setting the selector switch on the back of the gauge. See the illustration for settings.

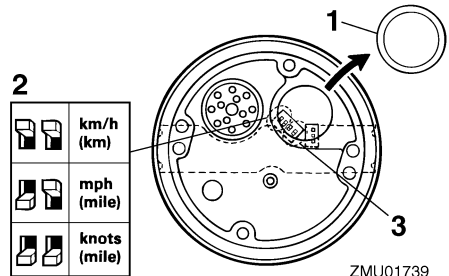

ZMU01739

1. Cap
2. Selector switch (for speed unit)
3. Selector switch (for fuel sensor)

EMU26712

## Fuel gauge

Eight segments indicate the fuel level. When all segments are showing, the fuel tank is full.

# Instruments and indicators

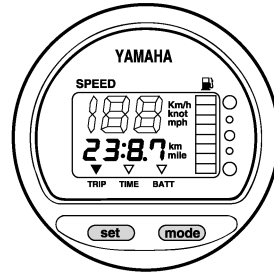
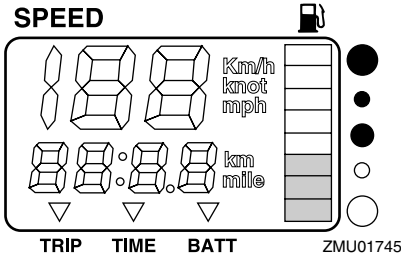

The fuel level reading can be inaccurate due to by the position of the sensor in the fuel tank and the attitude of the boat in the water. Operation with bow-up trim or continuous turning can give false readings.

Do not adjust the selector switch for fuel sensor. Incorrectly setting the selector switch on the gauge will give false readings. Consult your Yamaha dealer on how to correctly set the selector switch. **NOTICE: Running out of fuel can damage the engine.** [ECM01770]

EMU36071

## Trip meter / Clock / Voltmeter

The display shows either the trip meter, the clock, or the voltmeter.

To change the display, press the “mode” (mode) button repeatedly until the indicator on the face of the gauge points to “TRIP” (trip meter), “TIME” (clock), or “BATT” (voltmeter).

EMU26691

### Trip meter

This gauge displays the distance the boat has traveled since the gauge was last reset.

The trip distance is shown in kilometers or miles depending upon the unit of measurement selected for the speedometer.

To reset the trip meter to zero, press the “set” (set) and “mode” (mode) buttons at the same time.

The trip distance is kept in memory by battery power. The stored data will be lost if the battery is disconnected.

EMU26701

### Clock

To set the clock:

1. Be sure the gauge is in the “TIME” (time) mode.
2. Press the “set” (set) button; the hour display will begin blinking.
3. Press the “mode” (mode) button until the desired hour is displayed.
4. Press the “set” (set) button again, the minute display will begin blinking.
5. Press the “mode” (mode) button until the desired minute is displayed.
6. Press the “set” (set) button again to start the clock.

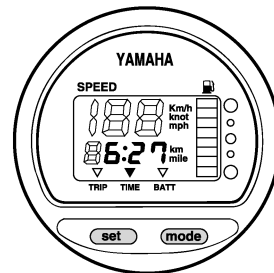

The clock operates on battery power. Disconnecting the battery will stop the clock. Reset the clock after connecting the battery.

EMU36080

### Voltmeter

The voltmeter displays the charge of the battery in volts(V).

# Instruments and indicators

EMU26721

## Fuel level-alert indicator

If the fuel level decreases to one segment, the fuel level alert segment will blink.

Do not continue to operate the engine with full throttle if an alert device has activated. Get back to the port within trolling engine speed.

**NOTICE: Running out of fuel can damage the engine.** [ECM01770]

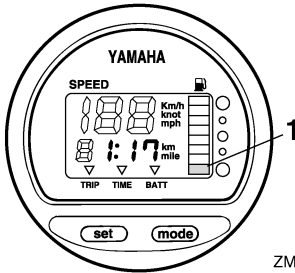

1. Fuel level-alert segment

EMU26732

## Low battery voltage-alert indicator

If battery voltage drops, the display will automatically turn on and blink.

Get back to the port soon if an alert device has activated. For charging the battery, consult your Yamaha dealer.

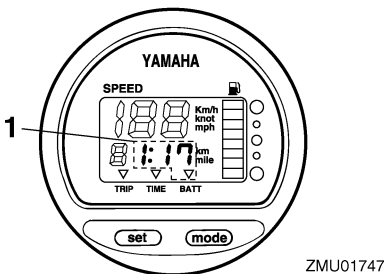

1. Low battery indicator

EMU26641

## Hour meter

The digital hour meter is mounted on the engine inside the top cowling. It measures the total number of hours the engine has been run

since manufacture. When the main switch is turned on, initially all segments of the display will light. The indicator will then display the number of hours normally.

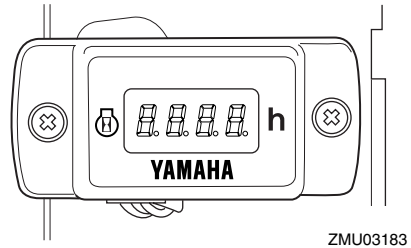

### TIP:

The number of hours is only measured when the engine is running. When the main switch is turned on but the engine is not running, the digital hour meter will display the hours run but will not add any additional time to the total.

EMU31653

## 6Y8 Multifunction meters

Multifunction meters have 6 kinds of meter units; tachometer unit (square or round types), speedometer unit (square type), speed & fuel meter unit (square or round types), and fuel management meter (square type). The indicator system is slightly different between the round and square types. Check the model and type of your unit carefully. This manual describes mainly the alert indicators. For more details on setting meters or changing indicator systems, see the attached operation manual.

EMU36184

## 6Y8 Multifunction tachometers

The tachometer shows the engine revolutions per minute. It has functions of trim meter, adjusting trolling speed, cooling water/engine temperature display, battery voltage display, total hour/trip hour display, oil pressure dis-

# Instruments and indicators

play, water detection alert, engine trouble alert, and periodic maintenance notification. If the cooling water pressure sensor is installed, the unit can also show the cooling water pressure display. However, even if the cooling water pressure sensor is not installed, the cooling water pressure display can be shown by connecting an optional sensor to the unit. For the optional sensor, consult your Yamaha dealer. The tachometer unit is available in round or square types. Check your tachometer unit type.

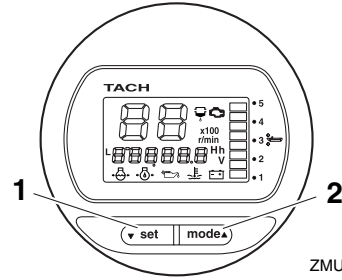

ZMU05417

1. Set button
2. Mode button

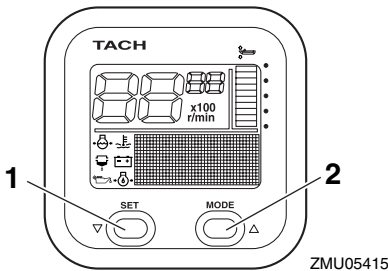

ZMU05415

1. Set button
2. Mode button

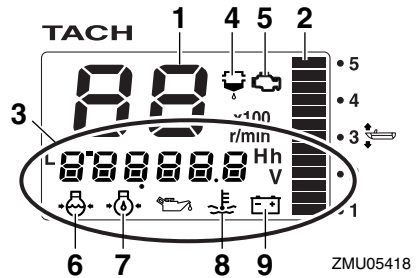

ZMU05418

1. Tachometer
2. Trim meter
3. Multifunction display
4. Water detection-alert indicator
5. Engine trouble alert/maintenance indicator
6. Cooling water pressure
7. Oil pressure (4-stroke models)
8. Cooling water/engine temperature
9. Battery voltage

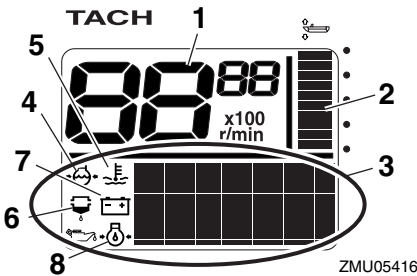

ZMU05416

1. Tachometer
2. Trim meter
3. Multifunction display
4. Cooling water pressure
5. Cooling water/engine temperature
6. Water detection-alert indicator
7. Battery voltage
8. Oil pressure (4-stroke models)

EMU36190

## Start-up checks

Place the remote control lever / gear shift lever in neutral and turn the main switch to "ON" (on). After all the displays come on and the total hour display comes on, the gauge will change to normal operation. If the buzzer sounds and the water separator-alert indicator blinks, consult your Yamaha dealer immediately.

# Instruments and indicators

## TIP:

To stop the buzzer, press the “set” (set) or “mode” (mode) button.

EMU38620

## Yamaha Security System information

Turn the main switch to the “ON” (on) position, the currently selected Yamaha Security System mode (Lock / Unlock) will show on the display.

### Unlock mode

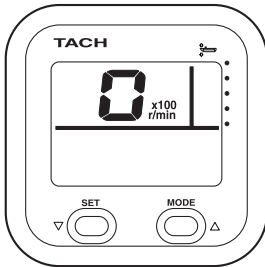

ZMU06457

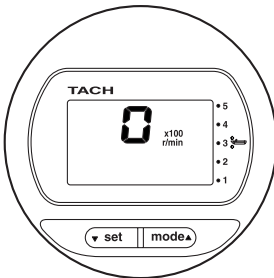

ZMU06458

### Lock mode

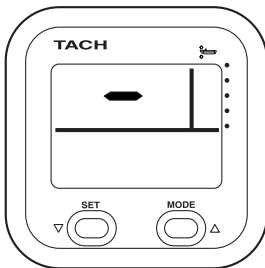

ZMU06459

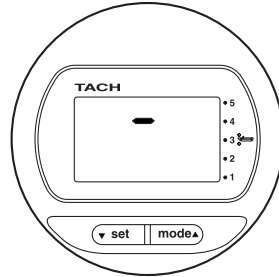

ZMU06460

EMU36130

## Low oil pressure-alert

If the engine oil pressure drops too low, the low oil pressure-alert indicator will start to blink, and the engine speed will automatically decrease to about 2000 r/min.

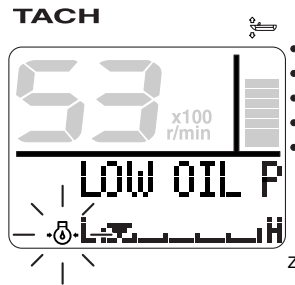

ZMU05430

## TACH

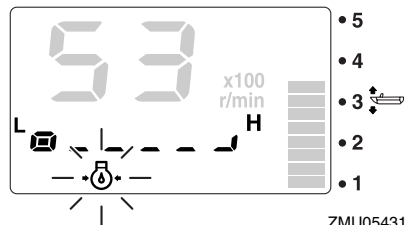

ZMU05431

Stop the engine immediately if the buzzer sounds and the low oil pressure-alert indicator blinks. Check the engine oil quantity and replenish oil if necessary. If the alert device has

# Instruments and indicators

activated while the appropriate engine oil quantity is maintained, consult your Yamaha dealer.

ECM01601

## NOTICE

**Do not continue to run the engine if the low oil pressure alert device has activated. Serious engine damage will occur.**

EMU36221

## Overheat alert

If the engine temperature rises too high while cruising, the overheat-alert indicator will start to blink. The engine speed will automatically decrease to about 2000 r/min.

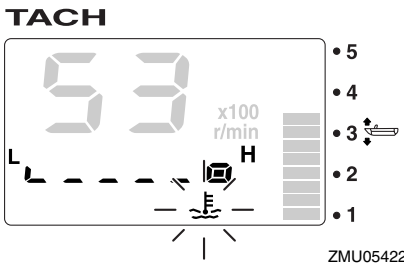
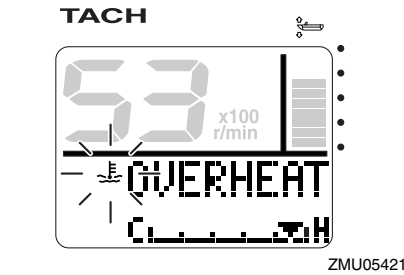

Stop the engine immediately if the buzzer sounds and the overheat alert device has activated. Check the cooling water inlet for clogging.

ECM01592

## NOTICE

- Do not continue to run the engine if the overheat-alert indicator blinks. Serious engine damage will occur.
- Do not continue to operate the engine if a alert device has activated. Consult your Yamaha dealer if the problem cannot be located and corrected.

EMU36150

## Water separator alert

This indicator will blink if water has accumulated in the water separator (fuel filter) while cruising. In such an event, stop the engine immediately and see page 87 of this manual to drain the water from the fuel filter. Get back to the port soon and consult a Yamaha dealer immediately.

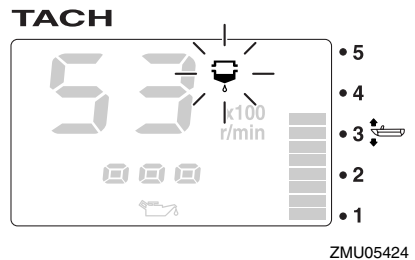
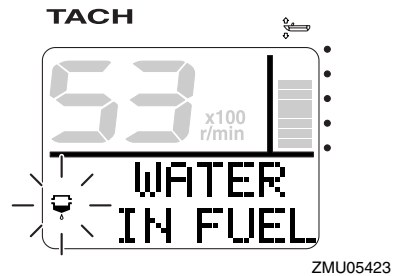



# Instruments and indicators

ECM00910

## NOTICE

**Gasoline mixed with water could cause damage to the engine.**

EMU36160

## Engine trouble alert

This indicator will blink if the engine malfunctions while cruising. Get back to the port soon and consult a Yamaha dealer immediately.

TACH

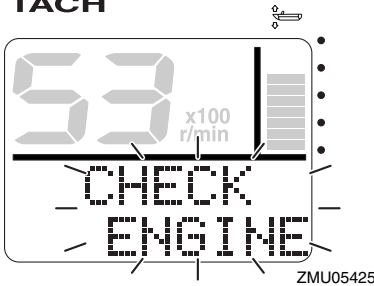

TACH

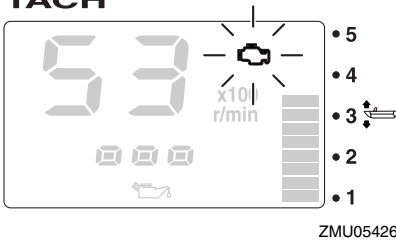

ECM00920

## NOTICE

**In such an event, the engine will not operate properly. Consult a Yamaha dealer immediately.**

EMU36170

## Low battery voltage-alert

If the battery voltage drops, the low battery voltage-alert indicator and the battery voltage value will start to blink. Get back to the port

soon if the low battery voltage-alert device has activated. For charging the battery, consult your Yamaha dealer.

TACH

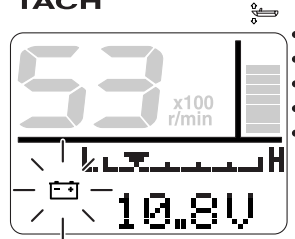

TACH

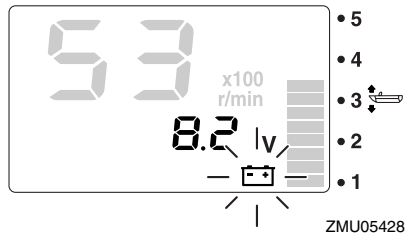

EMU36232

## 6Y8 Multifunction speed & fuel meters

The speed & fuel meter unit shows the boat speed and has the functions of fuel meter, total fuel consumption display, fuel economy display, fuel flow display, and system voltage display. The chosen display is selected by using the “set” (set) and “mode” (mode) buttons as described in this section. If the speed sensor is installed, the unit can also show the trip display. However, even if the speed sensor is not installed, the trip display can be shown by connecting an optional sensor to the unit. In addition, if optional sensors are connected to the unit, water surface temperature display,

# Instruments and indicators

depth display, and clock will also be available. For the optional sensors, consult your Yamaha dealer.

The speed & fuel meter unit is available in round or square types. Check your speed & fuel meter unit type for operation information. After the main switch is first turned on, all the displays come on as a test. After a few seconds, the gauge will change to normal operation.

For more information, see the operation manual originally supplied with the meter.

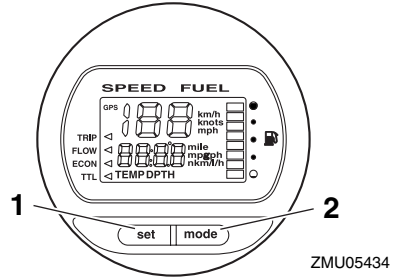

1. Set button
2. Mode button

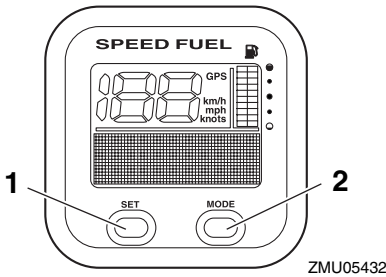

1. Set button
2. Mode button

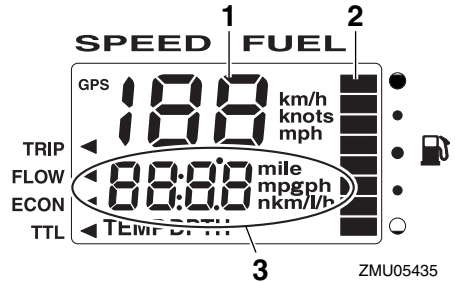

1. Speedometer
2. Fuel meter
3. Multifunction display

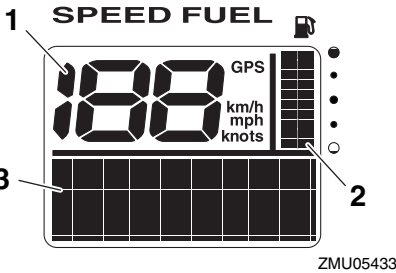

1. Speedometer
2. Fuel meter
3. Multifunction display

EMU36241

## 6Y8 Multifunction speedometers

The speedometer unit shows the boat speed and has functions of fuel meter and system voltage display. The chosen display is selected by using the “set” (set) and “mode” (mode) buttons as described in this section. In addition, the speedometer can show the desired unit of measurement such as km/h, mph, or knots. If the speed sensor is installed, the unit can also show the trip display. However, even if the speed sensor is not installed, the trip display can be shown by connecting an optional sensor to the unit. In addition, if optional sensors are connected to the unit, water surface

# Instruments and indicators

temperature display, depth display, and clock will also be available. For the optional sensors, consult your Yamaha dealer.

After the main switch is first turned on, all the displays come on as a test. After a few seconds, the gauge will change to normal operation.

For more information, see the operation manual originally supplied with the meter.

buttons as described in this section. For more information, see the operation manual originally supplied with the meter.

After the main switch is first turned on, all the displays come on as a test. After a few seconds, the gauge will change to normal operation.

For more information, see the operation manual originally supplied with the meter.

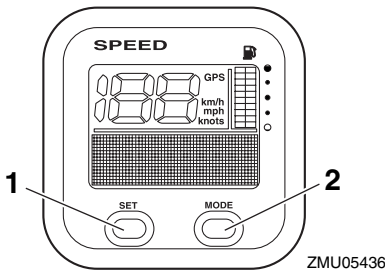

1. Set button
2. Mode button

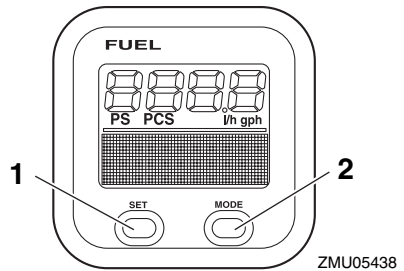

1. Set button
2. Mode button

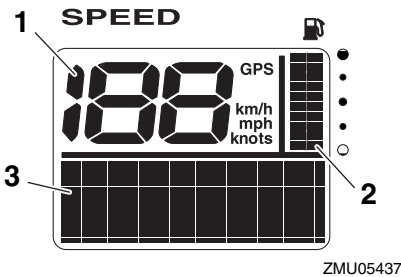

1. Speedometer
2. Fuel meter
3. Multifunction display

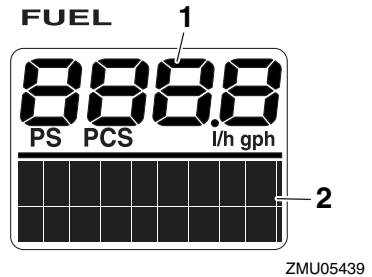

1. Fuel flow meter
2. Multifunction display

EMU36250

## 6Y8 Multifunction fuel management meters

The fuel management meter has the functions of fuel flow meter, total consumption display, fuel economy display, and remaining fuel display. The chosen display is selected by using the "set" (set) and "mode" (mode)

# Engine control system

EMU26803

## Alert system

ECMQ0091

### NOTICE

Do not continue to operate the engine if a alert device has activated. Consult your Yamaha dealer if the problem cannot be located and corrected.

EMU2681A

### Overheat alert

This engine has an overheat-alert device. If the engine temperature rises too high, the alert device will activate.

- The engine speed will automatically decrease to about 2000 r/min.
- The overheat-alert indicator will light or blink.

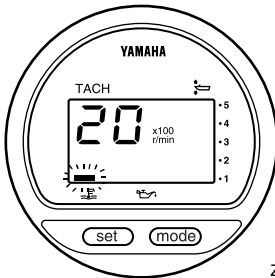

ZMU01757

- The buzzer will sound (if equipped on the tiller handle, remote control box, or main switch panel).

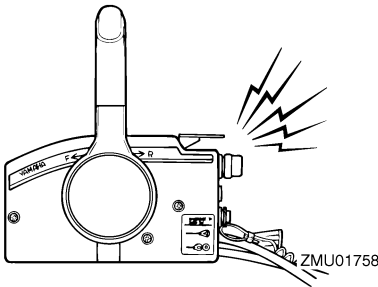

ZMU01758

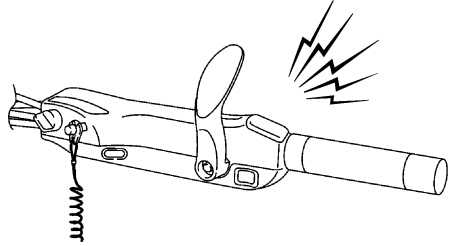

ZMU05326

If the alert system has activated, stop the engine and check the cooling water inlets:

- Check trim angle to be sure that the cooling water inlet is submerged.
- Check the cooling water inlet for clogging.

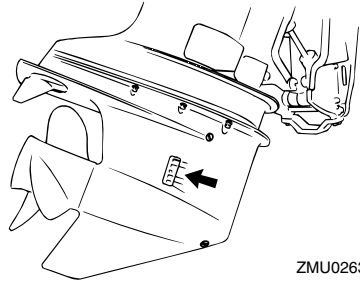

ZMU02630

EMU26857

### Low oil pressure alert

If the oil pressure drops too low, the alert device will activate.

- The engine speed will automatically decrease to about 2000 r/min. The low oil pressure-alert indicator will light or blink.

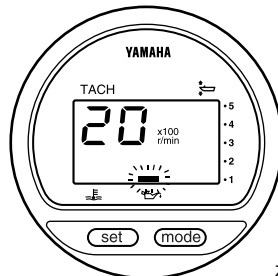

ZMU01828

# Engine control system

- The buzzer will sound.

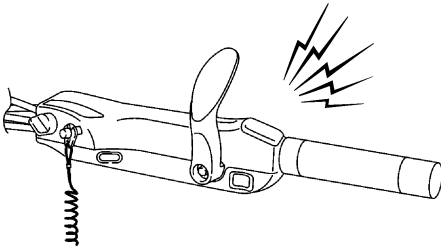
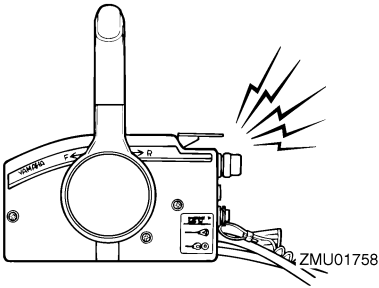

ZMU05326

If the alert system has activated, stop the engine as soon as it is safe to do so. Check the oil level and add oil as needed. If the oil level is correct and the alert device does not switch off, consult your Yamaha dealer.

# Installation

EMU26902

## Installation

The information presented in this section is intended as reference only. It is not possible to provide complete instructions for every possible boat and motor combination. Proper mounting depends in part on experience and the specific boat and motor combination.

EWMO1590

### **WARNING**

- **Overpowering a boat could cause severe instability. Do not install an outboard motor with more horsepower than the maximum rating on the capacity plate of the boat. If the boat does not have a capacity plate, consult the boat manufacturer.**
- **Improper mounting of the outboard motor could result in hazardous conditions such as poor handling, loss of control, or fire hazards. For permanently mounted models, your dealer or other person experienced in proper rigging should mount the motor.**

EMU33470

## Mounting the outboard motor

The outboard motor should be mounted so that the boat is well balanced. Otherwise, the boat could be hard to steer. For single-engine boats, mount the outboard motor on the centerline (keel line) of the boat.

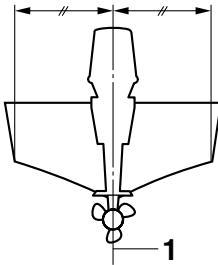

ZMU01760

1. Center line (keel line)

EMU26932

## Mounting height (boat bottom)

The mounting height of your outboard motor affects its efficiency and reliability. If it is mounted too high, propeller ventilation may occur, which will reduce propulsion due to excessive propeller slip, and the water intakes for the cooling system may not get adequate water supply, which can cause engine overheating. If the engine is mounted too low, water resistance (drag) will increase, thereby reducing engine efficiency and performance. Most commonly, outboard motor should be mounted so that the anti-cavitation plate is in alignment with the bottom of the boat. The optimum mounting height of the outboard motor is affected by the boat/motor combination and the desired use. Test runs at different heights can help determine the optimum mounting height. Consult your Yamaha dealer or boat manufacturer for further information on determining the proper mounting height.

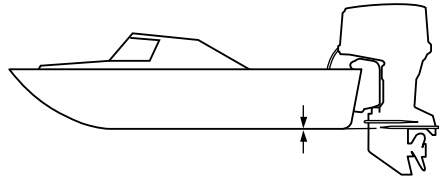

ZMU01762

ECM01631

### **NOTICE**

- **Check that the idle hole stays high enough to keep out water getting inside engine even if the boat is in stationary with maximum load.**
- **Incorrect engine height or obstructions to the smooth flow of water (such as the design or condition of the boat, or accessories such as transom ladders or**

depth finder transducers) can create airborne water spray while the boat is cruising. If the motor is operated continuously in the presence of airborne water spray, enough water could enter the engine through the intake opening on the cowling to cause severe engine damage. Eliminate the cause of the airborne water spray.

---

# Operation

EMU36381

## First-time operation

EMU36391

### Fill engine oil

The engine is shipped from the factory without engine oil. If your dealer did not fill the oil, you must fill it before starting the engine. **NOTICE: Check that the engine is filled with oil before first-time operation to avoid severe engine damage.** [ECM01781]

The engine is shipped with the following sticker, which should be removed after engine oil is filled for the first time. For more information on checking the engine oil level, see page 44.



ZMU01710

EMU30174

### Breaking in engine

Your new engine requires a period of break-in to allow mating surfaces of moving parts to wear in evenly. Correct break-in will help ensure proper performance and longer engine life. **NOTICE: Failure to follow the break-in procedure could result in reduced engine life or even severe engine damage.** [ECM00801]

EMU27085

### Procedure for 4-stroke models

Your new engine requires a period of 10 hours break-in to allow mating surfaces of moving parts to wear in evenly.

#### TIP:

Run the engine in the water, under load (in gear with a propeller installed) as follows. For 10 hours for breaking in engine avoid extended idling, rough water and crowded areas.

1. For the first hour of operation:  
Run the engine at varying speeds up to 2000 r/min or approximately half throttle.
2. For the second hour of operation:  
Increase engine speed as much as necessary to put the boat on plane (but avoid full-throttle operation), then back off on the throttle while keeping the boat at a planing speed.
3. Remaining 8 hours:  
Run the engine at any speed. However, avoid operating at full throttle for more than 5 minutes at a time.
4. After the first 10 hours:  
Operate the engine normally.

EMU36400

### Getting to know your boat

Different boats handle differently. Operate cautiously while you learn how your boat handles under different conditions and with different trim angles (see page 55).

EMU36412

### Checks before starting engine

EWMO1920



**If any item in the checks before starting engine is not working properly, have it inspected and repaired before operating the outboard motor. Otherwise an accident could occur.**

ECM00120

### NOTICE

**Do not start the engine out of water. Overheating and serious engine damage can occur.**

EMU36421

### Fuel level

Be sure you have plenty of fuel for your trip. A good rule is to use 1/3 of your fuel to get to the destination, 1/3 to return, and to keep 1/3 as an emergency reserve. With the boat level on



a trailer or in the water, turn the key to "ON" (on) and check the fuel level. For fuel filling instructions, see page 46.

EMU36431

## Remove cowling

For the following checks, remove the top cowling from the engine. To remove the engine cowling, release all the lock levers and lift off the cowling.

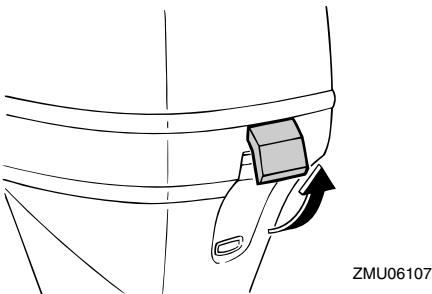
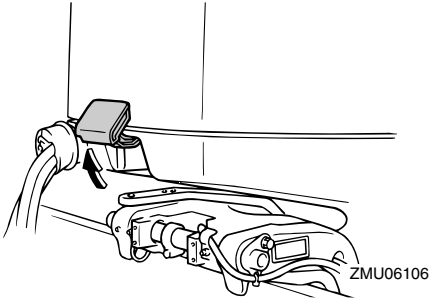

EMU36442

## Fuel system

EWM00060

### **WARNING**

**Gasoline and its vapors are highly flammable and explosive. Keep away from sparks, cigarettes, flames, or other sources of ignition.**

EWM00910

### **WARNING**

**Leaking fuel can result in fire or explosion.**

- Check for fuel leakage regularly.

- **If any fuel leakage is found, the fuel system must be repaired by a qualified mechanic. Improper repairs can make the outboard unsafe to operate.**

EMU36451

## Check for fuel leaks

- Check for fuel leaks or gasoline fumes in the boat.
- Check for fuel leakage from the fuel system.
- Check the fuel tank and fuel lines for cracks, swellings, or other damages.

EMU37320

## Check the fuel filter

Check that the fuel filter is clean and free of water. If any water is found in the fuel, or if a significant amount of debris is found, the fuel tank should be checked and cleaned by a Yamaha dealer.

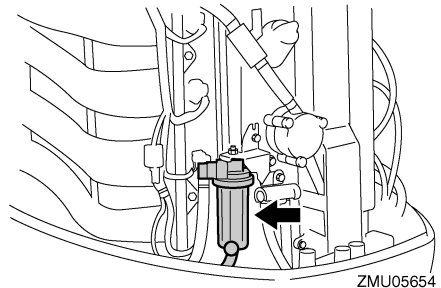

EMU36901

## Controls

Tiller handle models:

- Move the tiller handle fully to the left and right to make sure operation is smooth.
- Turn the throttle grip from the fully closed to the fully open position. Make sure that it turns smoothly and that it completely returns to the fully closed position.
- Look for loose or damaged connections of the throttle and shift cables.

Remote control models:

# Operation

- Turn the steering wheel full-right and full-left. Make sure operation is smooth and unrestricted throughout the whole range with no binding or excessive free play.
- Operate the throttle levers several times to make sure there is no hesitation in their travel. Operation should be smooth over the complete range of motion, and each lever should return completely to the idle position.
- Look for loose or damaged connections of the throttle and shift cables.

EMU36482

## Engine shut-off cord (lanyard)

Inspect the engine shut-off cord for damage, such as cuts, breaks, and wear.

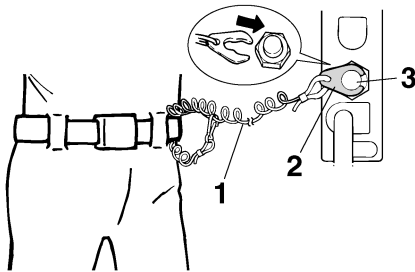

ZMU01716

1. Cord
2. Clip
3. Engine shut-off switch

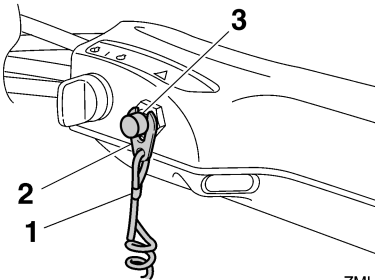

ZMU05208

1. Cord
2. Clip
3. Engine shut-off switch

EMU37052

## Engine oil

1. Put the outboard motor in an upright position (not tilted). **NOTICE: If the motor is not level, the oil level indicated on the dipstick may not be accurate.**

[ECM01790]

2. Remove oil dipstick and wipe it clean.
3. Insert the dipstick and remove it again. Be sure to completely insert the dipstick into the dipstick guide, otherwise the oil level measurement will be incorrect.
4. Check the oil level using the dipstick to be sure the level falls between the upper level mark and lower level mark. Consult your Yamaha dealer if the oil level is out of specified level or if it appears milky or dirty.

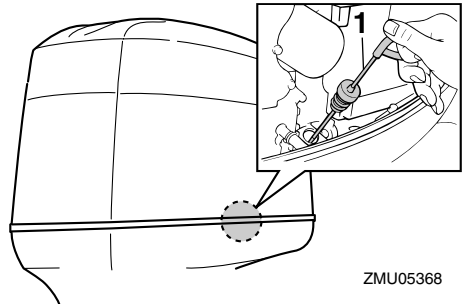

ZMU05368

1. Oil dipstick

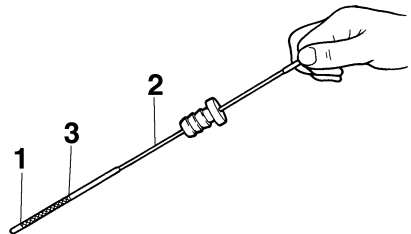

ZMU04815

1. Lower level mark
2. Oil dipstick
3. Upper level mark

EMU27153

## Engine

- Check the engine and engine mounting.
- Look for loose or damaged fasteners.
- Check the propeller for damage.
- Check for engine oil leaks.

EMU36490

## Flushing device

Check that flushing device's garden hose connector is securely screwed on to the fitting on the bottom cowling. **NOTICE: If the flushing device is not properly connected, cooling water can leak out and the engine can overheat during operation.** [ECM01800]

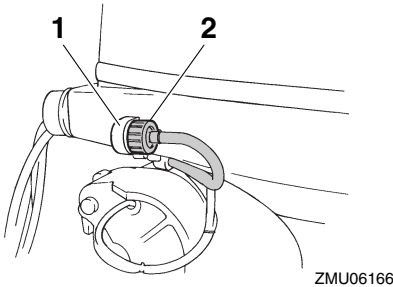

1. Fitting
2. Flushing device

EMU36962

## Install cowling

1. Be sure that all cowling lock levers are released.
2. Be sure that the rubber seal is seated all the way around the top cowling.
3. Place the top cowling on bottom cowling.
4. Check to be sure the rubber seal fits correctly all the way around the engine.
5. Move the levers to lock the cowling as shown. **NOTICE: If the cowling is not installed correctly, water spray under the cowling can damage the engine, or the cowling can blow off at high speeds.** [ECM01990]

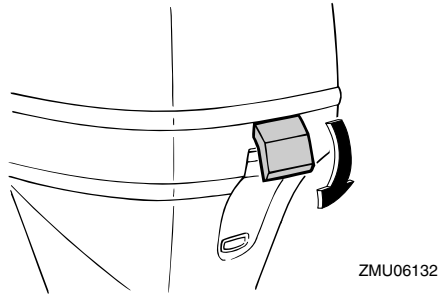
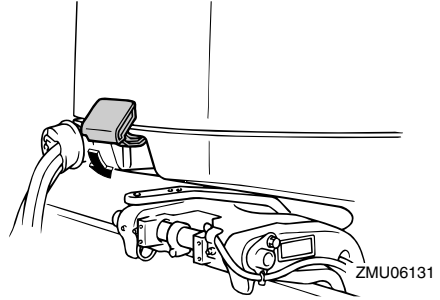

After installing, check the fitting of the top cowling by pushing it with both hands. If the top cowling is loose, have it repaired by your Yamaha dealer.

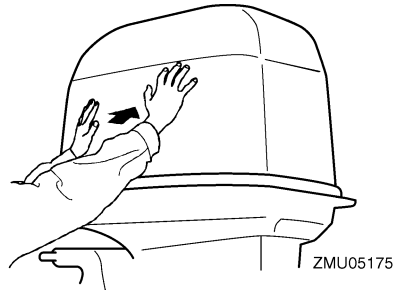

# Operation

EMU34581

## Power trim and tilt system

EWM01930

### WARNING

- **Never get under the lower unit while it is tilted, even when the tilt support lever is locked. Severe injury could occur if the outboard motor accidentally falls.**
- **Body parts can be crushed between the motor and the clamp bracket when the motor is trimmed or tilted.**
- **Be sure no one is near the outboard motor before performing this check.**

1. Check the power trim and tilt unit for any sign of oil leaks.
2. Operate each of the power trim and tilt switches to check that all switches work.
3. Tilt the outboard motor up and check that the trim and tilt rod is pushed out completely.

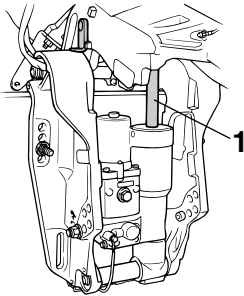

ZMU04244

1. Trim and tilt rod
4. Check that the trim and tilt rod is free of corrosion or other flaws.
5. Tilt the outboard motor down. Check that the trim and tilt rod operates smoothly.

EMU36582

## Battery

Check that the battery is in good condition, and fully charged. Check that the battery connections are clean, secure and covered by insulating covers. The electrical contacts of the

battery and cables must be clean and properly connected or the battery will not start the engine.

Refer to the battery manufacturer's instructions for checks for your particular battery.

EMU27437

## Filling fuel

EWM01830

### WARNING

- **Gasoline and its vapors are highly flammable and explosive. Always refuel according to this procedure to reduce the risk of fire and explosion.**
- **Gasoline is poisonous and can cause injury or death. Handle gasoline with care. Never siphon gasoline by mouth. If you should swallow some gasoline or inhale a lot of gasoline vapor, or get some gasoline in your eyes, see your doctor immediately. If gasoline spills on your skin, wash with soap and water. If gasoline spills on your clothing, change your clothes.**

1. Be sure the engine is stopped.
2. Disconnect the fuel line from the fuel tank and tighten the air vent screw on the fuel tank cap.

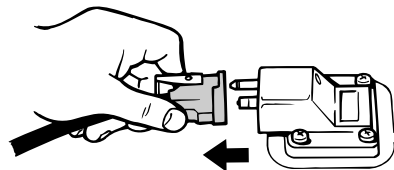

ZMU06598

3. Remove the portable tank from the boat.
4. Be sure you are in a well-ventilated outdoor area, either securely moored or trailered.

5. Do not smoke and keep away from sparks, flames, static electric discharge, or other sources of ignition.
6. If you use a portable container to store and dispense fuel, use only an approved GASOLINE container.
7. Touch the fuel nozzle to the filler opening or funnel to help prevent electrostatic sparks.
8. Fill the fuel tank, but do not overfill. Fuel can expand and overflow if the temperature increases.

Fuel tank capacity:  
25.0 L (6.61 US gal, 5.50 Imp.gal)

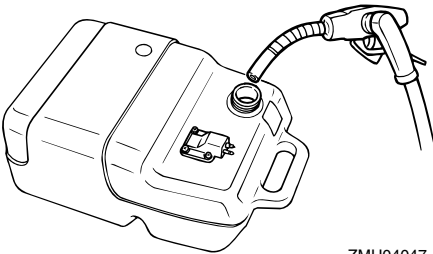

ZMU04047

9. Tighten the filler cap securely.
10. Wipe up any spilled gasoline immediately with dry rags. Dispose rags properly according to local laws or regulations.

EMU27451

## Operating engine

EMU27466

### Sending fuel (portable tank)

EWM00420

#### **WARNING**

- Before starting the engine, make sure that the boat is tightly moored and that you can steer clear of any obstructions. Be sure there are no swimmers in the water near you.

- When the air vent screw is loosened, gasoline vapor will be released. Gasoline is highly flammable, and its vapors are flammable and explosive. Refrain from smoking, and keep away from open flames and sparks while loosening the air vent screw.
- This product emits exhaust gases which contain carbon monoxide, a colorless, odorless gas which could cause brain damage or death when inhaled. Symptoms include nausea, dizziness, and drowsiness. Keep cockpit and cabin areas well ventilated. Avoid blocking exhaust outlets.

1. If there is an air vent screw on the fuel tank cap, loosen it 2 or 3 turns.

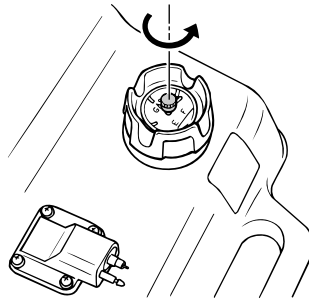

ZMU02022

2. If there is a fuel joint on the motor, firmly connect the fuel line to the joint. Then firmly connect the other end of the fuel line to the joint on the fuel tank.

# Operation

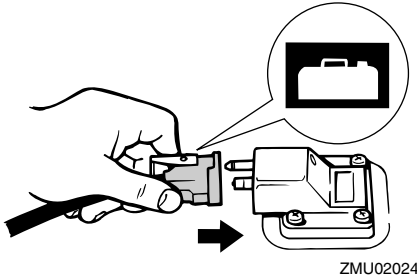

## TIP:

Wipe up any spilled gasoline immediately with dry rags. Dispose of rags properly according to local laws or regulations.

3. Squeeze the primer pump, with the arrow pointing up, until you feel it become firm. During engine operation place the tank horizontally, otherwise fuel cannot be drawn from the fuel tank.

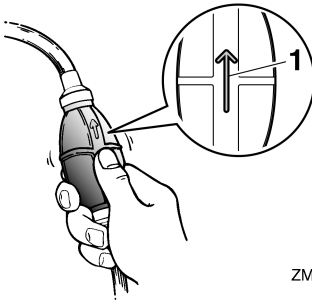

1. Arrow

EMU27493

## Starting engine

EWM01600

### WARNING

**Before starting the engine, make sure that the boat is tightly moored and that you can steer clear of any obstructions. Be sure there are no swimmers in the water near you.**

EMU38630

## Electric start / prime start models

EWM01840

### WARNING

- Failure to attached engine shut-off cord could result in a runaway boat if operator is ejected. Attach the engine shut-off cord to a secure place on your clothing, or your arm or leg while operating. Do not attach the cord to clothing that could tear loose. Do not route the cord where it could become entangled, preventing it from functioning.
- Avoid accidentally pulling the cord during normal operation. Loss of engine power means the loss of most steering control. Also, without engine power, the boat could slow rapidly. This could cause people and objects in the boat to be thrown forward.

1. If the lock mode of the Yamaha Security System is selected, use the remote control transmitter to select the unlock mode. Short beep will sound twice when unlocking the Yamaha Security System. For further information, see page 18.

## TIP:

- If you lost track of the current security mode, press the lock or unlock button to reset the security system.
  - The signal transmission range of the remote control transmitter varies depending on the mounting position of the receiver. To operate the Yamaha Security System correctly, use the transmitter as close as possible from the receiver.
  - If Yamaha Security System may not operate correctly, repeat the activating procedure once again.
2. Place the gear shift lever in neutral.

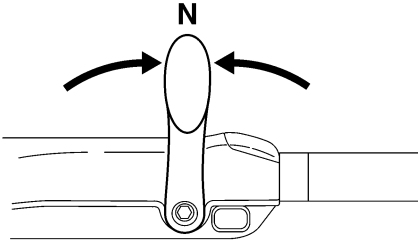

ZMU05215

## TIP:

The start-in-gear protection device prevents the engine from starting except when in neutral.

3. Attach the engine shut-off cord to a secure place on your clothing, or your arm or leg. Then install the clip on the other end of the cord into the engine shut-off switch.

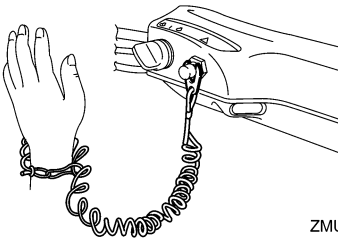

ZMU05216

4. Place the throttle grip in the “START” (start) position. After the engine starts, return the throttle to the fully closed position.

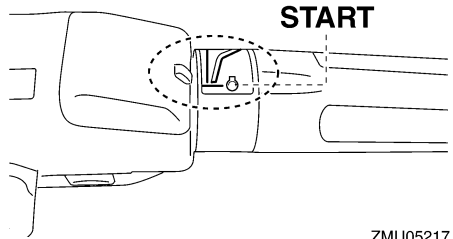

ZMU05217

5. Turn the main switch to “START” (start).

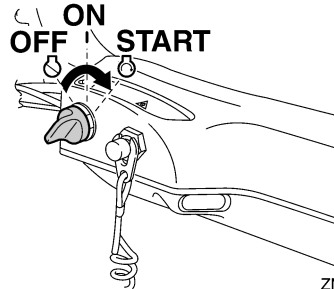

ZMU05218

6. Immediately after the engine starts, release the main switch and allow it to return to “ON” (on). **NOTICE: Never turn the main switch to “START” (start) while the engine is running. Do not keep the starter motor turning for more than 5 seconds. If the starter motor is turned continuously for more than 5 seconds, the battery will be quickly discharged, thus making it impossible to start the engine. The starter can also be damaged. If the engine will not start after 5 seconds of cranking, return the main switch to “ON” (on), wait 10 seconds, then crank the engine again.** [ECM00192]

## TIP:

- When the engine is cold, it needs to be warmed up. For further information, see page 51.

# Operation

- If the engine is warm and fails to start, open the throttle slightly and try to start the engine again. If the engine still fails to start, see page 84.

EMU38640

## Electric start and remote control models

EWM01840

### WARNING

- **Failure to attached engine shut-off cord could result in a runaway boat if operator is ejected. Attach the engine shut-off cord to a secure place on your clothing, or your arm or leg while operating. Do not attach the cord to clothing that could tear loose. Do not route the cord where it could become entangled, preventing it from functioning.**
- **Avoid accidentally pulling the cord during normal operation. Loss of engine power means the loss of most steering control. Also, without engine power, the boat could slow rapidly. This could cause people and objects in the boat to be thrown forward.**

1. If the lock mode of the Yamaha Security System is selected, use the remote control transmitter to select the unlock mode. Short beep will sound twice when unlocking the Yamaha Security System. For further information, see page 18.

### TIP:

- If you lost track of the current security mode, press the lock or unlock button to reset the security system.
- The signal transmission range of the remote control transmitter varies depending on the mounting position of the receiver. To operate the Yamaha Security System correctly, use the transmitter as close as possible from the receiver.

- If Yamaha Security System may not operate correctly, repeat the activating procedure once again.
2. Place the remote control lever in neutral.

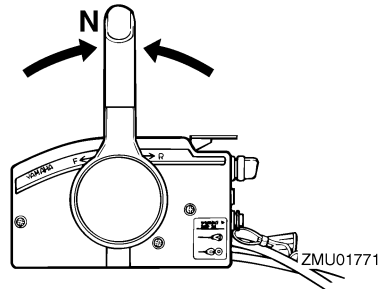

### TIP:

The start-in-gear protection device prevents the engine from starting except when in neutral.

3. Attach the engine shut-off cord to a secure place on your clothing, or your arm or leg. Then install the clip on the other end of the cord into the engine shut-off switch.

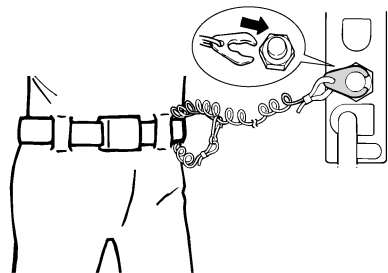

4. Turn the main switch to "ON" (on).
5. Turn the main switch to "START" (start).



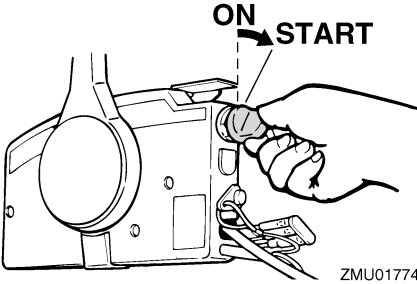

6. Immediately after the engine starts, release the main switch and allow it to return to “ON” (on). **NOTICE:** Never turn the main switch to “START” (start) while the engine is running. Do not keep the starter motor turning for more than 5 seconds. If the starter motor is turned continuously for more than 5 seconds, the battery will be quickly discharged, thus making it impossible to start the engine. The starter can also be damaged. If the engine will not start after 5 seconds of cranking, return the main switch to “ON” (on), wait 10 seconds, then crank the engine again. [ECM00192]

## TIP:

- When the engine is cold, it needs to be warmed up. For further information, see page 51.
- If the engine is warm and fails to start, open the throttle slightly and try to start the engine again. If the engine still fails to start, see page 84.

EMU36510

## Checks after starting engine

EMU36520

### Cooling water

Check for a steady flow of water from the cooling water pilot hole. A continuous flow of water from the pilot hole shows that the water pump is pumping water through the cooling passag-

es. If the cooling passages are frozen, it may take a while for water to start flowing out of the pilot hole.

ECM01810

## NOTICE

If water is not flowing out of the pilot hole at all times while the engine is running, overheating and serious damage could occur. Stop the engine and check whether the cooling water inlet on the lower case or the cooling water pilot hole is blocked. Consult your Yamaha dealer if the problem cannot be located and corrected.

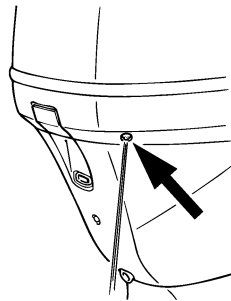

ZMU01775

Check that no water leaks from the joints between the exhaust cover, cylinder head, and body cylinder.

EMU27670

## Warming up engine

EMU30036

### Electric start models

1. After starting the engine, allow it to idle for 3 minutes to warm up to provide maximum operating performance and acceleration. Failure to do so will shorten engine life.
2. Be sure the low oil pressure-alert indicator remains off after starting the engine. **NOTICE:** If the low oil pressure-alert indicator blinks after the engine starts, stop the engine. Otherwise serious engine damage could occur. Check the oil level and add oil if necessary.

# Operation

Consult your Yamaha dealer if the cause for the low oil pressure-alert indicator cannot be found. [ECM01830]

EMU36530

## Checks after engine warm-up

EMU36540

### Shifting

While tightly moored, and without applying throttle, confirm that the engine shifts smoothly into forward and reverse, and back to neutral.

EMU36980

### Stop switches

- Turn the main switch to "OFF", or press the engine stop button and make sure the engine stops.
- Confirm that removing the clip from the engine shut-off switch stops the engine.
- Confirm that the engine cannot be started with the clip removed from the engine shut-off switch.

EMU34561

## Shifting

EWM00180

### **WARNING**

Before shifting, make sure there are no swimmers or obstacles in the water near you.

ECM01610

### **NOTICE**

Warm up the engine before shifting into gear. Until the engine is warm, the idle speed may be higher than normal. High idle speed can prevent you from shifting back to neutral. If this occurs, stop the engine, shift to neutral, then restart the engine and allow it to warm up.

#### To shift out of neutral

1. Pull the neutral interlock trigger up (if equipped).

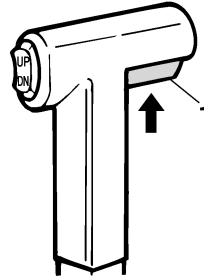

ZMU01727

1. Neutral interlock trigger
2. Move the remote control lever / gear shift lever firmly and crisply forward (for forward gear) or backward (for reverse gear) [about 35° (a detent can be felt) for remote control models]. Be sure to check that the tilt lock lever is in the lock/down position (if equipped) before operating in reverse.

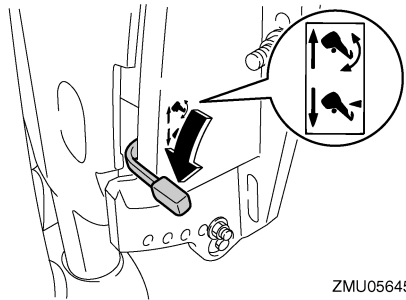

ZMU05645

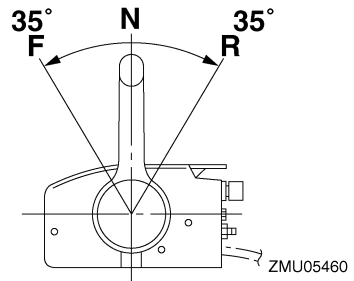

ZMU05460

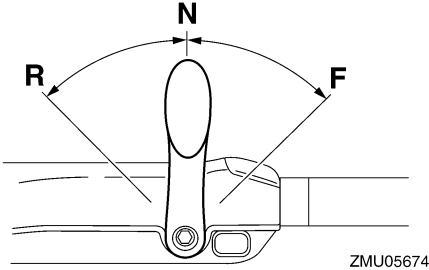

## TIP:

Tiller handle models: The gear shift lever operates only when the throttle grip is in the fully closed position.

To shift from in gear (forward/reverse) to neutral

1. Close the throttle so that the engine slows to idle speed.

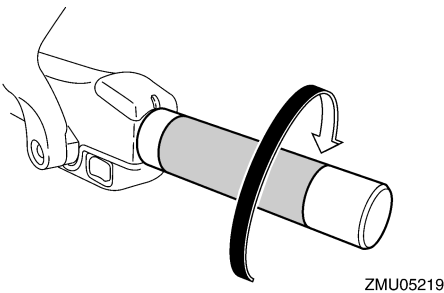
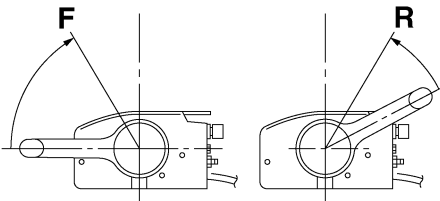

2. After the engine is at idle speed in gear move the remote control lever / gear shift lever firmly and crisply into the neutral position.

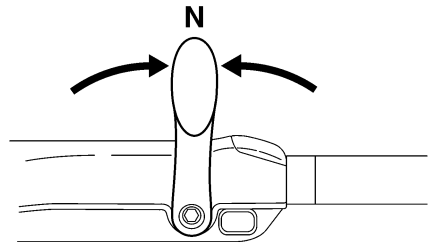
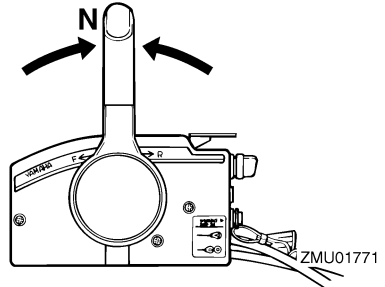

EMU31742

## Stopping boat

EWM01510

### **WARNING**

- Do not use the reverse function to slow down or stop the boat as it could cause you to lose control, be ejected, or impact the steering wheel or other parts of the boat. This could increase the risk of serious injury. It could also damage the shift mechanism.
- Do not shift into reverse while traveling at planing speeds. Loss of control, boat swamping, or damage to the boat could occur.

# Operation

The boat is not equipped with a separate braking system. Water resistance stops it after the throttle lever is moved back to idle. The stopping distance varies depending on gross weight, water surface conditions, and wind direction.

EMU30880

## Trolling

EMU30890

### Adjusting trolling speed

The trolling speed on outboard motors equipped with the variable trolling RPM switches can be adjusted approximately 50 r/min with each press of a switch.

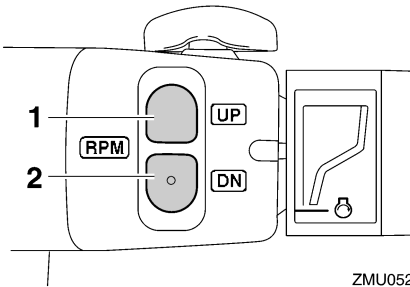

ZMU05222

1. "UP" switch
2. "DN" switch

To increase the trolling speed, press the "UP" switch.

To decrease the trolling speed, press the "DN" switch.

### TIP:

- The trolling speed changes approximately 50 r/min each time a switch is pressed.
- If the trolling speed has been adjusted, the engine returns to the normal trolling speed when the engine is stopped and restarted or when the engine speed exceeds approximately 3000 r/min.

EMU27821

## Stopping engine

Before stopping the engine, first let it cool off for a few minutes at idle or low speed. Stopping the engine immediately after operating at high speed is not recommended.

EMU38650

### Procedure

1. Push and hold the engine stop button or turn the main switch to "OFF" (off).

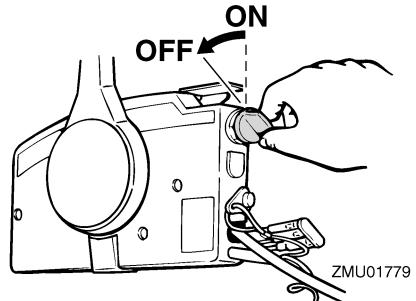

ZMU01779

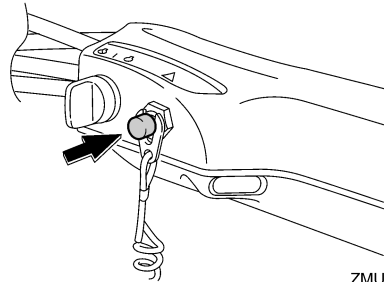

ZMU05209

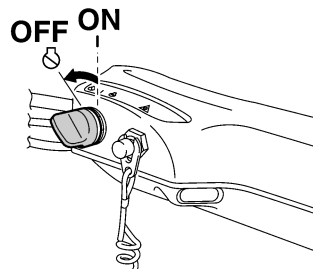

ZMU05223

2. After stopping the engine, disconnect the fuel line if there is a fuel joint on the outboard motor.
3. Tighten the air vent screw on the fuel tank cap (if equipped).

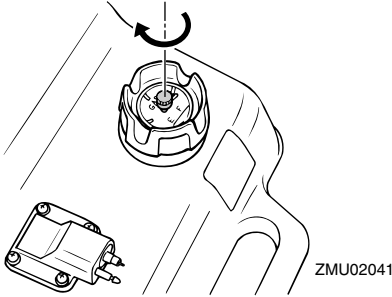

4. Remove the key if the boat will be left unattended.
5. When you leave your boat, set the Yamaha Security System to the lock mode by pressing the lock button of the remote control transmitter. Short beep will sound once when locking the security system. The lock mode is selected only when the main switch is in the "OFF" (off) position. For further information, see page 18. **WARNING! Do not set the Yamaha Security System in the lock mode when you stop the engine at offshore.** [EWM02150]

## TIP:

The engine can also be stopped by pulling the cord and removing the clip from the engine shut-off switch, then turning the main switch to "OFF" (off).

EMU27862

## Trimming outboard motor

EWM00740



**WARNING**

**Excessive trim for the operating conditions (either trim up or trim down) can cause boat instability and can make steer-**

**ing the boat more difficult. This increases the possibility of an accident. If the boat begins to feel unstable or is hard to steer, slow down and/or readjust the trim angle.**

The trim angle of the outboard motor helps determine the position of the bow of the boat in the water. Correct trim angle will help improve performance and fuel economy while reducing strain on the engine. Correct trim angle depends upon the combination of boat, engine, and propeller. Correct trim is also affected by variables such as the load in the boat, sea conditions, and running speed.

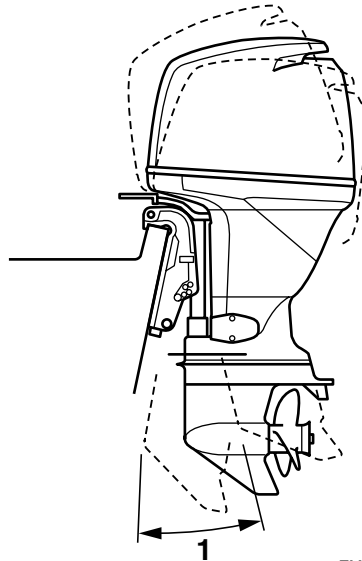

ZMU04258

1. Trim operating angle

# Operation

EMU27885

## Adjusting trim angle (Power trim and tilt)

EWM00753

### **WARNING**

- Be sure all people are clear of the outboard motor when adjusting the trim angle. Body parts can be crushed between the motor and the clamp bracket when the motor is trimmed or tilted.
- Use caution when trying a trim position for the first time. Increase speed gradually and watch for any signs of instability or control problems. Improper trim angle can cause loss of control.
- If equipped with a power trim and tilt switch located on the bottom cowling, use the switch only when the boat is at a complete stop with the engine off. Do not adjust the trim angle with this switch while the boat is moving.

Adjust the outboard motor trim angle using the power trim and tilt switch.

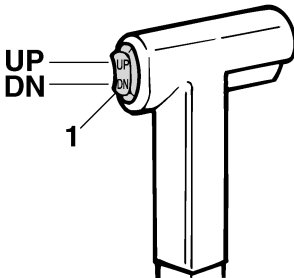

1. Power trim and tilt switch

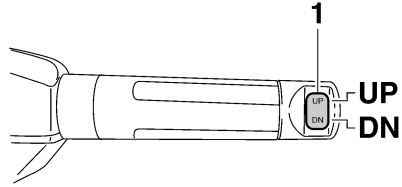

ZMU05224

1. Power trim and tilt switch

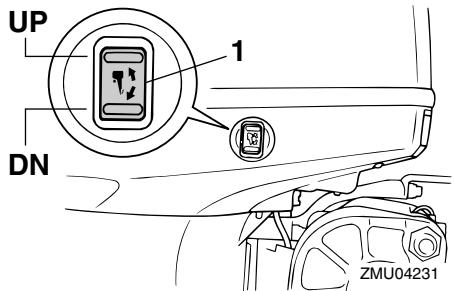

ZMU04231

1. Power trim and tilt switch

To raise the bow (trim-out), press the switch “UP” (up).

To lower the bow (trim-in), press the switch “DN” (down).

Make test runs with the trim set to different angles to find the position that works best for your boat and operating conditions.

EMU27892

## Adjusting trim angle for hydro tilt models

EWM00491

### **WARNING**

- Stop the engine before adjusting the trim angle.
- Be sure all people are clear of the outboard motor when adjusting the trim angle, also be careful not to pinch any body parts between the drive unit and clamp bracket.

- Use caution when trying a trim position for the first time. Increase speed gradually and watch for any signs of instability or control problems. Improper trim angle can cause loss of control.

1. Stop the engine.
2. Place the tilt lock lever in the release position.

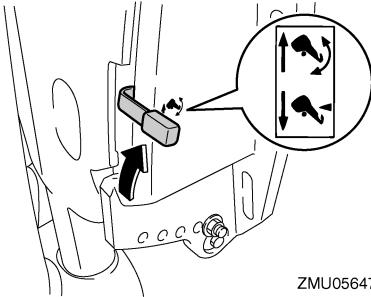

ZMU05647

3. Hold the rear of the top cowling with one hand and tilt the engine to the desired angle.
4. Place the tilt lock lever back into the lock position to support the engine.

To raise the bow (“trim-out”), tilt the engine up. To lower the bow (“trim-in”), tilt the engine down.

Make test runs with the trim set to different angles to find the position that works best for your boat and operating conditions.

EMU27912

## Adjusting boat trim

When the boat is on plane, a bow-up attitude results in less drag, greater stability and efficiency. This is generally when the keel line of the boat is up about 3 to 5 degrees. With the bow up, the boat may have a greater tendency to steer to one side or the other. Compensate for this as you steer. When the bow of the boat is down, it is easier to accelerate from a standing start onto plane.

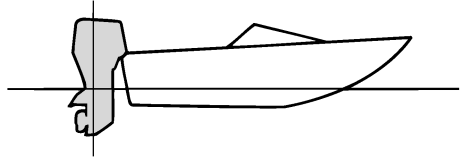

ZMU01784

## Bow Up

Too much trim-out puts the bow of the boat too high in the water. Performance and economy are decreased because the hull of the boat is pushing the water and there is more air drag. Excessive trim-out can also cause the propeller to ventilate, which reduces performance further, and the boat may “porpoise” (hop in the water), which could throw the operator and passengers overboard.

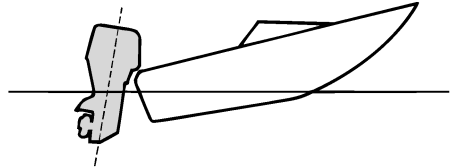

ZMU01785

## Bow Down

Too much trim-in causes the boat to “plow” through the water, decreasing fuel economy and making it hard to increase speed. Operating with excessive trim-in at higher speeds also makes the boat unstable. Resistance at the bow is greatly increased, heightening the danger of “bow steering” and making operation difficult and dangerous.

# Operation

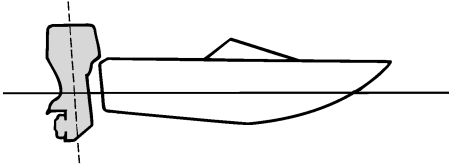

ZMU01786

## TIP:

Depending on the type of boat, the outboard motor trim angle may have little effect on the trim of the boat when operating.

EMU27934

## Tilting up and down

If the engine will be stopped for some time or if the boat is moored in shallows, the outboard motor should be tilted up to protect the propeller and lower casing from damage by collision with obstructions, and also to reduce salt corrosion.

EWM00221

## WARNING

Be sure all people are clear of the outboard motor when tilting up and down. Body parts can be crushed between the motor and the clamp bracket when the motor is trimmed or tilted.

EWM00250

## WARNING

Leaking fuel is a fire hazard. If there is a fuel joint on the outboard motor, disconnect the fuel line or close the fuel cock if the engine will be tilted for more than a few minutes. Otherwise fuel may leak.

ECM00241

## NOTICE

- Before tilting the outboard motor, stop the engine by following the procedure on page 54. Never tilt the outboard motor while the engine is running. Severe damage from overheating can result.
- Do not tilt up the engine by pushing the tiller handle (if equipped) because this could break the handle.

EMU27999

## Procedure for tilting up (hydro tilt models)

1. Place the remote control lever / gear shift lever in neutral.

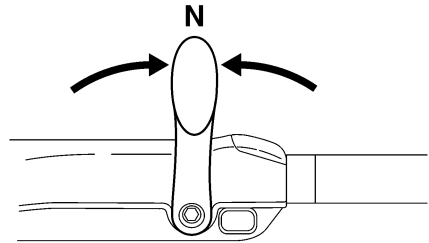

ZMU05215

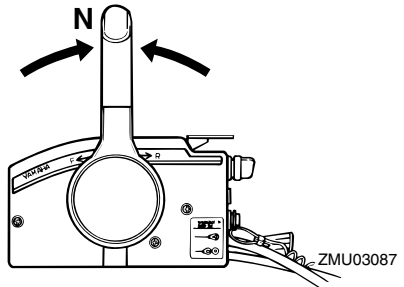

ZMU03087

2. Place the tilt lock lever in the release position.



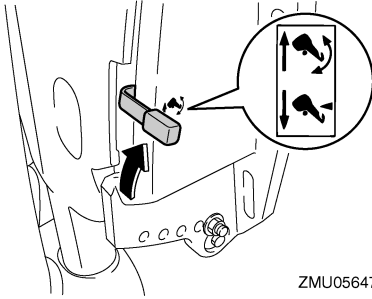

ZMU05647

3. Hold the rear of the top cowling with one hand, tilt the engine up, and turn the tilt support lever toward you or tilt support knob into the clamp bracket, and then place the tilt lock lever back into the lock position to support the outboard motor.  
**NOTICE: Do not use the tilt support lever or knob when trailering the boat. The outboard motor could shake loose from the tilt support and fall. If the motor cannot be trailered in the normal running position, use an additional support device to secure it in the tilt position. For more detailed information, see page 65.** [ECM01641]

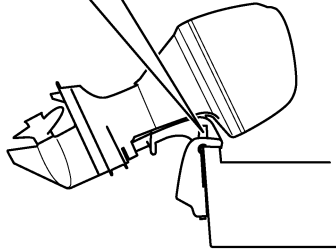
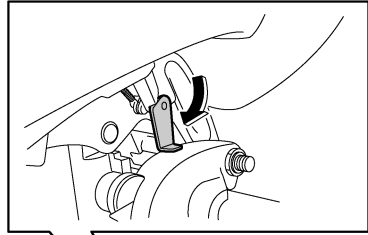

ZMU05652

EMU32724

## Procedure for tilting up (power trim and tilt models)

1. Place the remote control lever / gear shift lever in neutral.

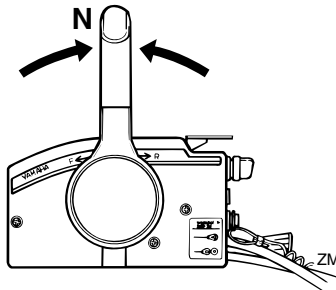

ZMU03196

# Operation

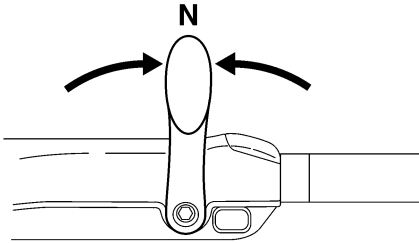

ZMU05215

2. Press the power trim and tilt switch “UP” (up) until the outboard motor has tilted up completely.

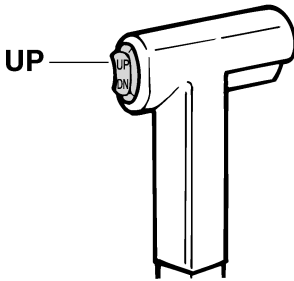

ZMU01787

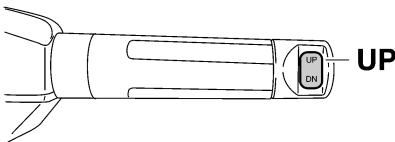

ZMU05226

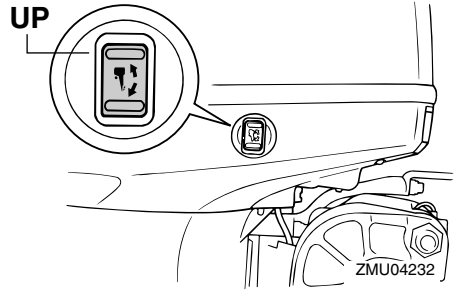

ZMU04232

3. Pull the tilt support lever toward you to support the engine. **WARNING!** After tilting the outboard motor, be sure to support it with the tilt support knob or tilt support lever. Otherwise the outboard motor could fall back down suddenly if oil in the power trim and tilt unit or in the power tilt unit loses pressure. [EWM00262] **NOTICE:** Do not use the tilt support lever or knob when trailering the boat. The outboard motor could shake loose from the tilt support and fall. If the motor cannot be trailered in the normal running position, use an additional support device to secure it in the tilt position. For more detailed information, see page 65.

[ECM01641]

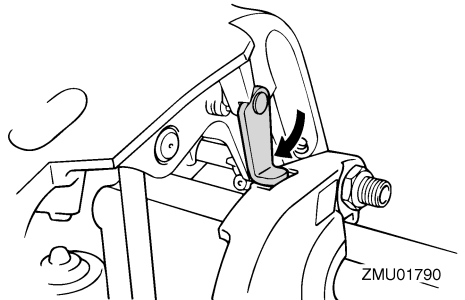

ZMU01790

4. Models equipped with trim rods: Once the outboard motor is supported with the tilt support lever, press the power trim and

tilt switch “DN” (down) to retract the trim rods. **NOTICE:** Be sure to retract the trim rods completely during mooring. This protects the rods from marine growth and corrosion which could damage the power trim and tilt mechanism. [ECM00251]

EMU34480

## Procedure for tilting down (hydro tilt models)

1. Release the tilt lock lever.

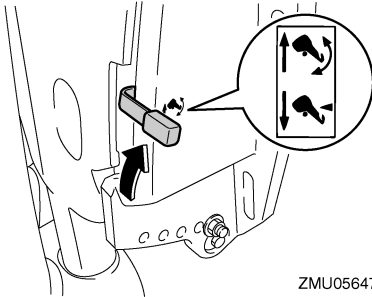

2. Hold the rear of the top cowling with one hand, tilt the outboard motor up slightly and pull out the tilt support knob or return the tilt support lever.

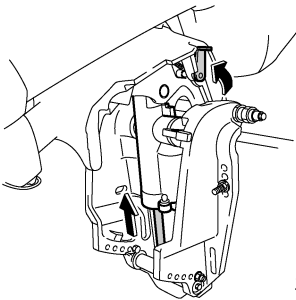

3. Slowly tilt the outboard motor down.
4. Place the tilt lock lever in the lock position.

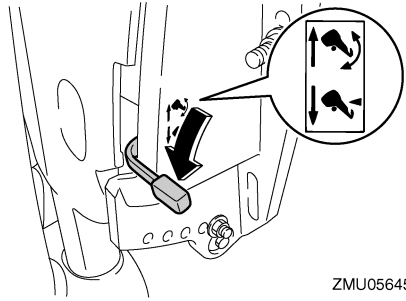

EMU33121

## Procedure for tilting down (power trim and tilt models)

1. Push the power trim and tilt switch “UP” (up) until the outboard motor is supported by the tilt rod and the tilt support lever becomes free.
2. Release the tilt support lever.

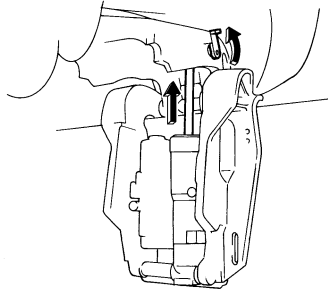

3. Push the power trim and tilt switch “DN” (down) to lower the outboard motor to the desired position.

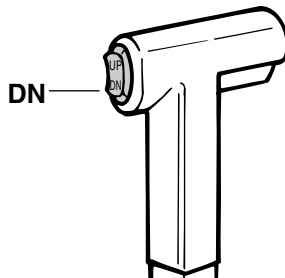

# Operation

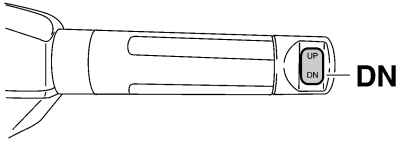

ZMU05228

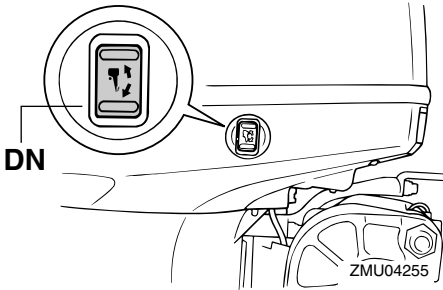

EMU28061

## Shallow water

EMU28081

### Hydro tilt models

The outboard motor can be tilted up partially to allow operation in shallow water.

EWM00271

### **WARNING**

- Run the boat at the lowest possible speed when using the shallow water cruising system.
- Use extra care when operating in reverse. Too much reverse thrust can cause the outboard motor to lift out of the water, increasing the chance of accident and personal injury.

ECM00260

### **NOTICE**

Do not tilt the outboard motor up so that the cooling water inlet on the lower unit is above the surface of the water when set-

ting up for and cruising in shallow water. Otherwise severe damage from overheating can result.

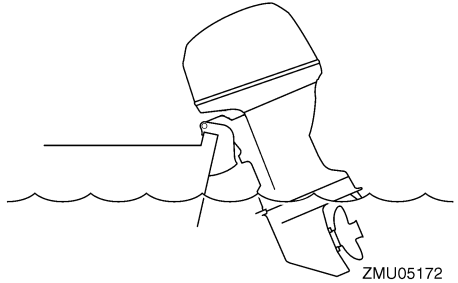

EMU28175

### Procedure for hydro tilt models

1. Place the remote control lever / gear shift lever in neutral.

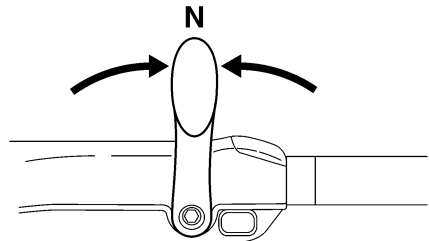
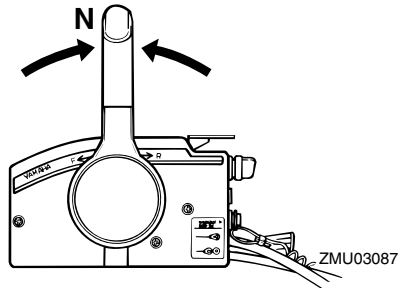

ZMU05215

2. Pull the tilt lock lever up to the release position.

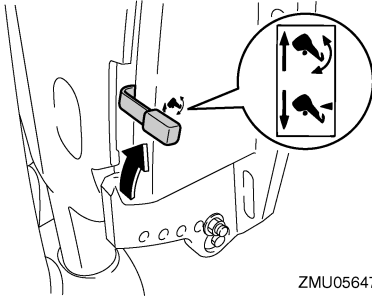

ZMU05647

3. Slightly tilt the outboard motor up to the desired position and push the tilt lock lever down to the lock position.
4. To return the outboard motor to the normal running position, pull the tilt lock lever up to the release position and slowly tilt the outboard motor down.
5. Push the tilt lock lever down to the lock position.

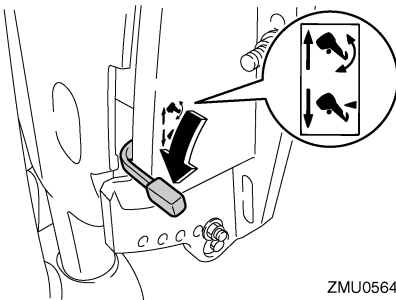

ZMU05645

EMU32851

## Power trim and tilt models

The outboard motor can be tilted up partially to allow operation in shallow water.

ECM00260

### **NOTICE**

**Do not tilt the outboard motor up so that the cooling water inlet on the lower unit is above the surface of the water when setting up for and cruising in shallow water. Otherwise severe damage from overheating can result.**

EMU32913

## Procedure for power trim and tilt models

1. Place the remote control lever / gear shift lever in neutral.

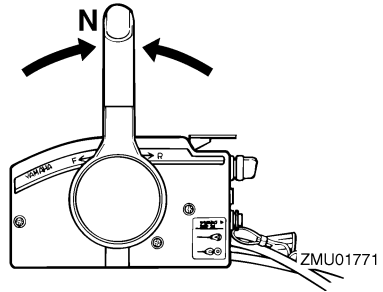

ZMU01771

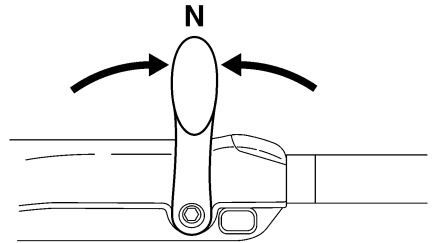

ZMU05215

2. Slightly tilt the outboard motor up to the desired position using the power trim and tilt switch. **WARNING! Using the power trim and tilt switch on the bottom cowling while the boat is moving or engine is on could increase the risk of falling overboard and could distract the operator, increasing the risk of collision with another boat or an obstacle.** [EWM01850]

# Operation

---

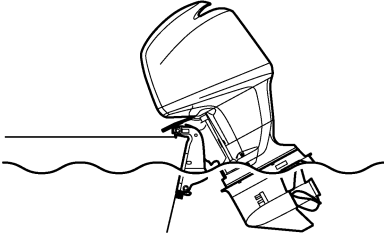

ZMU01793

3. To return the outboard motor to the normal running position, press the power trim and tilt switch and slowly tilt the outboard motor down.

EMU28195

## Cruising in other conditions

### Cruising in salt water

After operating in salt water, flush the cooling water passages with fresh water to prevent them from becoming clogged. Also rinse the outside of the outboard motor with fresh water.

### Cruising in muddy, turbid, or acidic water

Yamaha strongly recommends that you use the optional chromium-plated water pump kit (see page 13) if you use the outboard motor in acidic water or water with a lot of sediment in it, such as muddy or turbid (cloudy) water. After operating in such water, flush the cooling passages with fresh water to prevent corrosion. Also rinse the outside of the outboard motor with fresh water.

EMU28227

## Transporting and storing outboard motor

EWM00693

### **WARNING**

- **USE CARE** when transporting fuel tank, whether in a boat or car.
- **DO NOT** fill fuel container to maximum capacity. Gasoline will expand considerably as it warms up and can build up pressure in the fuel container. This can cause fuel leakage and a potential fire hazard.

EWM01860

### **WARNING**

Leaking fuel is a fire hazard. When transporting and storing the outboard motor, close the fuel cock to prevent fuel from leaking. Never get under the engine while it is tilted. Severe injury could occur if the outboard motor accidentally falls.

ECM00660

### **NOTICE**

Do not use the tilt support lever or knob when trailering the boat. The outboard motor could shake loose from the tilt support and fall. If the motor cannot be trailered in the normal running position, use an additional support device to secure it in the tilt position.

The outboard motor should be trailered and stored in the normal running position. If there is insufficient road clearance in this position, then trailer the outboard motor in the tilt position using a motor support device such as a transom saver bar. Consult your Yamaha dealer for further details.

EMU30041

## Storing outboard motor

When storing your Yamaha outboard motor for prolonged periods of time (2 months or longer), several important procedures must be performed to prevent excessive damage. It is advisable to have your outboard motor serviced by an authorized Yamaha dealer prior to storage. However, you, the owner, with a minimum of tools, can perform the following procedures.

ECM01350

### **NOTICE**

- To prevent problems which can be caused by oil entering the cylinder from the sump, keep the outboard motor in the attitude shown when transporting and storing it. Do not store or transport the outboard motor on its side (not upright).
- Do not place the outboard motor on its side before the cooling water has drained from it completely, otherwise water may enter the cylinder through the exhaust port and cause engine trouble.
- Store the outboard motor in a dry, well-ventilated place, not in direct sunlight.
- Drain the remaining gasoline from the vapor separator. Gasoline left in the vapor separator for a prolonged period of time will break down and could cause damage to the fuel line.

# Maintenance

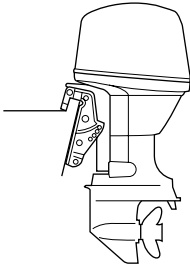

ZMU03659

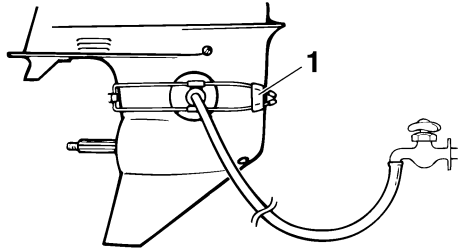

ZMU01830

EMU28304

## Procedure

EMU29955

### Flushing with the flushing attachment

1. Wash the outboard motor body using fresh water. **NOTICE: Do not spray water into the air intake.** [ECM01840] For further information, see page 68.
2. Disconnect the fuel line from the motor or shut off the fuel cock, if equipped.
3. Remove the top cowling and propeller.
4. Install the flushing attachment over the cooling water inlet. **NOTICE: Do not run the engine without supplying it with cooling water. Either the engine water pump will be damaged or the engine will be damaged from overheating. Before starting the engine, be sure to supply water to the cooling water passages. Avoid running the outboard motor at high speed while on the flushing attachment, otherwise overheating could occur.** [ECM02000]

### 1. Flushing attachment

5. Cooling system flushing is essential to prevent the cooling system from clogging up with salt, sand, or dirt. In addition, fogging/lubricating the engine is mandatory to prevent excessive engine damage due to rust. Perform the flushing and fogging at the same time. **WARNING! Do not touch or remove electrical parts when starting or during operation. Keep hands, hair, and clothes away from the flywheel and other rotating parts while the engine is running.** [EWM00091]

### TIP:

- When using the flushing attachment, maintain adequate water pressure and a steady water flow.
  - If the overheat alert device is activated, turn the engine off, and consult your Yamaha dealer.
6. Run the engine at a fast idle for a few minutes in neutral position.
  7. Just prior to turning off the engine, quickly spray "Fogging Oil" alternately into the intake silencer or the fogging hole of the silencer cover, if equipped. When properly done, the engine will smoke excessively and almost stall.
  8. Drain the remained gasoline in the vapor separator with a container. Loosen the drain screw, and then remove the cap.



Push in the air valve with a screwdriver to introduce air into the float chamber, so that the gasoline will drain smoothly. Then, tighten the drain screw.

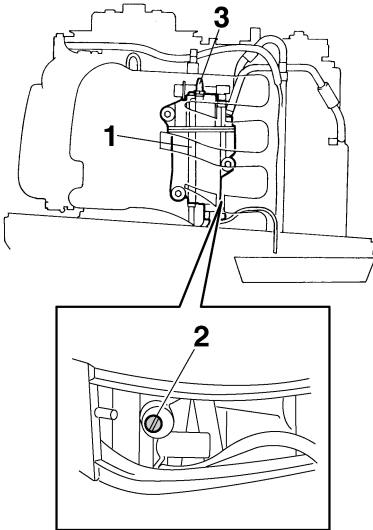

ZMU05656

1. Vapor separator
2. Drain screw
3. Cap

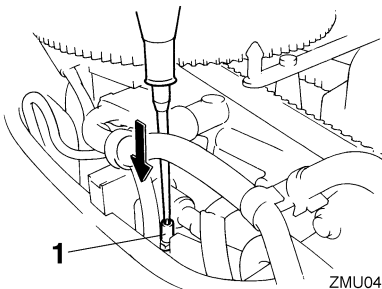

ZMU04818

1. Air valve
9. Remove the flushing attachment.
10. Install the top cowling.

11. If "Fogging Oil" is not available, turn off the engine after the 6 step. Then perform the 8 step procedure.
12. Drain the cooling water completely out of the motor. Clean the body thoroughly.
13. If the "Fogging Oil" is not available, remove the spark plug(s). Pour a teaspoonful of clean engine oil into each cylinder. Crank several times manually. Replace the spark plug(s).

## TIP:

A flushing attachment is available from your Yamaha dealer.

EMU28402

## Lubrication

1. Install the spark plug(s) and torque to proper specification. For information on spark plug installation, see page 75.
2. Change the gear oil. For instructions, see page 80. Inspect the oil for the presence of water that indicates a leaky seal. Seal replacement should be performed by an authorized Yamaha dealer prior to use.
3. Grease all grease fittings. For further details, see page 73.

## TIP:

For long-term storage, fogging the engine with oil is recommended. Contact your Yamaha dealer for information about fogging oil and procedures for your engine.

EMU28443

## Flushing power unit

Perform this procedure right after operation for the most thorough flushing.

ECM01530

## NOTICE

**Do not perform this procedure while the engine is running. The water pump may be damaged and severe damage from overheating can result.**

# Maintenance

1. After shutting off the engine, unscrew the garden hose connector from the fitting on the bottom cowling.

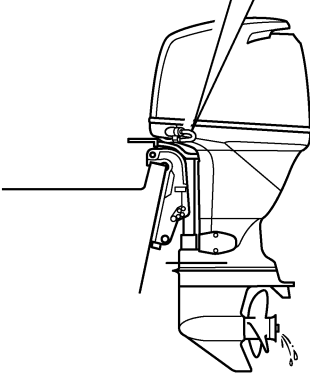
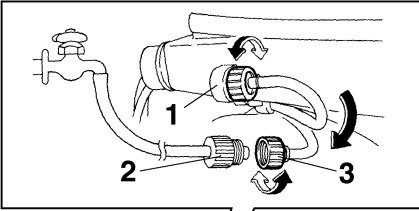

ZMU04819

1. Fitting
  2. Garden hose adapter
  3. Garden hose connector
2. Screw the garden hose adapter onto a garden hose, which is connected to a fresh water supply, and then connect it to the garden hose connector.
  3. With the engine off, turn on the water tap and let the water flush through the cooling passages for about 15 minutes. Turn off the water and disconnect the garden hose adapter from the garden hose connector.
  4. Reinstall the garden hose connector onto the fitting on the bottom cowling. Tighten the connector securely. **NOTICE: Do not leave the garden hose connector loose on the bottom cowling fitting or let the hose hang free during normal**

**operation. Water will leak out of the connector instead of cooling the engine, which can cause serious overheating. Be sure the connector is tightened securely on the fitting after flushing the engine.** [ECM00541]

## TIP:

- When flushing the engine with the boat in the water, tilting up the outboard motor until it is completely out of the water will achieve better results.
- For cooling system flushing instructions, see page 65.

EMU28451

## Cleaning the outboard motor

After use, wash the exterior of the outboard motor with fresh water. Flush the cooling system with fresh water.

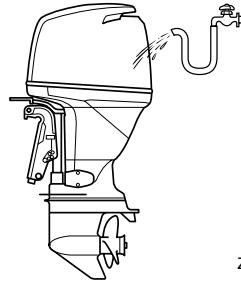

ZMU04265

EMU28460

## Checking painted surface of motor

Check the motor for scratches, nicks, or flaking paint. Areas with damaged paint are more likely to corrode. If necessary, clean and paint the areas. A touch-up paint is available from your Yamaha dealer.

EMU2847C

## Periodic maintenance

EWV01871



**WARNING**

**These procedures require mechanical skills, tools, and supplies. If you do not have the proper skills, tools, or supplies to**

**perform a maintenance procedure, have a Yamaha dealer or other qualified mechanic do the work.**

**The procedures involve disassembling the motor and exposing dangerous parts. To reduce the risk of injury from moving, hot, or electrical parts:**

- **Turn off the engine and keep the key(s) and engine shut-off cord (lanyard) with you when you perform maintenance unless otherwise specified.**
- **The power trim and tilt switches operate even when the ignition key is off. Keep people away from the switches whenever working around the motor. When the motor is tilted, keep away from the area under it or between it and the clamp bracket. Be sure no one is in this area before operating the power trim and tilt mechanism.**
- **Allow the engine to cool before handling hot parts or fluids.**
- **Always completely reassemble the motor before operation.**

- Operating continuously at a low engine speed (rpm) for many hours
- Operating without sufficient time for engine to warm up and cool down
- Frequent quick acceleration and deceleration
- Frequent shifting
- Frequently starting and stopping the engine(s)
- Operation that fluctuates often between light and heavy cargo loads

Outboard motors operating under any of these above conditions require more frequent maintenance. Yamaha recommends that you do this service twice as often as specified in the maintenance chart. For example, if a particular service should be done at 50 hours, do it instead at 25 hours. This will help prevent more rapid deterioration of engine components.

---

EMU28511

## **Replacement parts**

If replacement parts are necessary, use only genuine Yamaha parts or parts of equivalent design and quality. Any part of inferior quality may malfunction, and the resulting loss of control could endanger the operator and passengers. Yamaha genuine parts and accessories are available from your Yamaha dealer.

EMU34151

## **Severe operating conditions**

Severe operating conditions involve one or more of the following types of operation on a regular basis:

- Operating continuously at or near maximum engine speed (rpm) for many hours

# Maintenance

EMU34445

## Maintenance chart 1

### TIP:

- Refer to the sections in this chapter for explanations of each owner-specific action.
- The maintenance cycle on these charts assume usage of 100 hours per year and regular flushing of the cooling water passages. Maintenance frequency should be adjusted when operating the engine under adverse conditions such as extended trolling.
- Disassembly or repairs may be necessary depending on the outcome of maintenance checks.
- Expendable or consumable parts and lubricants will lose their effectiveness over time and through normal usage regardless of the warranty period.
- When operating in salt water, muddy, other turbid (cloudy), acidic water, the engine should be flushed with clean water after each use.

The “●” symbol indicates the check-ups which you may carry out yourself.

The “○” symbol indicates work to be carried out by your Yamaha dealer.

Item	Actions	Initial	Every			
		20 hours (3 months)	100 hours (1 year)	300 hours (3 years)	500 hours (5 years)	
Anode(s) (external)	Inspection or replacement as necessary		●/○			
Anode(s) (cylinder head, thermostat cover)	Inspection or replacement as necessary		○			
Anodes (exhaust cover, cooling water passage cover, Rectifier Regulator cover)	Replacement					○
Battery (electrolyte level, terminal)	Inspection	●/○	●/○			
Battery (electrolyte level, terminal)	Fill, charging or replacing as necessary		○			
Cooling water leakage	Inspection or replacement as necessary	○	○			
Cowling lock lever	Inspection		●/○			
Engine starting condition/noise	Inspection	●/○	●/○			
Engine idling speed/noise	Inspection	●/○	●/○			
Engine oil	Replacement	●/○	●/○			
Engine oil filter (cartridge)	Replacement		●/○			
Fuel filter (can be disassembled)	Inspection or replacement as necessary	●/○	●/○			

# Maintenance

Item	Actions	Initial	Every			
		20 hours (3 months)	100 hours (1 year)	300 hours (3 years)	500 hours (5 years)	
Fuel line(High pressure)	Inspection	●	●			
Fuel line(High pressure)	Inspection or replacement as necessary	○	○			
Fuel line(Low pressure)	Inspection	●	●			
Fuel line(Low pressure)	Inspection or replacement as necessary	○	○			
Fuel pump	Inspection or replacement as necessary			○		
Fuel/engine oil leakage	Inspection	○	○			
Gear oil	Replacement	●/○	●/○			
Greasing points	Greasing	●/○	●/○			
Impeller/water pump housing	Inspection or replacement as necessary		○			
Impeller/water pump housing	Replacement			○		
Power trim and tilt unit	Inspection	●/○	●/○			
Propeller/propeller nut/cotter pin	Inspection or replacement as necessary	●/○	●/○			
PCV (Pressure Control Valve)	Inspection or replacement as necessary		○			
Shift link/shift cable	Inspection, adjustment or replacement as necessary	○	○			
Spark plug(s)	Inspection or replacement as necessary		●/○			
Spark plug caps/spark plug wires	Inspection or replacement as necessary	○	○			
Water from the cooling water pilot hole	Inspection	●/○	●/○			
Throttle link/throttle cable/throttle pick-up timing	Inspection, adjustment or replacement as necessary	○	○			
Thermostat	Inspection or replacement as necessary		○			
Timing belt	Inspection or replacement as necessary		○			
Valve clearance	Inspection and adjustment				○	
Water inlet	Inspection	●/○	●/○			

# Maintenance

Item	Actions	Initial	Every			
		20 hours (3 months)	100 hours (1 year)	300 hours (3 years)	500 hours (5 years)	
Main switch/stop switch/choke switch	Inspection or replacement as necessary	○	○			
Wire harness connections/wire coupler connections	Inspection or replacement as necessary	○	○			
(Yamaha) Meter/gauge	Inspection	○	○			
(Yamaha) Fuel tank	Inspection and cleaning as necessary		○			

EMU34451

## Maintenance chart 2

Item	Actions	Every
		1000 hours
Exhaust guide/exhaust manifold	Inspection or replacement as necessary	○
Timing belt	Replacement	○

EMU28910

### TIP:

When using lead or high-sulfur gasoline, inspecting valve clearance may be required more frequently than every 500 hours.

EMU28941

## Greasing

Yamaha grease A (water resistant grease)

Yamaha grease D (corrosion resistant grease; for propeller shaft)

**F80BET, F100DET**

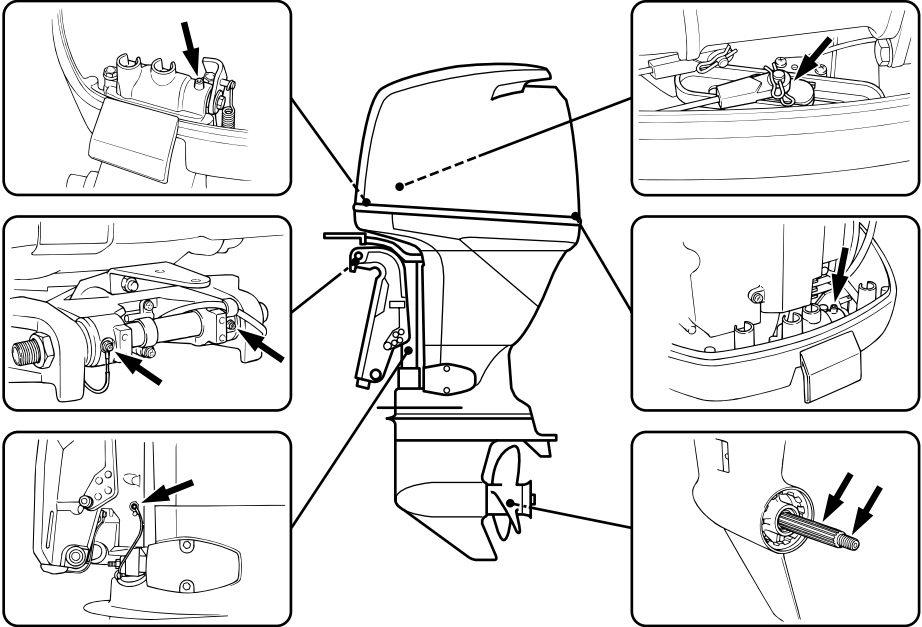

ZMU04266

# Maintenance

F80CED

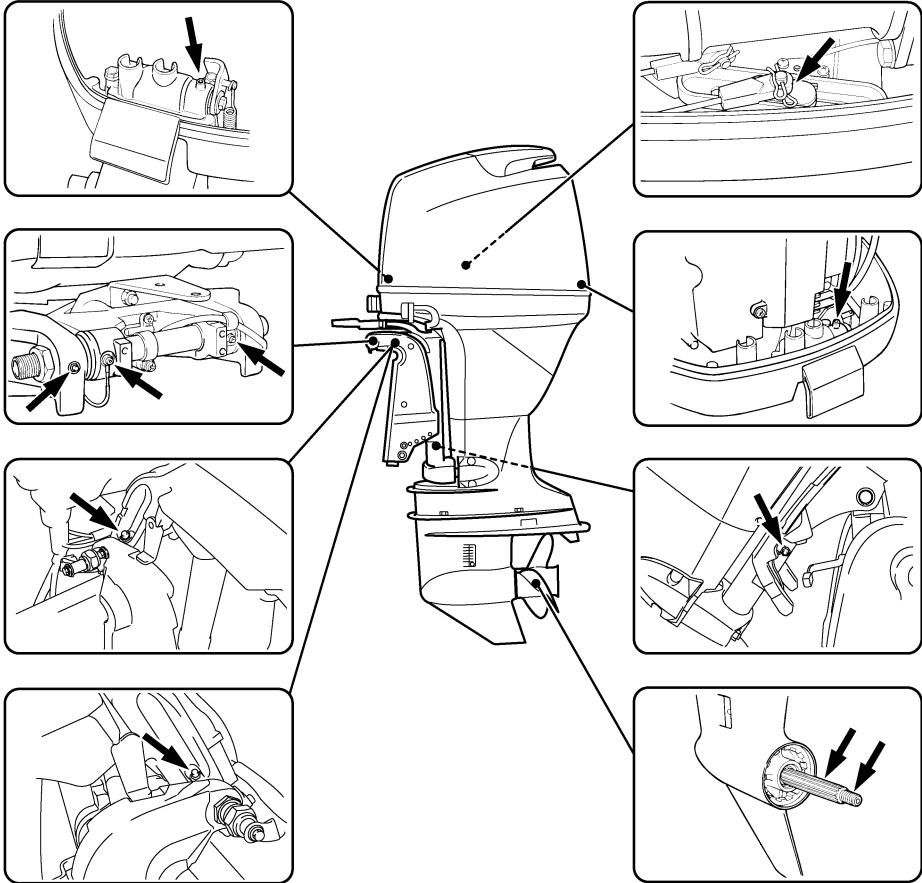

ZMU05650



EMU28956

## Cleaning and adjusting spark plug

The spark plug is an important engine component and is easy to inspect. The condition of the spark plug can indicate something about the condition of the engine. For example, if the center electrode porcelain is very white, this could indicate an intake air leak or carburetion problem in that cylinder. Do not attempt to diagnose any problems yourself. Instead, take the outboard motor to a Yamaha dealer. You should periodically remove and inspect the spark plug because heat and deposits will cause the spark plug to slowly break down and erode.

1. Remove the spark plug caps from the spark plugs.
2. Remove the spark plug. If electrode erosion becomes excessive, or if carbon and other deposits are excessive, you should replace the spark plug with another of the correct type. **WARNING! When removing or installing a spark plug, be careful not to damage the insulator. A damaged insulator could allow external sparks, which could lead to explosion or fire.** [EWM00561]

Standard spark plug:  
LFR5A-11

3. Be sure to use the specified spark plug, otherwise the engine may not operate properly. Before fitting the spark plug, measure the electrode gap with a wire thickness gauge; replace it if out of specification.

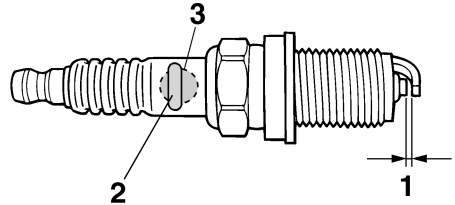

ZMU01797

1. Spark plug gap
2. Spark plug part number
3. Spark plug I.D. mark (NGK)

Spark plug gap:  
1.0–1.1 mm (0.039–0.043 in)

4. When fitting the plug, wipe off any dirt from the threads, and then screw it in to the correct torque.

Spark plug torque:  
25.0 Nm (2.55 kgf-m, 18.4 ft-lb)

### TIP:

If a torque-wrench is not available when you are fitting a spark plug, a good estimate of the correct torque is 1/4 to 1/2 a turn past finger-tight. Have the spark plug adjusted to the correct torque as soon as possible with a torque-wrench.

EMU29043

## Inspecting idling speed

EWM00451

### WARNING

- Do not touch or remove electrical parts when starting or during operation.
- Keep hands, hair, and clothes away from the flywheel and other rotating parts while the engine is running.

# Maintenance

ECM00490

## NOTICE

**This procedure must be performed while the outboard motor is in the water. A flushing attachment or test tank can be used.**

If the boat is not equipped with a tachometer for the outboard motor, use a diagnostic tachometer for this procedure. Results may vary depending on whether testing is conducted with the flushing attachment, in a test tank, or with the outboard motor in the water.

1. Start the engine and allow it to warm up fully in neutral until it is running smoothly.
2. Once the engine has warmed up, verify whether the idle speed is set to specification. For idle speed specifications, see page 9. If you have difficulty verifying the idle speed, or the idle speed requires adjustment, consult a Yamaha dealer or other qualified mechanic.

EMU37492

## Changing engine oil

ECM01710

## NOTICE

**Change the engine oil after the first 20 hours of operation or 3 months, and every 100 hours or at 1-year intervals thereafter. Otherwise the engine will wear quickly.**

The engine oil should be extracted with an oil changer.

1. Put the outboard motor in an upright position (not tilted). **NOTICE: If the motor is not level, the oil level indicated on the dipstick may not be accurate.**

[ECM01860]

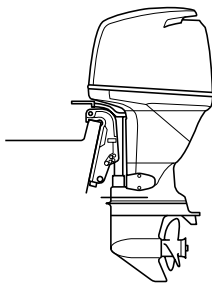

ZMU04270

2. Start the engine. Warm it up and keep the idle speed for 5-10 minutes.
3. Stop the engine and leave it for 5-10 minutes.
4. Remove the top cowling.
5. Remove the oil filler cap. Pull out the dipstick and use the oil changer to extract the oil completely.

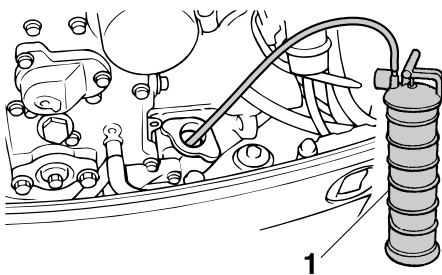

ZMU06195

1. Oil changer
6. Add the correct amount of oil through the filler hole. Put back the filler cap and the dipstick. **NOTICE: Overfilling the oil could cause leakage or damage. If the oil level is above the upper level mark, drain until the level meets the specified capacity.** [ECM01850]

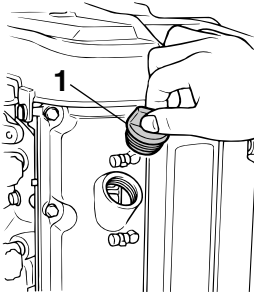

ZMU04271

1. Oil filler cap

## Recommended engine oil:

4-stroke outboard motor oil

Total engine oil quantity (oil pan capacity):

Without oil filter replacement:

4.3 L (4.55 US qt, 3.78 Imp.qt)

With oil filter replacement:

4.5 L (4.76 US qt, 3.96 Imp.qt)

Replacement engine oil quantity (at periodic maintenance):

Without oil filter replacement:

3.5 L (3.70 US qt, 3.08 Imp.qt)

With oil filter replacement:

3.7 L (3.91 US qt, 3.26 Imp.qt)

7. Leave the outboard motor for 5-10 minutes.
8. Remove oil dipstick and wipe it clean.
9. Insert the dipstick and remove it again. Be sure to completely insert the dipstick into the dipstick guide, otherwise the oil level measurement will be incorrect.
10. Recheck the oil level using the dipstick to be sure the level falls between the upper and lower marks. Consult your Yamaha dealer if the oil level is out of specified level.

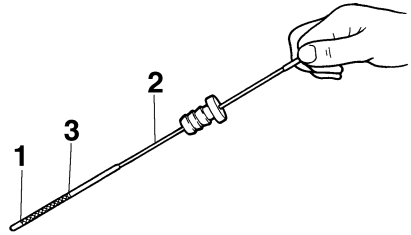

ZMU04815

1. Lower level mark
2. Oil dipstick
3. Upper level mark

11. Start the engine and make sure that the low oil pressure-alert indicator remains off. Also, make sure that there are no oil leaks. **NOTICE: If the low oil pressure-alert indicator comes on or if there are oil leaks, stop the engine and find the cause. Continued operation with a problem could cause severe engine damage. Consult your Yamaha dealer if the problem cannot be located and corrected.** [ECM01622]
12. Dispose of used oil according to local regulations.

## TIP:

- For more information on the disposal of used oil, consult your Yamaha dealer.
- Change the oil more often when operating the engine under adverse conditions such as extended trolling.

EMU29113

## Checking wiring and connectors

- Check that each connector is engaged securely.
- Check that each ground lead is properly secured.

# Maintenance

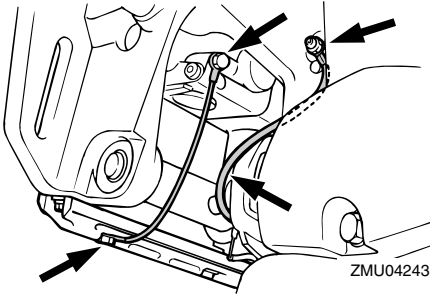

and remove the clip from the engine shut-off switch. Turn off the battery cut-off switch if your boat has one.

Do not use your hand to hold the propeller when loosening or tightening the propeller nut. Put a wood block between the anti-cavitation plate and the propeller to prevent the propeller from turning.

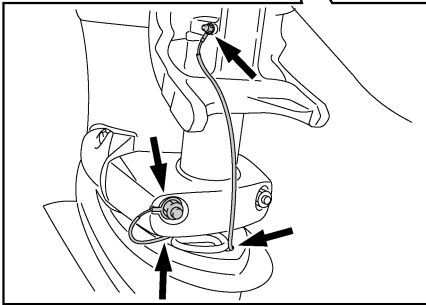
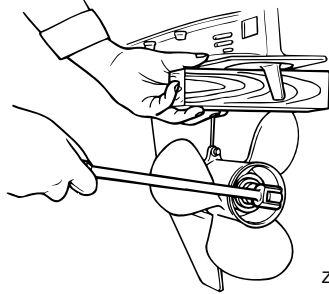
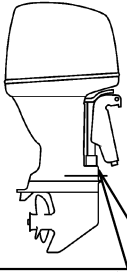

## Checkpoints

- Check each of the propeller blades for erosion from cavitation or ventilation, or other damage.
- Check the propeller shaft for damage.
- Check the splines for wear or damage.
- Check for fish line tangled around the propeller shaft.

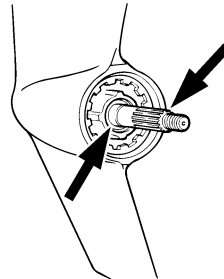

EMU32112

## Checking propeller

EWM01881



You could be seriously injured if the engine accidentally starts when you are near the propeller. Before inspecting, removing, or installing the propeller, place the shift control in neutral, turn the main switch to "OFF" (off) and remove the key,

- Check the propeller shaft oil seal for damage.

EMU30662

## Removing propeller

EMU29197

### Spline models

1. Straighten the cotter pin and pull it out using a pair of pliers.
2. Remove the propeller nut, washer, and spacer (if equipped). **WARNING! Do not use your hand to hold the propeller when loosening the propeller nut.**

[EWM01890]

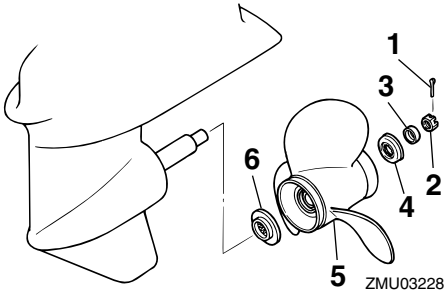

1. Cotter pin
  2. Propeller nut
  3. Washer
  4. Spacer
  5. Propeller
  6. Thrust washer
3. Remove the propeller, washer (if equipped), and thrust washer.

EMU30672

## Installing propeller

EMU29233

### Spline models

ECM00500

### **NOTICE**

**Be sure to use a new cotter pin and bend the ends over securely. Otherwise the propeller could come off during operation and be lost.**

1. Apply Yamaha marine grease or a corrosion resistant grease to the propeller shaft.

2. Install the spacer (if equipped), thrust washer, washer (if equipped), and propeller on the propeller shaft. **NOTICE: Be sure to install the thrust washer before installing the propeller, otherwise the lower case and propeller boss could be damaged.** [ECM01880]
3. Install the spacer (if equipped) and the washer. Tighten the propeller nut to the specified torque.

Propeller nut tightening torque:  
F100DET 35.0 Nm (3.57 kgf-m,  
25.8 ft-lb)  
F80BET 35.0 Nm (3.57 kgf-m,  
25.8 ft-lb)  
F80CED 55.0 Nm (5.61 kgf-m,  
40.6 ft-lb)

4. Align the propeller nut with the propeller shaft hole. Insert a new cotter pin in the hole and bend the cotter pin ends. **NOTICE: Do not reuse the cotter pin installed. Otherwise the propeller can come off during operation.** [ECM01890]

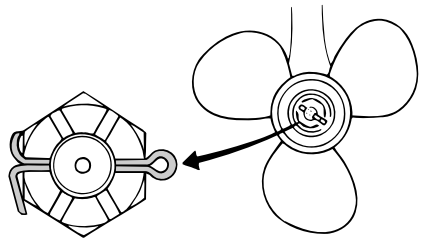

ZMU02063

### **TIP:**

If the propeller nut does not align with the propeller shaft hole after tightening to the specified torque, tighten the nut further to align it with the hole.

# Maintenance

EMU29287

## Changing gear oil

EWMM00800

### WARNING

- Be sure the outboard motor is securely fastened to the transom or a stable stand. You could be severely injured if the outboard motor falls on you.
- Never get under the lower unit while it is tilted, even when the tilt support lever or knob is locked. Severe injury could occur if the outboard motor accidentally falls.

1. Tilt the outboard motor so that the gear oil drain screw is at the lowest point possible.
2. Place a suitable container under the gear case.
3. Remove the gear oil drain screw and gasket. **NOTICE: If there is an excessive quantity of metal particles on the magnetic gear oil drain screw, this can indicate lower unit problem. Consult your Yamaha dealer.** [ECM01900]

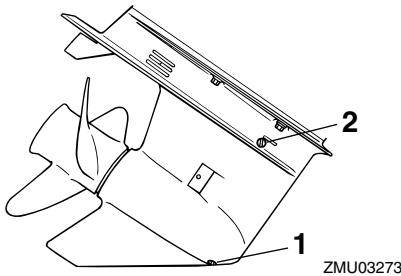

1. Gear oil drain screw
2. Oil level plug

### TIP:

- If a magnetic gear oil drain screw is equipped, remove all metal particles from the screw before installing it.

- Always use new gaskets. Do not reuse the removed gaskets.
4. Remove the oil level plug and gasket to allow the oil to drain completely. **NOTICE: Inspect the used oil after it has been drained. If the oil is milky, water is getting into the gear case which can cause gear damage. Consult a Yamaha dealer for repair of the lower unit seals.** [ECM00711]

### TIP:

For disposal of used oil, consult your Yamaha dealer.

5. Put the outboard motor in a vertical position. Using a flexible or pressurized filling device, inject the gear oil into the gear oil drain screw hole.

Recommended gear oil:  
Hypoid gear oil SAE#90  
Gear oil quantity:  
F100DET 0.670 L (0.708 US qt,  
0.590 Imp.qt)  
F80BET 0.670 L (0.708 US qt,  
0.590 Imp.qt)  
F80CED 0.760 L (0.803 US qt,  
0.669 Imp.qt)

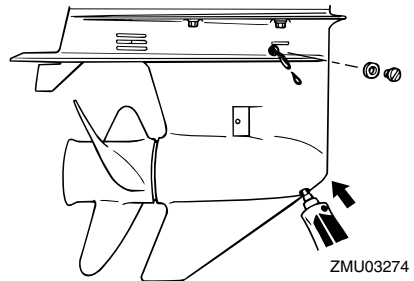

6. Put a new gasket on the oil level plug. When the oil begins to flow out of the oil level plug hole, insert and tighten the oil level plug.

Tightening torque:  
9.0 Nm (0.92 kgf-m, 6.6 ft-lb)

- Put a new gasket on the gear oil drain screw. Insert and tighten the gear oil drain screw.

Tightening torque:  
9.0 Nm (0.92 kgf-m, 6.6 ft-lb)

EMU29302

## Cleaning fuel tank

EWM00920

### **WARNING**

Gasoline is highly flammable, and its vapors are flammable and explosive.

- If you have any question about properly doing this procedure, consult your Yamaha dealer.
- Keep away from sparks, cigarettes, flames, or other sources of ignition when cleaning the fuel tank.
- Remove the fuel tank from the boat before cleaning it. Work only outdoors in an area with good ventilation.
- Wipe up any spilled fuel immediately.
- Reassemble the fuel tank carefully. Improper assembly can result in a fuel leak, which could result in a fire or explosion hazard.
- Dispose of old gasoline according to local regulations.

- Empty the fuel tank into an approved container.
- Pour a small amount of suitable solvent into the tank. Install the cap and shake the tank. Drain the solvent completely.

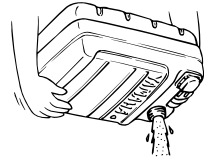
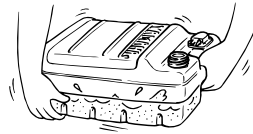
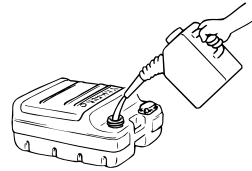

ZMU03231

- Remove the screws holding the fuel joint assembly. Pull the assembly out of the tank.

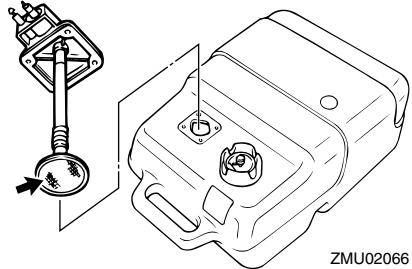

ZMU02066

- Clean the filter (located on the end of the suction pipe) in a suitable cleaning solvent. Allow the filter to dry.
- Replace the gasket with a new one. Reinstall the fuel joint assembly and tighten the screws firmly.

# Maintenance

EMU29313

## Inspecting and replacing anode(s)

Yamaha outboard motors are protected from corrosion by sacrificial anodes. Inspect the external anodes periodically. Remove scales from the surfaces of the anodes. Consult a Yamaha dealer for replacement of external anodes.

ECM00720

### **NOTICE**

**Do not paint anodes, as this would render them ineffective.**

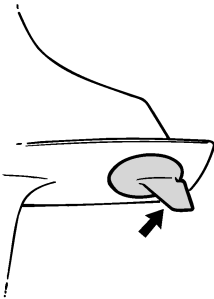

ZMU01808

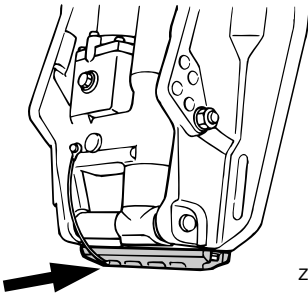

ZMU04245

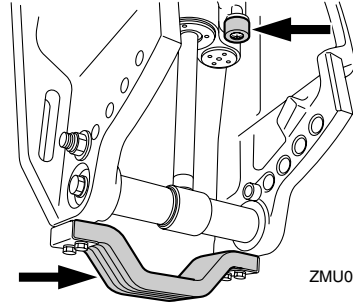

ZMU06320

### **TIP:**

Inspect ground leads attached to external anodes on equipped models. Consult a Yamaha dealer for inspection and replacement of internal anodes attached to the power unit.

EMU29322

## Checking battery (for electric start models)

EWM01900

### **WARNING**

**Battery electrolytic fluid is poisonous and caustic, and batteries generate explosive hydrogen gas. When working near the battery:**

- Wear protective eye gear and rubber gloves.
- Do not smoke or bring any other source of ignition near the battery.

**Refer to page 11 for detailed safety information about batteries.**

The procedure for checking the battery varies for different batteries. This procedure contains typical checks that apply to many batteries, but you should always refer to the battery manufacturer's instructions.

ECM01920

### **NOTICE**

**A poorly maintained battery will quickly deteriorate.**

1. Check the electrolyte level.



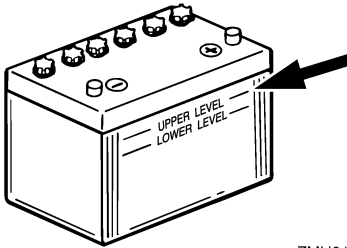

ZMU01810

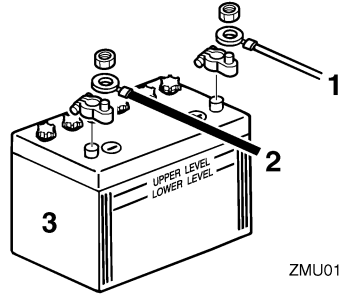

ZMU01811

2. Check the battery's charge. If your boat is equipped with the digital speedometer, the voltmeter and low battery alert functions will help you monitor the battery's charge. If the battery needs charging, consult your Yamaha dealer.
3. Check the battery connections. They should be clean, secure, and covered by an insulating cover. **WARNING! Bad connections can produce shorting or arcing and cause an explosion.** [EWM01910]

EMU29333

## Connecting the battery

EWM00570



### WARNING

Mount the battery holder securely in a dry, well-ventilated, vibration-free location in the boat. Install a fully charged battery in the holder.

ECM01123

### NOTICE

Reversal of the battery cables will damage the electrical parts.

1. Make sure the main switch (on applicable models) is "OFF" (off) before working on the battery.
2. Connect the red battery cable to the POSITIVE (+) terminal first. Then connect the black battery cable to the NEGATIVE (-) terminal.

1. Red cable
2. Black cable
3. Battery

3. The electrical contacts of the battery and cables must be clean and properly connected, or the battery will not start the engine.

EMU29371

## Disconnecting the battery

1. Turn off the battery cut-off switch (if equipped) and main switch. **NOTICE: If they are left on, the electrical system can be damaged.** [ECM01930]
2. Disconnect the negative cable(s) from the negative (-) terminal. **NOTICE: Always disconnect all negative (-) cables first to avoid a short circuit and damage to the electrical system.**

[ECM01940]

3. Disconnect the positive cable(s) and remove the battery from the boat.
4. Clean, maintain, and store the battery according to the manufacturer's instructions.

EMU38660

## Storing the battery

When storing your Yamaha outboard motor for prolonged periods of time (2 months or longer), remove the battery and store it in a cool, dry place.

Check the battery and charge it if necessary.

# Trouble Recovery

---

EMU38671

## Troubleshooting

A problem in the fuel, compression, or ignition systems can cause poor starting, loss of power, or other problems. This section describes basic checks and possible remedies, and covers all Yamaha outboard motors. Therefore some items may not apply to your model.

If your outboard motor requires repair, bring it to your Yamaha dealer.

If the engine trouble-alert indicator is flashing, consult your Yamaha dealer.

### **The Yamaha Security System does not operate correctly.**

Q. Is receiver within the communicating range from the remote control transmitter?

A. Operate remote control transmitter within the communicating range from the receiver.

Q. Is main switch “ON” position?

A. Turn main switch to “OFF” position.

Q. Is communication obstructing objects such as other source of communication machine or metal close by?

A. Operate remote control transmitter away from the other source of communication machine or metal.

Q. Is remote control transmitter registered?

A. Use remote control transmitter registered with the receiver.

Q. Has the battery cell of the remote control transmitter discharged?

A. Operate from spare remote control transmitter or replace battery cell by a Yamaha dealer.

Q. Are battery connections loose or corroded?

A. Tighten battery cables and clean battery terminals.

Q. Is battery capacity weak or low?

A. Check battery condition. Use battery of recommended capacity.

### **Starter will not operate.**

Q. Is battery capacity weak or low?

A. Check battery condition. Use battery of recommended capacity.

Q. Are battery connections loose or corroded?

A. Tighten battery cables and clean battery terminals.

Q. Is fuse for electric start relay or electric circuit blown?

A. Check for cause of electric overload and repair. Replace fuse with one of correct amperage.

Q. Are starter components faulty?

A. Have serviced by a Yamaha dealer.

Q. Is shift lever in gear?

A. Shift to neutral.

### **Engine will not start (starter operates).**

Q. Is your Yamaha Security System in the lock mode?

A. Set the security system to the unlock mode. For further information, see page 18.

Q. Is fuel tank empty?

A. Fill tank with clean, fresh fuel.

Q. Is fuel contaminated or stale?

A. Fill tank with clean, fresh fuel.

# Trouble Recovery

---

Q. Is fuel filter clogged?

A. Clean or replace filter.

Q. Is starting procedure incorrect?

A. See page 48.

Q. Has fuel pump malfunctioned?

A. Have serviced by a Yamaha dealer.

Q. Are spark plug(s) fouled or of incorrect type?

A. Inspect spark plug(s). Clean or replace with recommended type.

Q. Are spark plug cap(s) fitted incorrectly?

A. Check and re-fit cap(s).

Q. Is ignition wiring damaged or poorly connected?

A. Check wires for wear or breaks. Tighten all loose connections. Replace worn or broken wires.

Q. Are ignition parts faulty?

A. Have serviced by a Yamaha dealer.

Q. Is engine shut-off cord (lanyard) not attached?

A. Attach cord.

Q. Are engine inner parts damaged?

A. Have serviced by a Yamaha dealer.

## **Engine idles irregularly or stalls.**

Q. Are spark plug(s) fouled or of incorrect type?

A. Inspect spark plug(s). Clean or replace with recommended type.

Q. Is fuel system obstructed?

A. Check for pinched or kinked fuel line or other obstructions in fuel system.

Q. Is fuel contaminated or stale?

A. Fill tank with clean, fresh fuel.

Q. Is fuel filter clogged?

A. Clean or replace filter.

Q. Have ignition parts failed?

A. Have serviced by a Yamaha dealer.

Q. Has alert system activated?

A. Find and correct cause of alert.

Q. Is spark plug gap incorrect?

A. Inspect and adjust as specified.

Q. Is ignition wiring damaged or poorly connected?

A. Check wires for wear or breaks. Tighten all loose connections. Replace worn or broken wires.

Q. Is specified engine oil not being used?

A. Check and replace oil as specified.

Q. Is thermostat faulty or clogged?

A. Have serviced by a Yamaha dealer.

Q. Is fuel pump damaged?

A. Have serviced by a Yamaha dealer.

Q. Is air vent screw on fuel tank closed?

A. Open air vent screw.

Q. Is motor angle too high?

A. Return to normal operating position.

Q. Is fuel joint connection incorrect?

# Trouble Recovery

---

A. Connect correctly.

Q. Is throttle valve adjustment incorrect?

A. Have serviced by a Yamaha dealer.

Q. Is battery cable disconnected?

A. Connect securely.

## **Alert buzzer sounds or indicator lights.**

Q. Is cooling system clogged?

A. Check water intake for restriction.

Q. Is engine oil level low?

A. Fill oil tank with specified engine oil.

Q. Is heat range of spark plug incorrect?

A. Inspect spark plug and replace it with recommended type.

Q. Is specified engine oil not being used?

A. Check and replace oil with specified type.

Q. Is engine oil contaminated or deteriorated?

A. Replace oil with fresh, specified type.

Q. Is oil filter clogged?

A. Have serviced by a Yamaha dealer.

Q. Is load on boat improperly distributed?

A. Distribute load to place boat on an even plane.

Q. Is water pump or thermostat faulty?

A. Have serviced by a Yamaha dealer.

Q. Is there excess water in fuel filter cup?

A. Drain filter cup.

## **Engine power loss.**

Q. Is propeller damaged?

A. Have propeller repaired or replaced.

Q. Is propeller pitch or diameter incorrect?

A. Install correct propeller to operate outboard at its recommended speed (r/min) range.

Q. Is trim angle incorrect?

A. Adjust trim angle to achieve most efficient operation.

Q. Is motor mounted at incorrect height on transom?

A. Have motor adjusted to proper transom height.

Q. Has alert system activated?

A. Find and correct cause of alert.

Q. Is boat bottom fouled with marine growth?

A. Clean boat bottom.

Q. Are spark plug(s) fouled or of incorrect type?

A. Inspect spark plug(s). Clean or replace with recommended type.

Q. Are weeds or other foreign matter tangled on gear housing?

A. Remove foreign matter and clean lower unit.

Q. Is fuel system obstructed?

A. Check for pinched or kinked fuel line or other obstructions in fuel system.

Q. Is fuel filter clogged?

A. Clean or replace filter.

Q. Is fuel contaminated or stale?

A. Fill tank with clean, fresh fuel.

# Trouble Recovery

Q. Is spark plug gap incorrect?

A. Inspect and adjust as specified.

Q. Is ignition wiring damaged or poorly connected?

A. Check wires for wear or breaks. Tighten all loose connections. Replace worn or broken wires.

Q. Have electrical parts failed?

A. Have serviced by a Yamaha dealer.

Q. Is specified fuel not being used?

A. Replace fuel with specified type.

Q. Is specified engine oil not being used?

A. Check and replace oil with specified type.

Q. Is thermostat faulty or clogged?

A. Have serviced by a Yamaha dealer.

Q. Is air vent screw closed?

A. Open the air vent screw.

Q. Is fuel pump damaged?

A. Have serviced by a Yamaha dealer.

Q. Is fuel joint connection incorrect?

A. Connect correctly.

Q. Is heat range of spark plug incorrect?

A. Inspect spark plug and replace it with recommended type.

Q. Is engine not responding properly to shift lever position?

A. Have serviced by a Yamaha dealer.

## Engine vibrates excessively.

Q. Is propeller damaged?

A. Have propeller repaired or replaced.

Q. Is propeller shaft damaged?

A. Have serviced by a Yamaha dealer.

Q. Are weeds or other foreign matter tangled on propeller?

A. Remove and clean propeller.

Q. Is motor mounting bolt loose?

A. Tighten bolt.

Q. Is steering pivot loose or damaged?

A. Tighten or have serviced by a Yamaha dealer.

EMU29433

## Temporary action in emergency

EMU29440

### Impact damage

EWM00870



**The outboard motor can be seriously damaged by a collision while operating or trailering. Damage could make the outboard motor unsafe to operate.**

If the outboard motor hits an object in the water, follow the procedure below.



ZMU01814

1. Stop the engine immediately.
2. Inspect the control system and all components for damage. Also inspect the boat for damage.

# Trouble Recovery

- Whether damage is found or not, return to the nearest harbor slowly and carefully.
- Have a Yamaha dealer inspect the outboard motor before operating it again.

EMU29473

## Replacing fuse

If a fuse has blown, remove the electrical cover, open the fuse holder and remove the fuse with a fuse puller (if equipped). Replace it with a spare one of the proper amperage.

EWM00631

### WARNING

**Substituting an incorrect fuse or a piece of wire could allow excessive current flow. This could cause electric system damage and a fire hazard.**

Consult your Yamaha dealer if the new fuse immediately blows again.

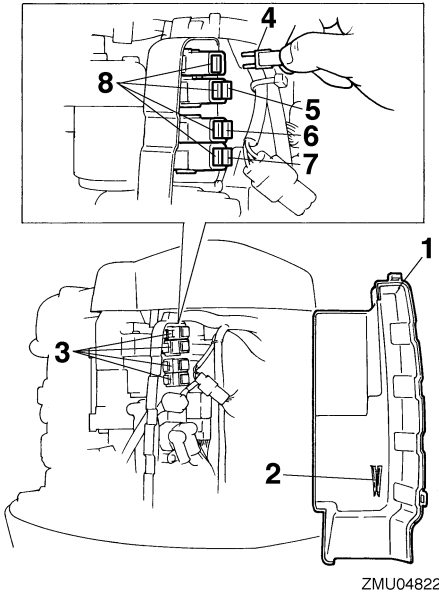

ZMU04822

- Electrical cover
- Fuse puller
- Fuse holder

- Starter relay fuse (30 A)
- Rectifier Regulator (Main) fuse (20 A)
- Main switch / trim switch fuse (20 A)
- Engine control unit / ignition coil / electric fuel pump / fuel injector / ISC (idle speed control) fuse (20 A)
- Spare fuse (20 A, 30 A)

EMU29524

## Power trim and tilt will not operate

If the engine cannot be tilted up or down with the power trim and tilt because of a discharged battery or a failure with the power trim and tilt unit, the engine can be tilted manually.

- Loosen the manual valve screw by turning it counterclockwise until it stops.

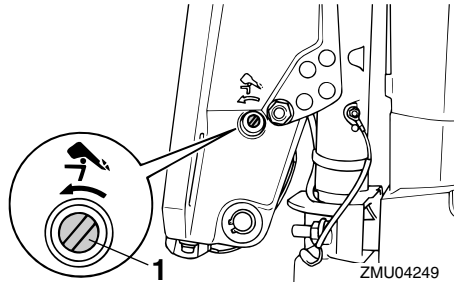

ZMU04249

- Manual valve screw
- Put the engine in the desired position, then tighten the manual valve screw by turning it clockwise.

EMU37580

## Water separator-alert indicator blinks while cruising

EWM01500

### WARNING

**Gasoline is highly flammable, and its vapors are flammable and explosive.**

- Do not perform this procedure on a hot or running engine. Allow the engine to cool.
- There will be fuel in the fuel filter. Keep away from sparks, cigarettes, flames or other sources of ignition.

# Trouble Recovery

- This procedure will allow some fuel to spill. Catch fuel in a rag. Wipe up any spilled fuel immediately.
- The fuel filter must be reassembled carefully with the O-ring, filter cup, and hoses in place. Improper assembly or replacement could result in a fuel leak, which could result in a fire or explosion hazard.

If the water separator-alert indicator on the 6Y8 Multifunction tachometer blinks, perform the following procedure.

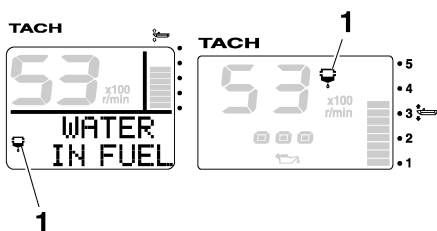

ZMU05442

1. Water separator-alert indicator

1. Stop the engine.
2. Remove the top cowling.
3. Remove the plastic tie.

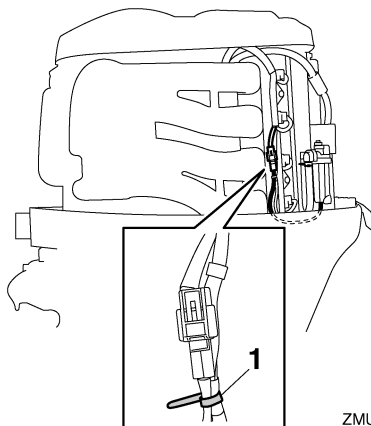

ZMU05657

1. Plastic tie

4. Disconnect the water detection switch coupler. **NOTICE: Be careful not to get any water on the water detection switch coupler, otherwise a malfunction could occur.** [ECM01950]

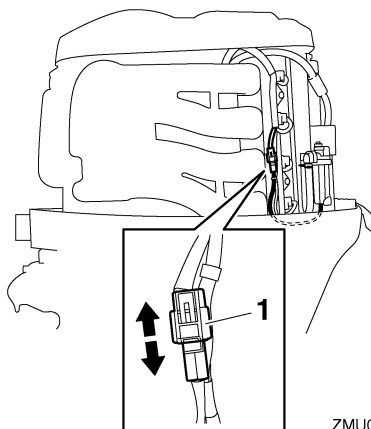

ZMU05658

1. Water detection switch coupler
5. Unscrew the filter cup from the filter housing. **NOTICE: Be careful not to twist the water detection switch lead when unscrewing the filter cup.** [ECM01960]

# Trouble Recovery

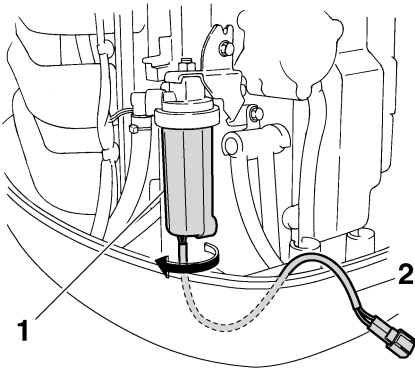

ZMU05450

1. Filter cup
2. Water detection switch lead
6. Drain the water in the filter cup by soaking it up with a rag.
7. Firmly screw the filter cup onto the filter housing. **NOTICE: Be careful not to twist the water detection switch lead when screwing the filter cup onto the filter housing.** [ECM01970]
8. Connect the water detection switch coupler securely until a click is heard.

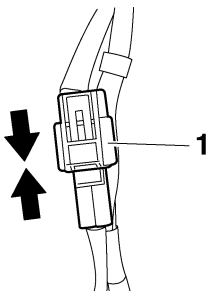

ZMU05659

1. Water detection switch coupler
9. Fasten the water detection switch lead with the plastic tie.

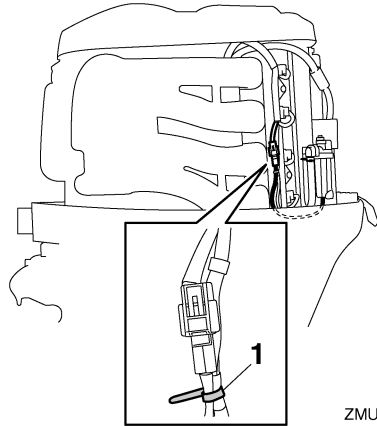

ZMU05660

1. Plastic tie
10. Install the top cowling.
11. Start the engine and make sure that the water separator-alert indicator remains off. Have a Yamaha dealer inspect the outboard motor after returning to port.

EMU29542

## Starter will not operate

If the starter mechanism does not operate (the engine cannot be cranked with the starter), the engine can be started manually with an emergency starter rope. However, the engine cannot be started manually if the battery voltage is low. If the battery is discharged to 9 volts or below, the electric fuel pump will not operate.

EWM01022

## WARNING

- Use this procedure only in an emergency to return to the nearest port for repairs.
- When the emergency starter rope is used to start the engine, the start-in-gear protection device does not operate. Make sure the remote control lever is in



# Trouble Recovery

neutral. Otherwise the boat could unexpectedly start to move, which could result in an accident.

- Attach the engine shut-off cord to a secure place on your clothing, or your arm or leg while operating the boat.
- Do not attach the cord to clothing that could tear loose. Do not route the cord where it could become entangled, preventing it from functioning.
- Avoid accidentally pulling the cord during normal operation. Loss of engine power means the loss of most steering control. Also, without engine power, the boat could slow rapidly. This could cause people and objects in the boat to be thrown forward.
- Make sure no one is standing behind you when pulling the starter rope. It could whip behind you and injure someone.
- An unguarded, rotating flywheel is very dangerous. Keep loose clothing and other objects away when starting the engine. Use the emergency starter rope only as instructed. Do not touch the flywheel or other moving parts when the engine is running. Do not install the starter mechanism or top cowling after the engine is running.
- Do not touch the ignition coil, spark plug wire, spark plug cap, or other electrical components when starting or operating the motor. You could get an electrical shock.

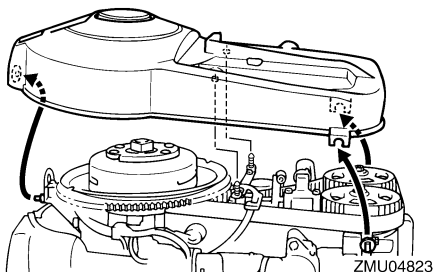

3. Prepare the engine for starting. For further information, see page 48. Be sure the engine is in neutral and that the clip is attached to the engine shut-off switch. The main switch must be "ON" (on).

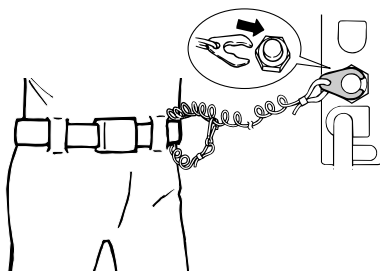
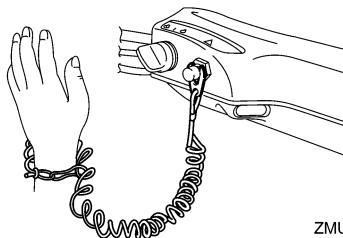

4. Insert the knotted end of the emergency starter rope into the notch in the flywheel rotor and wind the rope around the flywheel clockwise.
5. Pull the rope slowly until resistance is felt.

EMU39160

## Emergency starting engine

1. Remove the top cowling.
2. Lift up the rear of flywheel cover and pull it forward to remove it.

# Trouble Recovery

---

6. Remove the rope from the flywheel temporarily.
7. Rewind the rope around the flywheel approximately 3/4 of a turn clockwise.
8. Give a strong pull straight out to crank and start the engine. Repeat if necessary. **WARNING! Do not install the top cowling when engine is running.**

[EWM00621]

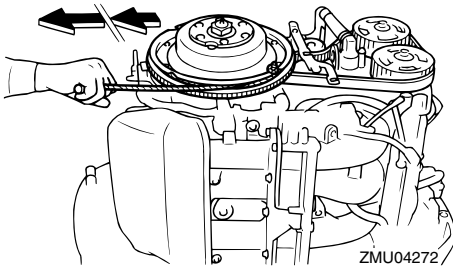

## TIP:

The engine can be started only when the Yamaha Security System is in the unlock mode.

EMU33501

## Treatment of submerged motor

If the outboard motor is submerged, immediately take it to a Yamaha dealer. Otherwise some corrosion may begin almost immediately. **NOTICE: Do not attempt to run the outboard motor until it has been completely inspected.** [ECM00401]





YAMAHA MOTOR CO., LTD.

Printed in Japan

April 2009-0.4 × 1 CR

Printed on recycled paper