



YAMAHA



F4B
F5A
F6C

OWNER'S MANUAL

▲ Read this manual carefully before operating this outboard motor.

6BV-F8199-71-E0

Read this manual carefully before operating this outboard motor. Keep this manual onboard in a waterproof bag when boating. This manual should stay with the outboard motor if it is sold.

Important manual information

EMU25107

To the owner

Thank you for selecting a Yamaha outboard motor. This Owner's Manual contains information needed for proper operation, maintenance and care. A thorough understanding of these simple instructions will help you obtain maximum enjoyment from your new Yamaha. If you have any question about the operation or maintenance of your outboard motor, please consult a Yamaha dealer.

In this Owner's Manual particularly important information is distinguished in the following ways.

 : This is the safety alert symbol. It is used to alert you to potential personal injury hazards. Obey all safety messages that follow this symbol to avoid possible injury or death.

EWMO0781

WARNING

A WARNING indicates a hazardous situation which, if not avoided, could result in death or serious injury.

ECMO0701

NOTICE

A NOTICE indicates special precautions that must be taken to avoid damage to the outboard motor or other property.

TIP:

A TIP provides key information to make procedures easier or clearer.

Yamaha continually seeks advancements in product design and quality. Therefore, while this manual contains the most current product information available at the time of printing, there may be minor discrepancies between

your machine and this manual. If there is any question concerning this manual, please consult your Yamaha dealer.

To ensure long product life, Yamaha recommends that you use the product and perform the specified periodic inspections and maintenance by correctly following the instructions in the owner's manual. Any damage resulting from neglect of these instructions is not covered by warranty.

Some countries have laws or regulations restricting users from taking the product out of the country where it was purchased, and it may be impossible to register the product in the destination country. Additionally, the warranty may not apply in certain regions. When planning to take the product to another country, consult the dealer where the product was purchased for further information.

If the product was purchased used, please consult your closest dealer for customer re-registration, and to be eligible for the specified services.

TIP:

The F4BMH, F5AMH, F6CMH and the standard accessories are used as a base for the explanations and illustrations in this manual. Therefore some items may not apply to every model.

EMU25141

**F4B, F5A, F6C
OWNER'S MANUAL
©2010 by Yamaha Motor Co., Ltd.
1st Edition, March 2010
All rights reserved.
Any reprinting or unauthorized use
without the written permission of
Yamaha Motor Co., Ltd.
is expressly prohibited.
Printed in France**

Table of contents

Safety information	1	Anti-fouling paint	11
Outboard motor safety	1	Motor disposal requirements.....	11
Propeller	1	Emergency equipment.....	11
Rotating parts	1	Components	12
Hot parts.....	1	Components diagram.....	12
Electric shock	1	Fuel tank (built-in fuel tank)	12
Engine shut-off cord (lanyard)	1	Fuel tank (portable fuel tank).....	13
Gasoline	1	Fuel cock	13
Gasoline exposure and spills	1	Tiller handle	14
Carbon monoxide.....	1	Gear shift lever	14
Modifications	2	Throttle grip	14
Boating safety	2	Throttle indicator.....	15
Alcohol and drugs.....	2	Throttle friction adjuster.....	15
Personal flotation devices	2	Engine shut-off cord (lanyard) and	
People in the water.....	2	clip.....	16
Passengers	2	Engine stop button	16
Overloading	2	Choke knob for pull type.....	16
Avoid collisions.....	2	Fuel joint cap	16
Weather.....	3	Manual starter handle.....	17
Passenger training	3	Steering friction adjuster.....	17
Boating safety publications.....	3	Trim rod (tilt pin)	17
Laws and regulations	3	Tilt lock mechanism.....	17
General information	4	Tilt support bar	18
Identification numbers record.....	4	Cowling lock lever	18
Outboard motor serial number	4	Carrying handle	18
EC Declaration of Conformity		Installation	20
(DoC).....	4	Installation.....	20
CE Marking	4	Mounting the outboard motor	20
Read manuals and labels.....	5	Clamping the outboard motor.....	22
Warning labels.....	5	Operation	23
Specifications and requirements	8	First-time operation	23
Specifications	8	Fill engine oil	23
Installation requirements	9	Breaking in engine.....	23
Boat horsepower rating	9	Getting to know your boat	23
Mounting the outboard motor	9	Checks before starting engine	23
Battery requirements	9	Fuel level	23
Propeller selection.....	9	Removing top cowling	24
Start-in-gear protection	10	Fuel system	24
Engine oil requirements	10	Controls	24
Fuel requirements	10	Engine shut-off cord (lanyard)	25
Gasoline	10	Engine oil.....	25
		Engine	26
		Installing top cowling	26

Table of contents

Filling fuel	26	Inspecting idle speed.....	54
Operating engine.....	28	Changing engine oil.....	54
Sending fuel	29	Checking connector and lead.....	56
Starting engine	30	Checking propeller	56
Checks after starting engine	32	Removing propeller	56
Cooling water	32	Installing propeller	57
Warming up engine	33	Changing gear oil	57
Warming up	33	Inspecting and replacing anode (external).....	58
Checks after engine warm up	33	Trouble Recovery.....	60
Shifting	33	Troubleshooting	60
Stop switches	33	Temporary action in emergency ...	62
Shifting	33	Impact damage.....	62
Stopping boat	34	Starter will not operate	62
Stopping engine	34	Emergency engine starting.....	63
Procedure.....	34	Treatment of submerged motor	65
Trimming outboard motor	35		
Adjusting trim angle for manual tilt models	36		
Adjusting boat trim.....	36		
Tilting up and down	37		
Procedure for tilting up	38		
Procedure for tilting down.....	39		
Shallow water.....	39		
Cruising in shallow water.....	39		
Cruising in other conditions.....	41		
Maintenance.....	42		
Transporting and storing outboard motor	42		
Dismounting the outboard motor	42		
Storing outboard motor.....	44		
Procedure.....	45		
Lubrication.....	47		
Cleaning the outboard motor.....	47		
Checking painted surface of outboard motor.....	48		
Periodic maintenance.....	48		
Replacement parts	48		
Severe operating conditions.....	48		
Maintenance chart 1	49		
Maintenance chart 2.....	51		
Greasing.....	52		
Cleaning and adjusting spark plug ...	53		
Checking fuel filter.....	53		

Safety information

EMU33622

Outboard motor safety

Observe these precautions at all times.

EMU36501

Propeller

People can be injured or killed if they come in contact with the propeller. The propeller can keep moving even when the motor is in neutral, and sharp edges of the propeller can cut even when stationary.

- Stop the engine when a person is in the water near you.
- Keep people out of reach of the propeller, even when the engine is off.

EMU33630

Rotating parts

Hands, feet, hair, jewelry, clothing, PFD straps, etc. can become entangled with internal rotating parts of the engine, resulting in serious injury or death.

Keep the top cowling in place whenever possible. Do not remove or replace the cowling with the engine running.

Only operate the engine with the cowling removed according to the specific instructions in the manual. Keep hands, feet, hair, jewelry, clothing, PFD straps, etc. away from any exposed moving parts.

EMU33640

Hot parts

During and after operation, engine parts are hot enough to cause burns. Avoid touching any parts under the top cowling until the engine has cooled.

EMU33650

Electric shock

Do not touch any electrical parts while starting or operating the engine. They can cause shock or electrocution.

EMU33671

Engine shut-off cord (lanyard)

Attach the engine shut-off cord so that the engine stops if the operator falls overboard or leaves the helm. This prevents the boat from

running away under power and leaving people stranded, or running over people or objects.

Always attach the engine shut-off cord to a secure place on your clothing or your arm or leg while operating. Do not remove it to leave the helm while the boat is moving. Do not attach the cord to clothing that could tear loose, or route the cord where it could become entangled, preventing it from functioning.

Do not route the cord where it is likely to be accidentally pulled out. If the cord is pulled during operation, the engine will shut off and you will lose most steering control. The boat could slow rapidly, throwing people and objects forward.

EMU33810

Gasoline

Gasoline and its vapors are highly flammable and explosive. Always, refuel according to the procedure on page 28 to reduce the risk of fire and explosion.

EMU33820

Gasoline exposure and spills

Take care not to spill gasoline. If gasoline spills, wipe it up immediately with dry rags. Dispose of rags properly.

If any gasoline spills onto your skin, immediately wash with soap and water. Change clothing if gasoline spills on it.

If you swallow gasoline, inhale a lot of gasoline vapor, or get gasoline in your eyes, get immediate medical attention. Never siphon fuel by mouth.

EMU33900

Carbon monoxide

This product emits exhaust gases which contain carbon monoxide, a colorless, odorless gas which may cause brain damage or death when inhaled. Symptoms include nausea, dizziness, and drowsiness. Keep cockpit and cabin areas well ventilated. Avoid blocking exhaust outlets.

EMU33780

Modifications

Do not attempt to modify this outboard motor. Modifications to your outboard motor may reduce safety and reliability, and render the outboard unsafe or illegal to use.

EMU33740

Boating safety

This section includes a few of the many important safety precautions that you should follow when boating.

EMU33710

Alcohol and drugs

Never operate after drinking alcohol or taking drugs. Intoxication is one of the most common factors contributing to boating fatalities.

EMU33720

Personal flotation devices

Have an approved personal flotation device (PFD) on board for every occupant. Yamaha recommends that you must wear a PFD whenever boating. At a minimum, children and non-swimmers should always wear PFDs, and everyone should wear PFDs when there are potentially hazardous boating conditions.

EMU33731

People in the water

Always watch carefully for people in the water, such as swimmers, skiers, or divers, whenever the engine is running. When someone is in the water near the boat, shift into neutral and stop the engine.

Stay away from swimming areas. Swimmers can be hard to see.

The propeller can keep moving even when the motor is in neutral. Stop the engine when a person is in the water near you.

EMU33751

Passengers

Consult your boat manufacturer's instructions for details about appropriate passenger locations in your boat and be sure all passengers are positioned properly before accelerating

and when operating above an idle speed. Standing or sitting in non-designated locations may result in being thrown either overboard or within the boat due to waves, wakes, or sudden changes in speed or direction. Even when people are positioned properly, alert your passengers if you must make any unusual maneuver. Always avoid jumping waves or wakes.

EMU33760

Overloading

Do not overload the boat. Consult the boat capacity plate or boat manufacturer for maximum weight and number of passengers. Be sure that weight is properly distributed according to the boat manufacturer's instructions. Overloading or incorrect weight distribution can compromise the boat's handling and lead to an accident, capsizing or swamping.

EMU33772

Avoid collisions

Scan constantly for people, objects, and other boats. Be alert for conditions that limit your visibility or block your vision of others.

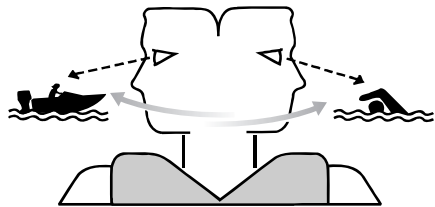

ZMU06025

Operate defensively at safe speeds and keep a safe distance away from people, objects, and other boats.

- Do not follow directly behind other boats or waterskiers.

Safety information

- Avoid sharp turns or other maneuvers that make it hard for others to avoid you or understand where you are going.
- Avoid areas with submerged objects or shallow water.
- Ride within your limits and avoid aggressive maneuvers to reduce the risk of loss of control, ejection, and collision.
- Take early action to avoid collisions. Remember, boats do not have brakes, and stopping the engine or reducing throttle can reduce the ability to steer. If you are not sure that you can stop in time before hitting an obstacle, apply throttle and turn in another direction.

EMU33790

Weather

Stay informed about the weather. Check weather forecasts before boating. Avoid boating in hazardous weather.

EMU33880

Passenger training

Make sure at least one other passenger is trained to operate the boat in the event of an emergency.

EMU33890

Boating safety publications

Be informed about boating safety. Additional publications and information can be obtained from many boating organizations.

EMU33600

Laws and regulations

Know the marine laws and regulations where you will be boating- and obey them. Several sets of rules prevail according to geographic location, but all are basically the same as the International Rules of the Road.

EMU25171

Identification numbers record

EMU25183

Outboard motor serial number

The outboard motor serial number is stamped on the label attached to the port side of the clamp bracket.

Record your outboard motor serial number in the spaces provided to assist you in ordering spare parts from your Yamaha dealer or for reference in case your outboard motor is stolen.

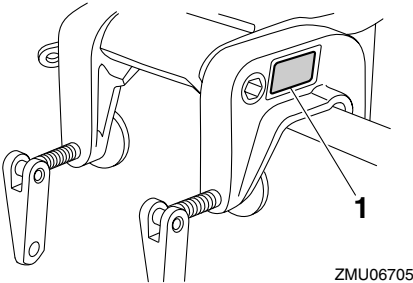

ZMU06705

1. Outboard motor serial number location

- Name of Engine Manufacture
- Model name
- Product code of model (Approved model code)
- Code of conformed directives

EMU25203

CE Marking

Outboard motors affixed with this “CE” marking conform with the directives of; 98/37/EC, 94/25/EC - 2003/44/EC and 2004/108/EC.

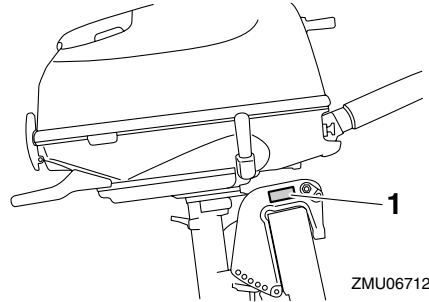

ZMU06712

1. CE marking location

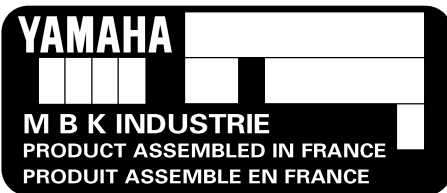

ZMU02115



ZMU06304

EMU37290

EC Declaration of Conformity (DoC)

This outboard motor conforms to certain portions of the European Parliament directive relating to machinery.

Each conformed outboard motor accompanied with EC DoC. EC DoC contains the following information;

General information

EMU33522

Read manuals and labels

Before operating or working on this outboard motor:

- Read this manual.
- Read any manuals supplied with the boat.
- Read all labels on the outboard motor and the boat.

If you need any additional information, contact your Yamaha dealer.

EMU33832

Warning labels

If these labels are damaged or missing, contact your Yamaha dealer for replacements.

F4B, F5A, F6C

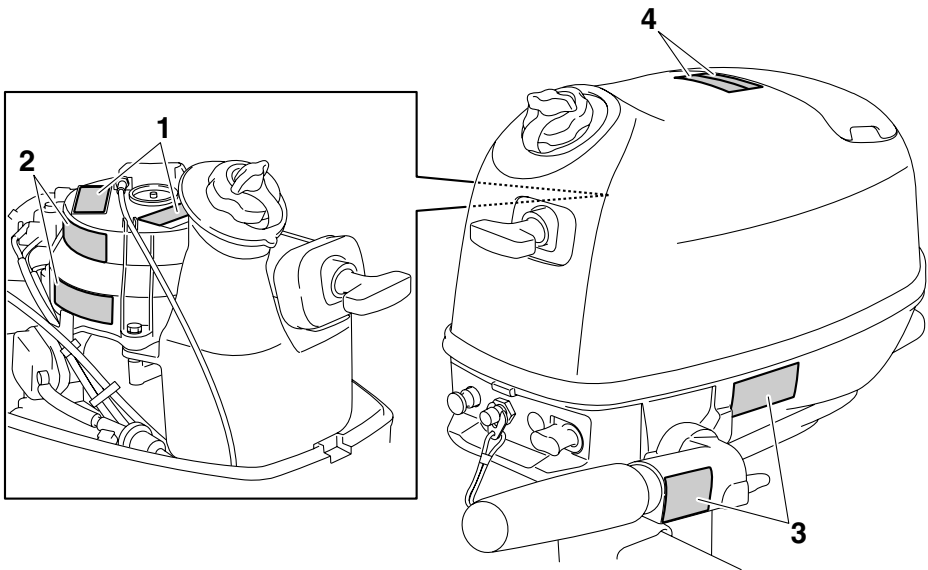

ZMU06795

1



2



3

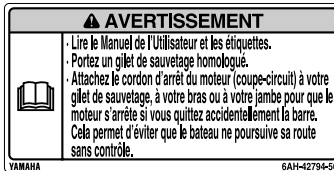
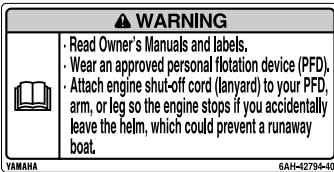

4



EMU35281

Contents of labels

The above warning labels mean as follows.

1

EWM01691

⚠ WARNING
Emergency starting does not have start-in-gear protection. Ensure shift control is in neutral before starting engine.

2

EWM01681

⚠ WARNING

- Keep hands, hair, and clothing away from rotating parts while the engine is running.
- Do not touch or remove electrical parts when starting or during operation.

3

EWM01671

⚠ WARNING

- Read Owner's Manuals and labels.
- Wear an approved personal flotation device (PFD).
- Attach engine shut-off cord (lanyard) to your PFD, arm, or leg so the engine stops if you accidentally leave the helm, which could prevent a runaway boat.

ZMU05920

General information

4

EWM01701



Gasoline is highly flammable and explosive. Shut off engine before refueling. Tighten tank cap and air vent screw when not in use.

EMU35132

Symbols

The following symbols mean as follows.

Notice/Warning



ZMU05696

Read Owner's Manual



ZMU05664

Hazard caused by continuous rotation

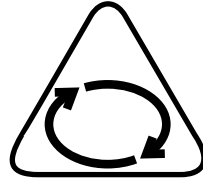

ZMU05665

Electrical hazard

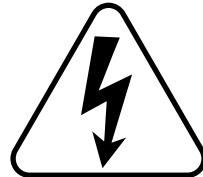

ZMU05666

Specifications and requirements

EMU38090

Specifications

TIP:

“(AL)” stated in the specification data below represents the numerical value for the aluminum propeller installed.

TIP:

“**” means, select the engine oil referring to the chart of engine oil paragraph. For further information, see page 10.

EMU2821J

Dimension:

- Overall length:
750 mm (29.5 in)
- Overall width:
333 mm (13.1 in)
- Overall height S:
1040 mm (40.9 in)
- Overall height L:
1168 mm (46.0 in)
- Transom height S:
440 mm (17.3 in)
- Transom height L:
568 mm (22.4 in)
- Weight (AL) S:
27.0 kg (60 lb)
- Weight (AL) L:
28.0 kg (62 lb)

Performance:

- Full throttle operating range:
F4BMH 4000–5000 r/min
F5AMH 4500–5500 r/min
F6CMH 4500–5500 r/min
- Maximum output:
F4BMH 2.9 kW@4500 r/min (4 HP@4500 r/min)
F5AMH 3.7 kW@5000 r/min (5 HP@5000 r/min)
F6CMH 4.4 kW@5000 r/min (6 HP@5000 r/min)

Idle speed (in neutral):

1500 ±50 r/min

Engine:

- Type:
4-stroke S
- Displacement:
139.0 cm³
- Bore × stroke:
62.0 × 46.0 mm (2.44 × 1.81 in)
- Ignition system:
CDI
- Spark plug (NGK):
CR6HSB
- Spark plug gap:
0.6–0.7 mm (0.024–0.028 in)
- Control system:
Tiller handle
- Starting system:
Manual starter
- Starting carburetion system:
Choke valve
- Valve clearance (cold engine) IN:
0.08–0.12 mm (0.0032–0.0047 in)
- Valve clearance (cold engine) EX:
0.08–0.12 mm (0.0032–0.0047 in)

Drive unit:

- Gear positions:
Forward-neutral-reverse
- Gear ratio:
2.08(27/13)
- Trim and tilt system:
Manual tilt
- Propeller mark:
BA

Fuel and oil:

- Recommended fuel:
Regular gasoline
- Min. research octane:
90
- Fuel tank capacity (built in type):
1.1 L (0.29 US gal, 0.24 Imp.gal)

Specifications and requirements

Recommended engine oil:

4-stroke outboard motor oil

Recommended engine oil group 1*:

SAE 10W-30/10W-40/5W-30

API SE/SF/SG/SH/SJ/SL

Recommended engine oil group 2*:

SAE 15W-40/20W-40/20W-50

API SH/SJ/SL

Engine oil quantity:

0.6 L (0.63 US qt, 0.53 Imp.qt)

Lubrication:

Wet sump

Recommended gear oil:

Hypoid gear oil SAE#90

Gear oil quantity:

0.100 L (0.106 US qt, 0.088 Imp.qt)

Tightening torque for engine:

Spark plug:

13.0 Nm (1.33 kgf-m, 9.6 ft-lb)

Engine oil drain bolt:

18.0 Nm (1.84 kgf-m, 13.3 ft-lb)

Noise and vibration level:

Operator sound pressure level (ICOMIA

39/94 and 40/94):

77.5 dB(A)

Vibration on tiller handle (ICOMIA 38/94):

5.5 m/s²

EMU33554

Installation requirements

EMU33564

Boat horsepower rating

EWM01560



Overpowering a boat can cause severe instability.

Before installing the outboard motor(s), confirm that the total horsepower of your outboard motor(s) does not exceed the boat's maximum horsepower rating. See the boat's capacity plate or contact the manufacturer.

EMU40170

Mounting the outboard motor

EWM02430



Improper mounting of the outboard motor could result in hazardous conditions, such as poor handling, loss of control, or fire hazards. If you are not able to mount the outboard motor properly, consult a Yamaha dealer.

To lift and mount the outboard motor, two people are necessary. For further information, see page 20.

EMU40050

Battery requirements

When installing a battery, the lighting coil kit must be installed. For installation of the battery and lighting coil kit, consult a Yamaha dealer.

EMU34194

Propeller selection

Next to selecting an outboard motor, selecting the right propeller is one of the most important purchasing decisions a boater can make. The type, size, and design of your propeller have a direct impact on acceleration, top speed, fuel economy, and even engine life. Yamaha designs and manufactures propellers for every Yamaha outboard motor and every application.

Your outboard motor came with a Yamaha propeller selected to perform well over a range of applications, but there may be uses where a different propeller would be more appropriate.

Your Yamaha dealer can help you select the right propeller for your boating needs. Select a propeller that will allow the engine to reach the middle or upper half of the operating range at full throttle with the maximum boatload. Generally, select a larger pitch propeller for a smaller operating load and a smaller

Specifications and requirements

pitch propeller for a heavier load. If you carry loads that vary widely, select the propeller that lets the engine run in the proper range for your maximum load but remember that you may need to reduce your throttle setting to stay within the recommended engine speed range when carrying lighter loads.

To check the propeller, see page 56.

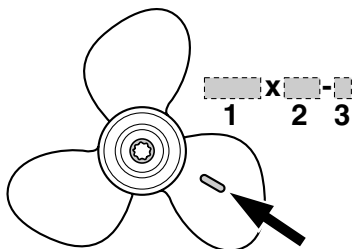

ZMU06853

1. Propeller diameter in inches
2. Propeller pitch in inches
3. Type of propeller (propeller mark)

EMU39190

Start-in-gear protection

Yamaha outboard motors are equipped with start-in-gear protection device. This feature permits the engine to be started only when it is in neutral. Always select neutral before starting the engine.

EMU39691

Engine oil requirements

Select an oil grade according to the average temperatures in the area where the outboard motor will be used.

Recommended engine oil:
4-stroke outboard motor oil
Recommended engine oil group 1*:
SAE 10W-30/10W-40/5W-30
API SE/SF/SG/SH/SJ/SL
Recommended engine oil group 2*:
SAE 15W-40/20W-40/20W-50
API SH/SJ/SL
Engine oil quantity:
0.6 L (0.63 US qt, 0.53 Imp.qt)

If oil grades in recommended engine oil group 1 are not available, select an alternative oil grade from recommended engine oil group 2.

Recommended engine oil group 1

SAE								API
-4	14	32	50	68	86	104	122	F
-20	-10	0	10	20	30	40	50	C
10W-30								SE SF SG SH SJ SL
10W-40								
5W-30								

ZMU06854

Recommended engine oil group 2

SAE								API
-4	14	32	50	68	86	104	122	F
-20	-10	0	10	20	30	40	50	C
15W-40								SH SJ SL
20W-40								
20W-50								

ZMU06855

EMU36360

Fuel requirements

EMU40200

Gasoline

Use a good quality gasoline that meets the minimum octane rating. If knocking or pinging occurs, use a different brand of gasoline or premium unleaded fuel.

Recommended fuel:
Regular gasoline
Min. research octane:
90

ECM01981

NOTICE

- Do not use leaded gasoline. Leaded gasoline can seriously damage the engine.

Specifications and requirements

- **Avoid getting water and contaminants in the fuel tank. Contaminated fuel can cause poor performance or engine damage. Use only fresh gasoline that has been stored in clean containers.**

EMU36330

Anti-fouling paint

A clean hull improves boat performance. The boat bottom should be kept as clean of marine growth as possible. If necessary, the boat bottom can be coated with an anti-fouling paint approved for your area to inhibit marine growth.

Do not use anti-fouling paint which includes copper or graphite. These paints can cause more rapid engine corrosion.

EMU36341

Motor disposal requirements

Never illegally discard (dump) the motor. Yamaha recommends consulting the dealer about discarding the motor.

EMU36352

Emergency equipment

Keep the following items onboard in case there is trouble with the outboard motor.

- A tool kit with assorted screwdrivers, pliers, wrenches (including metric sizes), and electrical tape.
- Waterproof flashlight with extra batteries.
- An extra engine shut-off cord (lanyard) with clip.
- Spare parts, such as an extra set of spark plugs.

Consult your Yamaha dealer for details.

EMU2579V

Components diagram

TIP:

* May not be exactly as shown; also may not be included as standard equipment on all models (order from dealer).

F4B, F5A, F6C

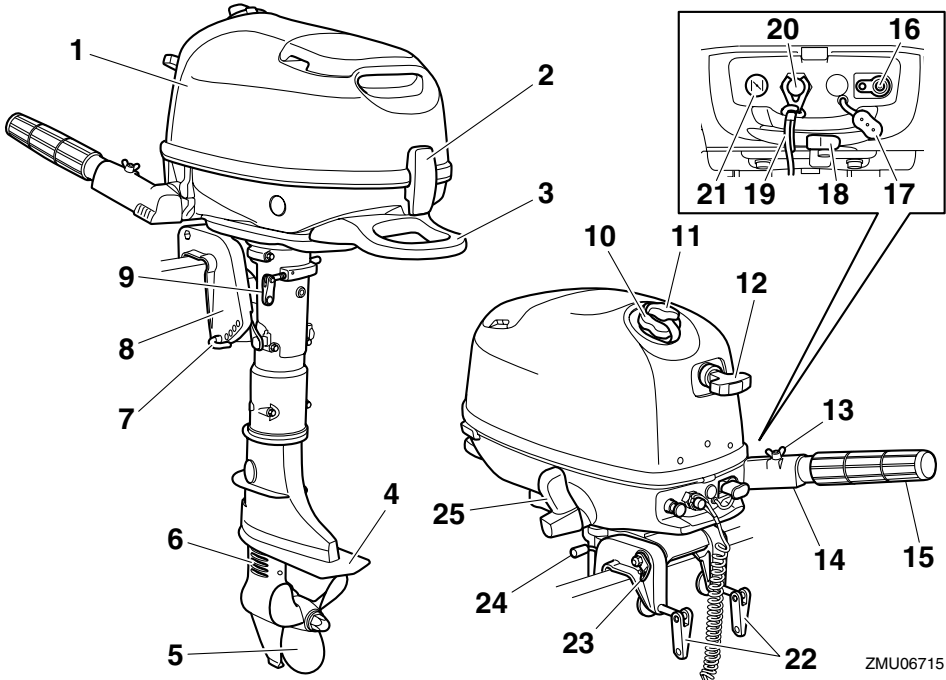

ZMU06715

1. Top cowling
2. Cowling lock lever
3. Carrying handle
4. Anti-cavitation plate
5. Propeller*
6. Cooling water inlet
7. Trim rod
8. Clamp bracket
9. Steering friction adjuster
10. Fuel tank cap
11. Air vent screw
12. Manual starter handle
13. Throttle friction adjuster
14. Tiller handle
15. Throttle grip

16. Fuel joint
17. Fuel joint cap
18. Fuel cock
19. Engine shut-off cord (lanyard)
20. Engine stop button
21. Choke knob
22. Clamp screw
23. Restraint cable attachment
24. Tilt support bar
25. Gear shift lever

EMU39542

Fuel tank (built-in fuel tank)

This outboard motor is equipped with a built-in fuel tank and its parts are as follows.

Components

Fuel tank cap

This cap seals the fuel tank. When removed, the tank can be filled with fuel. To remove the cap, turn it counterclockwise.

Air vent screw

This screw is on the fuel tank cap. To loosen the screw, turn it counterclockwise.

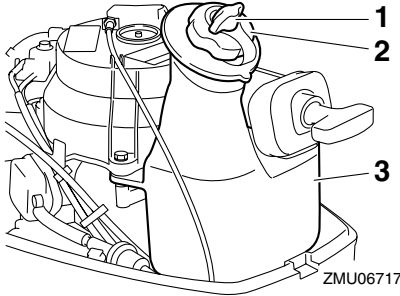

1. Air vent screw
2. Fuel tank cap
3. Built-in fuel tank

EMU39353

Fuel tank (portable fuel tank)

This model can be equipped with an optional portable fuel tank. The parts of the fuel tank are as follows.

Fuel tank cap

This cap seals the fuel tank. When removed, the tank can be filled with fuel. To remove the cap, turn it counterclockwise.

Air vent screw

This screw is on the fuel tank cap. To loosen the screw, turn it counterclockwise.

Fuel joint

This joint is used to connect the fuel line.

Fuel gauge

This gauge is located on either the fuel tank cap or on the fuel joint base. It shows the approximate amount of fuel remaining in the tank.

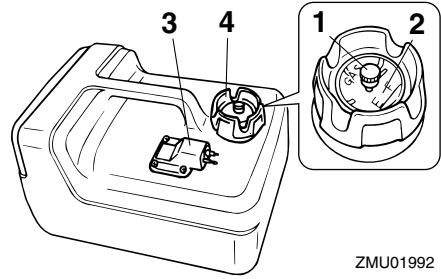

1. Air vent screw
2. Fuel gauge
3. Fuel joint
4. Fuel tank cap

EWM02380

WARNING

Do not use the portable fuel tank as a fuel storage container. Commercial users should conform to relevant licensing or approval authority regulations.

EMU40090

Fuel cock

The fuel cock turns on and off the supply of fuel from the fuel tank to the engine.

The fuel cock has 3 positions: the closed position, built-in fuel tank position, and portable fuel tank position. Depending on how the outboard motor will be used, align the fuel cock with the appropriate position indicated on the label that is affixed to the outboard motor.

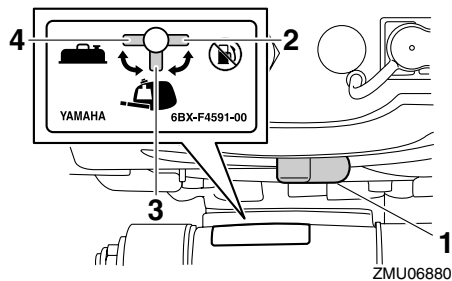

1. Fuel cock
2. Closed position

3. Built-in fuel tank position
4. Portable fuel tank position

EMU39210

Close

To stop the fuel flow from the fuel tank to the carburetor, align the fuel cock with the closed position.

When the engine is not running, always align the fuel cock with the closed position.

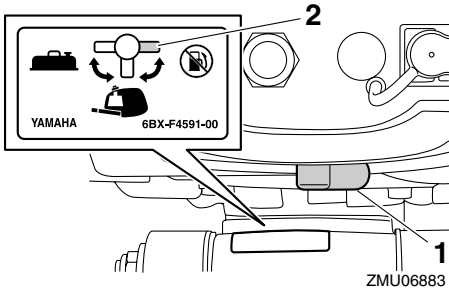

1. Fuel cock
2. Closed position

EMU39222

Open

To send fuel from the fuel tank to the carburetor, align the fuel cock with the position for the built-in fuel tank or portable fuel tank according to which fuel tank is being used.

When using the built-in fuel tank, align the fuel cock with the built-in fuel tank position.

When using a portable fuel tank, align the fuel cock with the portable fuel tank position.

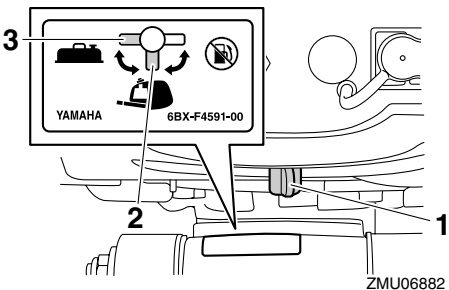

1. Fuel cock

2. Built-in fuel tank position
3. Portable fuel tank position

EMU25912

Tiller handle

To change direction, move the tiller handle to the left or right as necessary.

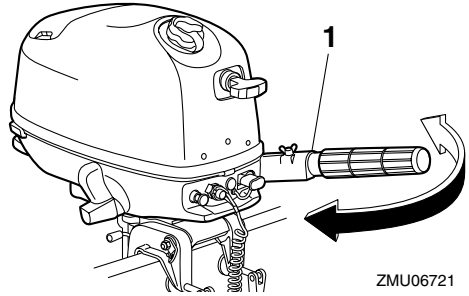

1. Tiller handle

EMU25923

Gear shift lever

Move the gear shift lever forward to engage the forward gear or rearward to engage the reverse gear.

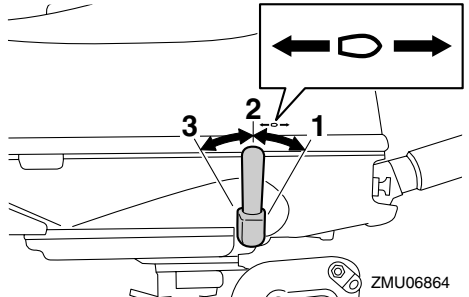

1. Forward position
2. Neutral position
3. Reverse position

EMU39700

Throttle grip

The throttle grip is on the tiller handle. Turn the grip "A" to increase speed and "B" to decrease speed.

Components

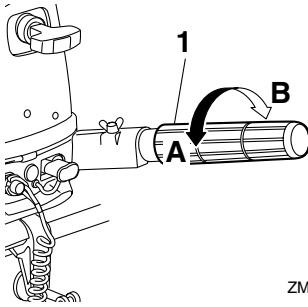

1. Throttle grip

EMU39711

Throttle indicator

The throttle indicator shows the throttle position. When the 100% position of the throttle indicator is aligned with the notch in the tiller handle, the throttle is fully open. When the 0% position of the throttle indicator is aligned with the notch in the tiller handle, the throttle is fully closed.

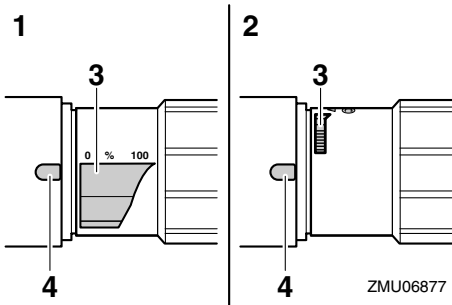

1. Fully open
2. Fully closed
3. Throttle indicator
4. Notch

The engine start mark “” on the throttle indicator shows the throttle position for starting the engine.

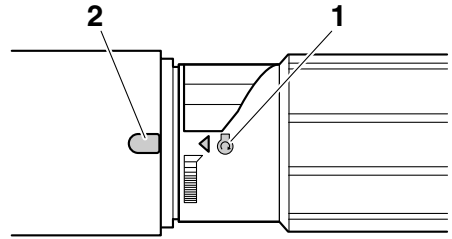

1. Start mark “”
2. Notch

EMU39242

Throttle friction adjuster

The throttle friction adjuster provides adjustable resistance when the throttle grip is turned, and can be set according to operator preference.

To increase resistance, turn the throttle friction adjuster clockwise.

To decrease resistance, turn the throttle friction adjuster counterclockwise. When constant speed is desired, tighten the throttle friction adjuster to maintain the desired throttle setting. **WARNING! Do not overtighten the throttle friction adjuster. If there is too much resistance, it could be difficult to turn the throttle grip, which could result in an accident.** [EWM02261]

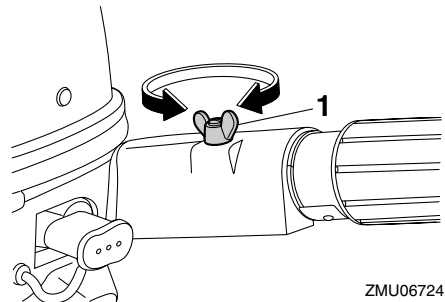

1. Throttle friction adjuster

EMU25994

Engine shut-off cord (lanyard) and clip

The clip must be attached to the engine shut-off switch for the engine to run. The cord should be attached to a secure place on the operator's clothing, or arm or leg. Should the operator fall overboard or leave the helm, the cord will pull out the clip, stopping ignition to the engine. This will prevent the boat from running away under power. **WARNING! Attach the engine shut-off cord to a secure place on your clothing, or your arm or leg while operating. Do not attach the cord to clothing that could tear loose. Do not route the cord where it could become entangled, preventing it from functioning. Avoid accidentally pulling the cord during normal operation. Loss of engine power means the loss of most steering control. Also, without engine power, the boat could slow rapidly. This could cause people and objects in the boat to be thrown forward.**

[EWM00122]

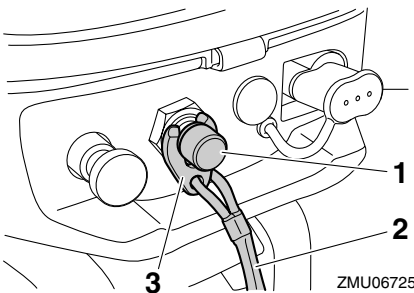

ZMU06725

1. Engine shut-off switch
2. Cord
3. Clip

EMU26002

Engine stop button

The engine stop button stops the engine when the button is pushed.

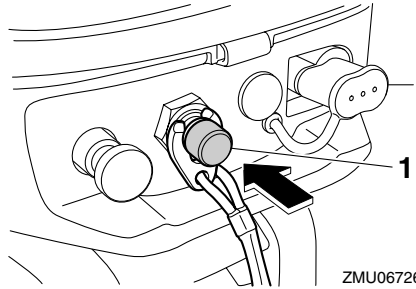

ZMU06726

1. Engine stop button

EMU26012

Choke knob for pull type

To supply the engine with the rich fuel mixture required to start, pull out this knob.

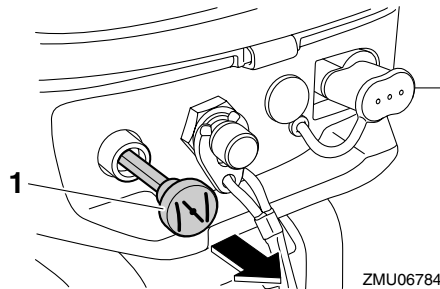

ZMU06784

1. Choke knob

EMU39722

Fuel joint cap

The fuel joint is equipped with the fuel joint cap. **WARNING! When not using a portable fuel tank, make sure to install the fuel joint cap. Otherwise, injury could result from striking the fuel joint accidentally.** [EWM02411]

Components

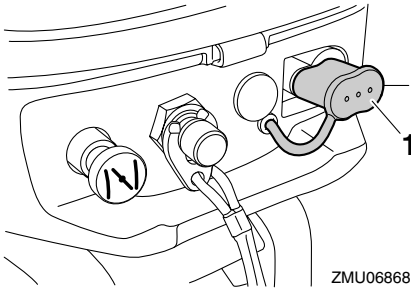

1. Fuel joint cap

EMU26073

Manual starter handle

The manual starter handle is used to crank and start the engine.

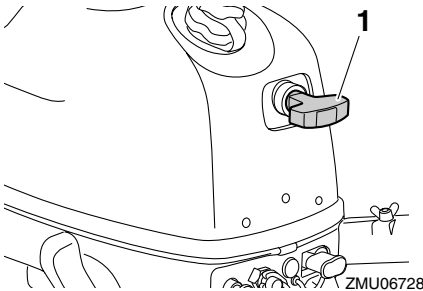

1. Manual starter handle

EMU39252

Steering friction adjuster

EWM02270



WARNING

Do not overtighten the steering friction adjuster. If there is too much resistance, it could be difficult to steer, which could result in an accident.

The steering friction adjuster provides adjustable resistance to the steering mechanism, and can be set according to operator preference. The steering friction adjuster is located on the port side of the outboard motor.

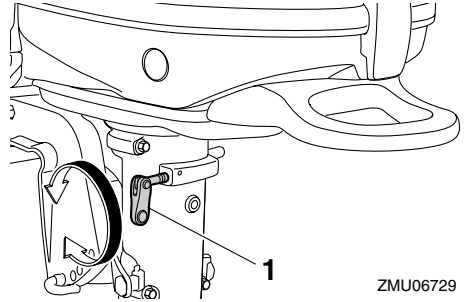

1. Steering friction adjuster

To increase resistance, turn the steering friction adjuster clockwise.

To decrease resistance, turn the steering friction adjuster counterclockwise.

EMU40100

Trim rod (tilt pin)

The trim rod (tilt pin) is used to adjust the trim angle of the outboard motor in relation to the angle of the boat transom.

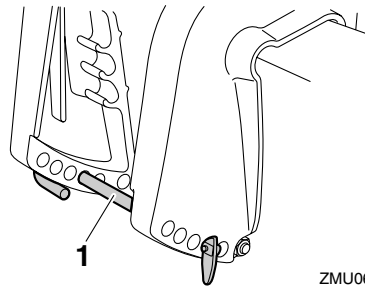

1. Trim rod

EMU39362

Tilt lock mechanism

The tilt lock mechanism is used to prevent the outboard motor from lifting out of the water when the gear shift lever is in the reverse position.

When the gear shift lever is moved to the reverse position, the tilt lock mechanism operates to prevent the outboard motor from being tilted up.

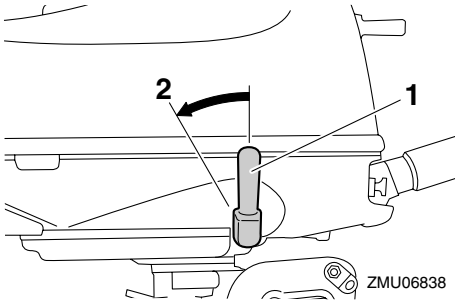

1. Gear shift lever
2. Reverse position

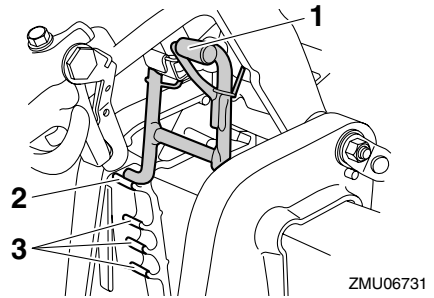

1. Tilt support bar
2. Tilted up position
3. Shallow water cruising position

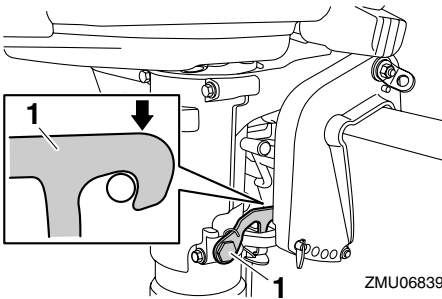

1. Tilt lock

When the gear shift lever is moved to the neutral position or forward position, the outboard motor can be tilted up.

EMU39831

Tilt support bar

Use the tilt support bar to keep the outboard motor in the tilted up position or a shallow water cruising position.

EMU39261

Cowling lock lever

The cowling lock lever is used to secure the top cowling.

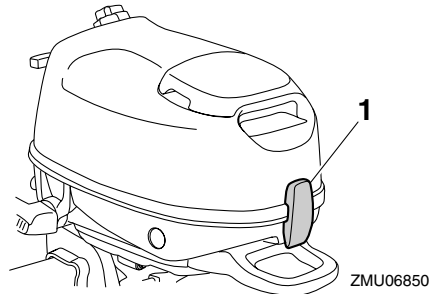

1. Cowling lock lever

EMU39372

Carrying handle

The carrying handle is used to carry the outboard motor. For information on carrying and transporting the outboard motor, see page 42.

Components

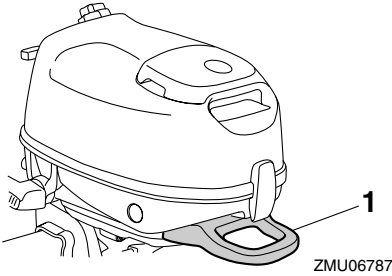

1. Carrying handle

EMU39731

Installation

The information presented in this section is intended as reference only. It is not possible to provide complete instructions for every possible boat and motor combination. Proper mounting depends in part on experience and the specific boat and motor combination.

EWM02341

WARNING

- **Overpowering a boat could cause severe instability. Do not mount an outboard motor with more horsepower than the maximum rating on the capacity plate of the boat. If the boat does not have a capacity plate, consult the boat manufacturer.**
- **Improper mounting of the outboard motor could result in hazardous conditions, such as poor handling, loss of control, or fire hazards. If you are not able to mount the outboard motor properly, consult a Yamaha dealer.**

EMU39562

Mounting the outboard motor

EWM02300

WARNING

Do not hold the top cowling or tiller handle when mounting or dismounting the outboard motor. Otherwise, the outboard motor could fall.

1. Be sure to mount the outboard motor while the boat is on land. If the boat is on the water, move it to an area on land.
2. To prevent steering movement, turn the steering friction adjuster clockwise.

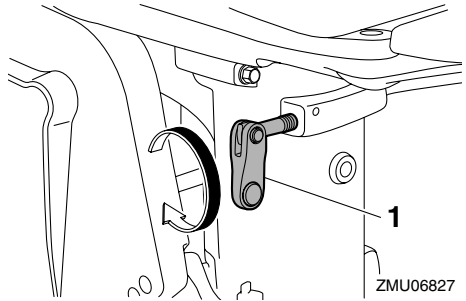

1. Steering friction adjuster
3. Turn the tiller handle 180° so that it is pointing rearward.

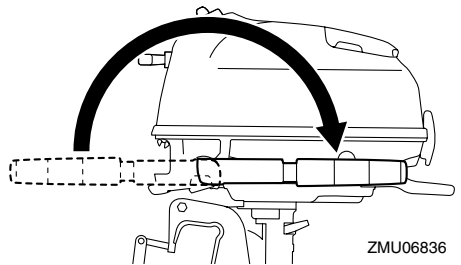

4. Hold the carrying handle and the handgrip on the front side of the bottom cowling and lift up the outboard motor using two people.

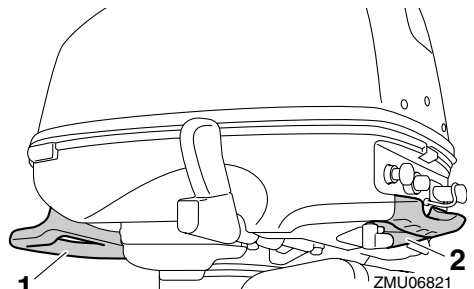

1. Carrying handle
2. Handgrip

Installation

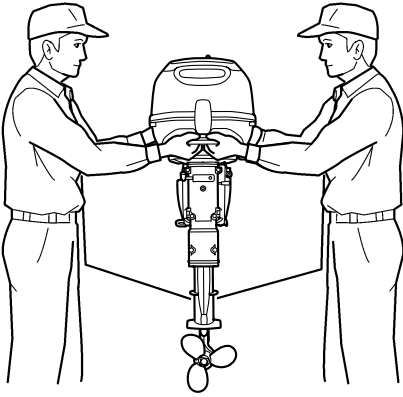

ZMU06835

5. Mount the outboard motor on the center line (keel line) of the boat, and ensure that the boat itself is well balanced. Otherwise the boat will be hard to steer. For boats without a keel or which are asymmetrical, consult your dealer.

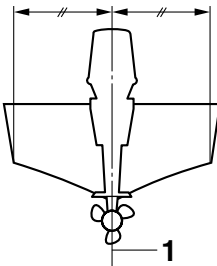

ZMU01760

1. Center line (keel line)
6. Turn the steering friction adjuster counterclockwise to set the steering friction according to operator preference. **WARNING! If there is too much resistance it could be difficult to steer, which could result in an accident.**

[EWM00721]

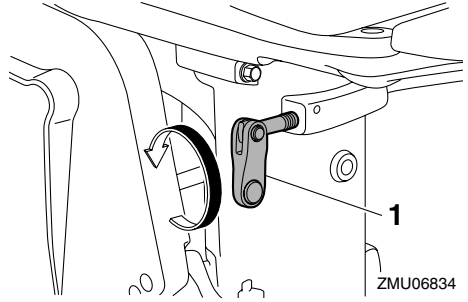

1. Steering friction adjuster

EMU39740

Mounting height

To run your boat at optimum efficiency, the water resistance (drag) of the boat and outboard motor must be made as little as possible. The mounting height of the outboard motor greatly affects the water resistance. If the mounting height is too high, cavitation tends to occur, thus reducing the propulsion; and if the propeller tips cut the air, the engine speed will rise abnormally and cause the engine to overheat. If the mounting height is too low, the water resistance will increase and thereby reduce engine efficiency. Mount the outboard motor so that the anti-cavitation plate is between the bottom of the boat and a level 25 mm (1 in) below it.

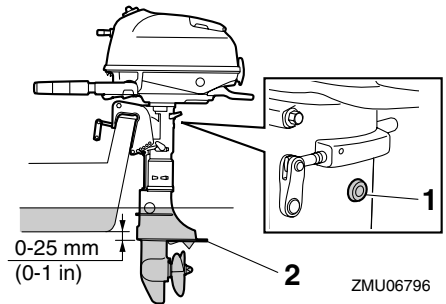

1. Idle hole
2. Anti-cavitation plate

ZMU06796

ECM02170

NOTICE

- Check that the idle hole stays high enough to keep out water getting inside engine even if the boat is in stationary with maximum load.
- Incorrect engine height or obstructions to the smooth flow of water (such as the design or condition of the boat) can create airborne water spray while the boat is cruising. If the motor is operated continuously in the presence of airborne water spray, enough water could enter the engine through the intake opening on the top cowling to cause severe engine damage. Eliminate the cause of the airborne water spray.

TIP:

- The optimum mounting height of the outboard motor is affected by the boat and motor combination and the desired use. Test runs at different heights can help determine the optimum mounting height. Consult your Yamaha dealer or boat manufacturer for further information on determining the proper mounting height.
- For instructions on setting the trim angle of the outboard motor, see page 35.

EMU39751

Clamping the outboard motor

1. Place the outboard motor on the transom so that it is positioned as close to the center as possible. Tighten the clamp screws evenly and securely. Occasionally check the clamp screws for tightness during operation of the outboard motor because they could become loose due to engine vibration. **WARNING! Loose clamp screws could allow the outboard motor to fall off or move on the transom. This could cause loss of control and**

serious injury. Make sure the clamp screws are tightened securely. Occasionally check the screws for tightness during operation. [EWM00642]

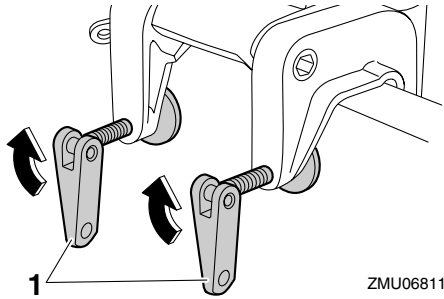

1. Clamp screw
2. Attach one end to the restraint cable attachment and the other to a secure mounting point on the boat. Otherwise the engine could be completely lost if it accidentally falls off the transom.

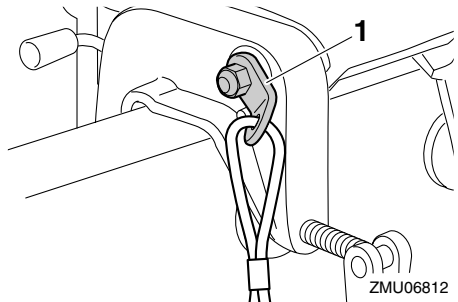

1. Restraint cable attachment

Operation

EMU36381

First-time operation

EMU36391

Fill engine oil

The engine is shipped from the factory without engine oil. If your dealer did not fill the oil, you must fill it before starting the engine. **NOTICE: Check that the engine is filled with oil before first-time operation to avoid severe engine damage.** [ECM01781]

The engine is shipped with the following sticker, which should be removed after engine oil is filled for the first time. For more information on checking the engine oil level, see page 25.



ZMU01710

EMU30174

Breaking in engine

Your new engine requires a period of break-in to allow mating surfaces of moving parts to wear in evenly. Correct break-in will help ensure proper performance and longer engine life. **NOTICE: Failure to follow the break-in procedure could result in reduced engine life or even severe engine damage.** [ECM00801]

EMU40060

Procedure for 4-stroke models

Your new engine requires a period of 10 hours break-in to allow mating surfaces of moving parts to wear in evenly.

TIP:

Run the engine in the water, under load (in gear with a propeller installed) as follows. For 10 hours for breaking in engine avoid extended idling, rough water and crowded areas.

1. For the first hour of operation:
Run the engine at varying speeds up to 2000 r/min or approximately half throttle.
2. For the second hour of operation:
Run the engine at 3000 r/min or at approximately three-quarter throttle.
3. Remaining 8 hours:
Run the engine at any speed. However, avoid operating at full throttle for more than 5 minutes at a time.
4. After the first 10 hours:
Operate the engine normally.

EMU36400

Getting to know your boat

Different boats handle differently. Operate cautiously while you learn how your boat handles under different conditions and with different trim angles (see page 35).

EMU36413

Checks before starting engine

EWM01921

WARNING

If any item in “Checks before starting engine” is not working properly, have it inspected and repaired before operating the outboard motor. Otherwise, an accident could occur.

ECM00120

NOTICE

Do not start the engine out of water. Overheating and serious engine damage can occur.

EMU36560

Fuel level

Be sure you have plenty of fuel for your trip. A good rule is to use 1/3 of your fuel to get to the destination, 1/3 to return, and to keep 1/3 as an emergency reserve. With the boat level on a trailer or in the water, check the fuel level. For fuel filling instructions, see page 26.

EMU39840

Removing top cowling

For the following checks, remove the top cowling from the bottom cowling.

To remove the top cowling, pull the cowling lock lever up and lift up the top cowling.

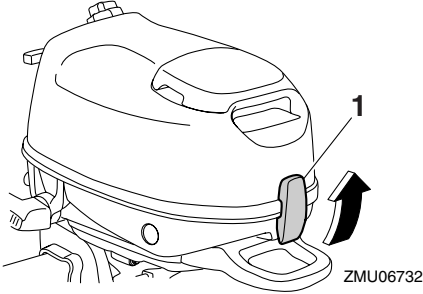

1. Cowling lock lever

EMU36442

Fuel system

EWM00060

! WARNING

Gasoline and its vapors are highly flammable and explosive. Keep away from sparks, cigarettes, flames, or other sources of ignition.

EWM00910

! WARNING

Leaking fuel can result in fire or explosion.

- Check for fuel leakage regularly.
- If any fuel leakage is found, the fuel system must be repaired by a qualified mechanic. Improper repairs can make the outboard unsafe to operate.

EMU36451

Check for fuel leaks

- Check for fuel leaks or gasoline fumes in the boat.
- Check for fuel leakage from the fuel system.
- Check the fuel tank and fuel lines for cracks, swellings, or other damages.

EMU39851

Controls

- Move the tiller handle fully to the left and right to check that operation is smooth.
- Turn the throttle grip from the fully closed position to the fully open position. Check that the throttle grip turns smoothly and that it completely returns to the fully closed position.
- Check the throttle cable and throttle link for loose or damaged connections.

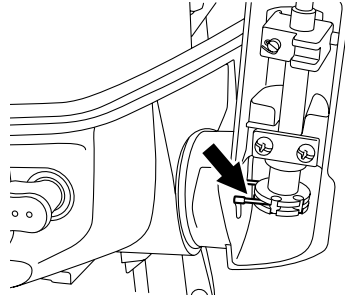

ZMU06851

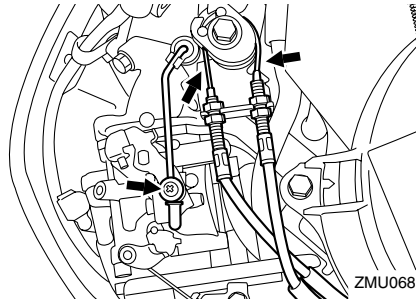

ZMU06852

- Check the shift link and start-in-gear protection cable for loose or damaged connections.

Operation

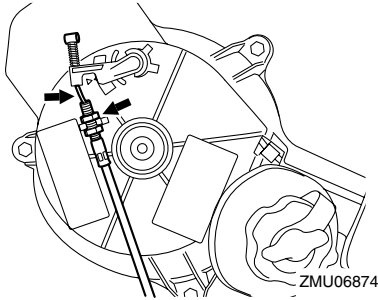

EMU36483

Engine shut-off cord (lanyard)

Inspect the engine shut-off cord and clip for damage, such as cuts, breaks, and wear.

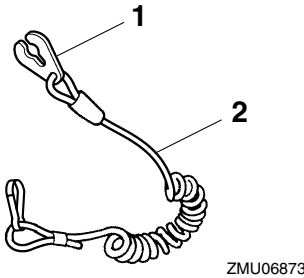

1. Clip
2. Cord

EMU39383

Engine oil

1. Place the outboard motor in an upright position (not tilted). **NOTICE: If the motor is not level, the oil level indicated on the dipstick may not be accurate.**

[ECM01790]

2. Remove the oil filler cap and wipe the attached oil dipstick clean.

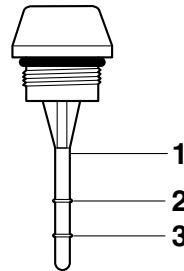

1. Oil dipstick
2. Upper mark
3. Lower mark

5. Install the oil filler cap and tighten it completely.

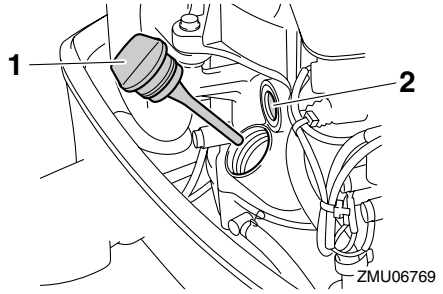

1. Oil filler cap
2. Oil lubrication check window

TIP:

The oil lubrication check window does not indicate the engine oil level. Use the oil lubrication check window to make sure that the engine is being lubricated with oil while it is running.

3. Install the oil filler cap and tighten it completely.
4. Remove the oil filler cap again and check that the oil level on the dipstick is between the upper and lower marks. If the oil level is not at the proper level, add or extract oil until the oil is between the upper and lower marks.

EMU27153

Engine

- Check the engine and engine mounting.
- Look for loose or damaged fasteners.
- Check the propeller for damage.
- Check for engine oil leaks.

EMU39861

Installing top cowling

1. Check the rubber seal for damage. If the rubber seal is damaged, have it replaced by a Yamaha dealer.
2. Align the fuel tank cap and manual starter handle with their respective holes in the top cowling.

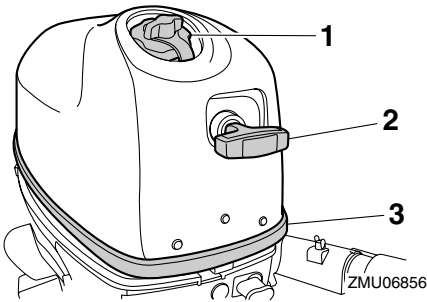

1. Fuel tank cap
 2. Manual starter handle
 3. Rubber seal
3. Hook the top cowling hook onto the bottom cowling, and then make sure that the fuel tank cap and manual starter handle fit properly into their respective holes.

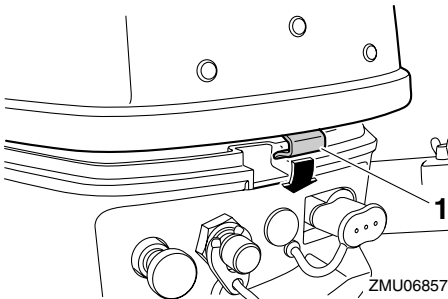

1. Hook

4. Check to be sure the rubber seal is seated correctly between the top cowling and the bottom cowling.
5. Pull the cowling lock lever down to secure the top cowling.

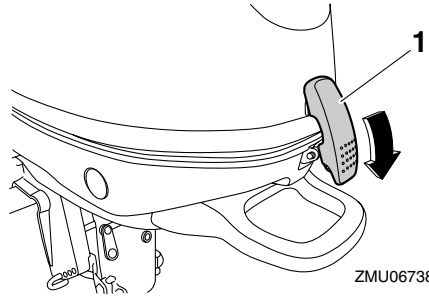

1. Cowling lock lever
6. Check the fitting of the top cowling by pushing it with both hands. **NOTICE: If the top cowling is not installed correctly, water spray under the top cowling can damage the engine, or the top cowling can blow off at high speeds.**

[ECM01991]

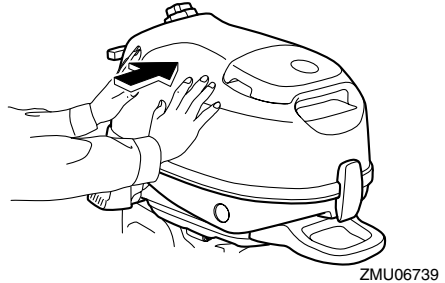

EMU39872

Filling fuel

EWM01950



WARNING

Be sure the outboard motor is securely fastened to the transom or a stable stand.

Operation

EWM01830

WARNING

- Gasoline and its vapors are highly flammable and explosive. Always refuel according to this procedure to reduce the risk of fire and explosion.
- Gasoline is poisonous and can cause injury or death. Handle gasoline with care. Never siphon gasoline by mouth. If you should swallow some gasoline or inhale a lot of gasoline vapor, or get some gasoline in your eyes, see your doctor immediately. If gasoline spills on your skin, wash with soap and water. If gasoline spills on your clothing, change your clothes.

Before refueling, check the following points:

- Securely moor the boat in a well-ventilated area and stop the engine. If the boat is trailered, make sure that it is stable.
- Do not smoke and keep away from sparks, flames, static electric discharge, or other sources of ignition.
- If you use a portable container to store and dispense fuel, only use a locally approved GASOLINE container.
- To prevent electrostatic sparks, discharge any built-up static electricity from your body before refueling.

Filling fuel for built-in fuel tank

1. Remove the fuel tank cap.

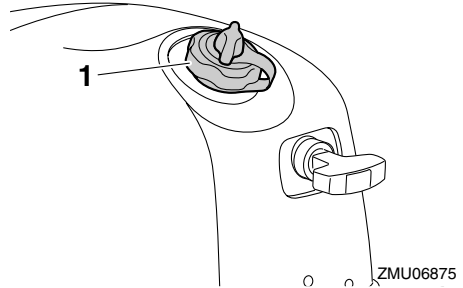

1. Fuel tank cap
2. Fill the fuel tank, but do not overfill it. **WARNING! Do not overfill. Otherwise fuel can expand and overflow if the temperature increases.** [EWM02610]

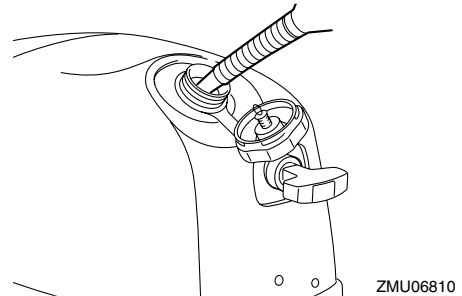

Fuel tank capacity (built in type):
1.1 L (0.29 US gal, 0.24 Imp.gal)

3. Tighten the fuel tank cap securely.
4. Wipe up any spilled gasoline immediately with dry rags. Dispose of rags properly according to local laws or regulations. If you use a portable container to store and dispense fuel, only use a locally approved GASOLINE container.

Filling fuel for portable fuel tank (optional)

1. Disconnect the fuel hose, and then install the fuel joint cap. **WARNING! When not using a portable fuel tank, make sure**

to install the fuel joint cap. Otherwise, injury could result from striking the fuel joint accidentally. [EWM02411]

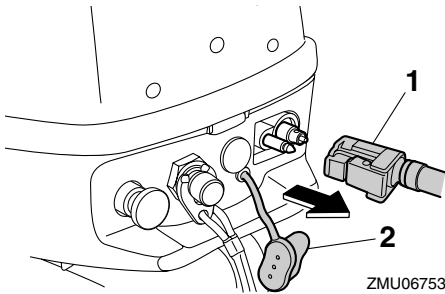

1. Fuel hose
2. Fuel joint cap

2. Remove the portable fuel tank from the boat.
3. Remove the fuel tank cap.

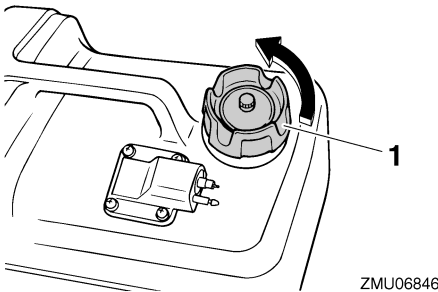

1. Fuel tank cap

4. Fill the fuel tank, but do not overfill it. **WARNING! Do not overfill. Otherwise fuel can expand and overflow if the temperature increases.** [EWM02610]

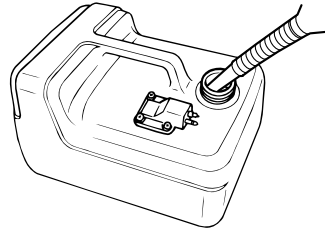

ZMU06832

5. Tighten the fuel tank cap securely.
6. Wipe up any spilled gasoline immediately with dry rags. Dispose of rags properly according to local laws or regulations. If you use a portable container to store and dispense fuel, only use a locally approved GASOLINE container.

EMU27452

Operating engine

EWM00420

WARNING

- Before starting the engine, make sure that the boat is tightly moored and that you can steer clear of any obstructions. Be sure there are no swimmers in the water near you.
- When the air vent screw is loosened, gasoline vapor will be released. Gasoline is highly flammable, and its vapors are flammable and explosive. Refrain from smoking, and keep away from open flames and sparks while loosening the air vent screw.
- This product emits exhaust gases which contain carbon monoxide, a colorless, odorless gas which could cause brain damage or death when inhaled. Symptoms include nausea, dizziness, and drowsiness. Keep cockpit and cabin areas well ventilated. Avoid blocking exhaust outlets.

Operation

EMU39395

Sending fuel

Sending fuel for built-in fuel tank

1. Loosen the air vent screw by 1 or 2 turns.

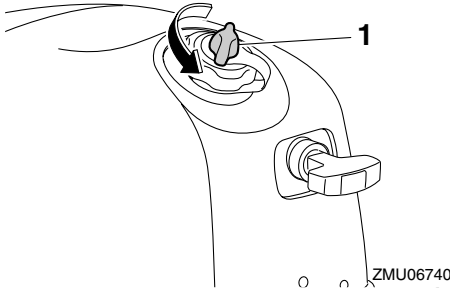

1. Air vent screw
2. Align the fuel cock with the built-in fuel tank position.

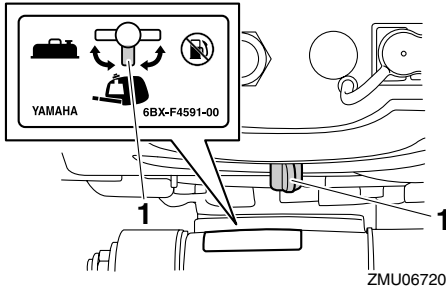

1. Built-in fuel tank position
3. Remove the top cowling, and then squeeze the primer pump in the bottom cowling repeatedly until you feel it become slightly firm.

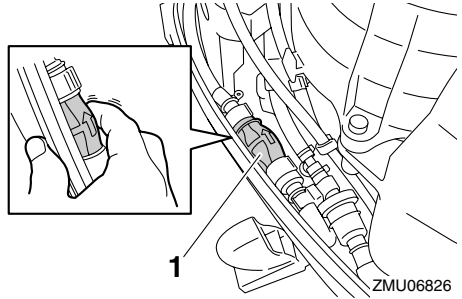

1. Primer pump
4. Install the top cowling.

Sending fuel for portable fuel tank (optional)

1. Loosen the air vent screw on the portable fuel tank by 2 or 3 turns.

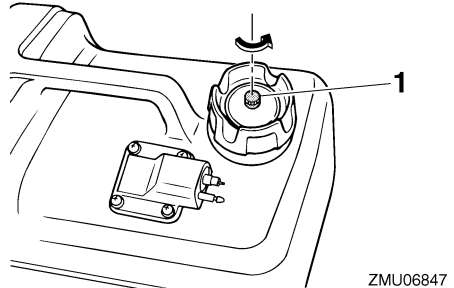

1. Air vent screw
2. If there is fuel in the built-in fuel tank, loosen the air vent screw by 1 or 2 turns to prevent pressure from increasing inside the tank due to fuel expansion.

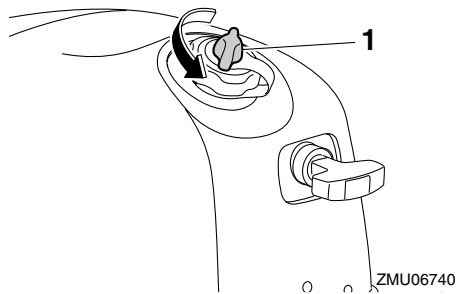

1. Air vent screw

3. Remove the fuel joint cap. Align the fuel joint on the fuel line with the fuel joint on the motor and connect the fuel line securely between the tank and the outboard motor while pinching the joint so that the primer pump arrow is pointing toward the outboard motor.

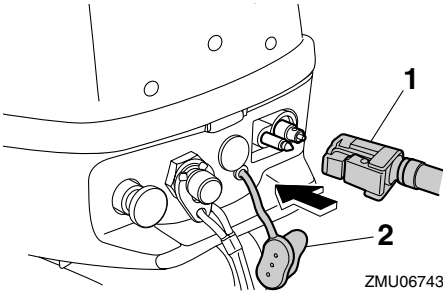

1. Fuel hose
2. Fuel joint cap

ZMU06743

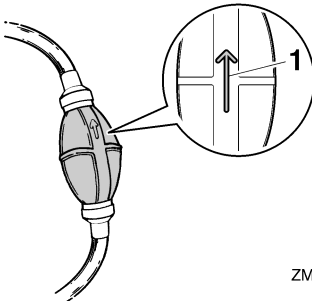

ZMU06869

1. Arrow
4. Align the fuel cock with the portable fuel tank position.

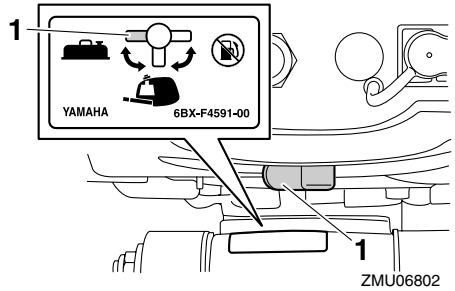

1. Portable fuel tank position
5. Send fuel to the carburetor by squeezing the primer pump repeatedly, with the arrow pointing up, until you feel it become firm. While the engine is running, make sure to keep the portable fuel tank horizontal. Otherwise, fuel cannot be drawn from the fuel tank.

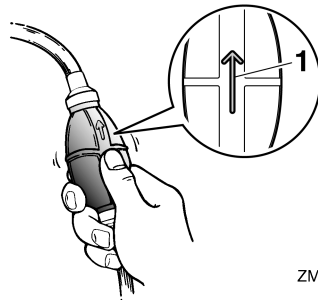

ZMU06848

1. Arrow

EMU27494

Starting engine

EWM01600



WARNING

Before starting the engine, make sure that the boat is tightly moored and that you can steer clear of any obstructions. Be sure there are no swimmers in the water near you.

Operation

EMU39403

Manual start

EWM01840

WARNING

- Failure to attached engine shut-off cord could result in a runaway boat if operator is ejected. Attach the engine shut-off cord to a secure place on your clothing, or your arm or leg while operating. Do not attach the cord to clothing that could tear loose. Do not route the cord where it could become entangled, preventing it from functioning.
- Avoid accidentally pulling the cord during normal operation. Loss of engine power means the loss of most steering control. Also, without engine power, the boat could slow rapidly. This could cause people and objects in the boat to be thrown forward.

1. Move the gear shift lever to the neutral position.

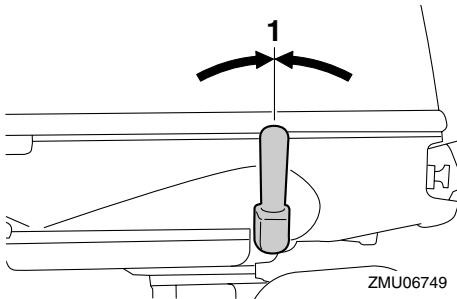

1. Neutral position
2. Attach the engine shut-off cord to a secure place on your clothing, or your arm or leg. Then, install the clip on the other end of the cord to the engine shut-off switch.

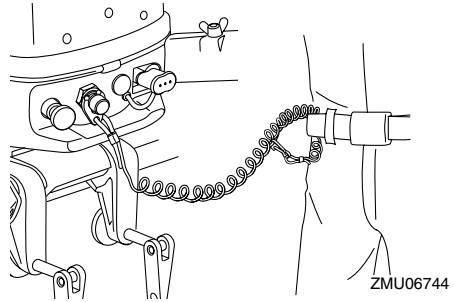

3. Align the engine start mark “⊖” on the throttle grip with the notch in the tiller handle.

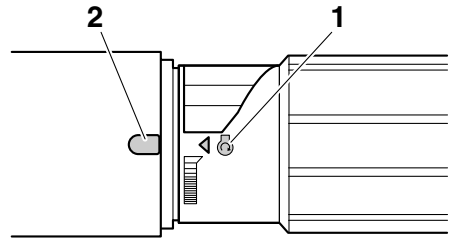

1. Start mark “⊖”
2. Notch

TIP:

If the ambient temperature is -15°C or less, turn the throttle grip so that the engine start mark “⊖” is positioned past the notch in the tiller handle.

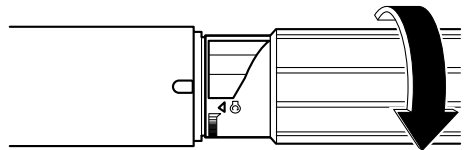

4. Pull out the choke knob fully.

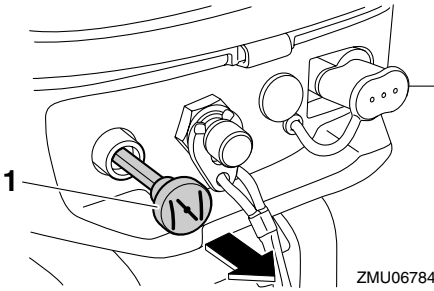

1. Choke knob

TIP:

It is not necessary to use the choke when starting a warm engine, such as immediately after the outboard motor has been operated under a load.

5. Pull the manual starter handle slowly until you feel resistance. Then give a strong pull straight out to crank and start the engine. If the engine does not start on the first try, repeat the procedure.

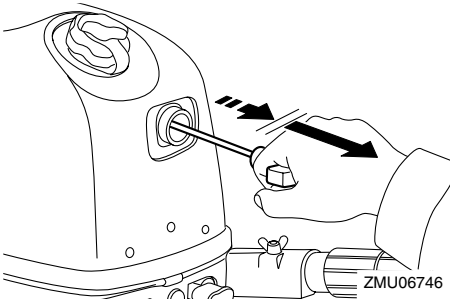

6. After the engine starts, slowly return the manual starter handle to its original position before releasing it.
7. Warm up the engine. For further information, see page 33.
8. Return the choke knob to its original position gradually.
9. Slowly return the throttle grip to the fully closed position.

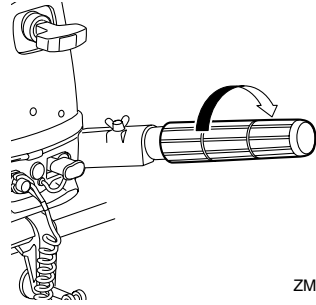

EMU36510

Checks after starting engine

EMU36522

Cooling water

Check for a steady flow of water from the cooling water pilot hole. A continuous flow of water from the pilot hole indicates that the water pump is pumping water through the cooling water passages. If the cooling water passages are frozen, it may take a while for water to start flowing out of the pilot hole.

ECM01810

NOTICE

If water is not flowing out of the pilot hole at all times while the engine is running, overheating and serious damage could occur. Stop the engine and check whether the cooling water inlet on the lower case or the cooling water pilot hole is blocked. Consult your Yamaha dealer if the problem cannot be located and corrected.

Operation

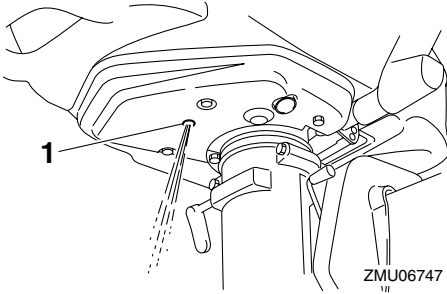

1. Cooling water pilot hole

EMU27670

Warming up engine

EMU40070

Warming up

After starting the engine, return the choke knob to the halfway position. For approximately the first 5 minutes after starting, warm up the engine by operating at one fifth throttle or less. After the engine has warmed up, push the choke knob in fully. Failure to do so will shorten engine life.

TIP:

- If the choke knob is left pulled out after the engine starts, the engine will stall.
- In temperatures of -5°C or less, leave the choke knob pulled out fully for approximately 30 seconds after starting.

EMU36531

Checks after engine warm up

EMU36541

Shifting

While the boat is tightly moored, and without applying throttle, confirm that the engine shifts smoothly into forward and reverse, and back to neutral.

EMU36971

Stop switches

Perform the following procedure to check that the engine stop switch and engine shut-off switch operate properly.

- Start the engine, and then check that the engine stops when the engine stop button is pushed.
- Restart the engine, and then check that the engine stops when the clip is pulled from the engine shut-off switch.
- Check that the engine cannot be started with the clip removed from the engine shut-off switch.

EMU39342

Shifting

EWM00180

WARNING

Before shifting, make sure there are no swimmers or obstacles in the water near you.

ECM02220

NOTICE

Before shifting the outboard motor, turn the throttle grip to the fully closed position and let the engine speed return to idle speed. Otherwise, the shift mechanism could be damaged.

To shift to forward or reverse

Move the gear shift lever to the forward position or reverse position.

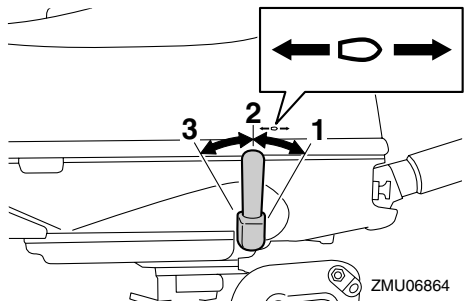

1. Forward position
2. Neutral position
3. Reverse position

To shift to neutral

1. Close the throttle so that the engine slows to idle speed.
2. Move the gear shift lever to the neutral position.

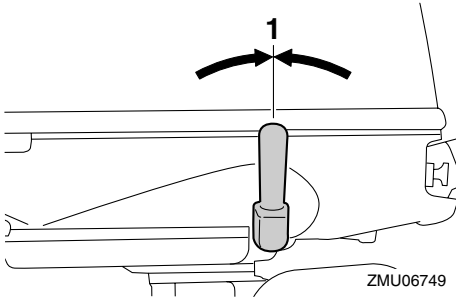

1. Neutral position

EMU39881

Stopping boat

EWM02321

WARNING

Do not use the reverse function to slow down or stop the boat as it could cause you to lose control, be ejected, or impact the load or other parts of the boat. This could increase the risk of serious injury. It could also damage the shift mechanism.

The boat is not equipped with a separate braking system. Water resistance stops it after the throttle lever is moved back to idle. The stopping distance varies depending on gross weight, water surface conditions, and wind direction.

EMU27821

Stopping engine

Before stopping the engine, first let it cool off for a few minutes at idle or low speed. Stopping the engine immediately after operating at high speed is not recommended.

EMU39412

Procedure

1. Push and hold the engine stop button until the engine stops completely. The engine can also be stopped by pulling the engine shut-off cord and removing the clip from the engine shut-off switch.

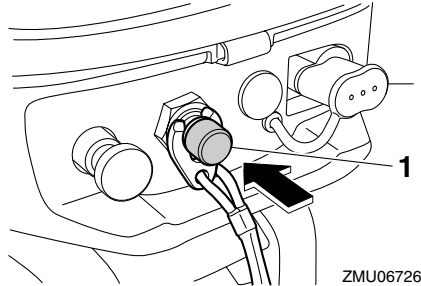

1. Engine stop button

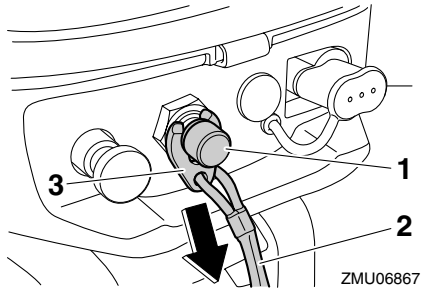

1. Engine shut-off switch
 2. Cord
 3. Clip
2. Tighten the air vent screw on the fuel tank cap.

Operation

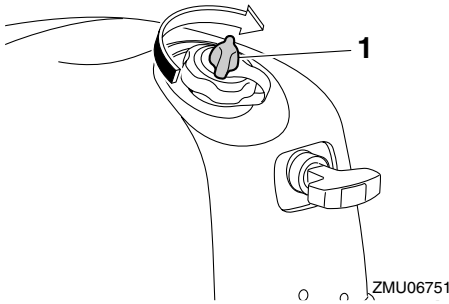

1. Air vent screw

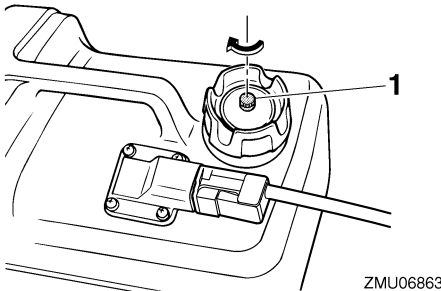

1. Air vent screw
3. Align the fuel cock with the closed position.

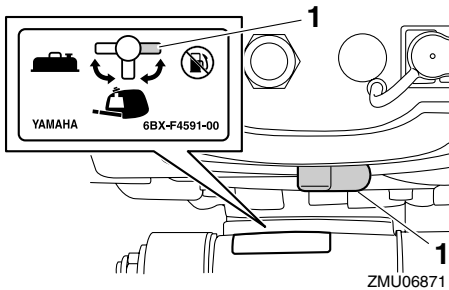

1. Closed position
4. When using a portable fuel tank, disconnect the fuel hose, and then install the fuel joint cap. **WARNING! When not using a portable fuel tank, make sure to**

install the fuel joint cap. Otherwise, injury could result from striking the fuel joint accidentally. [EWM02411]

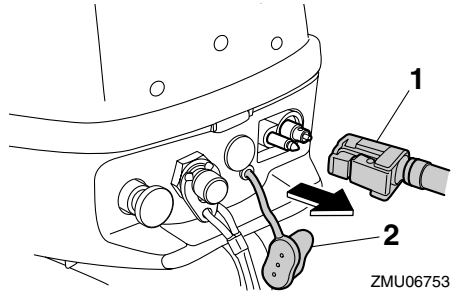

1. Fuel hose
2. Fuel joint cap

EMU40110

Trimming outboard motor

EWM00740

WARNING

Excessive trim for the operating conditions (either trim up or trim down) can cause boat instability and can make steering the boat more difficult. This increases the possibility of an accident. If the boat begins to feel unstable or is hard to steer, slow down and/or readjust the trim angle.

The trim angle of the outboard motor helps determine the position of the bow of the boat in the water. The correct trim angle is affected by variables, such as the load in the boat, sea conditions, and running speed.

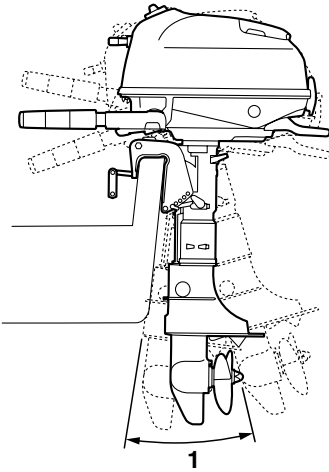

ZMU06754

1. Trim operating angle

EMU39272

Adjusting trim angle for manual tilt models

EW/M00400

! WARNING

- Stop the engine before adjusting the trim angle.
- Use care to avoid being pinched when removing or installing the rod.
- Use caution when trying a trim position for the first time. Increase speed gradually and watch for any signs of instability or control problems. Improper trim angle can cause loss of control.

There are 5 holes provided in the clamp bracket to adjust the outboard motor trim angle.

1. Stop the engine.
2. Tilt the outboard motor up, and then remove the trim rod from the clamp bracket.

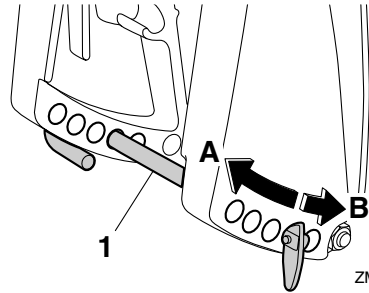

ZMU06755

1. Trim rod

3. Change the position of the trim rod in direction "A" to raise the bow ("trim-out"). Change the position of the trim rod in direction "B" to lower the bow ("trim-in").

TIP:

The outboard motor trim angle changes approximately 4 degrees when the trim rod position is changed by 1 hole.

4. Make test runs with the outboard motor set at different trim angles to find the position that works best for your boat and operating conditions.

EMU40121

Adjusting boat trim

Generally, a boat is stable when the keel line of the boat is up about 3 to 5 degrees. With the bow up, the boat may have a greater tendency to steer to one side or the other. If this occurs, adjust the trim angle.

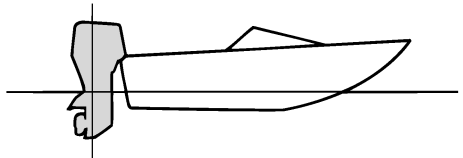

ZMU01784

Operation

Bow Up

Too much trim-out puts the bow of the boat too high in the water. Excessive trim-out can also cause the propeller to ventilate, which reduces performance further, and the boat may “porpoise” (hop in the water), which could throw the operator and passengers overboard.

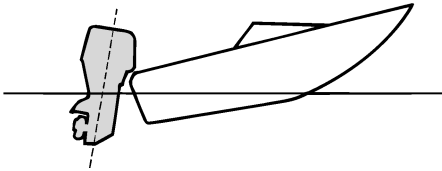

ZMU01785

Bow Down

Too much trim-in causes the boat to “plow” through the water, decreasing fuel economy and making it hard to increase speed. Resistance at the bow is greatly increased, heightening the danger of “bow steering” and making operation difficult and dangerous.

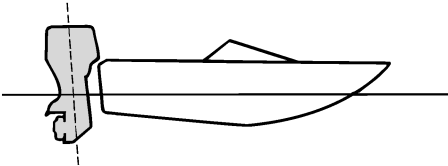

ZMU01786

EMU39592

Tilting up and down

If the engine will be stopped for some time or if the boat is moored in shallows, the outboard motor should be tilted up to protect the propeller and lower case from damage due to collisions with obstructions, and also to reduce salt corrosion.

ler and lower case from damage due to collisions with obstructions, and also to reduce salt corrosion.

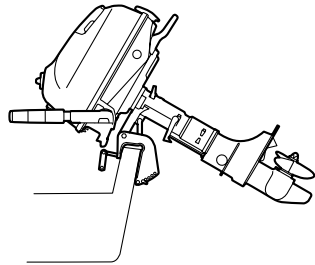

ZMU06840

EWM00222

WARNING

Make sure that no one is near the outboard motor when tilting the outboard motor up or down. Otherwise, body parts could be crushed between the outboard motor and the clamp bracket.

EWM02312

WARNING

Leaking fuel is a fire hazard. When the outboard motor will be tilted up for more than a few minutes, tighten the air vent screw and fuel tank cap and align the fuel cock with the closed position. Otherwise, fuel may leak.

ECM02161

NOTICE

- Before tilting the outboard motor up, follow the procedure under “Stopping engine” in this chapter. Never tilt the outboard motor up while the engine is running. Severe damage from overheating can result.
- Do not tilt the outboard motor up by pushing the tiller handle because this could break the handle.

- The outboard motor cannot be tilted when in reverse.

EMU39552

Procedure for tilting up

1. Align the fuel cock with the closed position.

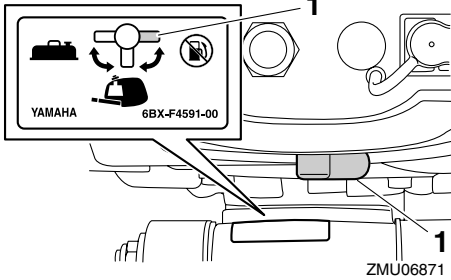

1. Closed position
2. Move the gear shift lever to the neutral position.

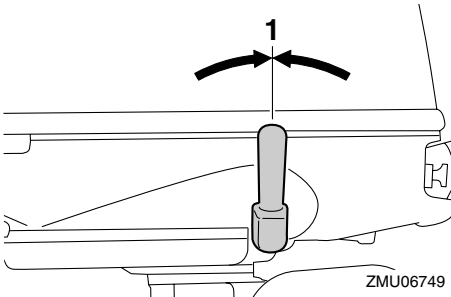

1. Neutral position
3. To prevent steering movement, turn the steering friction adjuster clockwise.

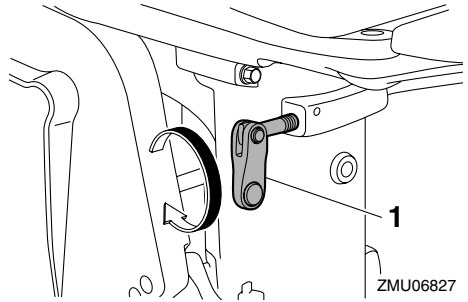

1. Steering friction adjuster

4. Tighten the air vent screw.

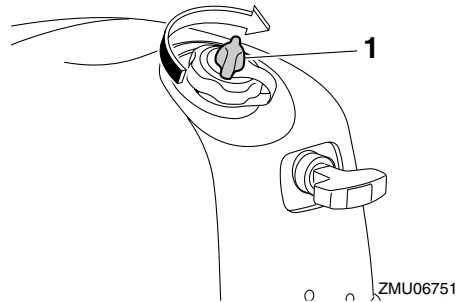

1. Air vent screw

5. When using a portable fuel tank, disconnect the fuel hose, and then install the fuel joint cap. **WARNING! When not using a portable fuel tank, make sure to install the fuel joint cap. Otherwise, injury could result from striking the fuel joint accidentally.** [EWM02411]

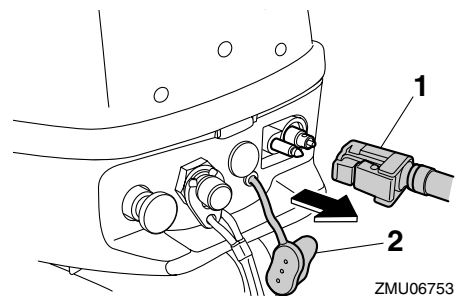

1. Fuel hose

Operation

- Fuel joint cap
- Hold the rear of the top cowling and fully tilt the outboard motor up. Slightly lower the outboard motor from the fully tilted up position and fit the tilt support bar securely into the holder located on the clamp bracket.

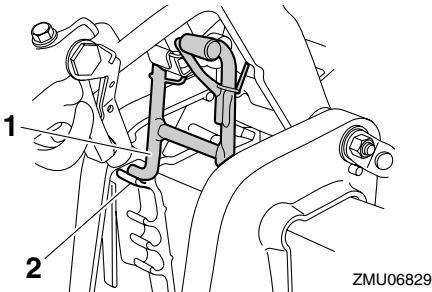

- Tilt support bar
- Holder

EMU39571

Procedure for tilting down

- Slightly tilt the outboard motor up.
- Slowly tilt the outboard motor down while pulling the tilt support bar up.

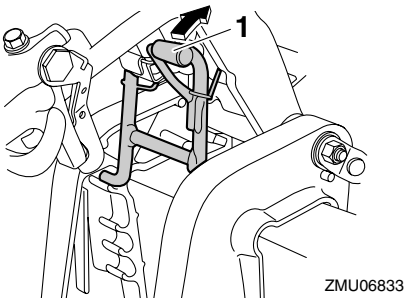

- Tilt support bar
- Turn the steering friction adjuster counterclockwise to set the steering friction according to operator preference.
- WARNING!** If there is too much resis-

tance it could be difficult to steer, which could result in an accident.

[EWM00721]

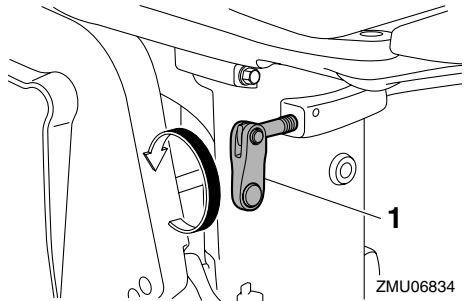

- Steering friction adjuster

EMU28061

Shallow water

EMU39891

Cruising in shallow water

EWM02391

WARNING

- Operate the boat at the lowest possible speed when cruising in shallow water. Hitting an underwater obstacle could cause the outboard motor to lift out of the water, resulting in loss of control.
- When cruising in shallow water, do not operate in reverse. Reverse thrust can cause the outboard motor to lift out of the water, increasing the chance of an accident and personal injury.

ECM00260

NOTICE

Do not tilt the outboard motor up so that the cooling water inlet on the lower unit is above the surface of the water when setting up for and cruising in shallow water. Otherwise severe damage from overheating can result.

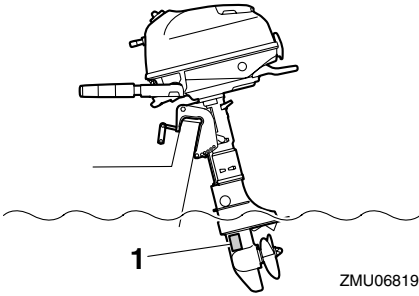

ZMU06819

1. Cooling water inlet

EMU39583

Procedure for shallow water cruising

1. Move the gear shift lever to the neutral position.

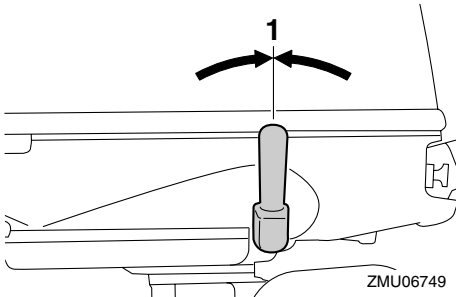

ZMU06749

1. Neutral position
2. Hold the rear of the top cowling and slightly tilt the outboard motor up until the tilt support bar automatically locks. The outboard motor can be operated in this position for shallow water cruising. The outboard motor is equipped with 3 shallow water cruising positions.

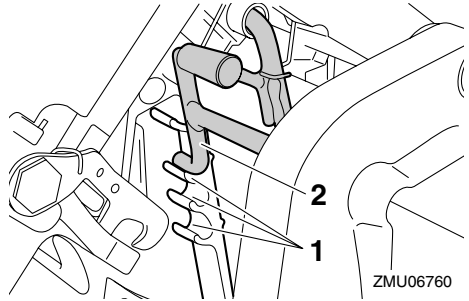

ZMU06760

1. Shallow water cruising position
2. Tilt support bar

EMU40041

Procedure for returning to normal cruising

1. To tilt the outboard motor down to the normal running position, move the gear shift lever to the neutral position.

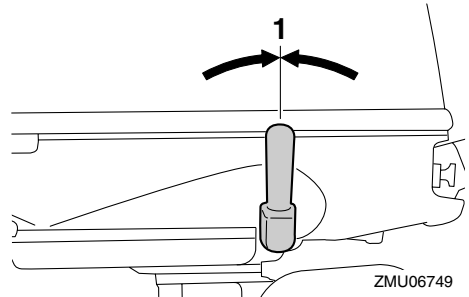

ZMU06749

1. Neutral position
2. Slightly tilt the outboard motor up, and then slowly tilt the outboard motor down while pulling the tilt support bar up.

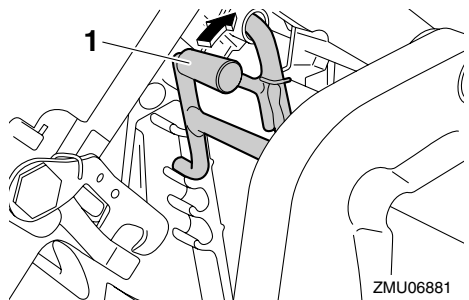

ZMU06881

1. Tilt support bar

Operation

EMU35391

Cruising in other conditions

Cruising in salt water

After operating in salt water, flush the cooling water passages with fresh water to prevent them from becoming clogged. Also rinse the outside of the outboard motor with fresh water.

Cruising in muddy, turbid, or acidic water

Water in some areas can be acidic or with a lot of sediment in it, such as muddy or turbid (cloudy) water. After operating in such water, flush the cooling passages with fresh water to prevent corrosion. Also rinse the outside of the outboard motor with fresh water.

EMU39904

Transporting and storing outboard motor

EWM02630

WARNING

- **USE CARE** when transporting fuel tank, whether in a boat or car.
- **DO NOT** fill fuel container to maximum capacity. Gasoline will expand considerably as it warms up and can build up pressure in the fuel container. This can cause fuel leakage and a potential fire hazard.
- **Leaking fuel is a fire hazard.** When transporting and storing the outboard motor, close the fuel cock to prevent fuel from leaking.
- **Never get under the outboard motor while it is tilted.** Severe injury could occur if the outboard motor accidentally falls.
- **Do not use the tilt support bar when trailering the boat.** The outboard motor could shake loose from the tilt support and fall. If the outboard motor cannot be trailered in the normal running position, use an additional support device to secure it in the tilt position.

ECM02440

NOTICE

When storing the outboard motor for prolonged time, fuel must be drained from the fuel tank. The deteriorated fuel could clog the fuel line causing engine start difficulty or malfunction.

When storing or transporting the outboard motor, make sure to follow the procedure listed below.

- Disconnect the fuel line from the outboard motor.

- Close the fuel cock on the outboard motor, and then tighten the built-in fuel tank cap and its air vent screw.
- Tighten the portable fuel tank cap and its air vent screw.
- When the outboard motor is tilted prolonged time for mooring or trailering the boat, disconnect the fuel line and close the fuel cock on the outboard motor. Tighten the built-in fuel tank cap and its air vent screw. Also tighten the portable fuel tank cap and its air vent screw.

The outboard motor should be transported and stored in the normal running position. If there is insufficient road clearance in this position, then trailer the outboard motor in the tilt position using a motor support device such as a transom saver bar. Consult your Yamaha dealer for further details.

EMU39422

Dismounting the outboard motor

EWM02300

WARNING

Do not hold the top cowling or tiller handle when mounting or dismantling the outboard motor. Otherwise, the outboard motor could fall.

1. Stop the engine and land the boat.
2. Tighten the fuel tank cap and air vent screw securely.

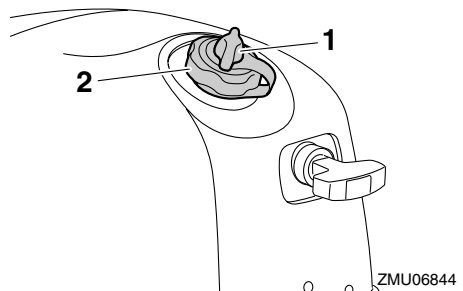

1. Air vent screw
2. Fuel tank cap

Maintenance

- Align the fuel cock with the closed position.

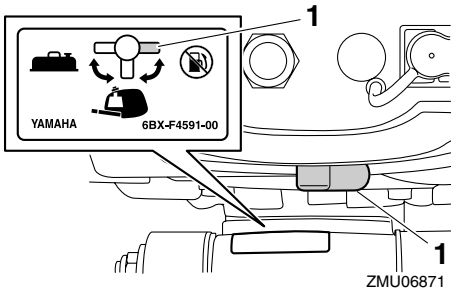

- Closed position
- When using a portable fuel tank, disconnect the fuel hose from the fuel joint, and then install the fuel joint cap. **WARNING! When not using a portable fuel tank, make sure to install the fuel joint cap. Otherwise, injury could result from striking the fuel joint accidentally.**

[EWM02411]

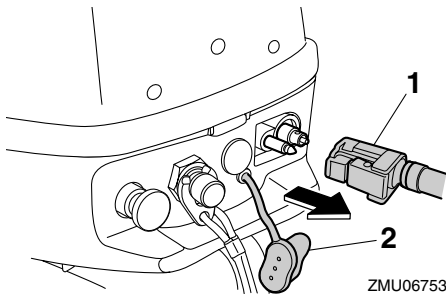

- Fuel hose
- Fuel joint cap
- To prevent steering movement, turn the steering friction adjuster clockwise.

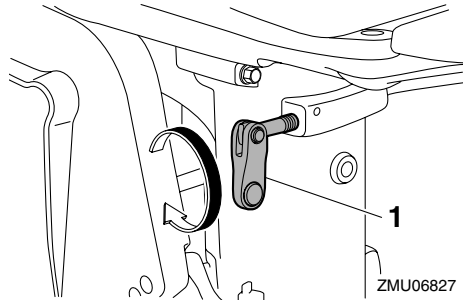

- Steering friction adjuster
- Turn the tiller handle 180° so that it is pointing rearward.

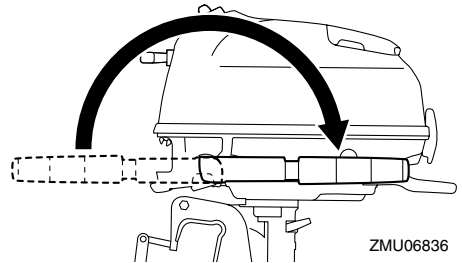

- Loosen the clamp screws.
- Hold the carrying handle and the handgrip on the front side of the bottom cowl and lift up the outboard motor using two people to dismount it from the boat.

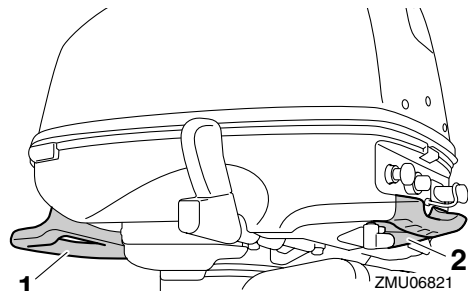

- Carrying handle
- Handgrip

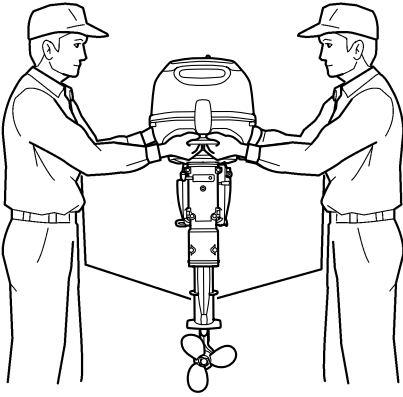

ZMU06835

9. When transporting or storing the outboard motor while removed from a boat, use an outboard motor stand.

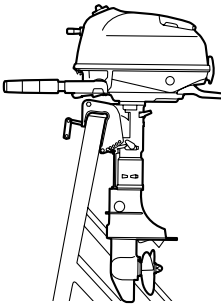

ZMU06761

10. If transporting or storing the outboard motor horizontally cannot be avoided, tighten the clamp screws completely, place a towel or something similar under the outboard motor to protect it from damage, and then place the outboard motor in the attitude shown. If the front side of the outboard motor is facing down, turn the clamp bracket 90° so that it does not contact the ground, and then turn the steering friction adjuster clockwise to secure the bracket.

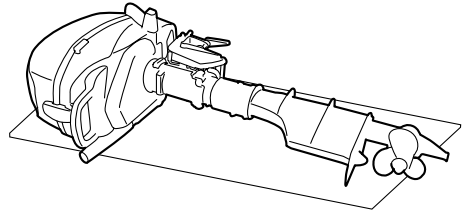

ZMU06806

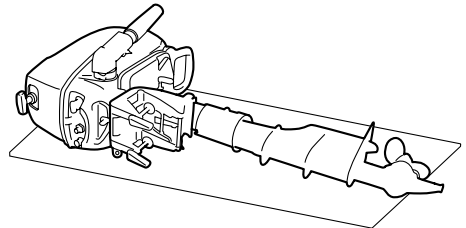

ZMU06762

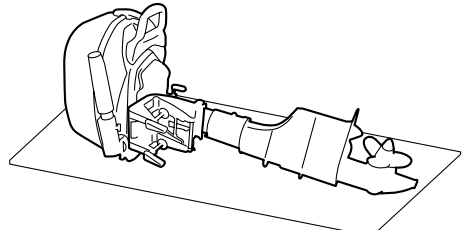

ZMU06807

EMU39912

Storing outboard motor

When storing your Yamaha outboard motor for prolonged periods of time (2 months or longer), several important procedures must be performed to prevent excessive damage. It is advisable to have your outboard motor serviced by an authorized Yamaha dealer prior to storage. However, the following procedures can be performed by the owner.

Maintenance

ECM02212

NOTICE

- Do not place the outboard motor on its side before the cooling water has drained from it completely. Otherwise, water may enter the cylinder through the exhaust valve and cause engine trouble.
- Transport and store the outboard motor as specified in “Dismounting the outboard motor”.
- Store the outboard motor in a dry, well-ventilated place, not in direct sunlight.

EMU28305

Procedure

EMU39612

Flushing in a test tank

ECM00301

NOTICE

Before starting the engine, make sure to supply water to the cooling water passages. Otherwise, the engine could overheat and be damaged.

Cooling system flushing is essential to prevent the cooling system from clogging up with salt, sand, or dirt. In addition, fogging/lubricating of the engine is mandatory to prevent excessive engine damage due to rust. Perform the flushing and fogging at the same time.

1. Wash the outboard motor body using fresh water. **NOTICE: Do not spray water into the air intake.** [ECM01840] For further information, see page 47.
2. When using the built-in fuel tank, completely drain the fuel from the tank, and then align the fuel cock with the closed position and tighten the air vent screw. For draining of the built-in fuel tank, consult a Yamaha dealer.

3. When using a portable fuel tank, disconnect the fuel hose, install the fuel joint cap, and then align the fuel cock with the closed position.

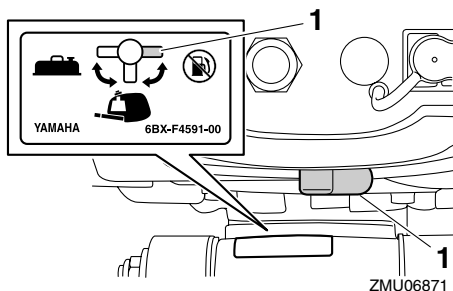

1. Closed position
4. Remove the top cowling and fogging hole cap.

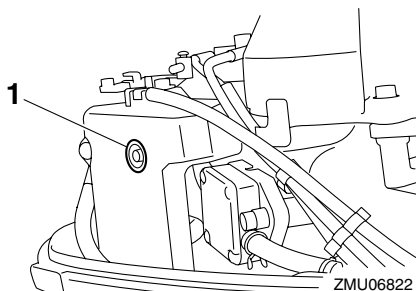

1. Cap
5. Remove the propeller. For further information, see page 56.
6. Install the outboard motor on the test tank.

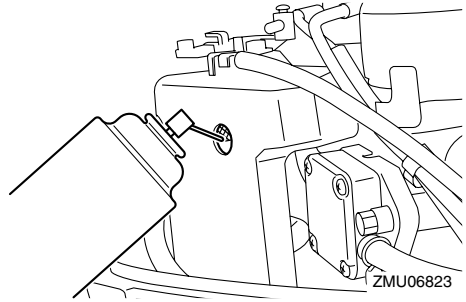
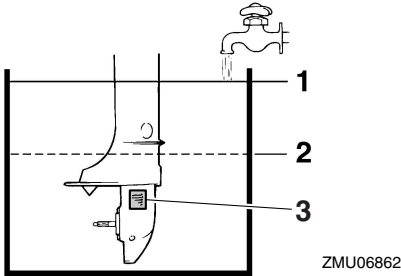

1. Water surface
 2. Lowest water level
 3. Cooling water inlet
7. Fill the test tank with fresh water to above the level of the anti-cavitation plate. **NOTICE: If the fresh water level is below the level of the anti-cavitation plate, or if the water supply is insufficient, engine seizure may occur.**
- [ECM00291]
8. Move the gear shift lever to the neutral position.
 9. Start the engine and run it for a few minutes at engine idle speed. **WARNING! Do not touch or remove electrical parts when starting or during operation. Keep hands, hair, and clothes away from the flywheel and other rotating parts while the engine is running.** [EWM00091]
 10. Before the engine stops, quickly spray “Fogging Oil” into the fogging hole of the silencer. When properly done, the engine will smoke excessively and stop.

11. If “Fogging Oil” is not available, run the engine at engine idle speed until the fuel system empties and the engine stops. Check that the engine has stopped, and then remove the spark plug. Pour a teaspoonful of clean engine oil into the cylinder. Crank several times manually. Install the spark plug.
12. Remove the outboard motor from the test tank.
13. Drain the cooling water completely out of the outboard motor. Clean the body thoroughly.
14. Install the fogging hole cap and top cowling.
15. Install the propeller. For further information, see page 57.

EMU39622

Flushing with the water flush plug (optional)

ECM00301

NOTICE

Before starting the engine, make sure to supply water to the cooling water passages. Otherwise, the engine could overheat and be damaged.

Cooling system flushing is essential to prevent the cooling system from clogging up with salt, sand, or dirt. In addition, fogging/lubricat-

Maintenance

ing of the engine is mandatory to prevent excessive engine damage due to rust. Perform the flushing and fogging at the same time.

1. Wash the outboard motor body using fresh water. **NOTICE: Do not spray water into the air intake.** [ECM01840] For further information, see page 47.
2. Completely drain the fuel from the fuel tank, and then remove the top cowling and fogging hole cap. For further information, see steps 2-4 in “Flushing in a test tank”.
3. Remove the propeller. For further information, see page 56.
4. Remove the screw located beside the “WASH” (wash) mark on the lower case. Install the water flush plug and connect it to a fresh water tap.
5. Cover the cooling water inlet with tape.
6. Turn on the water supply to the outboard motor.

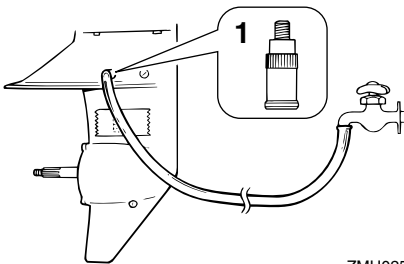

ZMU02509

1. Water flush plug
7. Start the engine, operate it for a few minutes at engine idle speed, and then spray “Fogging Oil” into the fogging hole of the silencer. For further information, see steps 8-11 in “Flushing in a test tank”.
8. Turn off the water supply to the outboard motor, and then remove the water flush plug and tape.

9. Drain the cooling water completely out of the outboard motor. Clean the body thoroughly. Install the fogging hole cap and top cowling.
10. Install the propeller. For further information, see page 57.

EMU39280

Lubrication

1. Install the spark plug and torque to proper specification. For information on spark plug installation, see page 53.
2. Change the gear oil. For instructions, see page 57. Inspect the oil for the presence of water that indicates a leaky seal. Seal replacement should be performed by an authorized Yamaha dealer prior to use.
3. Grease all grease fittings. For further details, see page 52.

TIP:

For long-term storage, fogging the engine with oil is recommended. Contact your Yamaha dealer for information about fogging oil and procedures for your engine.

EMU28451

Cleaning the outboard motor

After use, wash the exterior of the outboard motor with fresh water. Flush the cooling system with fresh water.

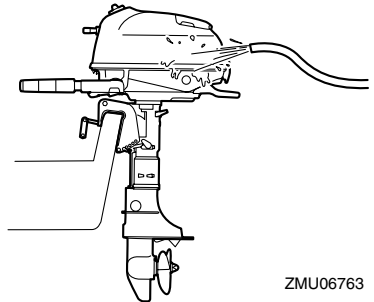

ZMU06763

EMU28461

Checking painted surface of outboard motor

Check the outboard motor for scratches, nicks, or flaking paint. Areas with damaged paint are more likely to corrode. If necessary, clean and paint the areas. A touch-up paint is available from your Yamaha dealer.

EMU37074

Periodic maintenance

EWMO1981



These procedures require mechanical skills, tools, and supplies. If you do not have the proper skills, tools, or supplies to perform a maintenance procedure, have a Yamaha dealer or other qualified mechanic do the work.

The procedures involve disassembling the motor and exposing dangerous parts. To reduce the risk of injury from moving, hot, or electrical parts:

- **Turn off the engine and keep engine shut-off cord (lanyard) with you when you perform maintenance unless otherwise specified.**
- **Allow the engine to cool before handling hot parts or fluids.**
- **Always completely reassemble the motor before operation.**

EMU28511

Replacement parts

If replacement parts are necessary, use only genuine Yamaha parts or parts of equivalent design and quality. Any part of inferior quality may malfunction, and the resulting loss of control could endanger the operator and passengers. Yamaha genuine parts and accessories are available from your Yamaha dealer.

EMU34151

Severe operating conditions

Severe operating conditions involve one or more of the following types of operation on a regular basis:

- Operating continuously at or near maximum engine speed (rpm) for many hours
- Operating continuously at a low engine speed (rpm) for many hours
- Operating without sufficient time for engine to warm up and cool down
- Frequent quick acceleration and deceleration
- Frequent shifting
- Frequently starting and stopping the engine(s)
- Operation that fluctuates often between light and heavy cargo loads

Outboard motors operating under any of these above conditions require more frequent maintenance. Yamaha recommends that you do this service twice as often as specified in the maintenance chart. For example, if a particular service should be done at 50 hours, do it instead at 25 hours. This will help prevent more rapid deterioration of engine components.

Maintenance

EMU34446

Maintenance chart 1

TIP:

- Refer to the sections in this chapter for explanations of each owner-specific action.
- The maintenance cycle on these charts assume usage of 100 hours per year and regular flushing of the cooling water passages. Maintenance frequency should be adjusted when operating the engine under adverse conditions such as extended trolling.
- Disassembly or repairs may be necessary depending on the outcome of maintenance checks.
- Expendable or consumable parts and lubricants will lose their effectiveness over time and through normal usage regardless of the warranty period.
- When operating in salt water, muddy, other turbid (cloudy), acidic water, the engine should be flushed with clean water after each use.

The “●” symbol indicates the check-ups which you may carry out yourself.

The “○” symbol indicates work to be carried out by your Yamaha dealer.

Item	Actions	Initial	Every			
		20 hours (3 months)	100 hours (1 year)	300 hours (3 years)	500 hours (5 years)	
Anode (external)	Inspection or replacement as necessary		●/○			
Anode (thermostat cover)	Inspection or replacement as necessary		○			
Cooling water leakage	Inspection or replacement as necessary	○	○			
Cowling lock lever	Inspection		●/○			
Engine starting condition/noise	Inspection	●/○	●/○			
Engine idle speed/noise	Inspection	○	○			
Engine oil	Replacement	●/○	●/○			
Engine oil filter (crankcase)	Inspection, cleaning or replacement as necessary		○			
Fuel filter (disposal type)	Replacement		○			
Fuel filter (inside built-in fuel tank)	Inspection and cleaning as necessary		○			
Fuel line	Inspection	●	●			
Fuel line	Inspection or replacement as necessary	○	○			
Fuel pump	Inspection or replacement as necessary			○		

Maintenance

Item	Actions	Initial	Every			
		20 hours (3 months)	100 hours (1 year)	300 hours (3 years)	500 hours (5 years)	
Fuel/engine oil leakage	Inspection	○	○			
Gear oil	Replacement	●/○	●/○			
Greasing points	Greasing	●/○	●/○			
Impeller/water pump housing	Inspection or replacement as necessary		○			
Impeller/water pump housing	Replacement			○		
Propeller/propeller nut/cotter pin	Inspection or replacement as necessary	●/○	●/○			
Shift link	Inspection, adjustment or replacement as necessary	○	○			
Spark plug	Inspection or replacement as necessary		●/○			
Spark plug cap/spark plug wire	Inspection or replacement as necessary	○	○			
Water from the cooling water pilot hole	Inspection	●/○	●/○			
Throttle link/throttle cable	Inspection, adjustment or replacement as necessary	○	○			
Thermostat	Inspection or replacement as necessary		○			
Valve clearance	Inspection and adjustment				○	
Cooling water inlet	Inspection	●/○	●/○			
Stop switch	Inspection or replacement as necessary	○	○			
Connector connections/lead connections	Inspection or replacement as necessary	○	○			
Fuel tank (optional Yamaha portable fuel tank)	Inspection and cleaning as necessary		○			
Fuel tank (built-in tank)	Inspection and cleaning as necessary		○			

Maintenance

EMU34451

Maintenance chart 2

Item	Actions	Every
		1000 hours
Exhaust guide/exhaust manifold	Inspection or replacement as necessary	○

EMU28943

Greasing

Yamaha grease A (water resistant grease)

Yamaha grease D (corrosion resistant grease; for propeller shaft)

F4B, F5A, F6C

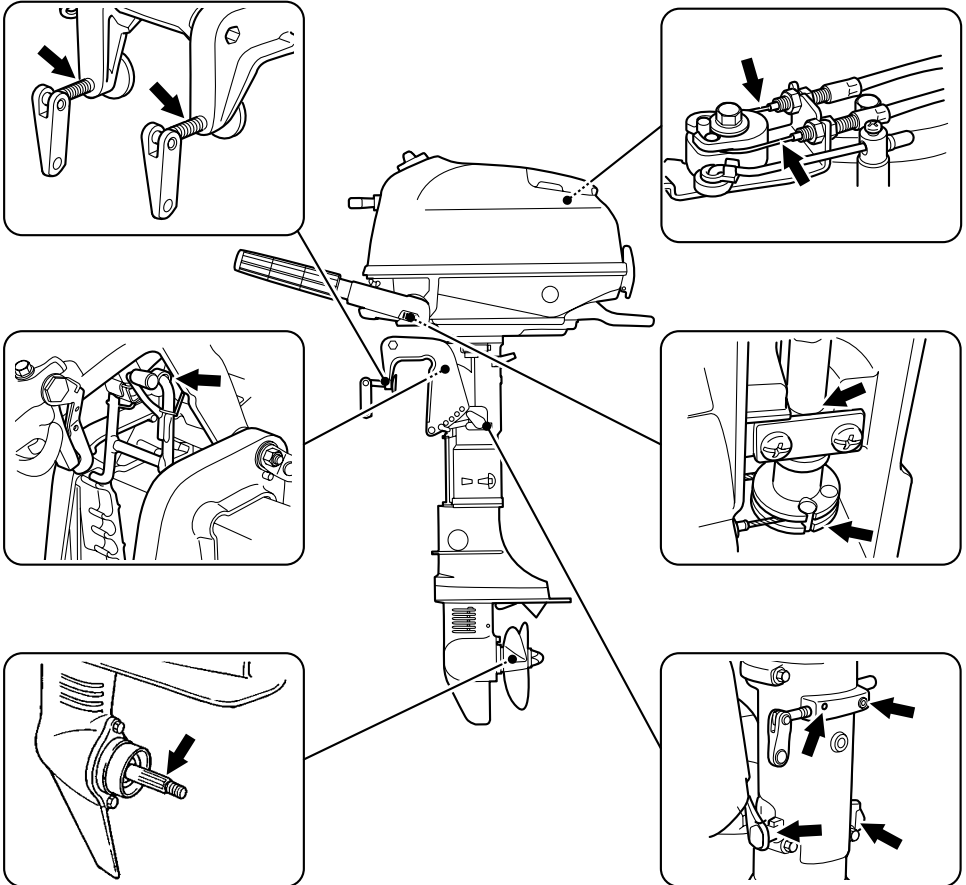

ZMU06764

Maintenance

EMU39291

Cleaning and adjusting spark plug

The spark plug is an important engine component. The condition of the spark plug can indicate something about the condition of the engine. For example, if the center electrode porcelain is very white, this could indicate an intake air leak or carburetion problem in that cylinder. Do not attempt to diagnose any problems yourself. Instead, take the outboard motor to a Yamaha dealer. You should periodically remove and inspect the spark plug because heat and deposits will cause the spark plug to slowly break down and erode.

1. Remove the spark plug cap from the spark plug.

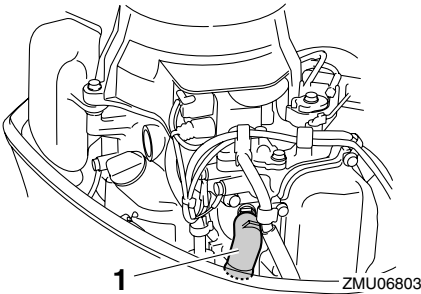

1. Spark plug cap
2. Remove the spark plug. If electrode erosion becomes excessive, or if carbon and other deposits are excessive, you should replace the spark plug with another of the correct type. **WARNING! When removing or installing a spark plug, be careful not to damage the insulator. A damaged insulator could allow external sparks, which could lead to explosion or fire.** [EWM00561]

Standard spark plug:
CR6HSB

3. Be sure to use the specified spark plug, otherwise the engine may not operate properly. Before fitting the spark plug, measure the electrode gap with a wire thickness gauge; replace it if out of specification.

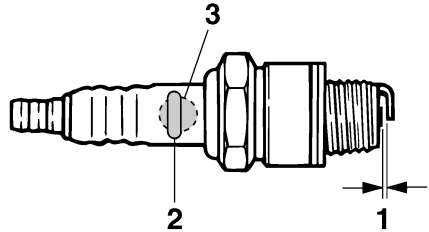

ZMU02179

1. Spark plug gap
2. Spark plug part number
3. Spark plug I.D. mark (NGK)

Spark plug gap:
0.6–0.7 mm (0.024–0.028 in)

4. When fitting the plug, wipe off any dirt from the threads, and then screw it in to the correct torque.

Spark plug torque:
13.0 Nm (1.33 kgf-m, 9.6 ft-lb)

TIP:

If a torque-wrench is not available when you are fitting a spark plug, a good estimate of the correct torque is 1/4 to 1/2 a turn past finger-tight. Have the spark plug adjusted to the correct torque as soon as possible with a torque-wrench.

EMU39920

Checking fuel filter

The fuel filters are located in the filler hole of the built-in fuel tank and in the bottom cowling. Check the fuel filters periodically. If foreign

material is found in the filters, clean or replace them. For cleaning or replacement of the fuel filters, consult a Yamaha dealer.

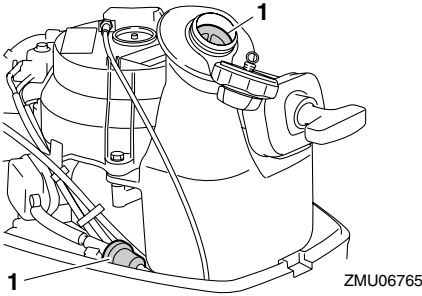

1. Fuel filter

EMU40140

Inspecting idle speed

ECM02230

NOTICE

When checking the engine idle speed, make sure to supply water to the cooling water passages by placing the outboard motor in the water or by using a flushing attachment or test tank.

To check the engine idle speed, a diagnostic tachometer is required. For checking or adjustment of the engine idle speed, consult a Yamaha dealer.

EMU39516

Changing engine oil

ECM01710

NOTICE

Change the engine oil after the first 20 hours of operation or 3 months, and every 100 hours or at 1-year intervals thereafter. Otherwise the engine will wear quickly.

Extract the engine oil with an oil changer.

1. Put the outboard motor in an upright position (not tilted). **NOTICE:** If the outboard motor is not level, the oil level indicated on the oil dipstick may not be accurate. [ECM01861]

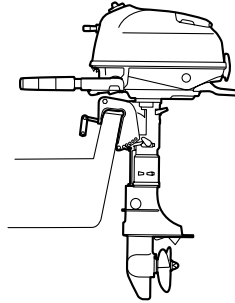

ZMU06766

2. Start the engine. Warm it up and keep the idle speed for 5-10 minutes.
3. Stop the engine and leave it for 5-10 minutes.
4. Remove the top cowling.
5. Remove the oil filler cap.

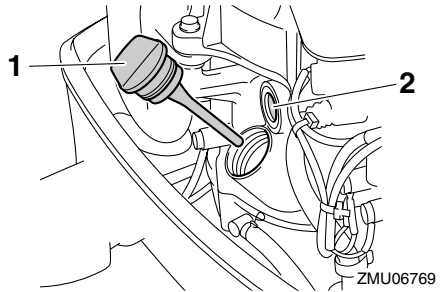

ZMU06769

1. Oil filler cap
2. Oil lubrication check window

TIP:

The oil lubrication check window does not indicate the engine oil level. Use the oil lubrication check window to make sure that the engine is being lubricated with oil while it is running.

6. Insert the tube of the oil changer into the oil filler hole, and then extract the engine oil completely using the oil changer.

Maintenance

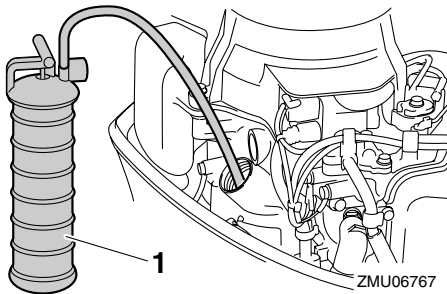

1. Oil changer

7. If the oil changer is not available, remove the drain screw while holding a container under the drain hole. Let the oil drain completely. Wipe up any spilled oil immediately.

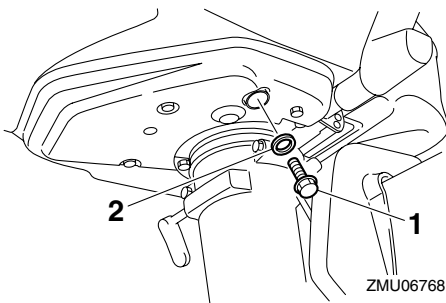

1. Drain screw
2. Washer

8. If the drain screw was removed, install a new washer and drain screw, and then tighten the drain screw.

Engine oil drain bolt:
18.0 Nm (1.84 kgf-m, 13.3 ft-lb)

9. Add the correct amount of oil through the filler hole. **NOTICE: Overfilling the oil tank could cause leakage or damage. If the oil level is above the upper mark, extract oil until the oil is between the upper and lower marks.** [ECM02181]

10. Install the oil filler cap and tighten it completely.

Recommended engine oil:
4-stroke outboard motor oil
Engine oil quantity:
0.6 L (0.63 US qt, 0.53 Imp.qt)

11. Leave the outboard motor for 5-10 minutes.
12. Remove the oil filler cap and wipe the attached oil dipstick clean.
13. Install the oil filler cap and tighten it completely.
14. Remove the oil filler cap again and check that the oil level on the dipstick is between the upper and lower marks. If the oil level is not at the proper level, add or extract oil until the oil is between the upper and lower marks.

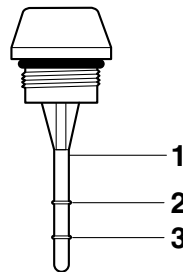

1. Oil dipstick
2. Upper mark
3. Lower mark

15. Start the engine and make sure that there are no oil leaks. **NOTICE: If there are oil leaks, stop the engine and find the cause. Consult your Yamaha dealer if the problem cannot be located and corrected. Continued operation with a problem could cause severe engine damage.** [ECM02150]

16. Dispose of used oil according to local regulations.

TIP:

- For more information on the disposal of used oil, consult your Yamaha dealer.
- Change the oil more often when operating the engine under adverse conditions such as extended trolling.

17. Install the top cowling.

EMU39771

Checking connector and lead

For checking of the following items for the connectors and leads, consult a Yamaha dealer.

- Check that each connector is connected securely.
- Check that each ground lead is secured properly.

EMU39301

Checking propeller

EWM02280

WARNING

You could be seriously injured if the engine accidentally starts when you are near the propeller. Before inspecting, removing, or installing the propeller, place the gear shift lever in neutral, and remove the clip from the engine shut-off switch.

Do not use your hand to hold the propeller when loosening or tightening the propeller nut. Put a wood block between the anti-cavitation plate and the propeller to prevent the propeller from turning.

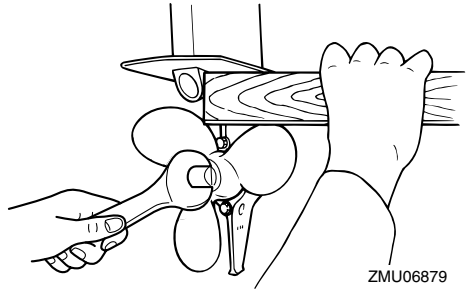

Checkpoints

- Check each of the propeller blades for erosion from cavitation or ventilation, or other damage.
- Check the propeller shaft for damage.
- Check the splines for wear or damage.
- Check for fish line tangled around the propeller shaft.
- Check the propeller shaft oil seal for damage.

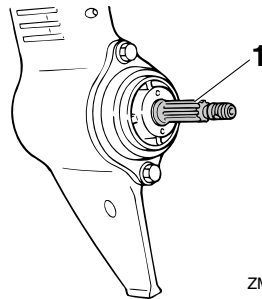

1. Propeller shaft

EMU30662

Removing propeller

EMU39310

Spline models

1. Straighten the cotter pin and pull it out using a pair of pliers.
2. Remove the propeller nut and washer.
WARNING! Do not use your hand to hold the propeller when loosening the propeller nut. [EWM01890]

Maintenance

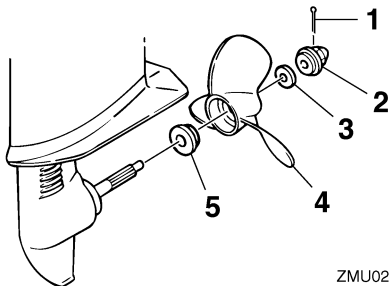

ZMU02184

1. Cotter pin
2. Propeller nut
3. Washer
4. Propeller
5. Thrust washer

3. Remove the propeller and thrust washer.

EMU30672

Installing propeller

EMU39323

Spline models

ECM00501

NOTICE

Make sure to use a new cotter pin and bend the ends over securely. Otherwise, the propeller could come off during operation and be lost.

1. Apply Yamaha grease D (corrosion resistant grease) into the propeller shaft.
2. Install the thrust washer and propeller onto the propeller shaft. **NOTICE: Make sure to install the thrust washer before installing the propeller. Otherwise, the lower case and propeller boss could be damaged.** [ECM01881]
3. Install the washer and tighten the propeller nut until there is no looseness in the propeller.
4. Align the propeller nut hole with the propeller shaft hole. Insert a new cotter pin in the holes and bend the cotter pin ends.

NOTICE: Do not reuse the cotter pin. Otherwise, the propeller can come off during operation. [ECM01891]

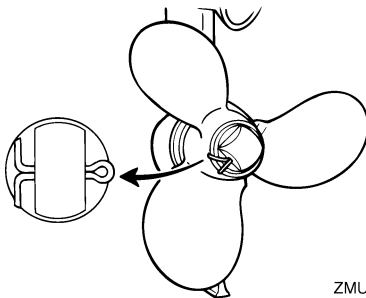

ZMU02185

TIP:

If the propeller nut hole does not align with the propeller shaft hole after tightening the propeller nut, tighten the nut further or loosen the nut to align the holes.

EMU39781

Changing gear oil

EWMO2350

WARNING

Be sure the outboard motor is securely fastened to the transom or a stable stand. You could be severely injured if the outboard motor falls on you.

1. Put the outboard motor in an upright position (not tilted).
2. Place a suitable container under the gear case.
3. Remove the gear oil drain screw and gasket.

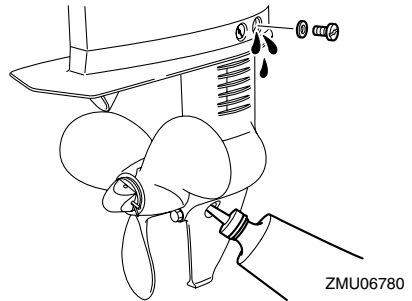
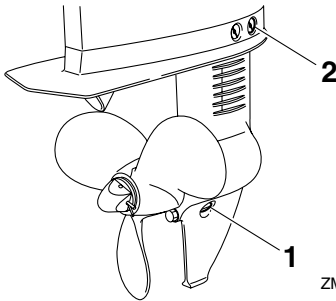

1. Gear oil drain screw
 2. Oil level plug
4. Remove the oil level plug and gasket to allow the oil to drain completely.
NOTICE: Check the used gear oil after it has been drained. If the gear oil is milky or contains water or a large amount of metal particles, the gear case may be damaged. Have a Yamaha dealer check and repair the outboard motor. [ECM00713]

TIP:

For disposal of used oil, consult your Yamaha dealer.

5. Using a flexible or pressurized filling device, inject the gear oil into the gear oil drain screw hole.

Recommended gear oil:
Hypoid gear oil SAE#90
Gear oil quantity:
0.100 L (0.106 US qt, 0.088 Imp.qt)

6. Put a new gasket on the oil level plug. When the oil begins to flow out of the oil level plug hole, insert and tighten the oil level plug.

Tightening torque:
9.0 Nm (0.92 kgf-m, 6.6 ft-lb)

7. Put a new gasket on the gear oil drain screw. Insert and tighten the gear oil drain screw.

Tightening torque:
9.0 Nm (0.92 kgf-m, 6.6 ft-lb)

EMU39331

Inspecting and replacing anode (external)

Yamaha outboard motors are protected from corrosion by sacrificial anode. Inspect the external anode periodically. Remove scales from the surface of the anode. Consult a Yamaha dealer for replacement of the external anode.

ECM00720

NOTICE

Do not paint anodes, as this would render them ineffective.

Maintenance

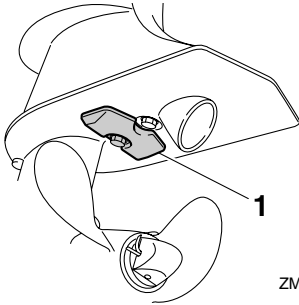

ZMU06781

1. Anode

EMU39523

Troubleshooting

This section describes the likely causes and remedies for problems, such as those in the fuel, compression, and ignition systems, poor starting, and loss of power. Please note that all of the items in this section may not apply to your model.

If your outboard motor requires repair, bring it to a Yamaha dealer.

Engine will not start.

Q. Is fuel tank empty?

A. Fill tank with clean, fresh fuel.

Q. Is fuel contaminated or stale?

A. Fill tank with clean, fresh fuel.

Q. Is fuel filter clogged?

A. Clean or replace filter.

Q. Is fuel pump malfunctioning?

A. Have serviced by a Yamaha dealer.

Q. Is spark plug fouled or of incorrect type?

A. Inspect spark plug. Clean or replace with recommended type.

Q. Is spark plug cap fitted incorrectly?

A. Check and re-fit cap.

Q. Is spark plug wiring damaged or poorly connected?

A. Check wires for wear or breaks. Tighten all loose connections. Replace worn or broken wires.

Q. Are electrical parts malfunctioning?

A. Have serviced by a Yamaha dealer.

Q. Is clip on engine shut-off cord (lanyard) installed?

A. Install clip to engine shut-off switch.

Q. Are engine inner parts damaged?

A. Have serviced by a Yamaha dealer.

Engine idles irregularly or stalls.

Q. Is fuel system obstructed?

A. Check for pinched or kinked fuel line or other obstructions in fuel system.

Q. Is fuel contaminated or stale?

A. Fill tank with clean, fresh fuel.

Q. Is fuel filter clogged?

A. Clean or replace filter.

Q. Are electrical parts malfunctioning?

A. Have serviced by a Yamaha dealer.

Q. Is spark plug gap incorrect?

A. Replace spark plug.

Q. Is spark plug wiring damaged or poorly connected?

A. Check wires for wear or breaks. Tighten all loose connections. Replace worn or broken wires.

Q. Is specified engine oil not being used?

A. Check and replace oil with specified type.

Q. Is thermostat malfunctioning or clogged?

A. Have serviced by a Yamaha dealer.

Q. Are carburetor adjustments incorrect?

A. Have serviced by a Yamaha dealer.

Q. Is fuel pump malfunctioning?

A. Have serviced by a Yamaha dealer.

Q. Is air vent screw tightened?

Trouble Recovery

A. Loosen air vent screw.

Q. Is choke knob pulled out?

A. Return to home position.

Q. Is carburetor clogged?

A. Have serviced by a Yamaha dealer.

Q. Is fuel joint connection incorrect?

A. Connect correctly.

Q. Is throttle cable adjustment incorrect?

A. Have serviced by a Yamaha dealer.

Engine power loss.

Q. Is propeller damaged?

A. Have propeller repaired or replaced.

Q. Is propeller pitch or diameter incorrect?

A. Install correct propeller to operate outboard at its recommended speed (r/min) range.

Q. Is trim angle incorrect?

A. Adjust trim angle to achieve most efficient operation.

Q. Is outboard motor mounted at incorrect height on transom?

A. Have outboard motor adjusted to proper transom height.

Q. Is boat bottom fouled with marine growth?

A. Clean boat bottom.

Q. Is spark plug fouled or of incorrect type?

A. Inspect spark plug. Clean or replace with recommended type.

Q. Are weeds or other foreign material tangled on gear housing?

A. Remove foreign material and clean lower unit.

Q. Is fuel system obstructed?

A. Check for pinched or kinked fuel line or other obstructions in fuel system.

Q. Is fuel filter clogged?

A. Clean or replace filter.

Q. Is fuel contaminated or stale?

A. Fill tank with clean, fresh fuel.

Q. Is spark plug gap incorrect?

A. Replace spark plug.

Q. Is spark plug wiring damaged or poorly connected?

A. Check wires for wear or breaks. Tighten all loose connections. Replace worn or broken wires.

Q. Are electrical parts malfunctioning?

A. Have serviced by a Yamaha dealer.

Q. Is specified fuel not being used?

A. Replace fuel with specified type.

Q. Is specified engine oil not being used?

A. Check and replace oil with specified type.

Q. Is thermostat malfunctioning or clogged?

A. Have serviced by a Yamaha dealer.

Q. Is air vent screw tightened?

A. Loosen air vent screw.

Q. Is fuel pump malfunctioning?

A. Have serviced by a Yamaha dealer.

Q. Is fuel joint connection incorrect?

A. Connect correctly.

Engine vibrates excessively.

Q. Is propeller damaged?

A. Have propeller repaired or replaced.

Q. Is propeller shaft damaged?

A. Have serviced by a Yamaha dealer.

Q. Are weeds or other foreign material tangled on propeller?

A. Remove and clean propeller.

Q. Is steering pivot loose or damaged?

A. Have serviced by a Yamaha dealer.

EMU29433

Temporary action in emergency

EMU29441

Impact damage

EWM00870

WARNING

The outboard motor can be seriously damaged by a collision while operating or trailering. Damage could make the outboard motor unsafe to operate.

If the outboard motor hits an object in the water, follow the procedure below.

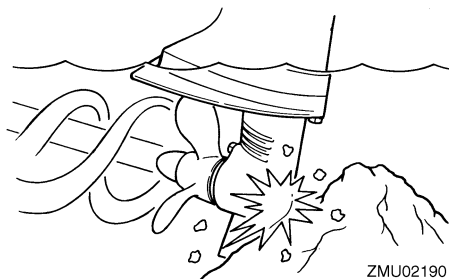

1. Stop the engine immediately.
2. Check the control system and all components for damage. Also, check the boat for damage.

3. Whether damage is found or not, return to the nearest harbor slowly and carefully.

4. Have a Yamaha dealer check the outboard motor before operating it again.

EMU39791

Starter will not operate

If the starter mechanism does not operate (the engine cannot be cranked with the starter), the engine can be started with an emergency starter rope.

EWM02361

WARNING

- Use this procedure only for emergency engine starting to return to the nearest port for repairs.
- When the emergency starter rope is used to start the engine, the start-in-gear protection device does not operate. Make sure that the shift lever is in the neutral position. Otherwise, the boat could unexpectedly start to move, which could result in an accident.
- Attach the engine shut-off cord to a secure place on your clothing, or your arm or leg while operating the boat.
- Do not attach the cord to clothing that could tear loose. Do not route the cord where it could become entangled, preventing it from functioning.
- Avoid accidentally pulling the cord during normal operation. Loss of engine power means the loss of most steering control. Also, without engine power, the boat could slow rapidly. This could cause people and objects in the boat to be thrown forward.
- Make sure that no one is standing behind you when pulling the starter rope. It could whip behind you and injure someone.

Trouble Recovery

- An unguarded, rotating flywheel is very dangerous. Keep loose clothing and other objects away when starting the engine. Use the emergency starter rope only as instructed. Do not touch the flywheel or other moving parts when the engine is running. Do not install the starter mechanism or top cowling after the engine is running.
- Do not touch the ignition coil, spark plug wire, spark plug cap, or other electrical components when starting or operating the outboard motor. You could get an electrical shock.

EMU39533

Emergency engine starting

Before performing the following procedure, make sure to read the emergency starting label on the manual starter/flywheel magnet cover.

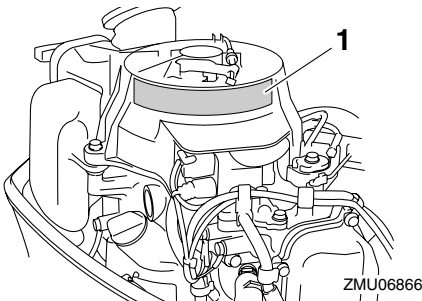

1. Emergency starting label
1. Move the gear shift lever to the neutral position.

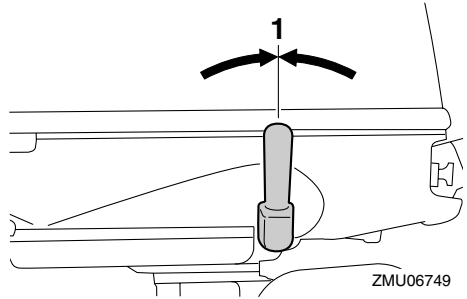

1. Neutral position
2. Remove the top cowling.
3. Loosen the nut, and then disconnect the start-in-gear protection cable.

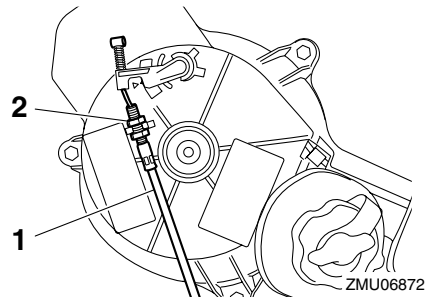

1. Start-in-gear protection cable
2. Nut
4. Remove the manual starter/flywheel magnet cover by removing the bolts.

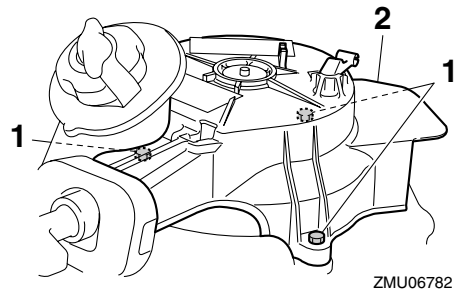

1. Bolts
2. Manual starter/flywheel magnet cover
5. Reinstall 2 bolts to secure the fuel tank.

Trouble Recovery

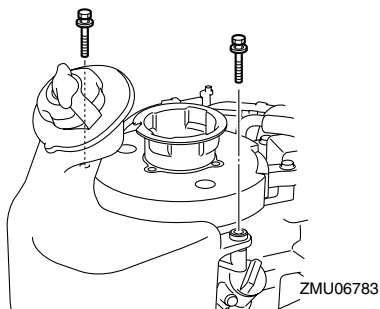

6. Insert the knotted end of the emergency starter rope into the notch in the flywheel magnet and wind the rope several turns around the flywheel magnet clockwise.

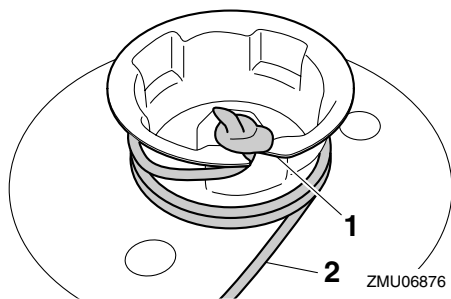

1. Notch
2. Emergency starter rope

7. Attach the engine shut-off cord to a secure place on your clothing, or your arm or leg. Then, install the clip on the other end of the cord to the engine shut-off switch.

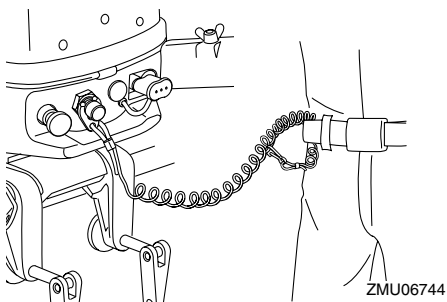

8. Align the engine start mark "⊙" on the throttle grip with the notch in the tiller handle.

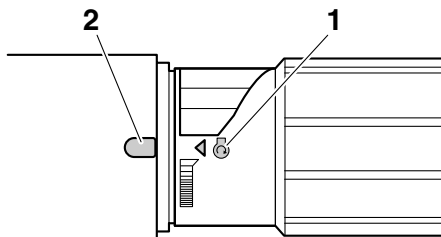

1. Start mark "⊙"
2. Notch

9. Give a strong pull straight out to crank and start the engine.

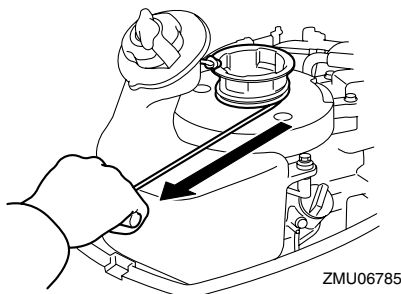

TIP:

If the engine does not start after several attempts, pull out the choke knob.

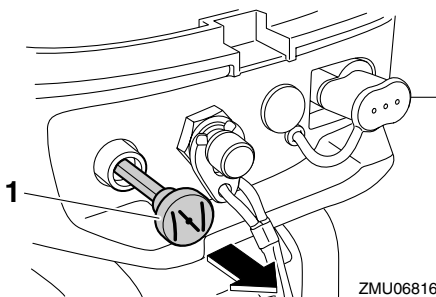

1. Choke knob

Trouble Recovery

EMU33501

Treatment of submerged motor

If the outboard motor is submerged, immediately take it to a Yamaha dealer. Otherwise some corrosion may begin almost immediately. **NOTICE: Do not attempt to run the outboard motor until it has been completely inspected.** [ECM00401]



YAMAHA MOTOR CO., LTD.

Printed in France

April 2010-0.3 × 1 CR