



YAMAHA



5C

OWNER'S MANUAL

6A1-28199-7R-E0

Read this owner's manual carefully before operating your outboard motor.

Important manual information

EMU25101

To the owner

Thank you for choosing a Yamaha outboard motor. This Owner's Manual contains information needed for proper operation, maintenance and care. A thorough understanding of these simple instructions will help you obtain maximum enjoyment from your new Yamaha. If you have any question about the operation or maintenance of your outboard motor, please consult a Yamaha dealer.

In this Owner's Manual particularly important information is distinguished in the following ways.



The Safety Alert Symbol means ATTENTION! BECOME ALERT! YOUR SAFETY IS INVOLVED!

EWM00780



WARNING

Failure to follow WARNING instructions could result in severe injury or death to the machine operator, a bystander, or a person inspecting or repairing the outboard motor.

ECM00700

CAUTION:

A CAUTION indicates special precautions that must be taken to avoid damage to the outboard motor.

NOTE:

A NOTE provides key information to make procedures easier or clearer.

Yamaha continually seeks advancements in product design and quality. Therefore, while this manual contains the most current product information available at the time of printing, there may be minor discrepancies between

your machine and this manual. If there is any question concerning this manual, please consult your Yamaha dealer.

To ensure long product life, Yamaha recommends that you use the product and perform the specified periodic inspections and maintenance by correctly following the instructions in the owner's manual. Note that if you do not follow these instructions, not only may the product break down, but the warranty will also be voided.

Some countries have laws or regulations restricting users from taking the product out of the country where it was purchased, and it may be impossible to register the product in the destination country. Additionally, the warranty may not apply in certain regions. When planning to take the product to another country, consult the dealer where the product was purchased for further information.

If the product was purchased used, please consult your closest dealer for customer re-registration, and to be eligible for the specified services.

NOTE:

The 5CMH and the standard accessories are used as a base for the explanations and illustrations in this manual. Therefore some items may not apply to every model.

EMU25120

5C

OWNER'S MANUAL

©2006 by Yamaha Motor Co., Ltd.

1st Edition, February 2006

All rights reserved.

Any reprinting or unauthorized use without the written permission of Yamaha Motor Co., Ltd.

is expressly prohibited.

Printed in Japan

Table of contents

General information	1	Breaking in engine	14
Identification numbers record	1	Gasoline and engine oil mixing	
Outboard motor serial number	1	chart (50:1).....	14
EC label.....	1	Procedure for pre-mixed models	14
Safety information	1	Preoperation checks	15
Important labels.....	3	Fuel	15
Warning labels.....	3	Oil	15
Fueling instructions	3	Controls	15
Gasoline	4	Engine	15
Engine oil.....	4	Filling fuel and engine oil	15
Propeller selection.....	4	Filling fuel for portable tank	15
Start-in-gear protection	4	Filling fuel for built-in tank.....	15
		Gasoline and oil mixing (100:1).....	16
Basic components	6	Operating engine	17
Main components.....	6	Feeding fuel (portable tank)	17
Fuel tank.....	6	Feeding fuel.....	18
Fuel tank.....	7	Starting engine	19
Fuel joint.....	7	Warming up engine.....	21
Fuel gauge	7	Choke start models	21
Fuel tank cap.....	7	Shifting	21
Air vent screw.....	7	Forward (tiller handle and remote	
Fuel cock.....	7	control models)	21
Open.....	8	Reverse	22
Tiller handle.....	8	Stopping engine.....	22
Gear shift lever	8	Procedure	22
Throttle grip	8	Trimming outboard motor.....	23
Throttle indicator.....	8	Adjusting trim angle for manual tilt	
Throttle friction adjuster.....	9	models	23
Engine stop lanyard switch.....	9	Adjusting boat trim.....	24
Engine stop button	10	Tilting up and down.....	25
Choke knob	10	Procedure for tilting up (manual tilt	
Manual starter handle.....	10	models)	25
Steering friction adjuster.....	10	Procedure for tilting down	
Trim rod (tilt pin)	10	(manual tilt models).....	26
Tilt support bar	11	Cruising in shallow water	27
Top cowling lock lever(s)		Cruising in shallow water	
(turn type).....	11	(manual tilt models).....	27
Operation	12		
Installation	12		
Mounting the outboard motor	12		
Clamping the outboard motor.....	13		

Table of contents

Cruising in other conditions	28	Treatment of submerged	
Maintenance.....	29	motor.....	47
Specifications	29	Procedure.....	47
Transporting and storing			
outboard motor.....	30		
Clamp screw mounting models	30		
Storing outboard motor.....	30		
Procedure.....	31		
Lubrication			
(except oil injection models).....	32		
Cleaning the outboard motor.....	32		
Checking painted surface of			
motor.....	32		
Periodic maintenance.....	32		
Replacement parts	32		
Maintenance chart.....	33		
Greasing.....	34		
Cleaning and adjusting			
spark plug	34		
Checking fuel system	35		
Checking fuel filter.....	36		
Inspecting idling speed.....	36		
Checking wiring and connectors	36		
Exhaust leakage.....	37		
Water leakage	37		
Checking propeller	37		
Removing the propeller	38		
Installing the Propeller.....	38		
Changing gear oil	38		
Cleaning fuel tank.....	39		
Inspecting and replacing			
anode(s).....	40		
Checking top cowling	40		
Coating the boat bottom.....	40		
Trouble Recovery	42		
Troubleshooting	42		
Temporary action in			
emergency	45		
Impact damage.....	45		
Starter will not operate	45		
Emergency starting engine.....	46		

General information

EMU25170

Identification numbers record

EMU25183

Outboard motor serial number

The outboard motor serial number is stamped on the label attached to the port side of the clamp bracket.

Record your outboard motor serial number in the spaces provided to assist you in ordering spare parts from your Yamaha dealer or for reference in case your outboard motor is stolen.

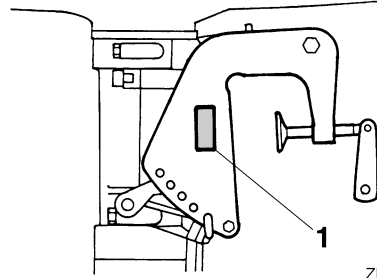

ZMU02759

1. EC label location

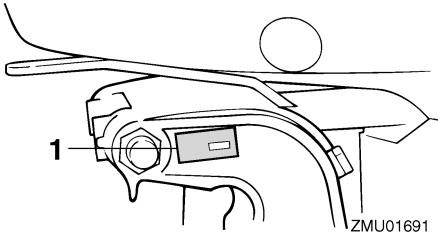

ZMU01691

1. Outboard motor serial number location

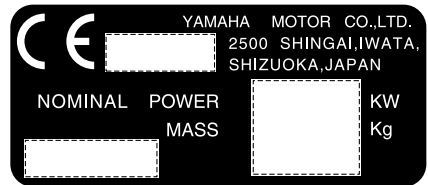

ZMU01696

EMU25371

Safety information

- Before mounting or operating the outboard motor, read this entire manual. Reading it should give you an understanding of the motor and its operation.
- Before operating the boat, read any owner's or operator's manuals supplied with it and all labels. Be sure you understand each item before operating.
- Do not overpower the boat with this outboard motor. Overpowering the boat could result in loss of control. The rated power of the outboard should be equal to or less than the rated horsepower capacity of the boat. If the rated horsepower capacity of the boat is unknown, consult the dealer or boat manufacturer.

EMU25202

EC label

Engines affixed with this label conform to certain portions of the European Parliament directive relating to machinery. Refer to the label and the EC Declaration of Conformity for more details.

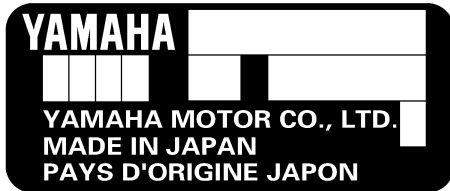

ZMU01692

General information

- Do not modify the outboard. Modifications could make the motor unfit or unsafe to use.
- Incorrect propeller selection and incorrect use may not only cause engine damage, but also adversely affect fuel consumption. Consult your dealer for correct use.
- Never operate after drinking alcohol or taking drugs. About 50% of all boating fatalities involve intoxication.
- Have an approved personal flotation device (PFD) on board for every occupant. It is a good idea to wear a PFD whenever boating. At a minimum, children and non-swimmers should always wear PFDs, and everyone should wear PFDs when there are potentially hazardous boating conditions.
- Gasoline is highly flammable, and its vapors are flammable and explosive. Handle and store gasoline carefully. Make sure there are no gas fumes or leaking fuel before starting the engine.
- This product emits exhaust gases which contain carbon monoxide, a colorless, odorless gas which may cause brain damage or death when inhaled. Symptoms include nausea, dizziness, and drowsiness. Keep cockpit and cabin areas well ventilated. Avoid blocking exhaust outlets.
- Check throttle, shift, and steering for proper operation before starting the engine.
- Attach the engine stop switch lanyard to a secure place on your clothing, or your arm or leg while operating. If you accidentally leave the helm, the lanyard will pull from the switch, stopping the engine.
- Know the marine laws and regulations where you will be boating - and obey them.
- Stay informed about the weather. Check weather forecasts before boating. Avoid boating in hazardous weather.
- Tell someone where you are going: leave a Float Plan with a responsible person. Be sure to cancel the Float Plan when you return.
- Use common sense and good judgment when boating. Know your abilities, and be sure you understand how your boat handles under the different boating conditions you may encounter. Operate within your limits, and the limits of your boat. Always operate at safe speeds, and keep a careful watch for obstacles and other traffic.
- Always watch carefully for swimmers during the engine operation.
- Stay away from swimming areas.
- When a swimmer is in the water near you shift into neutral and shut off the engine.
- Do not illegally discard empty containers used to replace or replenish oil. For the correct processing of empty containers, consult the dealer where you purchased the oil.
- When replacing oils used to lubricate the product (engine or gear oil), be sure to wipe away any spilt oil. Never pour oil without using a funnel or similar device. If necessary, verify the necessary replacement procedure with the dealer.
- Never illegally discard (dump) the product. Yamaha recommends consulting the dealer on discarding the product.

General information

EMU25382

Important labels

EMU25395

Warning labels

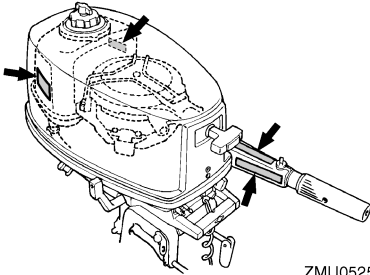

ZMU05258

EMU25401

Label

EWM01260

WARNING

- Be sure shift control is in neutral before starting engine. (except 2HP)
 - Do not touch or remove electrical parts when starting or during operation.
 - Keep hands, hair, and clothes away from flywheel and other rotating parts while engine is running.
-

EMU25431

Label

EWM01300

WARNING

- This engine is equipped with a neutral starting device.
 - The engine will not start unless the shift control is in neutral position.
-

EMU25441

Label

EWM01311

WARNING

LEAKING FUEL COULD CAUSE A FIRE.

Before tilting up the engine or laying it on its side:

- Turn the fuel cock to the “closed” position.

- Tighten the air-vent screw on the fuel tank cap.
-

EMU25540

Fueling instructions

EWM00010

WARNING

GASOLINE AND ITS VAPORS ARE HIGHLY FLAMMABLE AND EXPLOSIVE!

- Do not smoke when refueling, and keep away from sparks, flames, or other sources of ignition.
 - Stop engine before refueling.
 - Refuel in a well-ventilated area. Refuel portable fuel tanks off the boat.
 - Take care not to spill gasoline. If gasoline spills, wipe it up immediately with dry rags.
 - Do not overfill the fuel tank.
 - Tighten the filler cap securely after refueling.
 - If you should swallow some gasoline, inhale a lot of gasoline vapor, or get gasoline in your eyes, get immediate medical attention.
 - If any gasoline spills onto your skin, immediately wash with soap and water. Change clothing if gasoline spills on it.
 - Touch the fuel nozzle to the filler opening or funnel to help prevent electrostatic sparks.
-

ECM00010

CAUTION:

Use only new clean gasoline which has been stored in clean containers and is not contaminated with water or foreign matter.

General information

EMU25580

Gasoline

Recommended gasoline:
Regular unleaded gasoline with a minimum octane rating of 90 (Research Octane Number).

If knocking or pinging occurs, use a different brand of gasoline or premium unleaded fuel.

EMU25650

Engine oil

Recommended engine oil:
YAMALUBE 2-stroke outboard motor oil

If the recommended engine oil is not available, another 2-stroke engine oil with an NMMA-certified TC-W3 rating may be used.

EMU25742

Propeller selection

The performance of your outboard motor will be critically affected by your choice of propeller, as an incorrect choice could adversely affect performance and could also seriously damage the motor. Engine speed depends on the propeller size and boat load. If engine speed is too high or too low for good engine performance, this will have an adverse effect on the engine.

Yamaha outboard motors are fitted with propellers chosen to perform well over a range of applications, but there may be uses where a propeller with a different pitch would be more appropriate. For a greater operating load, a smaller-pitch propeller is more suitable as it enables the correct engine speed to be maintained. Conversely, a larger-pitch propeller is more suitable for a smaller operating load.

Yamaha dealers stock a range of propellers, and can advise you and install a propeller on your outboard that is best suited to your application.

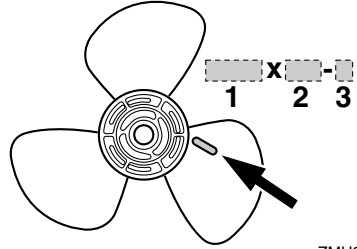

ZMU04604

1. Propeller diameter in inches
2. Propeller pitch in inches
3. Type of propeller (propeller mark)

NOTE: _____
Select a propeller which will allow the engine to reach the middle or upper half of the operating range at full throttle with the maximum boat load. If operating conditions such as light boat loads then allow the engine r/min to rise above the maximum recommended range, reduce the throttle setting to maintain the engine in the proper operating range.

For instructions on propeller removal and installation, see page 37.

EMU25760

Start-in-gear protection

Yamaha outboard motors affixed with the pictured label or Yamaha-approved remote control units are equipped with start-in-gear protection device(s). This feature permits the engine to be started only when it is in neutral. Always select neutral before starting the engine.

General information

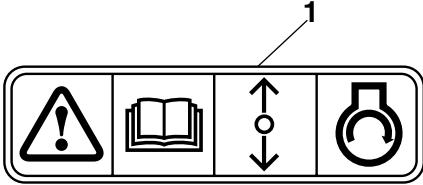

ZMU01713

- 1. Start-in-gear protection label

Basic components

EMU25797

Main components

NOTE:

* May not be exactly as shown; also may not be included as standard equipment on all models.

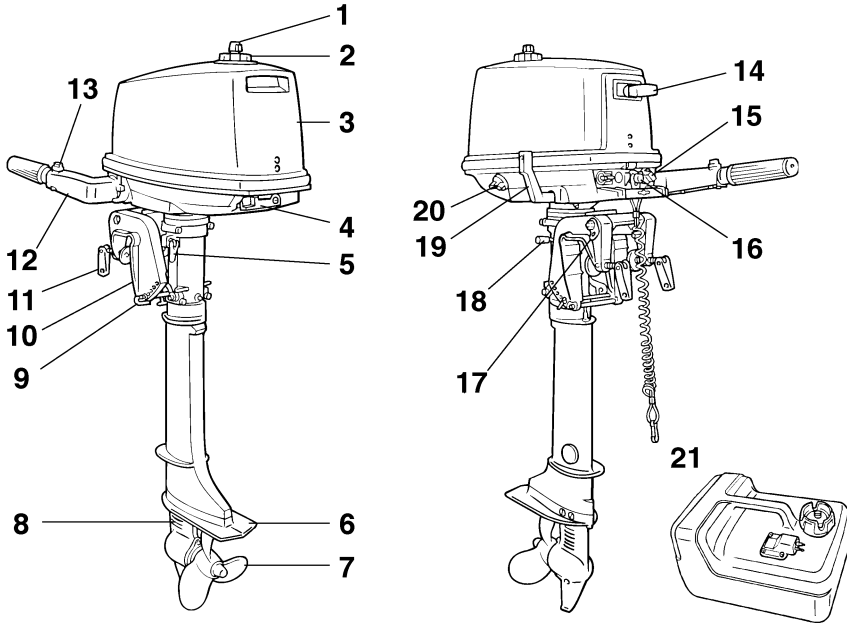

ZMU02763

1. Air vent screw
2. Fuel tank cap
3. Top cowling
4. Top cowling lock lever
5. Steering friction adjuster
6. Anti-cavitation plate
7. Propeller*
8. Cooling water inlet
9. Trim rod
10. Clamp bracket
11. Clamp screw
12. Tiller handle
13. Throttle friction adjuster
14. Manual starter handle
15. Choke knob
16. Engine stop button/Engine stop lanyard switch

17. Rope attachment
18. Tilt support lever
19. Gear shift lever
20. Fuel cock
21. Fuel tank

EMU25802

Fuel tank

If your model was equipped with a portable fuel tank, its function is as follows.

EWM00020



The fuel tank supplied with this engine is its dedicated fuel reservoir and must not be used as a fuel storage container. Com-

Basic components

Commercial users should conform to relevant licensing or approval authority regulations.

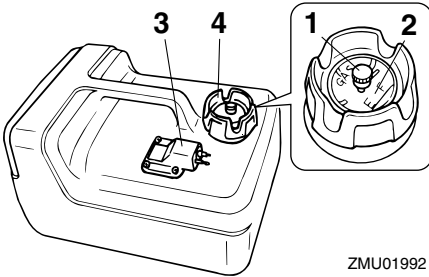

ZMU01992

1. Air vent screw
2. Fuel gauge
3. Fuel joint
4. Fuel tank cap

EMU25821

Fuel tank

If your model included a fuel tank, its parts and functions are as follows.

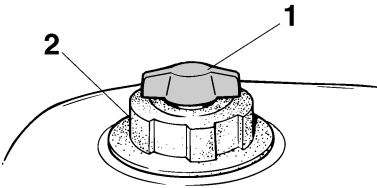

ZMU02427

1. Air vent screw
2. Fuel tank cap

EMU25830

Fuel joint

This joint is used to connect the fuel line.

EMU25841

Fuel gauge

This gauge is located on either the fuel tank cap or on the fuel joint base. It shows the approximate amount of fuel remaining in the tank.

EMU25850

Fuel tank cap

This cap seals the fuel tank. When removed, the tank can be filled with fuel. To remove the cap, turn it counterclockwise.

EMU25860

Air vent screw

This screw is on the fuel tank cap. To loosen the screw, turn it counterclockwise.

EMU25872

Fuel cock

The fuel cock turns on and off the supply of fuel from the fuel tank to the engine.

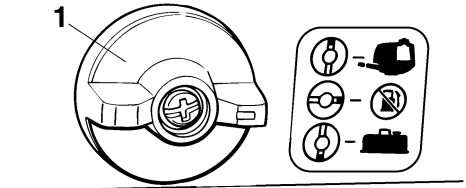

ZMU02766

1. Fuel cock

EMU25881

Close

To stop fuel flow to the engine, turn the lever or knob to close position.

Always turn the lever or knob to close position when the engine is not running.

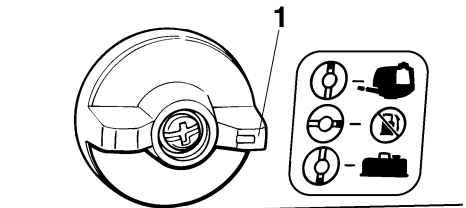

ZMU02768

1. Close position

Basic components

EMU25901

Open

The fuel cock has two open positions, one for selecting fuel flow from the built-in fuel tank, and one for an external tank.

Fuel flows to the carburetor with the lever or knob in either open position. These are the normal running positions.

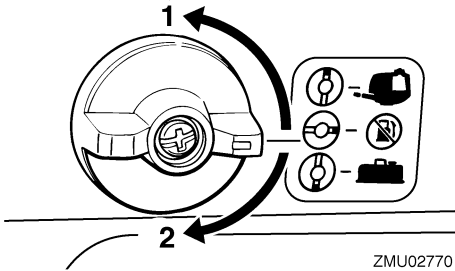

1. "OPEN" position for the built-in tank
2. "OPEN" position for the portable tank

EMU25911

Tiller handle

To change direction, move the tiller handle to the left or right as necessary.

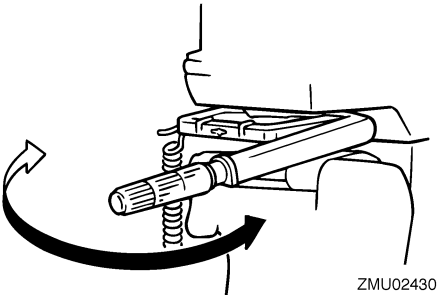

EMU25922

Gear shift lever

Pulling the gear shift lever towards you puts the engine in forward gear so that the boat moves ahead. Pushing the lever away from you puts the engine in reverse gear so that the boat moves astern.

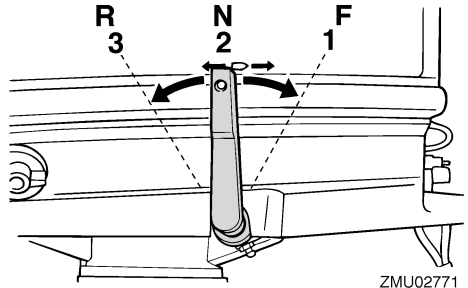

1. Forward "F"
2. Neutral "N"
3. Reverse "R"

EMU25941

Throttle grip

The throttle grip is on the tiller handle. Turn the grip counterclockwise to increase speed and clockwise to decrease speed.

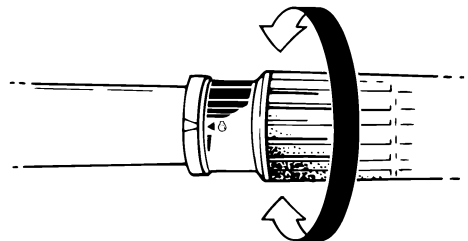

EMU25961

Throttle indicator

The fuel consumption curve on the throttle indicator shows the relative amount of fuel consumed for each throttle position. Choose the setting that offers the best performance and fuel economy for the desired operation.

Basic components

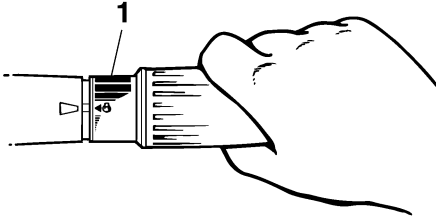

ZMU02433

1. Throttle indicator

EMU25971

Throttle friction adjuster

A friction device provides adjustable resistance to movement of the throttle grip or the remote control lever, and can be set according to operator preference.

To increase resistance, turn the adjuster clockwise. To decrease resistance, turn the adjuster counterclockwise.

EWM00031

WARNING

Do not overtighten the friction adjuster. If there is too much resistance, it could be difficult to move the remote control lever or throttle grip, which could result in an accident.

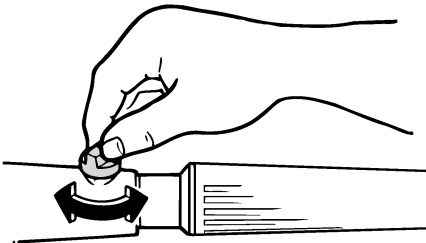

ZMU02772

When constant speed is desired, tighten the adjuster to maintain the desired throttle setting.

EMU25990

Engine stop lanyard switch

The lock plate must be attached to the engine stop switch for the engine to run. The lanyard should be attached to a secure place on the operator's clothing, or arm or leg. Should the operator fall overboard or leave the helm, the lanyard will pull out the lock plate, stopping ignition to the engine. This will prevent the boat from running away under power.

EWM00120

WARNING

- **Attach the engine stop switch lanyard to a secure place on your clothing, or your arm or leg while operating.**
- **Do not attach the lanyard to clothing that could tear loose. Do not route the lanyard where it could become entangled, preventing it from functioning.**
- **Avoid accidentally pulling the lanyard during normal operation. Loss of engine power means the loss of most steering control. Also, without engine power, the boat could slow rapidly. This could cause people and objects in the boat to be thrown forward.**

NOTE:

The engine cannot be started with the lock plate removed.

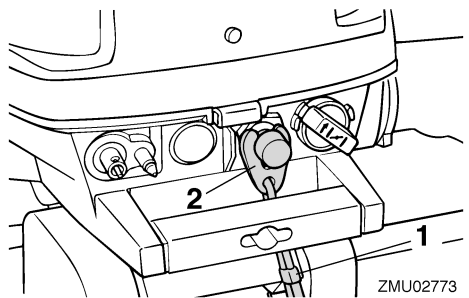

ZMU02773

1. Lanyard
2. Lock plate

Basic components

EMU26001

Engine stop button

To open the ignition circuit and stop the engine, push this button.

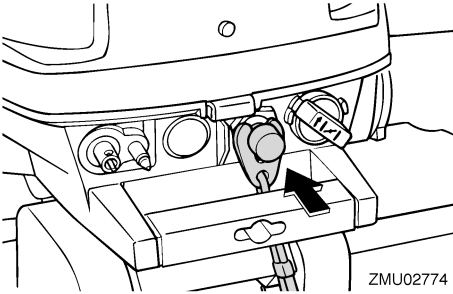

ZMU02774

EMU26020

Choke knob

To supply the engine with the rich fuel mixture required to start, turn this knob to the right.

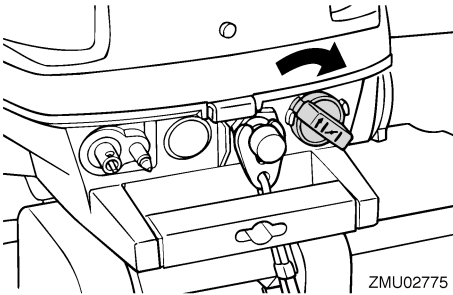

ZMU02775

EMU26070

Manual starter handle

To start the engine, first gently pull the handle out until resistance is felt. From that position, then pull the handle straight out quickly to crank the engine.

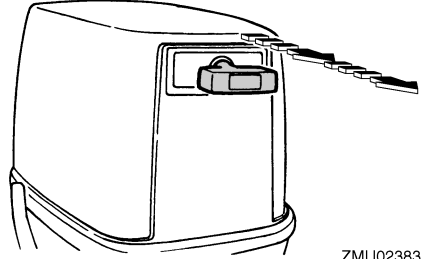

ZMU02383

EMU26122

Steering friction adjuster

A friction device provides adjustable resistance to the steering mechanism, and can be set according to operator preference. An adjusting screw or bolt is located on the swivel bracket.

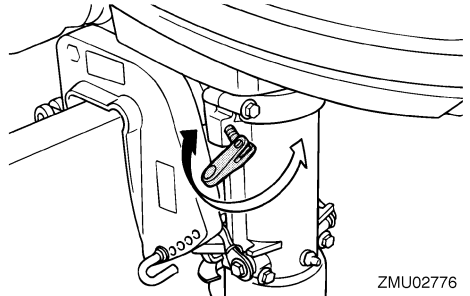

ZMU02776

To increase resistance, turn the adjuster clockwise.

To decrease resistance, turn the adjuster counterclockwise.

EWMM00040



WARNING

Do not overtighten the friction adjuster. If there is too much resistance, it could be difficult to steer, which could result in an accident.

EMU26261

Trim rod (tilt pin)

The position of the trim rod determines the minimum trim angle of the outboard motor in relation to the transom.

Basic components

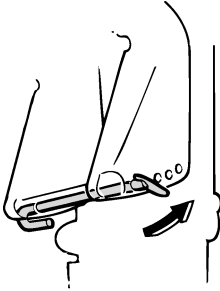

ZMU02777

EMU26330

Tilt support bar

The tilt support bar keeps the outboard motor in the tilted up position.

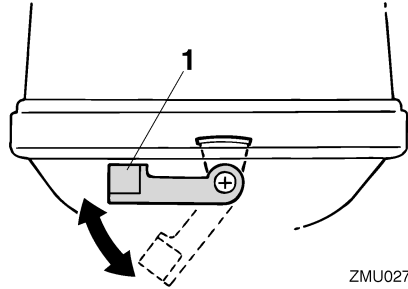

ZMU02779

1. Top cowling lock lever(s)

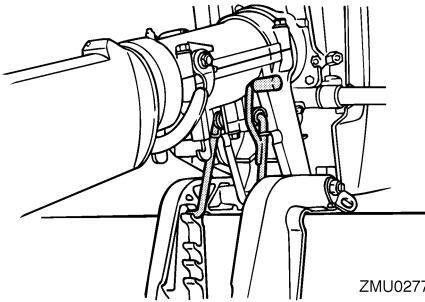

ZMU02778

EMU26372

Top cowling lock lever(s) (turn type)

To remove the engine top cowling, turn the lock lever(s) and lift off the cowling. When installing the cowling, check to be sure it fits properly in the rubber seal. Then lock the cowling again by returning the lever(s) to the lock position.

EMU26901

Installation

ECM00110

CAUTION:

Incorrect engine height or obstructions to smooth water flow (such as the design or condition of the boat, or accessories such as transom ladders or depth finder transducers) can create airborne water spray while the boat is cruising. Severe engine damage may result if the motor is operated continuously in the presence of airborne water spray.

NOTE:

During water testing check the buoyancy of the boat, at rest, with its maximum load. Check that the static water level on the exhaust housing is low enough to prevent water entry into the powerhead, when water rises due to waves when the outboard is not running.

EMU26910

Mounting the outboard motor

EWM00820

WARNING

- Overpowering a boat could cause severe instability. Do not install an outboard motor with more horsepower than the maximum rating on the capacity plate of the boat. If the boat does not have a capacity plate, consult the boat manufacturer.
- The information presented in this section is intended as reference only. It is not possible to provide complete instructions for every possible boat and motor combination. Proper mounting depends in part on experience and the specific boat and motor combination.

EWM00830

WARNING

Improper mounting of the outboard motor could result in hazardous conditions such as poor handling, loss of control, or fire hazards. Observe the following:

- For permanently mounted models, your dealer or other person experienced in proper rigging should mount the motor. If you are mounting the motor yourself, you should be trained by an experienced person.
- For portable models, your dealer or other person experienced in proper outboard motor mounting should show you how to mount your motor.

Mount the outboard motor on the center line (keel line) of the boat, and ensure that the boat itself is well balanced. Otherwise the boat will be hard to steer. For boats without a keel or which are asymmetrical, consult your dealer.

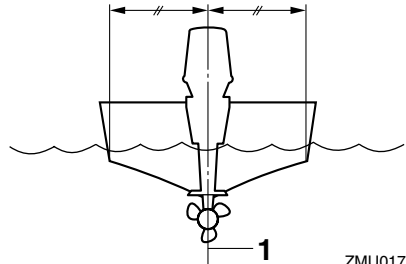

ZMU01760

1. Center line (keel line)

EMU26920

Mounting height

To run your boat at optimum efficiency, the water resistance (drag) of the boat and outboard motor must be made as little as possible. The mounting height of the outboard motor greatly affects the water resistance. If the mounting height is too high, cavitation

Operation

tends to occur, thus reducing the propulsion; and if the propeller tips cut the air, the engine speed will rise abnormally and cause the engine to overheat. If the mounting height is too low, the water resistance will increase and thereby reduce engine efficiency. Mount the outboard motor so that the anti-cavitation plate is between the bottom of the boat and a level 25 mm (1 in.) below it.

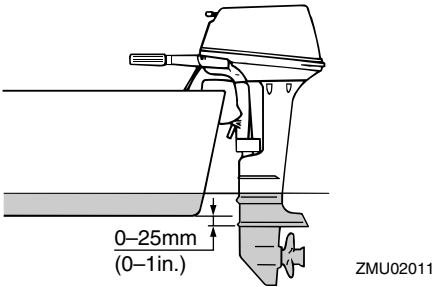

NOTE:

- The optimum mounting height of the outboard motor is affected by the boat and motor combination and the desired use. Test runs at different heights can help determine the optimum mounting height. Consult your Yamaha dealer or boat manufacturer for further information on determining the proper mounting height.
- For instructions on setting the trim angle of the outboard motor, see page 23.

EMU26970

Clamping the outboard motor

1. Place the outboard motor on the transom so that it is positioned as close to the center as possible. Tighten the transom clamp screws evenly and securely. Occasionally check the clamp screws for tightness during operation of the outboard motor because they could become loose due to engine vibration.

EWMO0640

WARNING

Loose clamp screws could allow the outboard motor to fall off or move on the transom. This could cause loss of control and serious injury. Make sure the transom screws are tightened securely. Occasionally check the screws for tightness during operation.

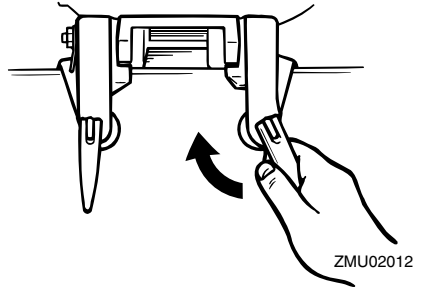

2. If the engine restraint cable attachment is equipped on your engine, an engine restraint cable or chain should be used. Attach one end to the engine restraint cable attachment and the other to a secure mounting point on the boat. Otherwise the engine could be completely lost if it accidentally falls off the transom.

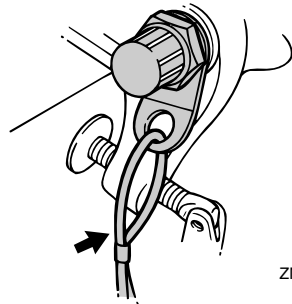

- Secure the clamp bracket to the transom using the bolts provided with the outboard (if packed). For details, consult your Yamaha dealer.

EWM00650

WARNING

Avoid using bolts, nuts or washers other than those contained in the engine packaging. If used, they must be of at least the same quality of material and strength and must be tightened securely. After tightening, test run the engine and check their tightness.

EMU30173

Breaking in engine

Your new engine requires a period of break-in to allow mating surfaces of moving parts to wear in evenly. Correct break-in will help ensure proper performance and longer engine life.



ECM00800

CAUTION:



Failure to follow the break-in procedure could result in reduced engine life or even severe engine damage.

EMU27060

Gasoline and engine oil mixing chart (50:1)

		50:1			
		1 L	12 L	14 L	24 L
		(0.26 US gal, 0.22 Imp gal)	(3.2 US gal, 2.6 Imp gal)	(3.7 US gal, 3.1 Imp gal)	(6.3 US gal, 5.3 Imp gal)
		0.02L (0.02 US qt, 0.02 Imp qt)	0.24 L (0.25 US qt, 0.21 Imp qt)	0.28 L (0.3US qt, 0.25 Imp qt)	0.48 L (0.51 US qt, 0.42Imp qt)

ZMU02442

- : Gasoline
- : Engine oil

ECM00150

CAUTION:

Be sure to mix gasoline and oil completely, otherwise the engine may be damaged.

EMU27074

Procedure for pre-mixed models

Run the engine under load (in gear with a propeller installed) for 10 hours as follows.

- First 10 minutes:
 - Run the engine at the lowest possible speed. A fast idle in neutral is best.
- Next 50 minutes:
 - Do not exceed half throttle (approximately 3000 r/min). Vary engine speed occasionally. If you have an easy-planing boat, accelerate at full throttle onto plane, then immediately reduce the throttle to 3000 r/min or less.
- Next two hours:
 - Accelerate at full throttle onto plane, then reduce engine speed to three-quarter throttle (approximately 4000 r/min). Vary engine speed occasionally. Run at full throttle for one minute, then allow about 10 minutes of operation at three-quarter throttle or less to let the engine cool.
- Remaining seven hours:
 - Run the engine at any speed. However, avoid operating at full throttle for more than 5 minutes at a time.
- After the first 10 hours:
 - Operate the engine normally. Use the standard premix ratio of gasoline and oil. For details on mixing fuel and oil, see page 15.

Operation

EMU27102

Preoperation checks

EWM00080

WARNING

If any item in the preoperation check is not working properly, have it inspected and repaired before operating the outboard motor. Otherwise an accident could occur.

ECM00120

CAUTION:

Do not start the engine out of water. Overheating and serious engine damage can occur.

EMU27111

Fuel

- Check to be sure you have plenty of fuel for your trip.
- Make sure there are no fuel leaks or gasoline fumes.
- Check fuel line connections to be sure they are tight (if equipped Yamaha fuel tank or boat tank).
- Be sure the fuel tank is positioned on a secure, flat surface, and that the fuel line is not twisted or flattened, or likely to contact sharp objects (if equipped Yamaha fuel tank or boat tank).

EMU27120

Oil

- Check to be sure you have plenty of oil for your trip.

EMU27130

Controls

- Check throttle, shift, and steering for proper operation before starting the engine.
- The controls should work smoothly, without binding or unusual free play.
- Look for loose or damaged connections.
- Check operation of the starter and stop switches when the outboard motor is in the water.

EMU27140

Engine

- Check the engine and engine mounting.
- Look for loose or damaged fasteners.
- Check the propeller for damage.

EMU27233

Filling fuel and engine oil

EMU27242

Filling fuel for portable tank

EWM00060

WARNING

Gasoline and its vapors are highly flammable and explosive. Keep away from sparks, cigarettes, flames, or other sources of ignition.

1. Remove the fuel tank cap.
 2. Fill the fuel tank carefully.
 3. Close the cap securely after refueling.
- Wipe up any spilled fuel.

Fuel tank capacity (if equipped Yamaha fuel tank):
12.0 L (3.17 US gal) (2.64 Imp.gal)

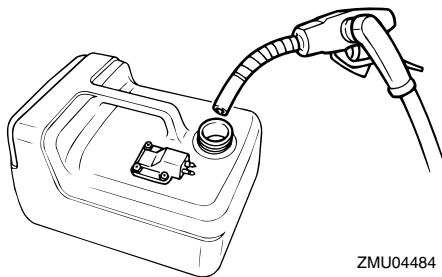

ZMU04484

EMU27253

Filling fuel for built-in tank

EWM00060

WARNING

Gasoline and its vapors are highly flammable and explosive. Keep away from sparks, cigarettes, flames, or other sources of ignition.

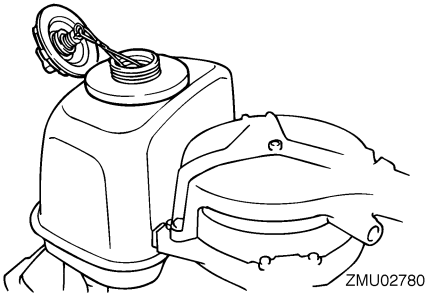

ZMU02780



1. With the outboard motor tilted down (in the vertical running position), remove the fuel tank cap.
2. Use a funnel if the nozzle on the fuel can or pump is not small enough or long enough to fit into the mouth of the fuel tank.
3. Fill the fuel tank carefully.
4. Securely close the cap after refueling. Wipe up any spilled fuel.

Fuel tank capacity:
2.8 L (0.74 US gal) (0.62 Imp.gal)



EMU27404

Gasoline and oil mixing (100:1)

	Gasoline to engine oil ratio
Break-in period	See page 14
After break-in	100:1

	100:1			
	1 L (0.26 US gal, 0.22 Imp gal)	12 L (3.2 US gal, 2.6 Imp gal)	14 L (3.7 US gal, 3.1 Imp gal)	24 L (6.3 US gal, 5.3 Imp gal)
	0.01 L (0.01 US qt, 0.01 Imp qt)	0.12 L (0.13 US qt, 0.11 Imp qt)	0.14 L (0.15 US qt, 0.12 Imp qt)	0.24 L (0.25 US qt, 0.21 Imp qt)

ZMU04910

1. : Gasoline
2. : Engine oil

If equipped with a portable fuel tank

1. Pour oil into the portable fuel tank, and then add gasoline.

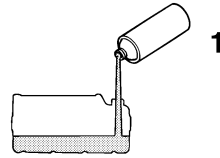

1

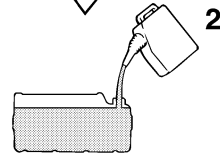

2

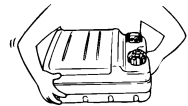

ZMU02394

1. Engine oil
2. Gasoline
2. Replace the fuel tank cap and close tightly.
3. Shake the fuel tank to mix the fuel thoroughly.
4. Make sure that the oil and gasoline are mixed.

If equipped with a built-in fuel tank

1. Pour oil into a clean fuel can, and then add gasoline.

Operation

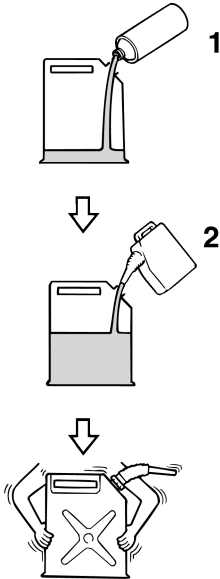

ZMU02886

1. Engine oil
2. Gasoline
2. Replace the fuel can cap and close tightly.
3. Shake the fuel can to mix the fuel thoroughly.
4. Make sure that the oil and gasoline are mixed.
5. Pour the gasoline and oil mixture into the built-in fuel tank.

ECM00810

CAUTION:

- Avoid using any oil other than the specified type.
- Use a thoroughly blended fuel-oil mixture.
- If the mixture is not thoroughly mixed, or if the mixing ratio is incorrect, the following problems could occur. Low oil ratio: Lack of oil could cause major engine trouble, such as piston seizure.

- High oil ratio: Too much oil could cause fouled spark plugs, smoky exhaust, and heavy carbon deposits.

NOTE:

If using a permanently installed tank, pour the oil gradually as the gasoline is being added to the tank.

EMU27450

Operating engine

EMU27461

Feeding fuel (portable tank)

EWM00420

WARNING

- Before starting the engine, make sure that the boat is tightly moored and that you can steer clear of any obstructions. Be sure there are no swimmers in the water near you.
 - When the air vent screw is loosened, gasoline vapor will be released. Gasoline is highly flammable, and its vapors are flammable and explosive. Refrain from smoking, and keep away from open flames and sparks while loosening the air vent screw.
 - This product emits exhaust gases which contain carbon monoxide, a colorless, odorless gas which could cause brain damage or death when inhaled. Symptoms include nausea, dizziness, and drowsiness. Keep cockpit and cabin areas well ventilated. Avoid blocking exhaust outlets.
1. If there is an air vent screw on the fuel tank cap, loosen it 2 or 3 turns.

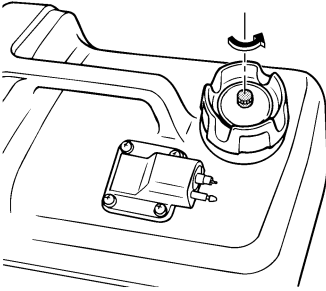

ZMU02237

2. If there is a fuel joint on the motor, firmly connect the fuel line to the joint. Then firmly connect the other end of the fuel line to the joint on the fuel tank.

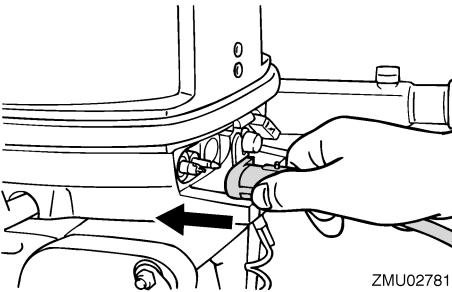

ZMU02781

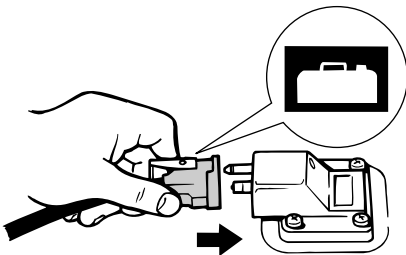

ZMU02024

3. If a steering friction adjuster is provided on your outboard motor, securely attach the fuel line to the fuel line clamp.

NOTE:

During engine operation place the tank horizontally, otherwise fuel cannot be drawn from the fuel tank.

4. Squeeze the primer pump with the outlet end up until you feel it become firm.



ZMU02025

EMU27472

Feeding fuel

EWM00420

WARNING

- Before starting the engine, make sure that the boat is tightly moored and that you can steer clear of any obstructions. Be sure there are no swimmers in the water near you.
- When the air vent screw is loosened, gasoline vapor will be released. Gasoline is highly flammable, and its vapors are flammable and explosive. Refrain from smoking, and keep away from open flames and sparks while loosening the air vent screw.
- This product emits exhaust gases which contain carbon monoxide, a colorless, odorless gas which could cause brain damage or death when inhaled. Symptoms include nausea, dizziness, and drowsiness. Keep cockpit and cabin areas well ventilated. Avoid blocking exhaust outlets.

Operation

1. For the built in tank, loosen the air vent screw on the fuel tank cap by one turn. For the external fuel tank, loosen it on the fuel tank cap by 2 or 3 turns.

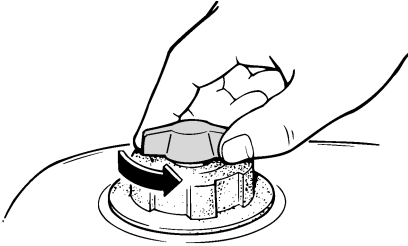

ZMU02443

2. Select the fuel tank using the fuel cock or open the fuel cock.

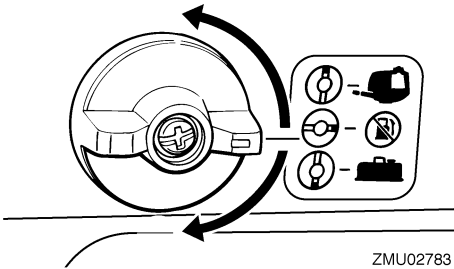

ZMU02783

3. If you are using an external fuel tank, connect the fuel joints securely and squeeze the primer pump with the outlet end up until you feel it become firm (if equipped the fuel joint).

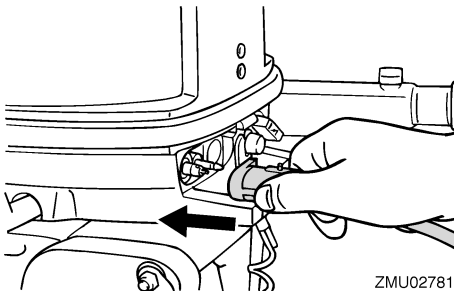

ZMU02781

EMU27490

Starting engine

EMU27505

Manual start models (tiller control)

1. Place the gear shift lever in neutral.

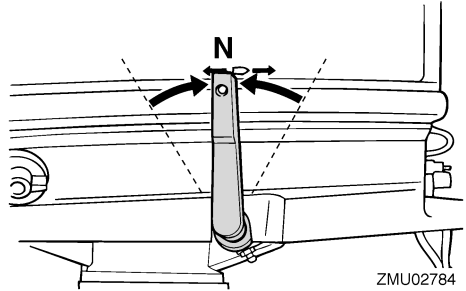

ZMU02784

NOTE:

The start-in-gear protection device prevents the engine from starting except when in neutral.

2. Attach the engine stop switch lanyard to a secure place on your clothing, or your arm or leg. Then install the lock plate on the other end of the lanyard into the engine stop switch.

EWM00120

WARNING

- Attach the engine stop switch lanyard to a secure place on your clothing, or your arm or leg while operating.
- Do not attach the lanyard to clothing that could tear loose. Do not route the lanyard where it could become entangled, preventing it from functioning.
- Avoid accidentally pulling the lanyard during normal operation. Loss of engine power means the loss of most steering control. Also, without engine power, the boat could slow rapidly. This could cause people and objects in the boat to be thrown forward.

Operation

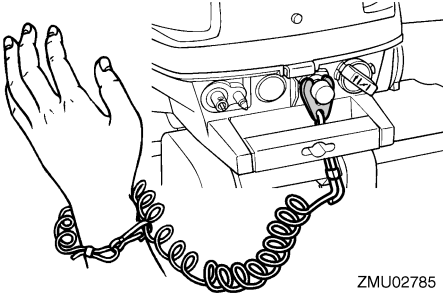

ZMU02785

3. Place the throttle grip in the "START" (start) position.

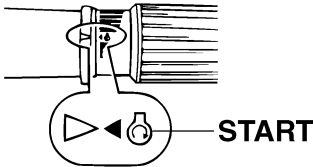

ZMU02446

4. Pull out / turn the choke knob fully. After the engine starts, replace / return the knob to the home position.

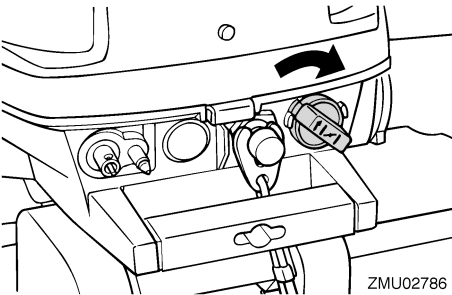

ZMU02786

NOTE:

- It is not necessary to use the choke when starting a warm engine.

- If the choke knob is left in the "START" (start) position while the engine is running, the engine will run poorly or stall.

5. Pull the manual starter handle slowly until you feel resistance. Then give a strong pull straight out to crank and start the engine. Repeat if necessary.

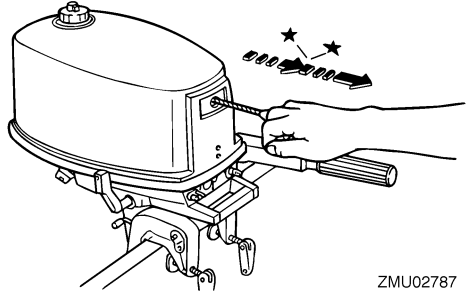

ZMU02787

6. After the engine starts, slowly return the manual starter handle to its original position before releasing it.
7. Slowly return the throttle grip to the fully closed position.

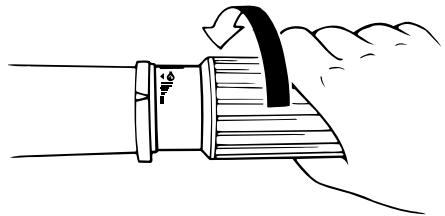

ZMU02030

NOTE:

- When the engine is cold, it needs to be warmed up. For further information, see page 21.
- If the engine does not start on the first try, repeat the procedure. If the engine fails to start after 4 or 5 tries, open the throttle a small amount (between 1/8 and 1/4) and try

Operation

again. Also if the engine is warm and fails to start, open the throttle a same amount and try to start the engine again. If the engine still fails to start, see page 42.

EMU27670

Warming up engine

EMU27681

Choke start models

1. After starting the engine, allow it to idle for 3 minutes to warm up. Failure to do so will shorten engine life. Gradually return the choke knob to its home position as the engine warms up.
2. Check for a steady flow of water from the cooling water pilot hole.

ECM00511

CAUTION:

A continuous flow of water from the cooling water pilot hole shows that the water pump is pumping water through the cooling passages. If water is not flowing out of the hole at all times while the engine is running, overheating and serious damage could occur. Stop the engine and check whether the cooling water inlet on the lower case or the cooling water pilot hole is blocked. Consult your Yamaha dealer if the problem cannot be located and corrected.

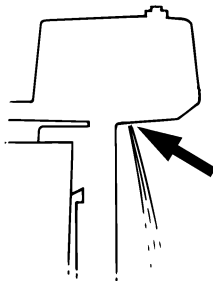

ZMU02447

EMU27740

Shifting

EWMO0180

WARNING

Before shifting, make sure there are no swimmers or obstacles in the water near you.

ECM00220

CAUTION:

To change the boat direction or shifting position from forward to reverse or vice-versa, first close the throttle so that the engine idles (or runs at low speeds).

EMU27764

Forward (tiller handle and remote control models)

Tiller handle models

1. Place the throttle grip in the fully closed position.

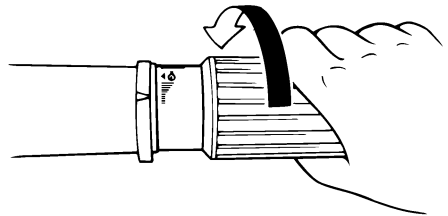

ZMU02448

2. Move the gear shift lever quickly and firmly from neutral to forward.

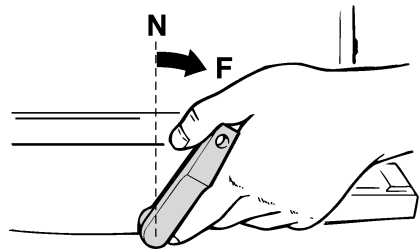

ZMU02788

Remote control models

Pull up the neutral interlock trigger (if equipped) and move the remote control lever quickly and firmly from neutral to forward.

EMU27801

Reverse

EWM00190

WARNING

When operating in reverse, go slowly. Do not open the throttle more than half. Otherwise the boat could become unstable, which could result in loss of control and an accident.

1. Place the throttle grip in the fully closed position.

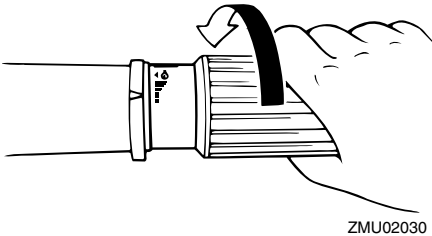

2. Move the gear shift lever quickly and firmly from neutral to reverse.

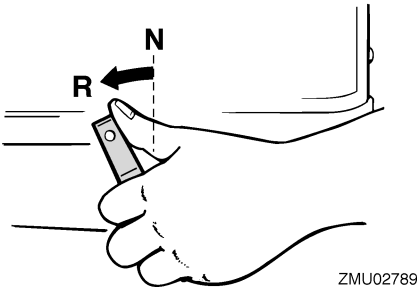

NOTE: _____

The outboard motor can turn 360° in its bracket (full-pivot system). The boat can also be backed up by simply turning the outboard motor around 180° with the steering handle facing toward you.

EMU27820

Stopping engine

Before stopping the engine, first let it cool off for a few minutes at idle or low speed. Stopping the engine immediately after operating at high speed is not recommended.

EMU27832

Procedure

1. Push and hold the engine stop button until the engine comes to a complete stop.

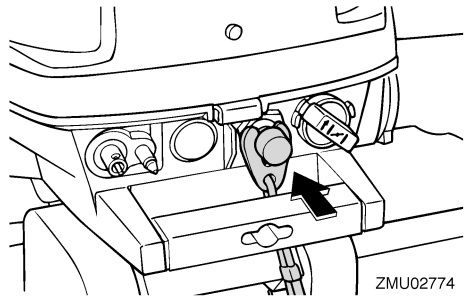

2. After stopping the engine, tighten the air vent screw on the fuel tank cap and set the fuel cock lever or knob to the closed position, if equipped.

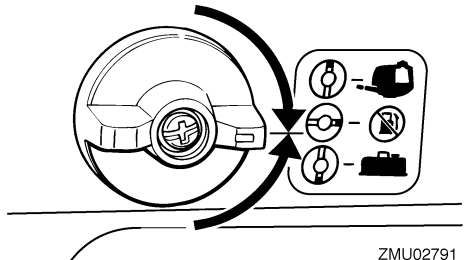

Operation

3. Disconnect the fuel line if you are using an external fuel tank.

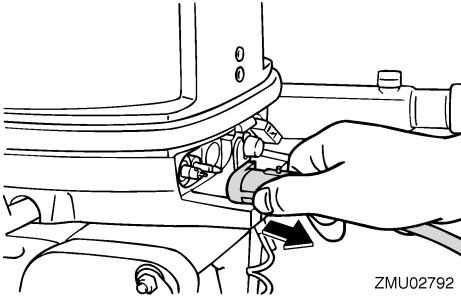

NOTE:

If the outboard motor is equipped with an engine stop switch lanyard, the engine can also be stopped by pulling the lanyard and removing the lock plate from the engine stop switch.

EMU27861

Trimming outboard motor

The trim angle of the outboard motor helps determine the position of the bow of the boat in the water. Correct trim angle will help improve performance and fuel economy while reducing strain on the engine. Correct trim angle depends upon the combination of boat, engine, and propeller. Correct trim is also affected by variables such as the load in the boat, sea conditions, and running speed.

EWM00740

WARNING

Excessive trim for the operating conditions (either trim up or trim down) can cause boat instability and can make steering the boat more difficult. This increases the possibility of an accident. If the boat begins to feel unstable or is hard to steer, slow down and/or readjust the trim angle.

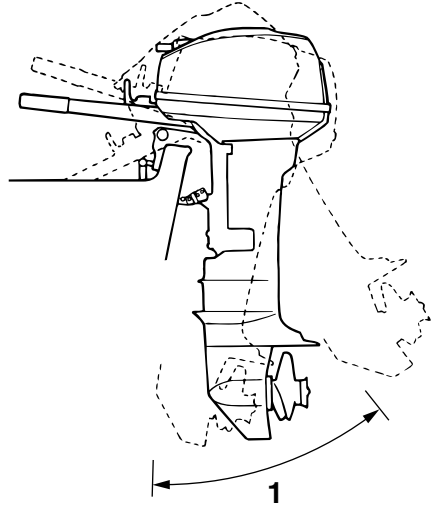

1. Trim operating angle

EMU27872

Adjusting trim angle for manual tilt models

There are 4 or 5 holes provided in the clamp bracket to adjust the outboard motor trim angle.

1. Stop the engine.
2. Tilt the outboard motor up, and then remove the trim rod from the clamp bracket.

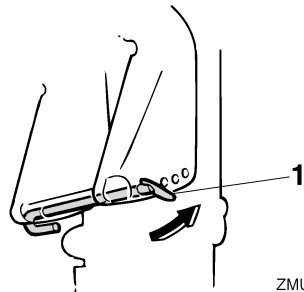

1. Trim rod
3. Reposition the rod in the desired hole.

To raise the bow (“trim-out”), move the rod away from the transom.

To lower the bow (“trim-in”), move the rod toward the transom.

Make test runs with the trim set to different angles to find the position that works best for your boat and operating conditions.

EWMM00400

WARNING

- **Stop the engine before adjusting the trim angle.**
- **Use care to avoid being pinched when removing or installing the rod.**
- **Use caution when trying a trim position for the first time. Increase speed gradually and watch for any signs of instability or control problems. Improper trim angle can cause loss of control.**

NOTE:

The outboard motor trim angle can be changed approximately 4 degrees by shifting the trim rod one hole.

EMU27911

Adjusting boat trim

When the boat is on plane, a bow-up attitude results in less drag, greater stability and efficiency. This is generally when the keel line of the boat is up about 3 to 5 degrees. With the bow up, the boat may have a greater tendency to steer to one side or the other. Compensate for this as you steer. The trim tab can also be adjusted to help offset this effect. When the bow of the boat is down, it is easier to accelerate from a standing start onto plane.

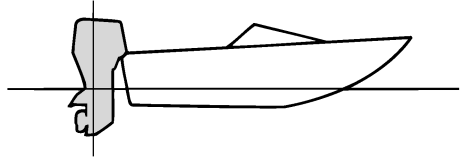

ZMU01784

Bow Up

Too much trim-out puts the bow of the boat too high in the water. Performance and economy are decreased because the hull of the boat is pushing the water and there is more air drag. Excessive trim-out can also cause the propeller to ventilate, which reduces performance further, and the boat may “porpoise” (hop in the water), which could throw the operator and passengers overboard.

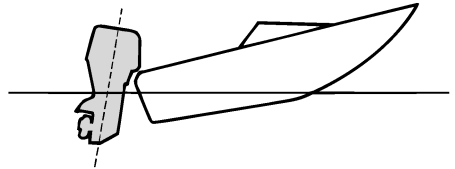

ZMU01785

Bow Down

Too much trim-in causes the boat to “plow” through the water, decreasing fuel economy and making it hard to increase speed. Operating with excessive trim-in at higher speeds also makes the boat unstable. Resistance at the bow is greatly increased, heightening the danger of “bow steering” and making operation difficult and dangerous.

Operation

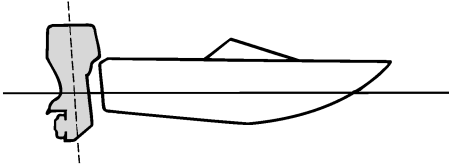

ZMU01786

NOTE:

Depending on the type of boat, the outboard motor trim angle may have little effect on the trim of the boat when operating.

EMU27921

Tilting up and down

If the engine will be stopped for some time or if the boat is moored in shallows, the outboard motor should be tilted up to protect the propeller and casing from damage by collision with obstructions, and also to reduce salt corrosion.

EWM00220

WARNING

Be sure all people are clear of the outboard motor when tilting up and down, also be careful not to pinch any body parts between the drive unit and engine bracket.

EWM00230

WARNING

Leaking fuel is a fire hazard. Tighten the air vent screw and place the fuel cock in the closed position if the outboard motor will be tilted for more than a few minutes. Otherwise fuel may leak.

ECM00231

CAUTION:

● Before tilting the outboard motor, follow the procedure under “Stopping engine” in this chapter. Never tilt the outboard

motor while the engine is running. Severe damage from overheating can result.

- Do not tilt up the engine by pushing the tiller handle because this could break the handle.
- Keep the power unit higher than the propeller at all times. Otherwise water could run into the cylinder and cause damage.
- The outboard motor cannot be tilted when in reverse or when the outboard motor is turned 180° (facing the rear).

EMU27964

Procedure for tilting up (manual tilt models)

1. Place the gear shift lever in neutral (if equipped) and face the outboard motor forward.

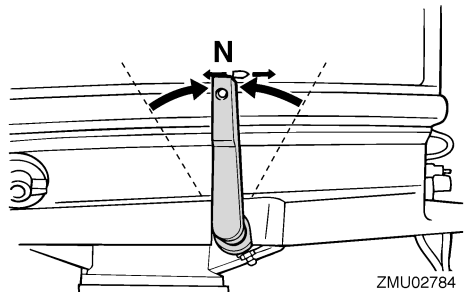

ZMU02784

2. On full-pivot system models, tighten the steering friction adjuster by turning it clockwise to prevent the motor from turning freely.
3. Tighten the air vent screw. On models equipped with a fuel joint, disconnect the fuel line from the outboard motor.



ZMU02450

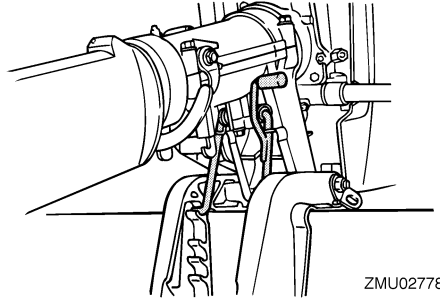

ZMU02778

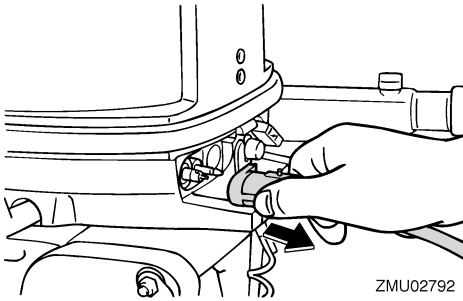

ZMU02792

4. Close the fuel cock.

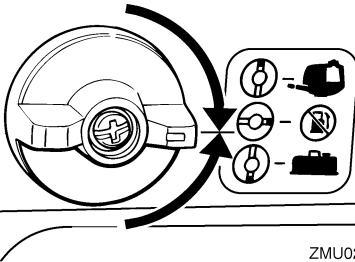

ZMU02791

5. Tilt support bar equipped models: Hold the rear of the top cowling or the rear handle (if equipped) with one hand and tilt the outboard motor up fully until the tilt support bar automatically locks.

6. Tilt support knob equipped models: Hold the rear of the top cowling with one hand, fully tilt the outboard motor up, and push the tilt support knob into the clamp bracket.
7. Tilt support lever equipped models: Hold the rear handle and tilt the engine up fully until the tilt support lever automatically locks.

NOTE:

Tilt support lever/bar equipped models: If the motor is not facing forward, the tilt support lever/bar cannot automatically turn to the locked position. If the tilt support lever/bar does not automatically lock, swing the motor a little to the left and right.

EMU28032

Procedure for tilting down (manual tilt models)

1. Slightly tilt the outboard motor up.
2. If equipped with the tilt support bar: Slowly tilt the outboard motor down while pulling the tilt support bar lever up.

Operation

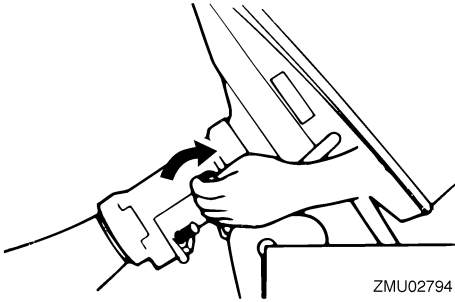

3. If equipped with the tilt support knob: Pull the knob out, and then slowly tilt the outboard motor down.
4. If equipped with the tilt support lever: Slowly tilt the outboard motor down while pulling the tilt support lever up.
5. Loosen the steering friction adjuster by turning it counterclockwise, and adjust the steering friction according to operator preference.

EWU00720

WARNING

If there is too much resistance it could be difficult to steer, which could result in an accident.

EMU28060

Cruising in shallow water

The outboard motor can be tilted up partially to allow operation in shallow water.

EMU28071

Cruising in shallow water (manual tilt models)

EWU00710

WARNING

- Place the gear shift in neutral before using the shallow water cruising system.
- Run the boat at the lowest possible speed when using the shallow water cruising system. The tilt lock mechanism does not work while the shallow water cruising system is being used. Hit-

ting an underwater obstacle could cause the outboard motor to lift out of the water, resulting in loss of control.

- Do not rotate the outboard motor 180° and operate the boat in reverse. Place the gear shift in reverse to operate the boat in reverse.
- Use extra care when operating in reverse. Too much reverse thrust can cause the outboard motor to lift out of the water, increasing the chance of accident and personal injury.
- Return the outboard motor to its normal position as soon as the boat is back in deeper water.

ECM00260

CAUTION:

Do not tilt the outboard motor up so that the cooling water inlet on the lower unit is above the surface of the water when setting up for and cruising in shallow water. Otherwise severe damage from overheating can result.

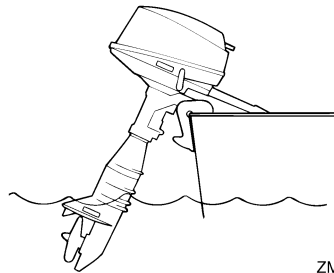

EMU28101

Procedure

1. Place the gear shift lever in neutral and face the outboard motor forward.

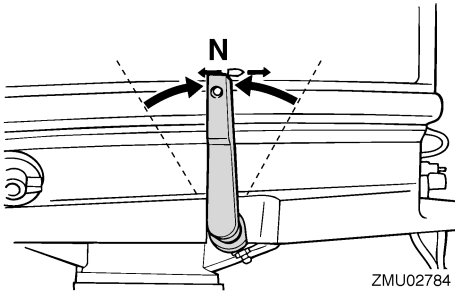

2. Slightly tilt the outboard motor up until the tilt support bar automatically turns to the lock position to support the engine.

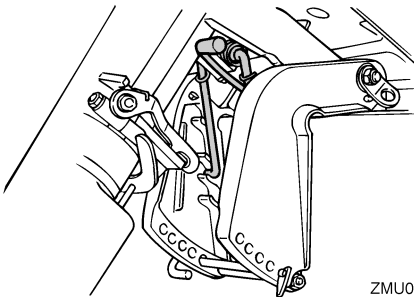

3. To lower the outboard motor to the normal running position, first slightly tilt the outboard motor up. Then pull up the tilt support bar lever and slowly tilt the engine down.

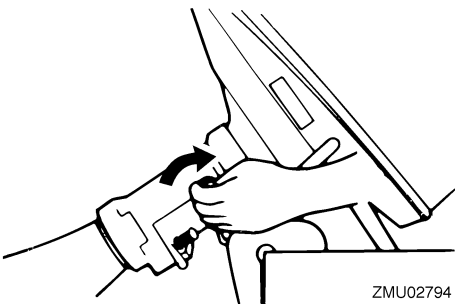

NOTE: _____

The outboard motor is equipped with 2 or 3 positions for shallow water cruising.

EMU28192

Cruising in other conditions

Cruising in salt water

After operating in salt water, flush the cooling water passages with fresh water to prevent them from becoming clogged with salt deposits.

NOTE: _____

For cooling system flushing instructions, see page 30.

Cruising in turbid water

Yamaha strongly recommends that you use the optional chromium-plated water pump kit (not available for some models) if you use the outboard motor in turbid or muddy water conditions.

Maintenance

EMU31480

Specifications

NOTE:

“(AL)” stated in the specification data below represents the numerical value for the aluminum propeller installed.

Likewise, “(SUS)” represents the value for stainless steel propeller installed and “(PL)” for plastic propeller installed.

EMU28218

Dimension:

- Overall length:
677 mm (26.7 in)
- Overall width:
322 mm (12.7 in)
- Overall height S:
1011 mm (39.8 in)
- Overall height L:
1138 mm (44.8 in)
- Transom height S:
444 mm (17.5 in)
- Transom height L:
571 mm (22.5 in)
- Weight (AL) S:
21.0 kg (46 lb)
- Weight (AL) L:
21.5 kg (47 lb)

Performance:

- Full throttle operating range:
4500–5500 r/min
- Maximum output:
3.7 kW @ 5000 r/min (5 HP @ 5000 r/min)
- Idling speed (in neutral):
1150 ±50 r/min

Engine:

- Type:
2-stroke S
- Displacement:
103.0 cm³ (6.29 cu.in)
- Bore × stroke:
54.0 × 45.0 mm (2.13 × 1.77 in)
- Ignition system:
CDI
- Spark plug (NGK):
BR7HS

- Spark plug gap:
0.6–0.7 mm (0.024–0.028 in)
- Control system:
Tiller
- Starting system:
Manual
- Starting carburetion system:
Choke valve
- Alternator output:
40/60 W

Drive unit:

- Gear positions:
Forward-neutral-reverse
- Gear ratio:
2.08 (27/13)
- Trim and tilt system:
Manual tilt
- Propeller mark:
BA

Fuel and oil:

- Recommended fuel:
Regular unleaded gasoline
- Min. research octane:
90
- Fuel tank capacity:
12.0 L (3.17 US gal) (2.64 Imp.gal)
- Fuel tank capacity (built in type):
2.8 L (0.74 US gal) (0.62 Imp.gal)
- Recommended engine oil:
YAMALUBE 2-stroke outboard motor oil
- Fuel:oil ratio:
Regular gasoline:
100 :1
- Lubrication:
Pre-mixed fuel and oil
- Recommended gear oil:
Hypoid gear oil SAE#90
- Gear oil quantity:
100.0 cm³ (3.38 US oz) (3.53 Imp.oz)

Tightening torque for engine:

- Spark plug:
25.0 Nm (18.4 ft-lb) (2.55 kgf-m)

EMU28222

Transporting and storing outboard motor

EWM00690

WARNING

- Leaking fuel is a fire hazard. When transporting and storing the outboard motor, close the air vent screw and fuel cock to prevent fuel from leaking.
- USE CARE when transporting fuel tank, whether in a boat or car.
- DO NOT fill fuel container to maximum capacity. Gasoline will expand considerably as it warms up and can build up pressure in the fuel container. This can cause fuel leakage and a potential fire hazard.

EWM00700

WARNING

Never get under the lower unit while it is tilted, even if a motor support bar is used. Severe injury could occur if the outboard motor accidentally falls.

ECM00660

CAUTION:

Do not use the tilt support lever or knob when trailering the boat. The outboard motor could shake loose from the tilt support and fall. If the motor cannot be trailered in the normal running position, use an additional support device to secure it in the tilt position.

The outboard motor should be trailered and stored in the normal running position. If there is insufficient road clearance in this position, then trailer the outboard motor in the tilt position using a motor support device such as a transom saver bar. Consult your Yamaha dealer for further details.

EMU28235

Clamp screw mounting models

When transporting or storing the outboard motor while removed from a boat, keep the outboard motor in the attitude shown.

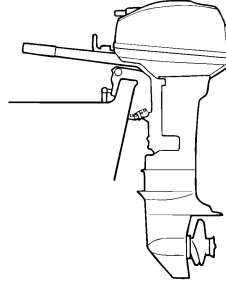

ZMU02796

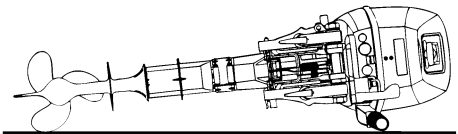

ZMU02458

NOTE:

Place a towel or something similar under the outboard motor to protect it from damage.

EMU30272

Storing outboard motor

When storing your Yamaha outboard motor for prolonged periods of time (2 months or longer), several important procedures must be performed to prevent excessive damage. It is advisable to have your outboard motor serviced by an authorized Yamaha dealer prior to storage. However, you, the owner, with a minimum of tools, can perform the following procedures.

Maintenance

ECM01411

CAUTION:

- Do not place the outboard motor on its side before the cooling water has drained from it completely, otherwise water may enter the cylinder through the exhaust port and cause engine trouble.
- Store the outboard motor in a dry, well-ventilated place, not in direct sunlight.

EMU28302

Procedure

EMU28313

Flushing in a water tank

1. Wash the outboard motor body using fresh water. For further information, see page 32.
2. Place the fuel cock in the closed position and disconnect the fuel line if equipped. Tighten the air vent screw, if equipped.
3. Remove the engine top cowling and silencer cover.
4. Install the outboard motor on the test tank.

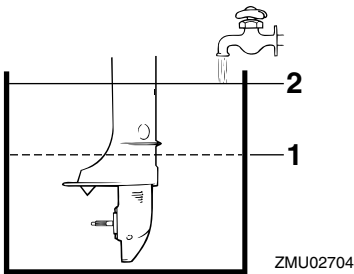

1. Lowest water level
 2. Water surface
5. Fill the tank with fresh water to above the level of the anti-cavitation plate.

ECM00290

CAUTION:

If the fresh water level is below the level of the anti-cavitation plate, or if the water supply is insufficient, engine seizure may occur.

6. Cooling system flushing is essential to prevent the cooling system from clogging up with salt, sand, or dirt. In addition, fogging/lubricating of the engine is mandatory to prevent excessive engine damage due to rust. Perform the flushing and fogging at the same time.

EWM00090

WARNING

- Do not touch or remove electrical parts when starting or during operation.
 - Keep hands, hair, and clothes away from the flywheel and other rotating parts while the engine is running.
7. Run the engine at a fast idle for a few minutes in neutral position.
 8. Just prior to turning off the engine, quickly spray "Fogging Oil" alternately into each carburetor or the fogging hole of the silencer cover, if equipped. When properly done, the engine will smoke excessively and almost stall.
 9. If "Fogging Oil" is not available, run the engine at a fast idle until the fuel system empties and the engine stops.
 10. Remove the outboard motor from the test tank.
 11. Install the silencer cover or fogging hole cap, and the top cowling.
 12. Drain the cooling water completely out of the motor. Clean the body thoroughly.

13. If "Fogging Oil" is not available, remove the spark plug(s). Pour a teaspoonful of clean engine oil into each cylinder. Crank several times manually. Replace the spark plug(s).
14. Drain the fuel from both the built-in and portable fuel tanks, on equipped models.

NOTE: _____
Portable fuel tank equipped models: Store the portable fuel tank in a dry, well-ventilated place, not in direct sunlight.

EMU28400

Lubrication (except oil injection models)

1. Grease the spark plug threads and install the spark plug(s) and torque to proper specification. For information on spark plug installation, see page 34.
2. Change the gear oil. For instructions, see page 38. Inspect the oil for the presence of water that indicates a leaky seal. Seal replacement should be performed by an authorized Yamaha dealer prior to use.
3. Grease all grease fittings. For further details, see page 34.

EMU28450

Cleaning the outboard motor

After use, wash the exterior of the outboard motor with fresh water. Flush the cooling system with fresh water.

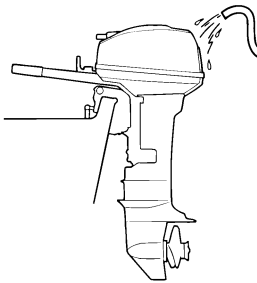

ZMU02459

NOTE: _____
For cooling system flushing instructions, see page 30.

EMU28460

Checking painted surface of motor

Check the motor for scratches, nicks, or flaking paint. Areas with damaged paint are more likely to corrode. If necessary, clean and paint the areas. A touch-up paint is available from your Yamaha dealer.

EMU28476

Periodic maintenance

EWM01070

WARNING

Be sure to turn off the engine when you perform maintenance unless otherwise specified. If you or the owner is not familiar with machine servicing, this work should be done by your Yamaha dealer or other qualified mechanic.

EMU28510

Replacement parts

If replacement parts are necessary, use only genuine Yamaha parts or parts of the same type and of equivalent strength and materials. Any part of inferior quality may malfunction, and the resulting loss of control could endanger the operator and passengers. Yamaha genuine parts and accessories are available from your Yamaha dealer.

Maintenance

EMU28522

Maintenance chart

Frequency of maintenance operations may be adjusted according to the operating conditions, but the following table gives general guidelines. Refer to the sections in this chapter for explanations of each owner-specific action.

NOTE:

When operating in salt water, turbid or muddy water, the engine should be flushed with clean water after each use.

The “●” symbol indicates the check-ups which you may carry out yourself.

The “○” symbol indicates work to be carried out by your Yamaha dealer.

Item	Actions	Initial		Every	
		10 hours (1 month)	50 hours (3 months)	100 hours (6 months)	200 hours (1 year)
Anode(s) (external)	Inspection / replacement		●/○	●/○	
Cooling water passages	Cleaning		●	●	
Cowling clamp	Inspection				●
Fuel filter (disposable)	Inspection / replacement	●/○	●/○	●/○	
Fuel filter (inside built-in fuel tank)	Inspection / cleaning				○
Fuel system	Inspection	●	●	●	
Fuel tank (built-in tank)	Inspection / cleaning				○
Fuel tank (Yamaha portable tank)	Inspection / cleaning				●
Gear oil	Change	●		●	
Greasing points	Greasing			●	
Idling speed (carburetor models)	Inspection	●/○		●/○	
Propeller and cotter pin	Inspection / replacement		●	●	
Shift link / shift cable	Inspection / adjustment				○
Thermostat	Inspection / replacement				○
Throttle link / throttle cable / throttle pick-up timing	Inspection / adjustment				○
Water pump	Inspection / replacement				○
Spark plug(s)	Cleaning / adjustment / replacement	●	●	●	

EMU28940

Greasing

Yamaha grease A (water resistant grease)

Yamaha grease D (corrosion resistant grease; for propeller shaft)

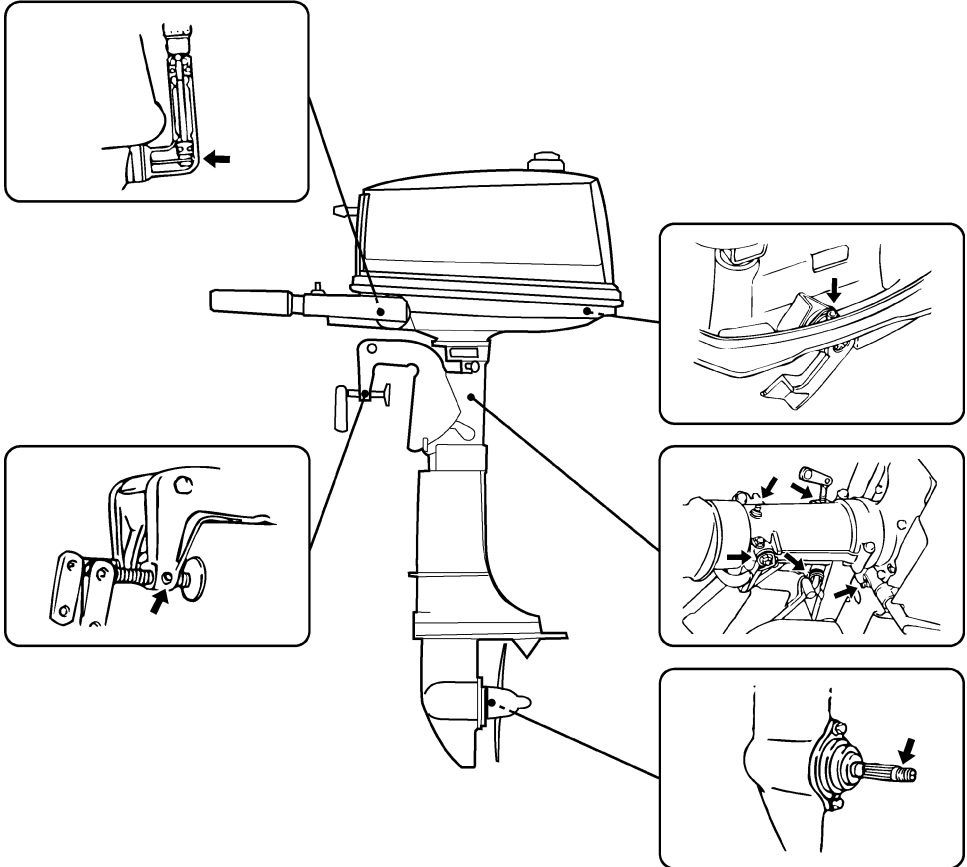

ZMU02797

EMU28952

Cleaning and adjusting spark plug

EWMM00560

WARNING

When removing or installing a spark plug, be careful not to damage the insulator. A damaged insulator could allow external sparks, which could lead to explosion or fire.

The spark plug is an important engine component and is easy to inspect. The condition of the spark plug can indicate something about the condition of the engine. For example, if the center electrode porcelain is very white, this could indicate an intake air leak or carburetion problem in that cylinder. Do not attempt to diagnose any problems yourself. Instead, take the outboard motor to a Yamaha dealer. You

Maintenance

should periodically remove and inspect the spark plug because heat and deposits will cause the spark plug to slowly break down and erode. If electrode erosion becomes excessive, or if carbon and other deposits are excessive, you should replace the spark plug with another of the correct type.

Standard spark plug:
BR7HS

Before fitting the spark plug, measure the electrode gap with a wire thickness gauge; adjust the gap to specification if necessary.

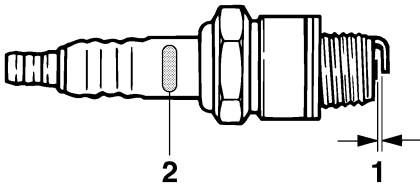

ZMU02179

1. Spark plug gap
2. Spark plug I.D. mark (NGK)

Spark plug gap:
0.6–0.7 mm (0.024–0.028 in)

When fitting the plug, always clean the gasket surface and use a new gasket. Wipe off any dirt from the threads and screw in the spark plug to the correct torque.

Spark plug torque:
25.0 Nm (18.4 ft-lb) (2.55 kgf-m)

NOTE:

If a torque-wrench is not available when you are fitting a spark plug, a good estimate of the correct torque is 1/4 to 1/2 a turn past finger-

tight. Have the spark plug adjusted to the correct torque as soon as possible with a torque-wrench.

EMU28962

Checking fuel system

EWM00060



Gasoline and its vapors are highly flammable and explosive. Keep away from sparks, cigarettes, flames, or other sources of ignition.

EWM00910



Leaking fuel can result in fire or explosion.

- Check for fuel leakage regularly.
- If any fuel leakage is found, the fuel system must be repaired by a qualified mechanic. Improper repairs can make the outboard unsafe to operate.

Check the fuel lines for leaks, crack, or malfunction. If a problem is found, your Yamaha dealer or other qualified mechanic should repair it immediately.

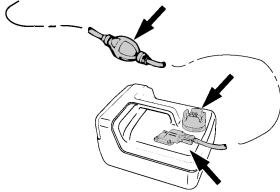
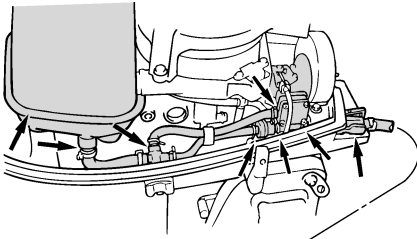

ZMU02798

Checkpoints

- Fuel system parts leakage
- Fuel line joint leakage
- Fuel line cracks or other damage
- Fuel connector leakage

EMU28990

Checking fuel filter

Check the fuel filter periodically. The fuel filter is a one piece, disposable type. If foreign matter is found in the filter, replace it. For replacement of the fuel filter, consult your Yamaha dealer.

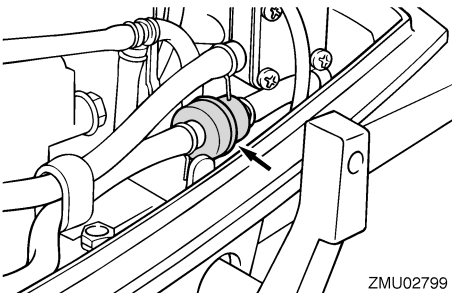

ZMU02799

EMU29041

Inspecting idling speed

EWM00451

WARNING

- Do not touch or remove electrical parts when starting or during operation.
- Keep hands, hair, and clothes away from the flywheel and other rotating parts while the engine is running.

ECM00490

CAUTION:

This procedure must be performed while the outboard motor is in the water. A flushing attachment or test tank can be used.

A diagnostic tachometer should be used for this procedure. Results may vary depending on whether testing is conducted with the flushing attachment, in a test tank, or with the outboard motor in the water.

1. Start the engine and allow it to warm up fully in neutral until it is running smoothly.

NOTE:

Correct idling speed inspection is only possible if the engine is fully warmed up. If not warmed up fully, the idle speed will measure higher than normal. If you have difficulty verifying the idle speed, or the idle speed requires adjustment, consult a Yamaha dealer or other qualified mechanic.

2. Verify whether the idle speed is set to specification. For idle speed specifications, see page 29.

EMU29112

Checking wiring and connectors

- Check that each grounding wire is properly secured.
- Check that each connector is engaged securely.

Maintenance

EMU29120

Exhaust leakage

Start the engine and check that no exhaust leaks from the joints between the exhaust cover, cylinder head, and body cylinder.

EMU29130

Water leakage

Start the engine and check that no water leaks from the joints between the exhaust cover, cylinder head, and body cylinder.

EMU29171

Checking propeller

EWM00321

WARNING

You could be seriously injured if the engine accidentally starts when you are near the propeller.

- Before inspecting, removing, or installing the propeller, remove the spark plug caps from the spark plugs. Also, place the shift control in neutral, turn the main switch to “OFF” (off) and remove the key, and remove the lanyard from the engine stop switch. Turn off the battery cut-off switch if your boat has one.
- Do not use your hand to hold the propeller when loosening or tightening the propeller nut. Put a wood block between the anti-cavitation plate and the propeller to prevent the propeller from turning.

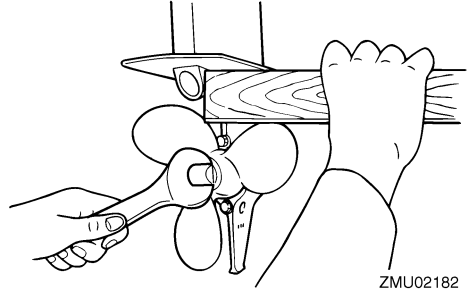

ZMU02182

Checkpoints

- Check each of the propeller blades for wear, erosion from cavitation or ventilation, or other damage.
- Check the propeller shaft for damage.
- Check the splines / shear pin for wear or damage.
- Check for fish line tangled around the propeller shaft.

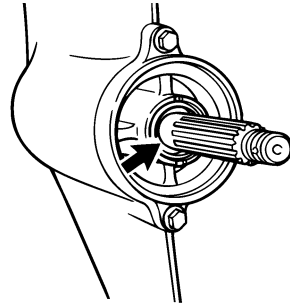

ZMU02274

- Check the propeller shaft oil seal for damage.

NOTE:

If the shear pin equipped: it is designed to break if the propeller hits a hard underwater obstacle to help protect the propeller and drive mechanism. The propeller will then spin freely on the shaft. If this happens, the shear pin must be replaced.

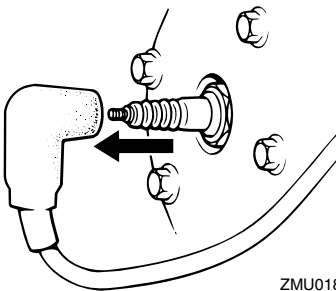

ZMU01896

EMU30660

Removing the propeller

EMU29194

Spline models

1. Straighten the cotter pin and pull it out using a pair of pliers.
2. Remove the propeller nut, washer, and spacer (if equipped).

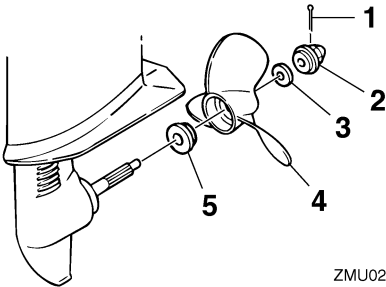

1. Cotter pin
2. Propeller nut
3. Washer
4. Propeller
5. Thrust washer

3. Remove the propeller and thrust washer.

EMU30670

Installing the Propeller

EMU30371

Spline models

ECM00340

CAUTION:

- Be sure to install the thrust washer before installing the propeller, otherwise the lower case and propeller boss could be damaged.
- Be sure to use a new cotter pin and bend the ends over securely. Otherwise the propeller could come off during operation and be lost.

1. Apply Yamaha marine grease or a corrosion resistant grease to the propeller shaft.

2. Install the spacer (if equipped), thrust washer, and propeller on the propeller shaft.
3. Install the spacer (if equipped) and the washer. Tighten the propeller nut until there is no forward-and-backward movement.
4. Align the propeller nut with the propeller shaft hole. Insert a new cotter pin in the hole and bend the cotter pin ends.

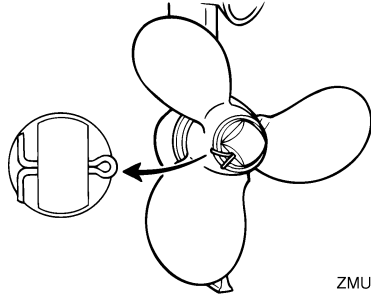

NOTE:

If the propeller nut does not align with the propeller shaft hole after tightening it, loosen the nut until it aligns with the hole.

EMU29282

Changing gear oil

EWM00800

WARNING

- Be sure the outboard motor is securely fastened to the transom or a stable stand. You could be severely injured if the outboard motor falls on you.
- Never get under the lower unit while it is tilted, even when the tilt support lever or knob is locked. Severe injury could occur if the outboard motor accidentally falls.

1. Tilt the outboard motor so that the gear oil drain screw is at the lowest point possible.

Maintenance

2. Place a suitable container under the gear case.
3. Remove the gear oil drain screw and gasket.

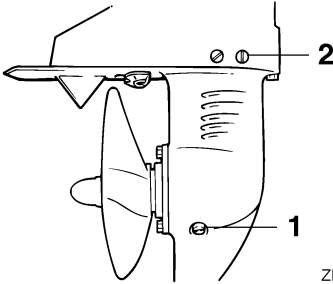

ZMU02754

1. Gear oil drain screw
2. Oil level plug

NOTE:

- If a magnetic gear oil drain screw is equipped, remove all metal particles from the screw before installing it.
- Always use new gaskets. Do not reuse the removed gaskets.

4. Remove the oil level plug and gasket to allow the oil to drain completely.

ECM00710

CAUTION:

Inspect the used oil after it has been drained. If the oil is milky, water is getting into the gear case which can cause gear damage. Consult a Yamaha dealer for repair of the lower unit seals.

NOTE:

For disposal of used oil, consult your Yamaha dealer.

5. With the outboard motor in a vertical position, and using a flexible or pressurized filling device, inject the gear oil into the gear oil drain screw hole.

Recommended gear oil:
Hypoid gear oil SAE#90
Gear oil quantity:
100.0 cm³ (3.38 US oz) (3.53 Imp.oz)

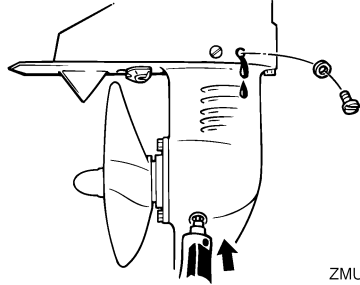

ZMU02755

6. Put a new gasket on the oil level plug. When the oil begins to flow out of the oil level plug hole, insert and tighten the oil level plug.
7. Put a new gasket on the gear oil drain screw. Insert and tighten the gear oil drain screw.

EMU29302

Cleaning fuel tank

EWM00920

WARNING

Gasoline is highly flammable, and its vapors are flammable and explosive.

- If you have any question about properly doing this procedure, consult your Yamaha dealer.
- Keep away from sparks, cigarettes, flames, or other sources of ignition when cleaning the fuel tank.
- Remove the fuel tank from the boat before cleaning it. Work only outdoors in an area with good ventilation.
- Wipe up any spilled fuel immediately.
- Reassemble the fuel tank carefully. Improper assembly can result in a fuel leak, which could result in a fire or explosion hazard.

● Dispose of old gasoline according to local regulations.

1. Empty the fuel tank into an approved container.
2. Pour a small amount of suitable solvent into the tank. Install the cap and shake the tank. Drain the solvent completely.
3. Remove the screws holding the fuel joint assembly. Pull the assembly out of the tank.

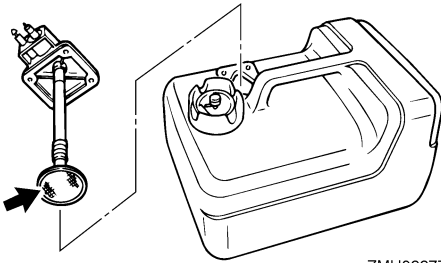

ZMU02277

4. Clean the filter (located on the end of the suction pipe) in a suitable cleaning solvent. Allow the filter to dry.
5. Replace the gasket with a new one. Reinstall the fuel joint assembly and tighten the screws firmly.

EMU29312

Inspecting and replacing anode(s)

Yamaha outboard motors are protected from corrosion by sacrificial anodes. Inspect the external anodes periodically. Remove scales from the surfaces of the anodes. Consult a Yamaha dealer for replacement of external anodes.

ECM00720

CAUTION:

Do not paint anodes, as this would render them ineffective.

NOTE:

Inspect ground leads attached to external anodes on equipped models. Consult a Yamaha dealer for inspection and replacement of internal anodes attached to the power unit.

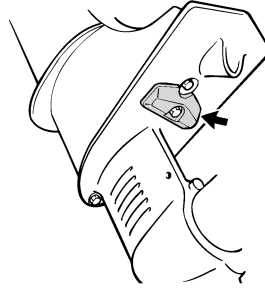

ZMU02803

EMU29390

Checking top cowling

Check the fitting of the top cowling by pushing it with both hands. If it is loose have it repaired by your Yamaha dealer.

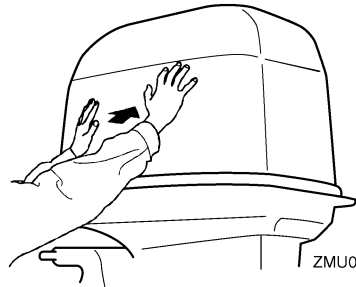

ZMU05175

EMU29400

Coating the boat bottom

A clean hull improves boat performance. The boat bottom should be kept as clean of marine growth as possible. If necessary, the boat bottom can be coated with an anti-fouling paint approved for your area to inhibit marine growth.

Do not use anti-fouling paint which includes copper or graphite. These paints can cause more rapid engine corrosion.

Maintenance

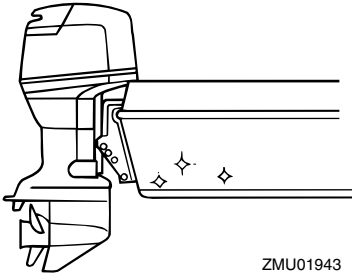

ZMU01943

EMU29424

Troubleshooting

A problem in the fuel, compression, or ignition systems can cause poor starting, loss of power, or other problems. This section describes basic checks and possible remedies, and covers all Yamaha outboard motors. Therefore some items may not apply to your model.

If your outboard motor requires repair, bring it to your Yamaha dealer.

If the engine trouble warning indicator is flashing, consult your Yamaha dealer.

Starter will not operate.

Q. Is battery capacity weak or low?

A. Check battery condition. Use battery of recommended capacity.

Q. Are battery connections loose or corroded?

A. Tighten battery cables and clean battery terminals.

Q. Is fuse for electric start relay or electric circuit blown?

A. Check for cause of electric overload and repair. Replace fuse with one of correct amperage.

Q. Are starter components faulty?

A. Have serviced by a Yamaha dealer.

Q. Is shift lever in gear?

A. Shift to neutral.

Engine will not start (starter operates).

Q. Is fuel tank empty?

A. Fill tank with clean, fresh fuel.

Q. Is fuel contaminated or stale?

A. Fill tank with clean, fresh fuel.

Q. Is fuel filter clogged?

A. Clean or replace filter.

Q. Is starting procedure incorrect?

A. See page 19.

Q. Has fuel pump malfunctioned?

A. Have serviced by a Yamaha dealer.

Q. Are spark plug(s) fouled or of incorrect type?

A. Inspect spark plug(s). Clean or replace with recommended type.

Q. Are spark plug cap(s) fitted incorrectly?

A. Check and re-fit cap(s).

Q. Is ignition wiring damaged or poorly connected?

A. Check wires for wear or breaks. Tighten all loose connections. Replace worn or broken wires.

Q. Are ignition parts faulty?

A. Have serviced by a Yamaha dealer.

Q. Is engine stop switch lanyard not attached?

A. Attach lanyard.

Q. Are engine inner parts damaged?

A. Have serviced by a Yamaha dealer.

Engine idles irregularly or stalls.

Q. Are spark plug(s) fouled or of incorrect type?

A. Inspect spark plug(s). Clean or replace with recommended type.

Q. Is fuel system obstructed?

Trouble Recovery

A. Check for pinched or kinked fuel line or other obstructions in fuel system.

Q. Is fuel contaminated or stale?

A. Fill tank with clean, fresh fuel.

Q. Is fuel filter clogged?

A. Clean or replace filter.

Q. Have ignition parts failed?

A. Have serviced by a Yamaha dealer.

Q. Has warning system activated?

A. Find and correct cause of warning.

Q. Is spark plug gap incorrect?

A. Inspect and adjust as specified.

Q. Is ignition wiring damaged or poorly connected?

A. Check wires for wear or breaks. Tighten all loose connections. Replace worn or broken wires.

Q. Is specified engine oil not being used?

A. Check and replace oil as specified.

Q. Is thermostat faulty or clogged?

A. Have serviced by a Yamaha dealer.

Q. Are carburetor adjustments incorrect?

A. Have serviced by a Yamaha dealer.

Q. Is fuel pump damaged?

A. Have serviced by a Yamaha dealer.

Q. Is air vent screw on fuel tank closed?

A. Open air vent screw.

Q. Is choke knob pulled out?

A. Return to home position.

Q. Is motor angle too high?

A. Return to normal operating position.

Q. Is carburetor clogged?

A. Have serviced by a Yamaha dealer.

Q. Is fuel joint connection incorrect?

A. Connect correctly.

Q. Is throttle valve adjustment incorrect?

A. Have serviced by a Yamaha dealer.

Q. Is battery cable disconnected?

A. Connect securely.

Warning buzzer sounds or indicator lights.

Q. Is cooling system clogged?

A. Check water intake for restriction.

Q. Is engine oil level low?

A. Fill oil tank with specified engine oil.

Q. Is heat range of spark plug incorrect?

A. Inspect spark plug and replace it with recommended type.

Q. Is specified engine oil not being used?

A. Check and replace oil with specified type.

Q. Is engine oil contaminated or deteriorated?

A. Replace oil with fresh, specified type.

Q. Is oil filter clogged?

A. Have serviced by a Yamaha dealer.

Q. Has oil feed/injection pump malfunctioned?

A. Have serviced by a Yamaha dealer.

Trouble Recovery

Q. Is load on boat improperly distributed?

A. Distribute load to place boat on an even plane.

Q. Is water pump or thermostat faulty?

A. Have serviced by a Yamaha dealer.

Q. Is there excess water in fuel filter cup?

A. Drain filter cup.

Engine power loss.

Q. Is propeller damaged?

A. Have propeller repaired or replaced.

Q. Is propeller pitch or diameter incorrect?

A. Install correct propeller to operate outboard at its recommended speed (r/min) range.

Q. Is trim angle incorrect?

A. Adjust trim angle to achieve most efficient operation.

Q. Is motor mounted at incorrect height on transom?

A. Have motor adjusted to proper transom height.

Q. Has warning system activated?

A. Find and correct cause of warning.

Q. Is boat bottom fouled with marine growth?

A. Clean boat bottom.

Q. Are spark plug(s) fouled or of incorrect type?

A. Inspect spark plug(s). Clean or replace with recommended type.

Q. Are weeds or other foreign matter tangled on gear housing?

A. Remove foreign matter and clean lower unit.

Q. Is fuel system obstructed?

A. Check for pinched or kinked fuel line or other obstructions in fuel system.

Q. Is fuel filter clogged?

A. Clean or replace filter.

Q. Is fuel contaminated or stale?

A. Fill tank with clean, fresh fuel.

Q. Is spark plug gap incorrect?

A. Inspect and adjust as specified.

Q. Is ignition wiring damaged or poorly connected?

A. Check wires for wear or breaks. Tighten all loose connections. Replace worn or broken wires.

Q. Have electrical parts failed?

A. Have serviced by a Yamaha dealer.

Q. Is specified fuel not being used?

A. Replace fuel with specified type.

Q. Is specified engine oil not being used?

A. Check and replace oil with specified type.

Q. Is thermostat faulty or clogged?

A. Have serviced by a Yamaha dealer.

Q. Is air vent screw closed?

A. Open the air vent screw.

Q. Is fuel pump damaged?

A. Have serviced by a Yamaha dealer.

Q. Is fuel joint connection incorrect?

Trouble Recovery

A. Connect correctly.

Q. Is heat range of spark plug incorrect?

A. Inspect spark plug and replace it with recommended type.

Q. Is high pressure fuel pump drive belt broken?

A. Have serviced by a Yamaha dealer.

Q. Is engine not responding properly to shift lever position?

A. Have serviced by a Yamaha dealer.

Engine vibrates excessively.

Q. Is propeller damaged?

A. Have propeller repaired or replaced.

Q. Is propeller shaft damaged?

A. Have serviced by a Yamaha dealer.

Q. Are weeds or other foreign matter tangled on propeller?

A. Remove and clean propeller.

Q. Is motor mounting bolt loose?

A. Tighten bolt.

Q. Is steering pivot loose or damaged?

A. Tighten or have serviced by a Yamaha dealer.

EMU29432

Temporary action in emergency

EMU29440

Impact damage

EWM00870

WARNING

The outboard motor can be seriously damaged by a collision while operating or trailering. Damage could make the outboard motor unsafe to operate.

If the outboard motor hits an object in the water, follow the procedure below.



1. Stop the engine immediately.
2. Inspect the control system and all components for damage. Also inspect the boat for damage.
3. Whether damage is found or not, return to the nearest harbor slowly and carefully.
4. Have a Yamaha dealer inspect the outboard motor before operating it again.

EMU29532

Starter will not operate

If the starter mechanism does not operate (the engine cannot be cranked with the starter), the engine can be started with an emergency starter rope.

EWM01021

WARNING

- Use this procedure only in an emergency to return to the nearest port for repairs.
- When the emergency starter rope is used to start the engine, the start-in-gear protection device does not operate. Make sure the remote control lever is in neutral. Otherwise the boat could unexpectedly start to move, which could result in an accident.
- Attach the engine stop switch lanyard to a secure place on your clothing, or your arm or leg while operating the boat.

Trouble Recovery

- Do not attach the lanyard to clothing that could tear loose. Do not route the cord where it could become entangled, preventing it from functioning.
- Avoid accidentally pulling the lanyard during normal operation. Loss of engine power means the loss of most steering control. Also, without engine power, the boat could slow rapidly. This could cause people and objects in the boat to be thrown forward.
- Make sure no one is standing behind you when pulling the starter rope. It could whip behind you and injure someone.
- An unguarded, rotating flywheel is very dangerous. Keep loose clothing and other objects away when starting the engine. Use the emergency starter rope only as instructed. Do not touch the flywheel or other moving parts when the engine is running. Do not install the starter mechanism or top cowling after the engine is running.
- Do not touch the ignition coil, spark plug wire, spark plug cap, or other electrical components when starting or operating the motor. You could get an electrical shock.

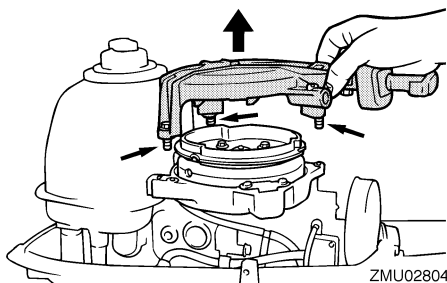

4. Prepare the engine for starting. For further information, see page 19. Be sure the engine is in neutral and that the engine stop switch lanyard lock plate is attached to the engine stop switch. The main switch must be "ON" (on), if equipped.
5. If equipped the choke knob, pull out it when the engine is cold. After the engine starts, gradually return the choke knob to its home position as the engine warms up.
6. Insert the knotted end of the emergency starter rope into the notch in the flywheel rotor and wind the rope several turns around the flywheel clockwise.
7. Give a strong pull straight out to crank and start the engine. Repeat if necessary.

EMU29561

Emergency starting engine

1. Remove the top cowling.
2. Remove the start-in-gear protection cable from the starter, if equipped.
3. Remove the starter/flywheel cover after removing the bolt(s).

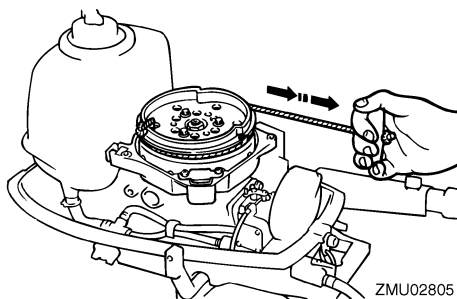

Trouble Recovery

EMU29760

Treatment of submerged motor

If the outboard motor is submerged, immediately take it to a Yamaha dealer. Otherwise some corrosion may begin almost immediately.

If you cannot immediately take the outboard motor to a Yamaha dealer, follow the procedure below in order to minimize engine damage.

EMU29771

Procedure

1. Thoroughly wash away mud, salt, seaweed, and so on, with fresh water.



ZMU01909

2. Remove the spark plugs and face the spark plug holes downward to allow any water, mud, or contaminants to drain.

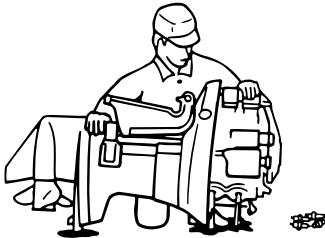

ZMU01910

3. Drain the fuel from the carburetor, fuel filter, and fuel line.

4. Feed fogging oil or engine oil through the carburetor(s) and spark plug holes while cranking with the manual starter or emergency starter rope.

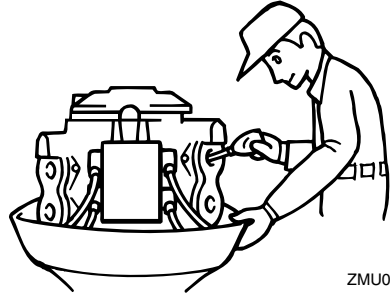

ZMU01911

5. Take the outboard motor to a Yamaha dealer as soon as possible.

ECM00400

CAUTION:

Do not attempt to run the outboard motor until it has been completely inspected.



YAMAHA

YAMAHA MOTOR CO., LTD.

Printed in Japan

April 2006-3.0 × 1 CR

Printed on recycled paper