

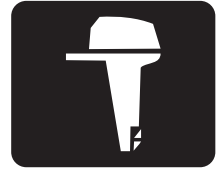

YAMAHA



**F115A
FL115A**

OWNER'S MANUAL

68V-28199-78-E0

EMU25051



Read this owner's manual carefully before operating or working on your outboard motor. Keep this manual onboard in a waterproof bag when boating. This manual should stay with the outboard motor if it is sold.

Important manual information

EMU25103

To the owner

Thank you for choosing a Yamaha outboard motor. This Owner's Manual contains information needed for proper operation, maintenance and care. A thorough understanding of these simple instructions will help you obtain maximum enjoyment from your new Yamaha. If you have any question about the operation or maintenance of your outboard motor, please consult a Yamaha dealer.

In this Owner's Manual particularly important information is distinguished in the following ways.



The Safety Alert Symbol means **ATTENTION! BECOME ALERT! YOUR SAFETY IS INVOLVED!**

EWM00780



WARNING

Failure to follow WARNING instructions could result in severe injury or death to the machine operator, a bystander, or a person inspecting or repairing the outboard motor.

ECM00700

CAUTION:

A CAUTION indicates special precautions that must be taken to avoid damage to the outboard motor.

NOTE:

A NOTE provides key information to make procedures easier or clearer.

Yamaha continually seeks advancements in product design and quality. Therefore, while this manual contains the most current product information available at the time of printing, there may be minor discrepancies between your machine and this manual. If there is any question concerning this manu-

al, please consult your Yamaha dealer.

To ensure long product life, Yamaha recommends that you use the product and perform the specified periodic inspections and maintenance by correctly following the instructions in the owner's manual. Any damage resulting from neglect of these instructions is not covered by warranty.

Some countries have laws or regulations restricting users from taking the product out of the country where it was purchased, and it may be impossible to register the product in the destination country. Additionally, the warranty may not apply in certain regions. When planning to take the product to another country, consult the dealer where the product was purchased for further information.

If the product was purchased used, please consult your closest dealer for customer re-registration, and to be eligible for the specified services.

NOTE:

The F115AET, FL115AET and the standard accessories are used as a base for the explanations and illustrations in this manual. Therefore some items may not apply to every model.

EMU25121

F115A, FL115A OWNER'S MANUAL

**©2007 by Yamaha Motor Co., Ltd.
1st Edition, April 2007**

All rights reserved.

**Any reprinting or unauthorized use
without the written permission of
Yamaha Motor Co., Ltd.
is expressly prohibited.**

Printed in Japan

Table of contents

General information	1	Neutral interlock trigger	14
Identification numbers record	1	Neutral throttle lever	14
Outboard motor serial number	1	Free accelerator	15
Key number.....	1	Tiller handle.....	15
EC label.....	1	Gear shift lever.....	15
Read manuals and labels.....	3	Throttle grip	16
Warning labels	3	Throttle indicator	16
Safety information.....	6	Throttle friction adjuster.....	16
Safety information	6	Engine shut-off switch	17
Rotating parts.....	6	Engine stop button	18
Hot parts	6	Main switch	18
Electric shock.....	6	Steering friction adjuster	18
Power trim and tilt	6	Power trim and tilt switch on	
Engine shut-off cord.....	6	remote control or tiller handle	19
Gasoline.....	6	Power trim and tilt switch on	
Gasoline exposure and spills	6	bottom engine cowling	19
Carbon monoxide.....	7	Power trim and tilt switches (twin	
Modifications	7	binnacle type).....	20
Boating safety	7	Trim tab with anode.....	20
Alcohol and drugs	7	Tilt support lever for power trim	
Personal flotation devices	7	and tilt model.....	21
People in the water	7	Top cowling lock lever (pull up	
Passengers	7	type).....	21
Overloading.....	7	Flushing device	22
Avoid collisions	7	Fuel filter/Water separator.....	22
Weather	8	Warning indicator	22
Passenger training	8	Digital tachometer	22
Boating safety publications	8	Low oil pressure-warning	
Laws and regulations	8	indicator	23
Basic requirements.....	9	Overheat-warning indicator (digital	
Fueling instructions	9	type).....	23
Gasoline.....	9	Speedometer (digital type)	24
Engine oil	9	Trim meter (digital type)	24
Installation requirements	10	Hour meter (digital type).....	24
Boat horsepower rating.....	10	Trip meter.....	25
Mounting motor	10	Clock	25
Remote control requirements.....	10	Fuel gauge	26
Battery requirement	10	Fuel warning indicator	26
Propeller selection	11	Low battery voltage-warning	
Start-in-gear protection	11	indicator	26
Basic components	12	Fuel management meter	27
Main components.....	12	Fuel flow meter.....	27
Remote control.....	13	Fuel consumption meter.....	28
Remote control lever.....	14	Fuel economy.....	28
		Twin-engine speed synchronizer	28

Table of contents

6Y8 Multifunction meters	29	motor	57
Tachometer unit	29	Storing outboard motor	58
Speed & fuel meter unit	33	Procedure.....	58
Speedometer unit.....	34	Lubrication.....	59
Fuel management meter.....	34	Battery care.....	60
Warning system	35	Flushing power unit	60
Overheat warning (twin engines)	35	Cleaning the outboard motor.....	61
Low oil pressure warning	36	Checking painted surface of	
Operation	38	motor.....	61
Installation	38	Periodic maintenance	62
Mounting the outboard motor.....	38	Replacement parts	62
Breaking in engine	39	Severe operating conditions.....	62
Procedure for 4-stroke models.....	39	Maintenance chart 1.....	63
Pre-operation checks	40	Maintenance chart 2.....	65
Fuel.....	40	Greasing.....	66
Controls.....	40	Cleaning and adjusting spark	
Stop switches.....	40	plug	66
Engine	40	Checking fuel system	67
Checking the engine oil level	40	Inspecting idling speed.....	68
Filling fuel	41	Changing engine oil	68
Operating engine.....	41	Checking wiring and connectors	70
Feeding fuel	41	Exhaust leakage.....	70
Starting engine	42	Water leakage	70
Warming up engine	45	Engine oil leakage.....	70
Manual start and electric start		Checking power trim and tilt	
models	45	system.....	70
Shifting	45	Checking propeller	71
Stopping boat	47	Removing propeller	72
Stopping engine	47	Installing propeller	72
Procedure	47	Changing gear oil.....	73
Trimming outboard motor.....	48	Inspecting and replacing	
Adjusting trim angle (Power trim		anode(s).....	74
and tilt)	48	Checking battery (for electric start	
Adjusting boat trim	50	models)	75
Tilting up and down	50	Connecting the battery	75
Procedure for tilting up (power trim		Disconnecting the battery.....	76
and tilt models)	51	Checking top cowling	76
Procedure for tilting down (power		Coating the boat bottom	76
trim and tilt models)	53	Trouble Recovery.....	78
Cruising in shallow water	53	Troubleshooting	78
Power trim and tilt models.....	53	Temporary action in emergency ...	81
Cruising in other conditions	55	Impact damage	81
Maintenance.....	56	Running single engine.....	81
Specifications	56	Replacing fuse	82
Transporting and storing outboard		Power trim and tilt will not	

Table of contents

operate.....	82
Water separator-warning indicator blinks while cruising	83
Starter will not operate	84
Emergency starting engine	85
Treatment of submerged motor.....	86

EMU25170

Identification numbers record

--	--	--	--

EMU25183

Outboard motor serial number

The outboard motor serial number is stamped on the label attached to the port side of the clamp bracket.

Record your outboard motor serial number in the spaces provided to assist you in ordering spare parts from your Yamaha dealer or for reference in case your outboard motor is stolen.

ZMU01693

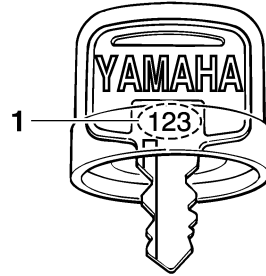

ZMU01694

1. Key number

EMU25202

EC label

Engines affixed with this label conform to certain portions of the European Parliament directive relating to machinery. Refer to the label and the EC Declaration of Conformity for more details.

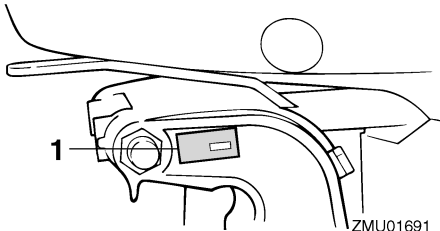

ZMU01691

1. Outboard motor serial number location

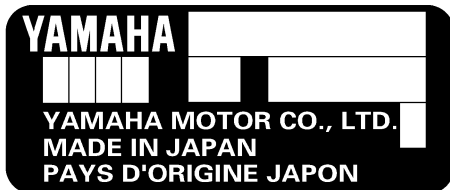

ZMU01692

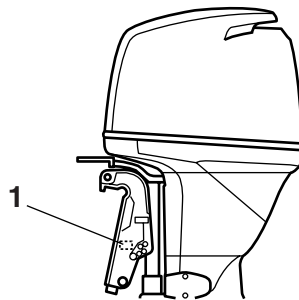

ZMU04273

1. EC label location

EMU25190

Key number

If a main key switch is equipped with the motor, the key identification number is stamped on your key as shown in the illustration. Record this number in the space provided for reference in case you need a new key.

General information

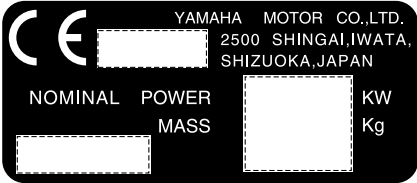

ZMU01696

EMU33520

Read manuals and labels

Before operating or working on this motor:

- Read this manual.
- Read any manuals supplied with the boat.
- Read all labels on the outboard motor and the boat.

If you need any additional information, contact your Yamaha dealer.

EMU33830

Warning labels

If these labels are damaged or missing, contact your Yamaha dealer for replacements.

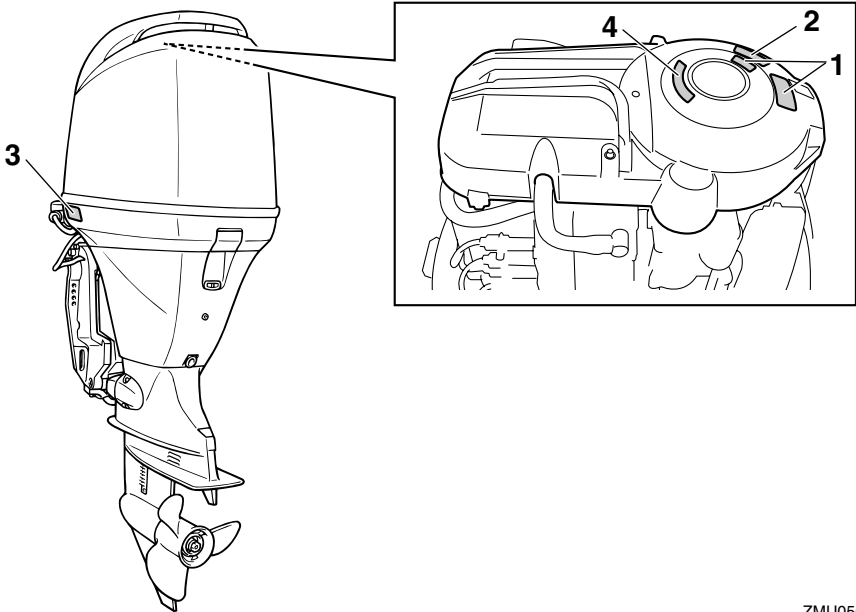

ZMU05693

General information

1

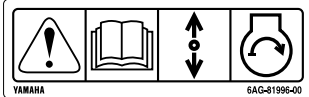

2



3

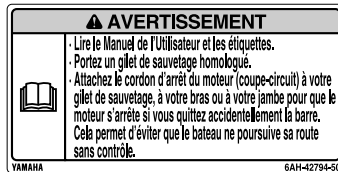
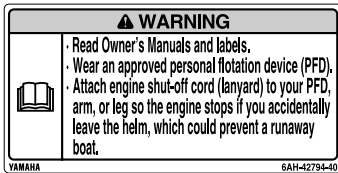

4

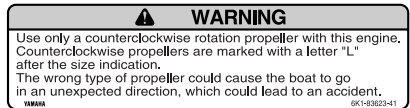

ZMU05731

EMU34661

Contents of labels

The above warning labels mean as follows.

1

EWMO1691

⚠ WARNING _____
Emergency starting does not have start-in-gear protection. Ensure shift control is in neutral before starting engine.

2

EWMO1681

⚠ WARNING _____

- Keep hands, hair, and clothing away from rotating parts while the engine is running.
- Do not touch or remove electrical parts when starting or during operation.

3

EWMO1671

⚠ WARNING _____

- Read Owner's Manuals and labels.
- Wear an approved personal flotation device (PFD).
- Attach engine shut-off cord (lanyard) to your PFD, arm, or leg so the engine stops if you accidentally leave the helm, which could prevent a runaway boat.

4

EWMO1282

⚠ WARNING _____
Use only a counterclockwise rotation propeller with this engine. Counterclockwise propellers are marked

General information

with a letter “L” after the size indication.
The wrong type of propeller could cause the boat to go in an unexpected direction, which could lead to an accident.

EMU33841

Symbols

The following symbols mean as follows.

Caution/Warning



ZMU05696

Read Operator's Manual



ZMU05664

Hazard caused by continuous rotation

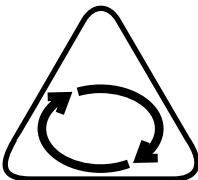

ZMU05665

Electrical hazard

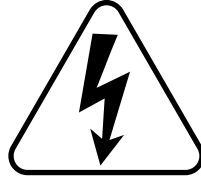

ZMU05666

Remote control lever/gear shift lever operating direction, dual direction



ZMU05667

Engine start/ Engine cranking

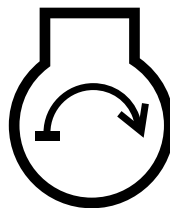

ZMU05668

Safety information

EMU33620

Safety information

Observe these precautions at all times.

EMU33630

Rotating parts

Hands, feet, hair, jewelry, clothing, PFD straps, etc. can become entangled with internal rotating parts of the engine, resulting in serious injury or death.

Keep the top cowling in place whenever possible. Do not remove or replace the cowling with the engine running.

Only operate the engine with the cowling removed according to the specific instructions in the manual. Keep hands, feet, hair, jewelry, clothing, PFD straps, etc. away from any exposed moving parts.

EMU33640

Hot parts

During and after operation, engine parts are hot enough to cause burns. Avoid touching any parts under the top cowling until the engine has cooled.

EMU33650

Electric shock

Do not touch any electrical parts while starting or operating the engine. They can cause shock or electrocution.

EMU33660

Power trim and tilt

Body parts can be crushed between the motor and the clamp bracket when the motor is trimmed or tilted. Keep body parts out of this area at all times. Be sure no one is in this area before operating the power trim and tilt mechanism.

The power trim and tilt switches operate even when the main switch is off. Keep people be away from the switches whenever working around the motor.

Never get under the lower unit while it is tilted, even when the tilt support lever is locked.

Severe injury could occur if the outboard motor accidentally falls.

EMU33670

Engine shut-off cord

Attach the engine shut-off cord so that the engine stops if the operator falls overboard or leaves the helm. This prevents the boat from running away under power and leaving people stranded, or running over people or objects.

Always attach the engine shut-off cord to a secure place on your clothing or your arm or leg while operating. Do not remove it to leave the helm while the boat is moving. Do not attach the cord to clothing that could tear loose, or route the cord where it could become entangled, preventing it from functioning.

Do not route the cord where it is likely to be accidentally pulled out. If the cord is pulled during operation, the engine will shut off and you will lose most steering control. The boat could slow rapidly, throwing people and objects forward.

EMU33810

Gasoline

Gasoline and its vapors are highly flammable and explosive. Always, refuel according to the procedure on page 41 to reduce the risk of fire and explosion.

EMU33820

Gasoline exposure and spills

Take care not to spill gasoline. If gasoline spills, wipe it up immediately with dry rags. Dispose of rags properly.

If any gasoline spills onto your skin, immediately wash with soap and water. Change clothing if gasoline spills on it.

If you swallow gasoline, inhale a lot of gasoline vapor, or get gasoline in your eyes, get immediate medical attention. Never siphon fuel by mouth.

EMU33900

Carbon monoxide

This product emits exhaust gases which contain carbon monoxide, a colorless, odorless gas which may cause brain damage or death when inhaled. Symptoms include nausea, dizziness, and drowsiness. Keep cockpit and cabin areas well ventilated. Avoid blocking exhaust outlets.

EMU33780

Modifications

Do not attempt to modify this outboard motor. Modifications to your outboard motor may reduce safety and reliability, and render the outboard unsafe or illegal to use.

EMU33740

Boating safety

This section includes a few of the many important safety precautions that you should follow when boating.

EMU33710

Alcohol and drugs

Never operate after drinking alcohol or taking drugs. Intoxication is one of the most common factors contributing to boating fatalities.

EMU33720

Personal flotation devices

Have an approved personal flotation device (PFD) on board for every occupant. Yamaha recommends that you must wear a PFD whenever boating. At a minimum, children and non-swimmers should always wear PFDs, and everyone should wear PFDs when there are potentially hazardous boating conditions.

EMU33730

People in the water

Always watch carefully for people in the water, such as swimmers, skiers, or divers, whenever the engine is running. When someone is in the water near the boat, shift

into neutral and shut off the motor.

Stay away from swimming areas. Swimmers can be hard to see.

The propeller can keep moving even when the motor is in neutral. Shut off the engine when a person is in the water near you.

EMU33750

Passengers

Consult your boat manufacturer's instructions for details about appropriate passenger locations in your boat and be sure all passengers are positioned properly before accelerating and when operating above an idle speed. Standing or sitting in non-designated locations may result in being thrown either overboard or within the boat due to waves, wakes, or sudden changes in speed or direction. Even when people are positioned properly, alert your passengers if you must make any unusual maneuver. Always avoid jumping waves or wakes.

EMU33760

Overloading

Do not overload the boat. Consult the boat capacity plate or boat manufacturer for maximum weight and number of passengers. Be sure that weight is properly distributed according to the boat manufacturer's instructions. Overloading or incorrect weight distribution can compromise the boat's handling and lead to an accident, capsizing or swamping.

EMU33770

Avoid collisions

Scan constantly for people, objects, and other boats. Be alert for conditions that limit your visibility or block your vision of others.

Operate defensively at safe speeds and keep a safe distance away from people, objects, and other boats.

- Do not follow directly behind other boats or waterskiers.

Safety information

- Avoid sharp turns or other maneuvers that make it hard for others to avoid you or understand where you are going.
- Avoid areas with submerged objects or shallow water.
- Ride within your limits and avoid aggressive maneuvers to reduce the risk of loss of control, ejection, and collision.
- **Take early action** to avoid collisions. Remember, **boats do not have brakes**, and stopping the engine or reducing throttle can reduce the ability to steer. If you are not sure that you can stop in time before hitting an obstacle, apply throttle and turn in another direction.

EMU33790

Weather

Stay informed about the weather. Check weather forecasts before boating. Avoid boating in hazardous weather.

EMU33880

Passenger training

Make sure at least one other passenger is trained to operate the boat in the event of an emergency.

EMU33890

Boating safety publications

Be informed about boating safety. Additional publications and information can be obtained from many boating organizations.

EMU33600

Laws and regulations

Know the marine laws and regulations where you will be boating- and obey them. Several sets of rules prevail according to geographic location, but all are basically the same as the International Rules of the Road.

EMU25540

Fueling instructions

EWM00010

WARNING

GASOLINE AND ITS VAPORS ARE HIGHLY FLAMMABLE AND EXPLOSIVE!

- Do not smoke when refueling, and keep away from sparks, flames, or other sources of ignition.
- Stop engine before refueling.
- Refuel in a well-ventilated area. Refuel portable fuel tanks off the boat.
- Take care not to spill gasoline. If gasoline spills, wipe it up immediately with dry rags.
- Do not overfill the fuel tank.
- Tighten the filler cap securely after refueling.
- If you should swallow some gasoline, inhale a lot of gasoline vapor, or get gasoline in your eyes, get immediate medical attention.
- If any gasoline spills onto your skin, immediately wash with soap and water. Change clothing if gasoline spills on it.
- Touch the fuel nozzle to the filler opening or funnel to help prevent electrostatic sparks.

ECM00010

CAUTION:

Use only new clean gasoline which has been stored in clean containers and is not contaminated with water or foreign matter.

EMU25580

Gasoline

Recommended gasoline:

Regular unleaded gasoline with a minimum octane rating of 90 (Research Octane Number).

If knocking or pinging occurs, use a different brand of gasoline or premium unleaded fuel.

EMU25683

Engine oil

Recommended engine oil:

4-stroke motor oil with a combination of the following SAE and API oil classifications

Engine oil type SAE:

10W-30 or 10W-40

Engine oil grade API:

SE, SF, SG, SH, SJ, SL

Engine oil quantity (excluding oil filter):

4.3 L (4.55 US qt) (3.78 Imp.qt)

NOTE:

If the recommended engine oil grades are not available, select an alternative from the following chart according to the average temperatures in your area.

Basic requirements

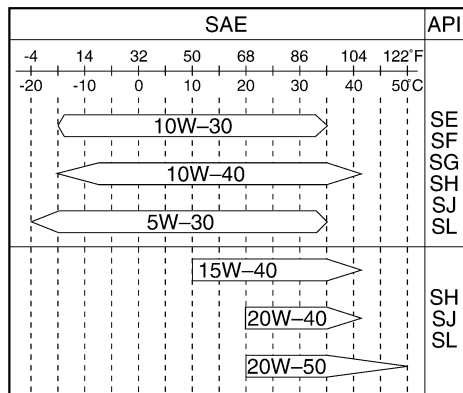

ZMU05190

ECM01050

CAUTION:

All 4-stroke engines are shipped from the factory without engine oil.



ZMU01710

EMU33550

Installation requirements

EMU33560

Boat horsepower rating

Before installing the outboard motor(s), confirm that the total horsepower of your motor(s) does not exceed the boats maximum horsepower rating. See the boats capacity plate or contact the manufacturer.

EWM01560

WARNING

Overpowering a boat can cause severe

instability.

EMU33570

Mounting motor

Your dealer or other person experienced in proper rigging should mount the motor using correct equipment and complete rigging instructions. For further information, see page 38.

EWM01570

WARNING

- Improper mounting of the outboard motor could result in hazardous conditions such as poor handling, loss of control, or fire hazards.
- Because the motor is very heavy, special equipment and training is required to mount it safely.

EMU33580

Remote control requirements

The remote control unit must be equipped with a start-in-gear protection device(s). This device prevents the engine from starting unless it is in neutral.

EWM01580

WARNING

- If the engine starts in gear, the boat can move suddenly and unexpectedly, possibly causing a collision or throwing passengers overboard.
- If the engine ever starts in gear, the start-in-gear protection device is not working correctly and you should discontinue using the outboard. Contact your Yamaha dealer.

EMU25702

Battery requirement

ECM01061

CAUTION:

Do not use a battery that does not meet the specified capacity. If a battery that does not meet specifications is used, the

Basic requirements

electric system could perform poorly or be overloaded, causing electric system damage.

For electric start models, choose a battery which meets the following specifications.

EMU25721

Battery specifications

Minimum cold cranking amps (CCA/EN): 430.0 A
Minimum rated capacity (20HR/IEC): 70.0 Ah

The engine cannot be started if battery voltage is too low.

EMU34190

Propeller selection

Next to selecting an outboard, choosing the right propeller is one of the most important purchasing decisions a boater can make. The type, size, and design of your propeller have a direct impact on acceleration, top speed, fuel economy, and even engine life. Yamaha designs and manufactures propellers for every Yamaha outboard motor and every application.

Your outboard motor came with a Yamaha propeller chosen to perform well over a range of applications, but there may be uses where a different propeller would be more appropriate.

Your Yamaha dealer can help you select the right propeller for your boating needs. Select a propeller that will allow the engine to reach the middle or upper half of the operating range at full throttle with the maximum boatload. Generally, choose a larger pitch propeller for a smaller operating load and a smaller pitch propeller for a heavier load. If you carry loads that vary widely, choose the propeller that lets the engine run in the proper range for your maximum load but remember that

you may need to reduce your throttle setting to stay within the recommended engine speed range when carrying lighter loads.

For instructions on propeller removal and installation, see page 71.

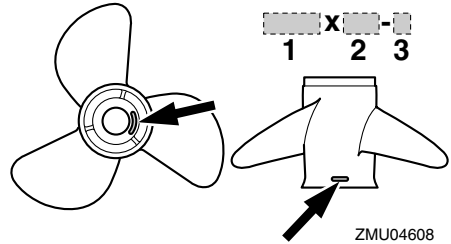

1. Propeller diameter in inches
2. Propeller pitch in inches
3. Type of propeller (propeller mark)

EMU25770

Start-in-gear protection

Yamaha outboard motors or Yamaha-approved remote control units are equipped with start-in-gear protection device(s). This feature permits the engine to be started only when it is in neutral. Always select neutral before starting the engine.

Basic components

EMU2579B

Main components

NOTE:

* May not be exactly as shown; also may not be included as standard equipment on all models.

F115A, FL115A

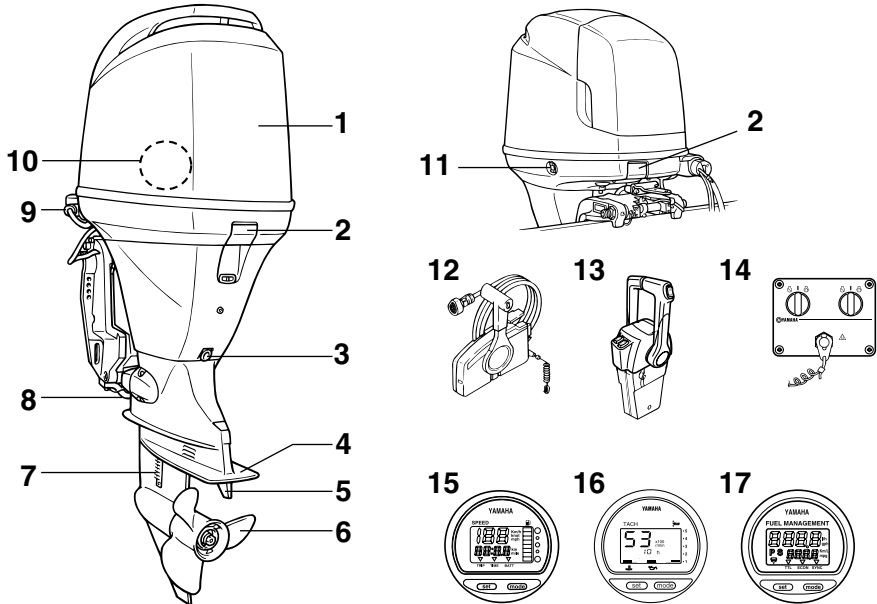

ZMU04775

1. Top cowling
2. Top cowling lock lever(s)
3. Drain screw
4. Anti-cavitation plate
5. Trim tab (anode)
6. Propeller*
7. Cooling water inlet
8. Anode
9. Flushing device
10. Water separator
11. Power trim and tilt switch
12. Remote control box (side mount type)*
13. Remote control box (binnacle mount type)*
14. Switch panel (for use with binnacle type)*

15. Digital speedometer*
16. Digital tachometer
17. Fuel management meter*

Basic components

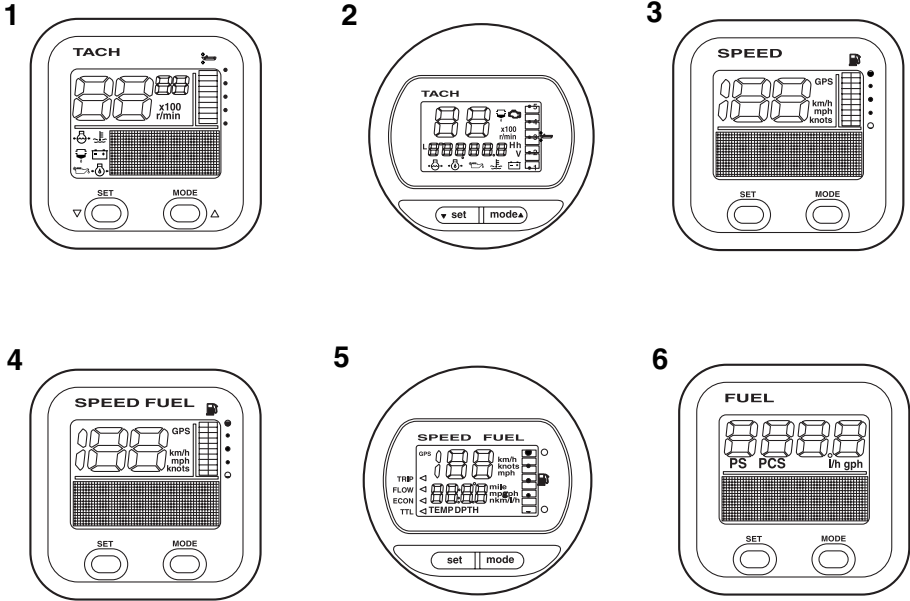

ZMU05429

1. Tachometer unit (Square type)*
2. Tachometer unit (Round type)*
3. Speedometer unit (Square type)*
4. Speed & fuel meter unit (Square type)*
5. Speed & fuel meter unit (Round type)*
6. Fuel management meter (Square type)*

EMU26180

Remote control

The remote control lever actuates both the shifter and the throttle. The electrical switches are mounted on the remote control box.

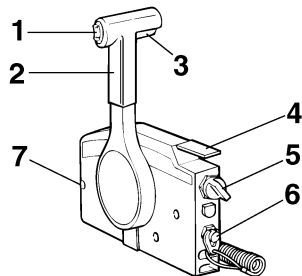

ZMU01723

1. Power trim and tilt switch
2. Remote control lever
3. Neutral interlock trigger
4. Neutral throttle lever
5. Main switch / choke switch
6. Engine shut-off switch
7. Throttle friction adjuster

Basic components

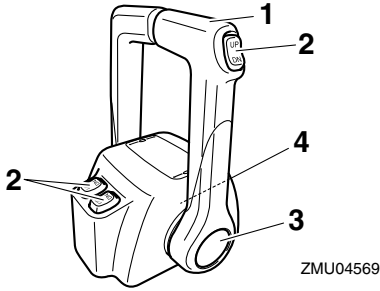

1. Remote control lever
2. Power trim and tilt switch
3. Free accelerator
4. Throttle friction adjuster

EMU26190

Remote control lever

Moving the lever forward from the neutral position engages forward gear. Pulling the lever back from neutral engages reverse. The engine will continue to run at idle until the lever is moved about 35° (a detent can be felt). Moving the lever farther opens the throttle, and the engine will begin to accelerate.

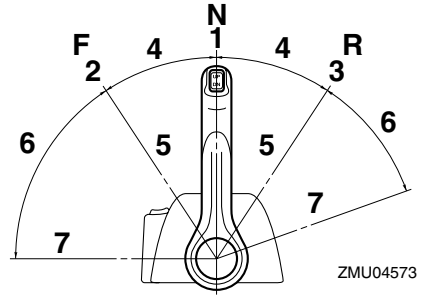

1. Neutral "N"
2. Forward "F"
3. Reverse "R"
4. Shift
5. Fully closed
6. Throttle
7. Fully open

EMU26201

Neutral interlock trigger

To shift out of neutral, first pull the neutral interlock trigger up.

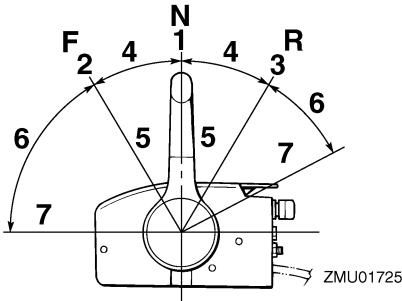

1. Neutral "N"
2. Forward "F"
3. Reverse "R"
4. Shift
5. Fully closed
6. Throttle
7. Fully open

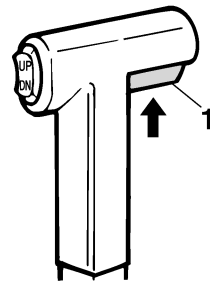

1. Neutral interlock trigger

EMU26211

Neutral throttle lever

To open the throttle without shifting into either forward or reverse, put the remote control lever in the neutral position and lift the neutral throttle lever.

Basic components

NOTE: _____

The neutral throttle lever will operate only when the remote control lever is in neutral. The remote control lever will operate only when the neutral throttle lever is in the closed position.

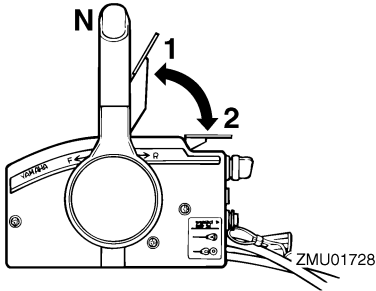

1. Fully open
2. Fully closed

EMU26232

Free accelerator

To open the throttle without shifting into either forward or reverse, push the free accelerator button and move the remote control lever.

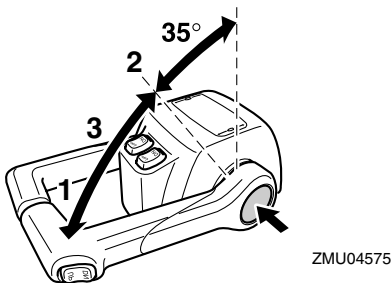

1. Fully open
2. Fully closed
3. Free accelerator

NOTE: _____

- The free accelerator button can only be

used when the remote control lever is in the neutral position.

- After the button is pushed, the throttle begins to open after the remote control lever is moved at least 35°.
- After using the free accelerator, return the remote control lever to the neutral position. The free accelerator button will return automatically to its set position. The remote control will then engage forward and reverse normally.

EMU25911

Tiller handle

To change direction, move the tiller handle to the left or right as necessary.

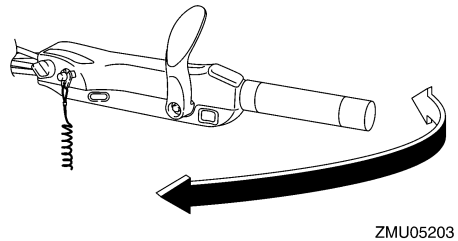

EMU25922

Gear shift lever

Pulling the gear shift lever towards you puts the engine in forward gear so that the boat moves ahead. Pushing the lever away from you puts the engine in reverse gear so that the boat moves astern.

Basic components

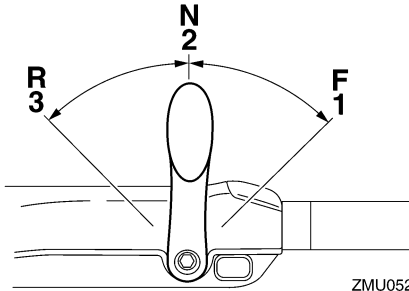

ZMU05204

1. Forward "F"
2. Neutral "N"
3. Reverse "R"

EMU25941

Throttle grip

The throttle grip is on the tiller handle. Turn the grip counterclockwise to increase speed and clockwise to decrease speed.

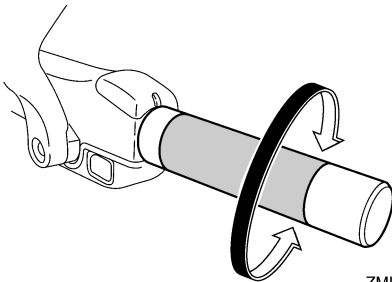

ZMU05205

EMU25961

Throttle indicator

The fuel consumption curve on the throttle indicator shows the relative amount of fuel consumed for each throttle position. Choose the setting that offers the best performance and fuel economy for the desired operation.

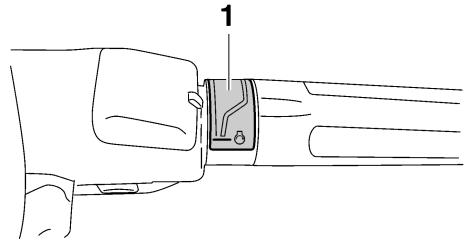

ZMU05206

1. Throttle indicator

EMU25971

Throttle friction adjuster

A friction device provides adjustable resistance to movement of the throttle grip or the remote control lever, and can be set according to operator preference.

To increase resistance, turn the adjuster clockwise. To decrease resistance, turn the adjuster counterclockwise.

EWM00031



WARNING

Do not overtighten the friction adjuster. If there is too much resistance, it could be difficult to move the remote control lever or throttle grip, which could result in an accident.

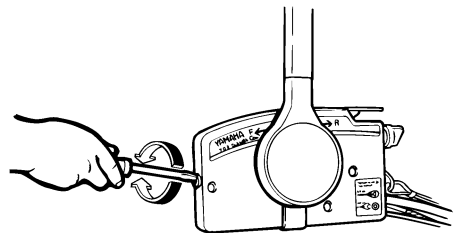

ZMU01714

Basic components

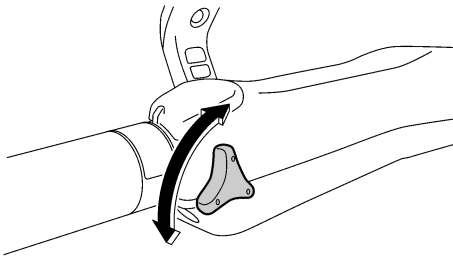
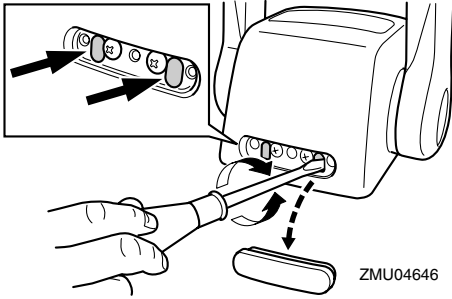

When constant speed is desired, tighten the adjuster to maintain the desired throttle setting.

EMU25991

Engine shut-off switch

The clip must be attached to the engine shut-off switch for the engine to run. The cord should be attached to a secure place on the operator's clothing, or arm or leg. Should the operator fall overboard or leave the helm, the cord will pull out the clip, stopping ignition to the engine. This will prevent the boat from running away under power.

EWM00121

WARNING

- **Attach the engine shut-off cord to a secure place on your clothing, or your arm or leg while operating.**
- **Do not attach the cord to clothing that could tear loose. Do not route the cord where it could become entangled, pre-**

venting it from functioning.

- **Avoid accidentally pulling the cord during normal operation. Loss of engine power means the loss of most steering control. Also, without engine power, the boat could slow rapidly. This could cause people and objects in the boat to be thrown forward.**

NOTE:

The engine cannot be started with the clip removed.

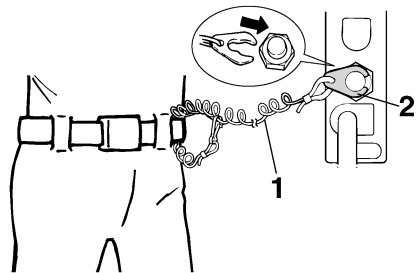

ZMU01716

1. Cord
2. Clip

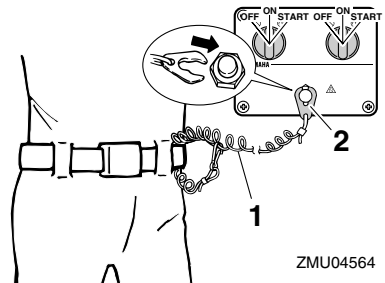

ZMU04564

1. Cord
2. Clip

Basic components

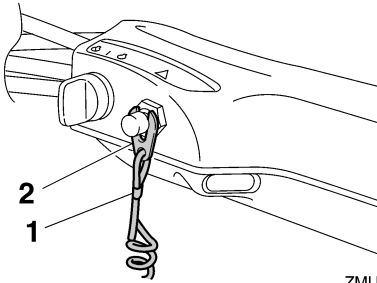

ZMU05208

1. Cord
2. Clip

EMU26001

Engine stop button

To open the ignition circuit and stop the engine, push this button.

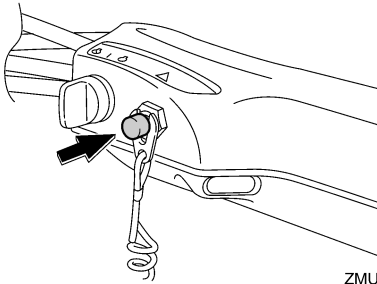

ZMU05209

EMU26090

Main switch

The main switch controls the ignition system; its operation is described below.

● “OFF” (off)

With the main switch in the “OFF” (off) position, the electrical circuits are off, and the key can be removed.

● “ON” (on)

With the main switch in the “ON” (on) position, the electrical circuits are on, and the key cannot be removed.

● “START” (start)

With the main switch in the “START” (start) position, the starter motor turns to start the en-

gine. When the key is released, it returns automatically to the “ON” (on) position.

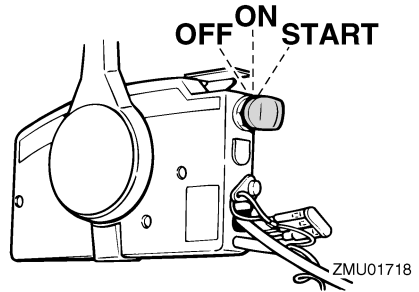

ZMU01718

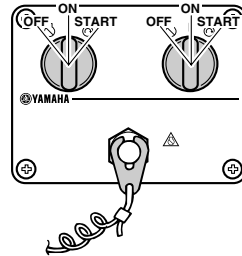

ZMU04566

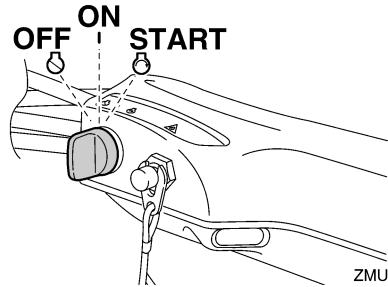

ZMU05210

EMU26111

Steering friction adjuster

A friction device provides adjustable resistance to the steering mechanism, and can be set according to operator preference. An adjuster lever is located on the bottom of the tiller handle bracket.

To increase resistance, turn the lever to the port side “A”.

Basic components

To decrease resistance, turn the lever to the starboard side “B”.

EWM00040



Do not overtighten the friction adjuster. If there is too much resistance, it could be difficult to steer, which could result in an accident.

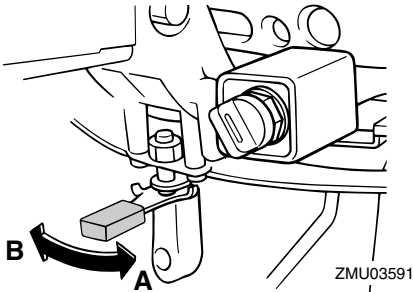

NOTE:

- Check the tiller handle for smooth movement when the lever is turned to the starboard side “B”.
- Do not apply lubricants such as grease to the friction areas of the steering friction adjuster.

EMU26142

Power trim and tilt switch on remote control or tiller handle

The power trim and tilt system adjusts the outboard motor angle in relation to the transom. Pressing the switch “UP” (up) trims the outboard motor up, and then tilts it up. Pressing the switch “DN” (down) tilts the outboard motor down and trims it down. When the switch is released, the outboard motor will stop in its current position.

NOTE:

For instructions on using the power trim and tilt switch, see pages 48 and 50.

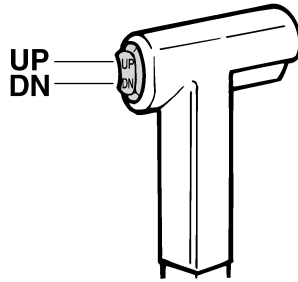

ZMU01720

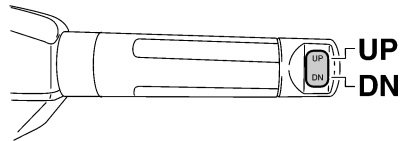

ZMU05211

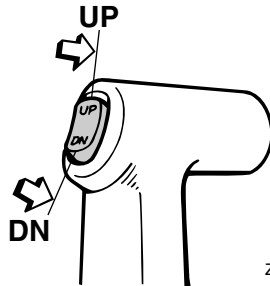

ZMU03938

EMU26152

Power trim and tilt switch on bottom engine cowling

The power trim and tilt switch is located on the side of the bottom engine cowling. Pressing the switch “UP” (up) trims the outboard motor up, and then tilts it up. Pressing the switch “DN” (down) tilts the outboard motor down and trims it down. When the switch is released, the outboard motor will stop in its

Basic components

current position.

EWM01030

WARNING

Use the power trim and tilt switch located on the bottom engine cowling only when the boat is at a complete stop with the engine off. Attempting to use this switch while the boat is moving could increase the risk of falling overboard and could distract the operator, increasing the risk of collision with another boat or an obstacle.

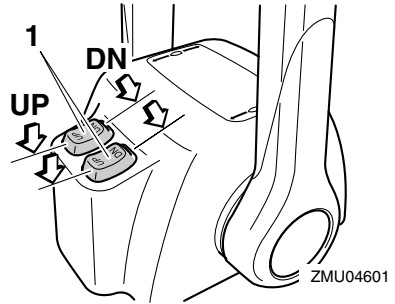

1. Power trim and tilt switch

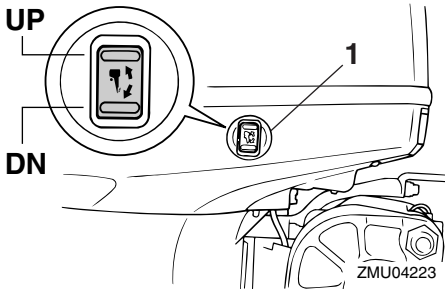

1. Power trim and tilt switch

NOTE:

For instructions on using the power trim and tilt switch, see page 50.

EMU26162

Power trim and tilt switches (twin binnacle type)

The power trim and tilt system adjusts the outboard motor angle in relation to the transom. Pushing the switch “UP” (up) trims the outboard motor up, and then tilts it up. Pressing the switch “DN” (down) tilts the outboard motor down and trims it down. When the switch is released, the outboard motor will stop in its current position.

NOTE:

- On the dual engine control, the switch on the remote control grip controls both outboard motors at the same time.
- For instructions on using the power trim and tilt switches, see pages 48 and 50.

EMU26243

Trim tab with anode

The trim tab should be adjusted so that the steering control can be turned to either the right or left by applying the same amount of force.

EWM00840

WARNING

An improperly adjusted trim tab could cause difficult steering. Always test run after the trim tab has been installed or replaced to be sure steering is correct. Be sure you have tightened the bolt after adjusting the trim tab.

If the boat tends to veer to the left (port side), turn the trim tab rear end to the port side “A” in the figure. If the boat tends to veer to the right (starboard side), turn the trim tab end to the starboard side “B” in the figure.

ECM00840

CAUTION:

The trim tab also serves as an anode to

Basic components

protect the engine from electrochemical corrosion. Never paint the trim tab as it will become ineffective as an anode.

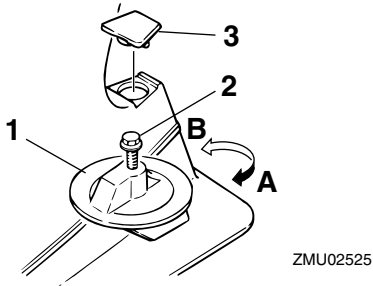

1. Trim tab
2. Bolt
3. Cap

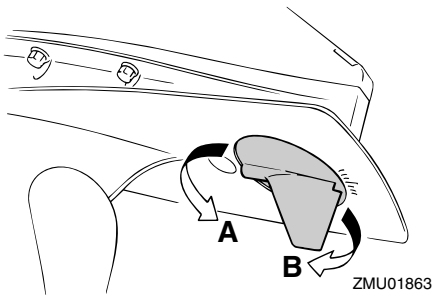

Bolt tightening torque:
42.0 Nm (31 ft-lb) (4.2 kgf-m)

EMU26341

Tilt support lever for power trim and tilt model

To keep the outboard motor in the tilted up position, lock the tilt support lever to the clamp bracket.

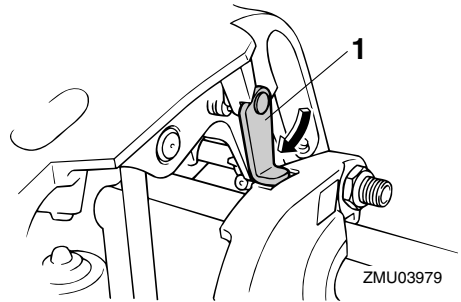

1. Tilt support lever

ECM00660

CAUTION:

Do not use the tilt support lever or knob when trailering the boat. The outboard motor could shake loose from the tilt support and fall. If the motor cannot be trailered in the normal running position, use an additional support device to secure it in the tilt position.

EMU26382

Top cowling lock lever (pull up type)

To remove the engine top cowling, pull up the lock lever(s) and lift off the cowling. When installing the cowling, check to be sure it fits properly in the rubber seal. Then lock the cowling by moving the lever(s) downward.

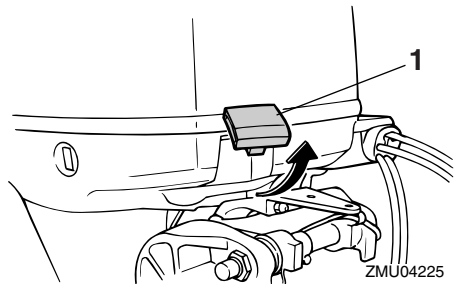

1. Top cowling lock lever(s)

Basic components

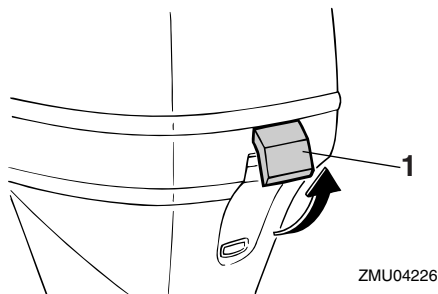

1. Top cowling lock lever(s)

EMU26460

Flushing device

This device is used to clean the cooling water passages of the motor using a garden hose and tap water.

NOTE:

For details on usage, see page 60.

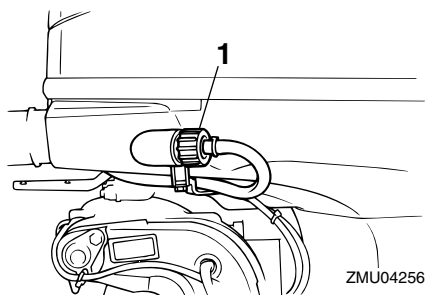

1. Flushing device

EMU31703

Fuel filter/Water separator

This engine has a combination fuel filter/water separator and associated warning system. If water separated from the fuel exceeds a specific volume, the warning device of Command Link Tachometer will activate.

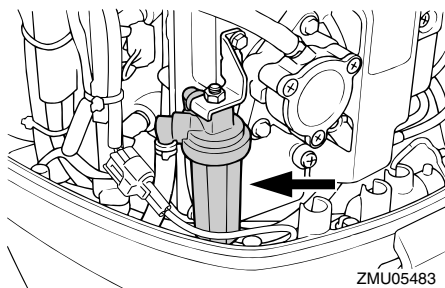

Activation of warning device

- The water separator-warning indicator of Command Link Tachometer will blink.
- The buzzer will sound intermittently only when the gear shift is in neutral.
- If the warning system has activated, stop the engine and consult a Yamaha dealer immediately.

EMU26302

Warning indicator

If the engine develops a condition which is cause for warning, the indicator lights up. For details on how to read the warning indicator, see page 35.

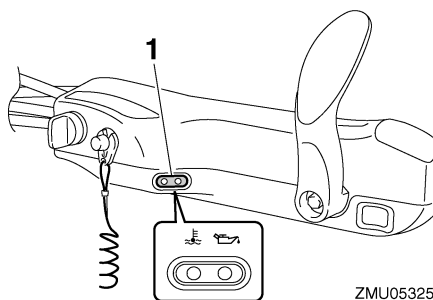

1. Warning indicator

EMU26491

Digital tachometer

The tachometer shows the engine speed and has the following functions.

Basic components

NOTE:

All segments of the display will light momentarily after the main switch is turned on and will return to normal thereafter.

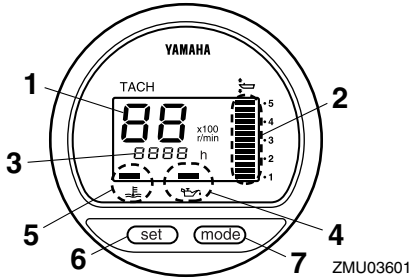

1. Tachometer
2. Trim meter
3. Hour meter
4. Low oil pressure-warning indicator
5. Overheat-warning indicator
6. Set button
7. Mode button

NOTE:

The water separator and engine trouble warning indicators only operate when the engine is equipped with the appropriate functions.

EMU26523

Low oil pressure-warning indicator

If oil pressure drops too low, the warning indicator will start to blink. For further information, see page 35.

ECM00021

CAUTION:

- Do not continue to run the engine if the low oil pressure-warning indicator is on and the engine oil level is lower. Serious engine damage will occur.
- The low oil pressure-warning indicator does not indicate the engine oil level.

Use the oil dipstick to check the remaining oil quantity. For further information, see page 40.

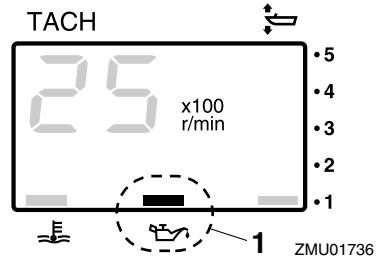

1. Low oil pressure-warning indicator

EMU26582

Overheat-warning indicator (digital type)

If the engine temperature rises too high, the warning indicator will start to blink. For further information on reading the indicator, see page 35.

ECM00051

CAUTION:

Do not continue to run the engine if the overheat-warning indicator is on. Serious engine damage will occur.

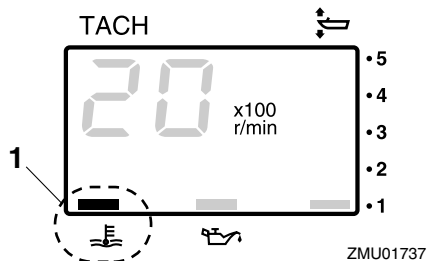

1. Overheat-warning indicator

Basic components

EMU26601

Speedometer (digital type)

This gauge shows the boat speed.

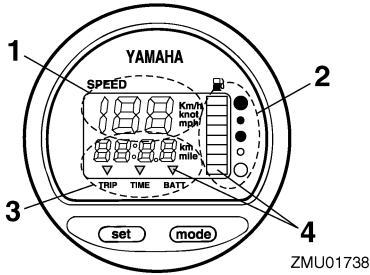

ZMU01738

1. Speedometer
2. Fuel gauge
3. Trip meter/clock/voltmeter
4. Warning indicator(s)

NOTE:

After the main switch is first turned on, all segments of the display come on as a test. After a few seconds, the gauge will change to normal operation. Watch the gauge when turning on the main switch to make sure all segments come on.

NOTE:

The speedometer displays km/h, mph, or knots, according to operator preference. Select the desired units of measurement by setting the selector switch on the back of the gauge. See the illustration for settings.

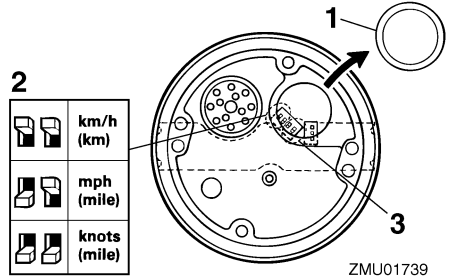

ZMU01739

1. Cap
2. Selector switch (for speed unit)
3. Selector switch (for fuel sensor)

EMU26620

Trim meter (digital type)

This meter shows the trim angle of your out-board motor.

NOTE:

- Memorize the trim angles that work best for your boat under different conditions. Adjust the trim angle to the desired using the power trim and tilt switch.
- If the trim angle of your motor exceeds the trim operating range, the top segment of the trim meter display will blink.

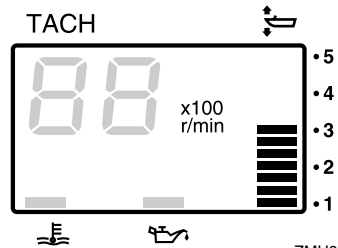

ZMU01740

EMU26650

Hour meter (digital type)

This meter shows the number of hours the engine has been run. It can be set to show the total number of hours or the number of

Basic components

hours for the current trip. The display can also be turned on and off.

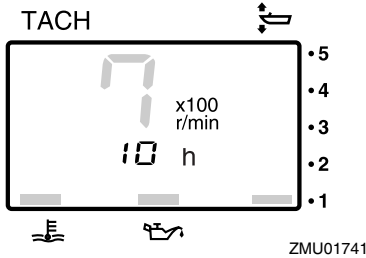

- Changing the display format
- Pressing the “mode” (mode) button changes the display format in the following pattern:
 - Total hours→Trip hours→Display off
 - Resetting the trip hours
 - Simultaneously pressing the “set” (set) and “mode” (mode) buttons for more than 1 second while the trip hours are displayed resets the trip counter to 0 (zero).

NOTE: _____
The total number of hours the engine has been run cannot be reset.

EMU26690

Trip meter

This gauge displays the distance the boat has traveled since the gauge was last reset. Press the “mode” (mode) button repeatedly until the indicator on the face of the gauge points to “TRIP” (trip). To reset the trip meter to zero, press the “set” (set) and “mode” (mode) buttons at the same time.

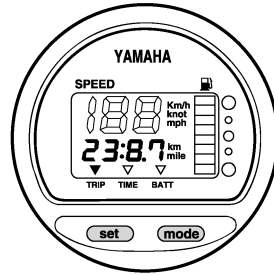

- NOTE:** _____
- The trip distance is shown in kilometers or miles depending upon the unit of measurement selected for the speedometer.
 - The trip distance is kept in memory by battery power. The stored data will be lost if the battery is disconnected.

EMU26700

Clock

Press the “mode” (mode) button repeatedly until the indicator on the face of the gauge points to “TIME” (time). To set the clock, be sure the gauge is in the “TIME” (time) mode. Press the “set” (set) button; the hour display will begin blinking. Press the “mode” (mode) button until the desired hour is displayed. Press the “set” (set) button again, the minute display will begin blinking. Press the “mode” (mode) button until the desired minute is displayed. Press the “set” (set) button again to start the clock.

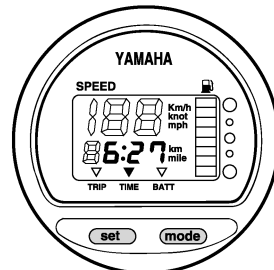

Basic components

NOTE:

The clock operates on battery power. Disconnecting the battery will stop the clock. Reset the clock after connecting the battery.

EMU26711

Fuel gauge

Eight segments indicate the fuel level. When all segments are showing, the fuel tank is full.

ECM00860

CAUTION:

The Yamaha fuel tank sensor differs from conventional sensors. Incorrectly setting the selector switch on the gauge will give false readings. Consult your Yamaha dealer on how to correctly set the selector switch.

NOTE:

The fuel level reading can be affected by the position of the sensor in the fuel tank and the attitude of the boat in the water. Operation with bow-up trim or continuous turning can give false readings.

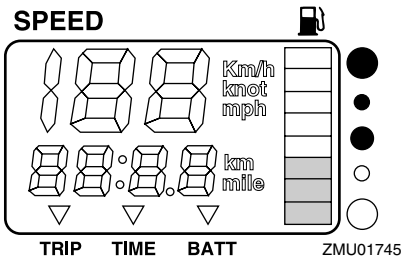

EMU26720

Fuel warning indicator

If the fuel level decreases to one segment, the fuel level warning segment will begin to blink.

blink.

ECM00880

CAUTION:

Do not continue to operate the engine with full throttle if a warning device has activated. Get back to the port within trolling engine speed.

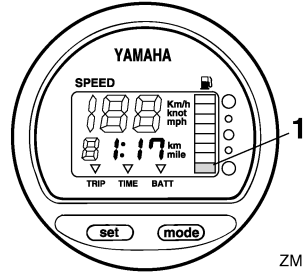

1. Fuel level warning segment

EMU26731

Low battery voltage-warning indicator

If battery voltage drops, the display will automatically turn on and begin to blink.

ECM00870

CAUTION:

Get back to the port soon if a warning device has activated. For charging the battery, consult your Yamaha dealer.

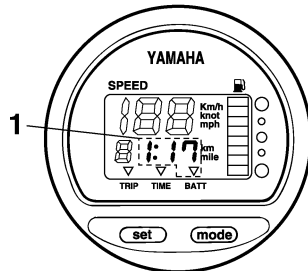

1. Low battery indicator

Basic components

EMU26740

Fuel management meter

The fuel management meter shows the state of the fuel consumption while the engine is running.

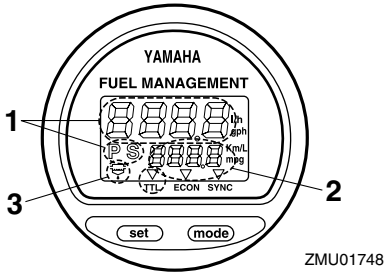

ZMU01748

1. Fuel flow meter
2. Fuel consumption meter / Fuel economy meter / Twin engine speed synchronizer
3. Water separator-warning indicator (operates only if the sensor has been installed)

NOTE:

After the main switch is first turned on, all segments of the display come on as a test. After a few seconds, the gauge will change to normal operation. Watch the gauge when turning on the main switch to make sure all segments come on.

EMU26751

Fuel flow meter

The fuel flow meter displays the amount of fuel flow over a one-hour period, at the current rate of engine operation.

Fuel flow readings are not accurate when the engine is operating under about 1300 r/min. As the fuel pump cycles on and off, the display indicates either no fuel flow or higher flow than the actual average use.

If twin engines are installed on your boat, the fuel flow meter displays the total fuel flow of both the port and starboard engines. It also

displays "P S" (for port and starboard).

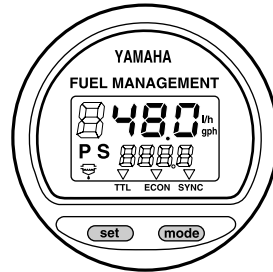

ZMU01749

Use the "set" (set) button to rotate the fuel flow display in the following order:

- Press the "set" (set) button once to display the fuel flow of the starboard engine. An "S" (for starboard) will also be displayed.
- Press the "set" (set) button a second time to display the fuel flow of the port engine. A "P" (for port) will also be displayed.
- Press the "set" (set) button a third time to return the display to the total fuel flow of both engines. "P S" (for port and starboard) will also be displayed to indicate both the port and starboard engines.

NOTE:

- The fuel flow meter displays gallons/hour or liters/hour according to operator preference. Select the desired units of measurement by setting the selector switch on the back of the gauge during installation.

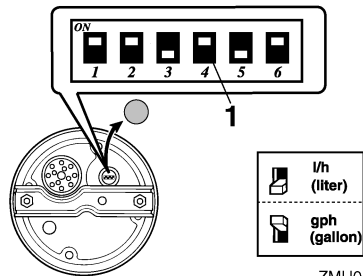

ZMU01750

1. Selector switch

Basic components

- The fuel consumption meter and fuel economy meter will indicate the same unit of measurement.

EMU26760

Fuel consumption meter

This gauge displays the total amount of fuel consumed since the gauge was last reset. Press the “mode” (mode) button repeatedly until the indicator on the face of the gauge points to total “TTL” (total). To reset the total fuel consumption to zero, press the “set” (set) and “mode” (mode) buttons at the same time.

FUEL MANAGEMENT

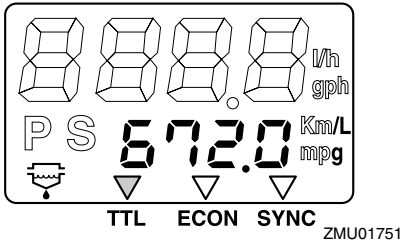

EMU26770

Fuel economy

This gauge displays the distance per liter or gallon when cruising, and is only for reference use by the operator. Press the “mode” (mode) button repeatedly until the indicator on the face of the gauge points to “ECON” (economy).

FUEL MANAGEMENT

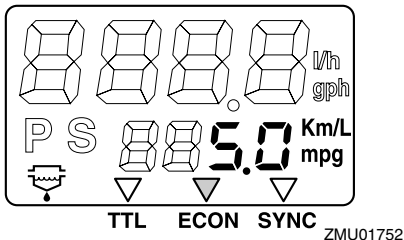

NOTE:

If twin engines are installed on your boat, the gauge will only display the total fuel economy of both engines.

NOTE:

- Fuel consumption varies greatly with boat design, weight, propeller used, engine trim angle, sea conditions (including wind), and throttle position. Fuel consumption also varies slightly with the type of water (salt, fresh, and contaminate levels), air temperature and humidity, cleanliness of the boat bottom, engine mounting height, skill of the operator, and individual gasoline formulation (winter or summer fuel and amount of additives).
- The Yamaha digital speedometer and fuel management meter calculates speed, miles traveled, and fuel economy by water movement at the stern of the boat. This distance can vary greatly from the actual distance traveled because of water currents, sea swells, and the condition of the water speed sensor (partially plugged or damaged).
- Individual engines may slightly vary in their fuel consumption due to manufacturing variations. These variations can be even greater if the engines are of different year models. In addition, variations in propellers, even of the same basic dimensions of the same design, can also cause a slight variation in fuel consumption.

EMU26781

Twin-engine speed synchronizer

This gauge displays the difference in engine speed (r/min) between the port and starboard engines for reference purposes when synchronizing the two engines' speeds.

Press the “mode” (mode) button repeatedly

Basic components

until the indicator on the face of the gauge points to "SYNC" (synchronizer).

FUEL MANAGEMENT

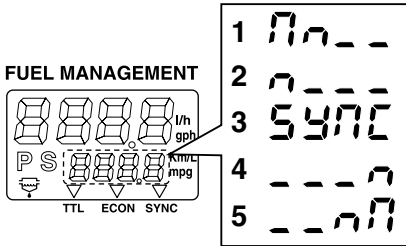
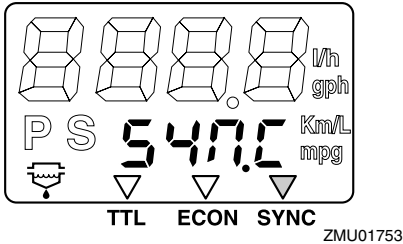

1. Port engine speed is higher
2. Port engine speed is slightly higher
3. Engine speed is synchronized evenly between port and starboard engines
4. Starboard engine speed is slightly higher
5. Starboard engine speed is higher

NOTE:

If the two engines' speeds are not synchronized while cruising, adjusting trim angle or throttle can synchronize them.

EMU31651

6Y8 Multifunction meters

Multifunction meters have 6 kinds of meter units; tachometer unit (square or round types), speedometer unit (square type), speed & fuel meter unit (square or round types), and fuel management meter (square type). The indicator system is slightly differ-

ent between the round and square types. Check the model and type of your unit carefully. This manual describes mainly the warning indicators. For more details on setting meters or changing indicator systems, see the attached operation manual.

EMU31681

Tachometer unit

The tachometer shows the engine revolutions per minute. It has functions of trim meter, adjusting trolling speed, cooling water/engine temperature display, battery voltage display, total hour/trip hour display, oil pressure display, water detection warning, engine trouble warning, and periodic maintenance notification. If optional sensors are connected to the unit, cooling water pressure display will be available. For the optional sensor, consult your Yamaha dealer. The tachometer unit is available in round or square types. Check your tachometer unit type.

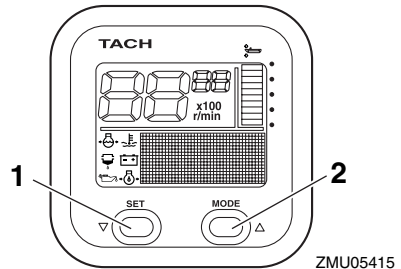

1. Set button
2. Mode button

Basic components

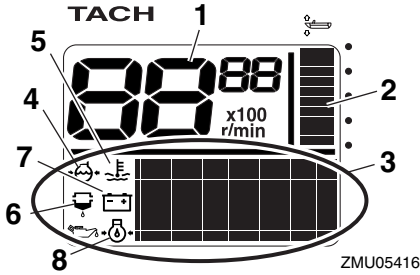

1. Tachometer
2. Trim meter
3. Multifunction display
4. Cooling water pressure
5. Cooling water/engine temperature
6. Water detection warning indicator
7. Battery voltage
8. Oil pressure (4-stroke models)

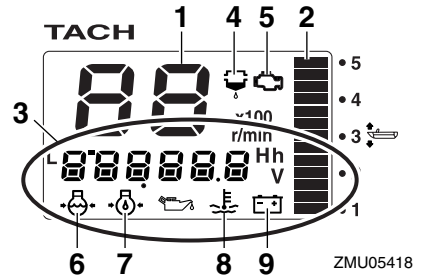

1. Tachometer
2. Trim meter
3. Multifunction display
4. Water detection warning indicator
5. Engine trouble warning/maintenance indicator
6. Cooling water pressure
7. Oil pressure (4-stroke models)
8. Cooling water/engine temperature
9. Battery voltage

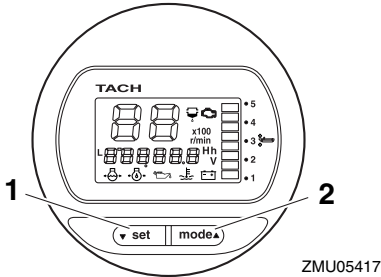

1. Set button
2. Mode button

NOTE:

The tachometer unit shows various kinds of information according to the setting made using the “set” (set) and “mode” (mode) buttons. For details, see the attached operation manual.

Pre-operation checks

Place the remote control lever / gear shift lever in neutral and turn the main switch to “ON” (on). After all the displays come on and the total hour display comes on, the gauge will change to normal operation. If the buzzer sounds and the water separator-warning indicator blinks, consult your Yamaha dealer immediately.

NOTE:

To stop the buzzer, press the “set” (set) or “mode” (mode) button.

Low oil pressure warning

When the engine oil pressure drops too low,

Basic components

the low oil pressure-warning indicator will start to blink, and the engine speed will automatically decrease to about 2000 r/min.

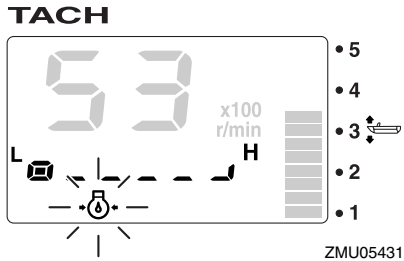
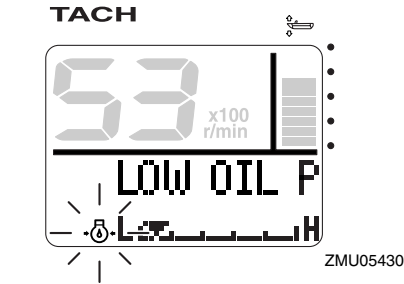

Stop the engine immediately if the buzzer sounds and the low oil pressure-warning indicator blinks. Check the engine oil quantity and replenish oil if necessary. If the warning device has activated while the appropriate engine oil quantity is maintained, consult your Yamaha dealer.

ECM01600

CAUTION: _____
Do not continue to run the engine if the low oil pressure warning device has activated. Serious engine damage will occur.

Overheat warning

If the engine temperature rises too high while cruising, the overheat-warning indicator will start to blink. The engine speed will automatically decrease to about 2000 r/min.

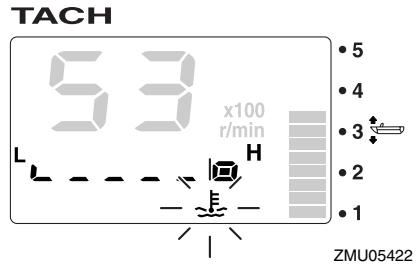
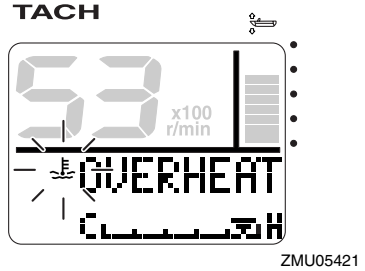

Stop the engine immediately if the buzzer sounds and the overheat warning device has activated. Check the cooling water inlet for clogging.

ECM01591

CAUTION: _____
● **Do not continue to run the engine if the overheat-warning indicator blinks. Serious engine damage will occur.**
● **Do not continue to operate the engine if a warning device has activated. Consult your Yamaha dealer if the problem cannot be located and corrected.**

Water separator warning

This indicator will blink when water has accumulated in the water separator (fuel filter) while cruising. In such an event, stop the engine immediately and see page 81 of this manual to drain the water from the fuel filter. Get back to the port soon and consult a

Basic components

Yamaha dealer immediately.

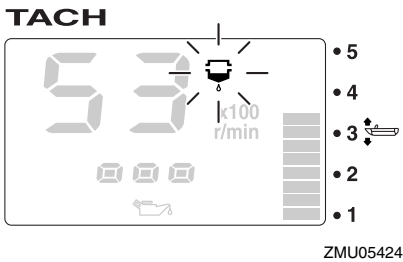
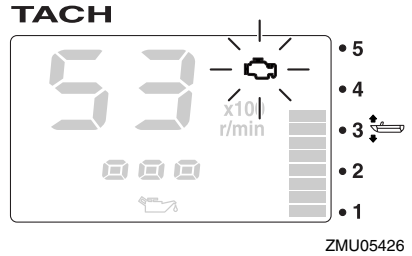
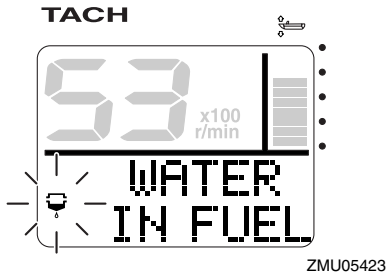

ECM00910

CAUTION:

Gasoline mixed with water could cause damage to the engine.

Engine trouble warning

This indicator will blink when the engine malfunctions while cruising. Get back to the port soon and consult a Yamaha dealer immediately.

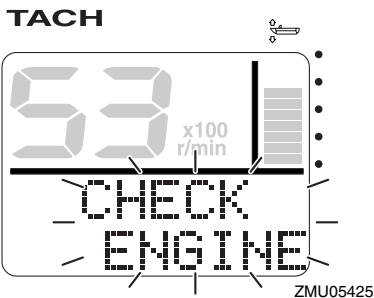

ECM00920

CAUTION:

In such an event, the engine will not operate properly. Consult a Yamaha dealer immediately.

Low battery voltage warning

When the battery voltage drops, the low battery voltage-warning indicator and the battery voltage value will start to blink. Get back to the port soon if the low battery voltage-warning device has activated. For charging the battery, consult your Yamaha dealer.

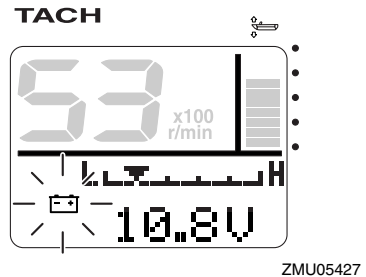

Basic components

TACH

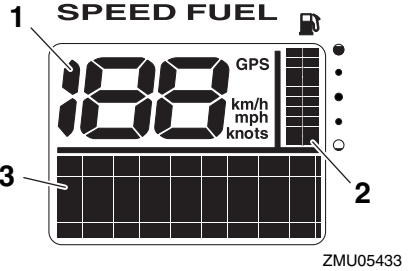
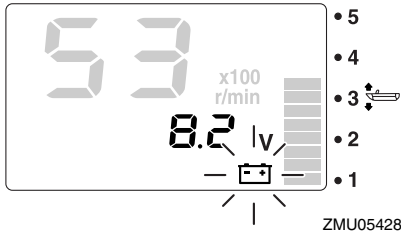

EMU31610

Speed & fuel meter unit

This unit shows the boat speed and has the functions of fuel meter, total fuel consumption display, fuel economy display, fuel flow display, and system voltage display. If optional sensors are connected to the unit, trip display, water surface temperature display, depth display, and clock will be available. For the optional sensor, consult your Yamaha dealer. The speed & fuel meter unit is available in round or square types. Check your speed & fuel meter unit type.

1. Speedometer
2. Fuel meter
3. Multifunction display

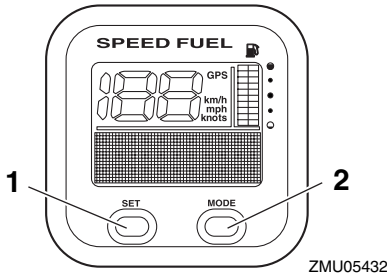
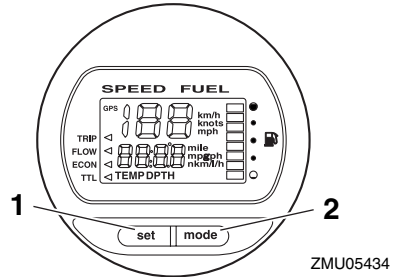

1. Set button
2. Mode button

1. Set button
2. Mode button

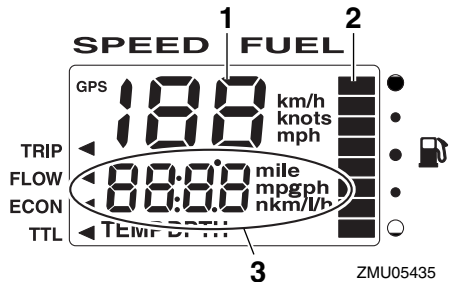

1. Speedometer
2. Fuel meter
3. Multifunction display

Basic components

NOTE: _____

After the main switch is first turned on, all the displays come on as a test. After a few seconds, the gauge will change to normal operation.

NOTE: _____

The speed & fuel meter unit shows various kinds of information according to the setting made with the “set” (set) and “mode” (mode) buttons. For details, see the attached operation manual.

EMU31620

Speedometer unit

This unit shows the boat speed and has functions of fuel meter and system voltage display. If optional sensors are connected to the unit, trip display, water surface temperature display, depth display, and clock will be available. For the optional sensor, consult your Yamaha dealer.

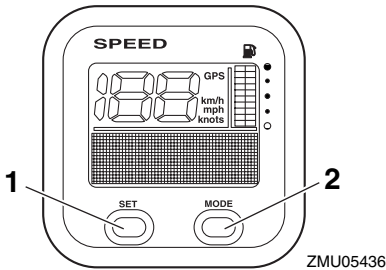

- 1. Set button
- 2. Mode button

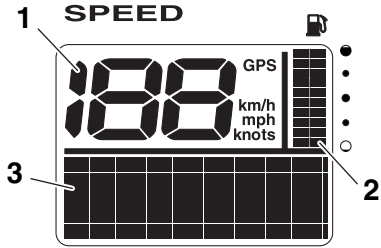

- 1. Speedometer
- 2. Fuel meter
- 3. Multifunction display

NOTE: _____

After the main switch is first turned on, all the displays come on as a test. After a few seconds, the gauge will change to normal operation.

NOTE: _____

The speedometer unit shows various kinds of information according to the setting made using the “set” (set) and “mode” (mode) buttons. In addition, the speedometer can show the desired unit of measurement such as km/h, mph, or knots. For details, see the attached operation manual.

EMU31630

Fuel management meter

This meter has functions of fuel flow meter, total consumption display, fuel economy display, and remaining fuel display.

Basic components

EMU26801

Warning system

ECM00090

CAUTION:

Do not continue to operate the engine if a warning device has activated. Consult your Yamaha dealer if the problem cannot be located and corrected.

EMU30342

Overheat warning (twin engines)

This engine has an overheat-warning device. If the engine temperature rises too high, the warning device will activate.

Activation of warning device

- Engine speed will automatically decrease to 2000–3500 r/min.
- If equipped with an overheat-warning indicator, it will light or blink.

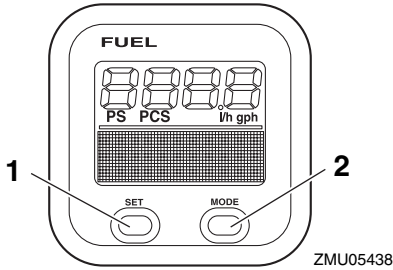

1. Set button
2. Mode button

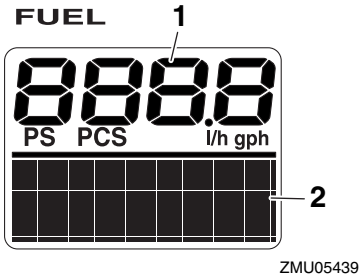

1. Fuel flow meter
2. Multifunction display

NOTE:

After the main switch is first turned on, all the displays come on as a test. After a few seconds, the gauge will change to normal operation.

NOTE:

The fuel management meter shows various kinds of information when the operator uses the “set” (set) and “mode” (mode) buttons. For details, see the attached operation manual.

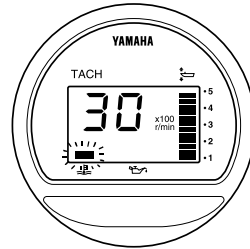

ZMU04227

- The buzzer will sound.

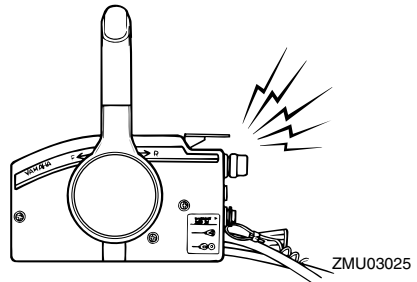

ZMU03025

Basic components

- The low oil pressure-warning indicator will light or blink.

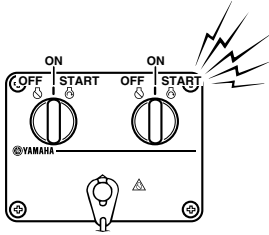

ZMU04584

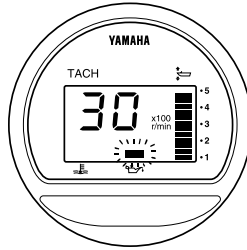

ZMU04254

If the warning system has activated, stop the engine and check the cooling water inlet for clogging.

- The buzzer will sound.

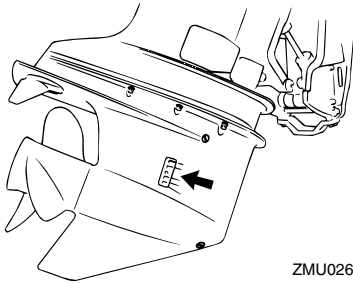

ZMU02630

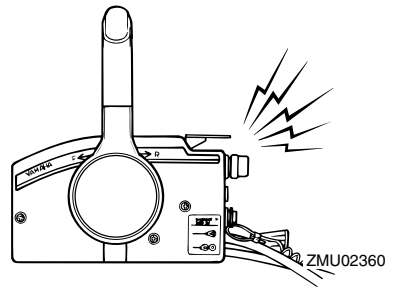

ZMU02360

NOTE:

Dual engine drive users:

Should the overheat warning system of one engine activate, the engine will slow down and the buzzer will sound. This will cause the other engine to slow down and the buzzer to sound. To switch off the warning activation on the engine not affected by overheating, turn off the main switch of the engine over-heating.

EMU30353

Low oil pressure warning

If the oil pressure drops too low, the warning device will activate.

Activation of warning device

- Engine speed will automatically decrease to 2000–3500 r/min.

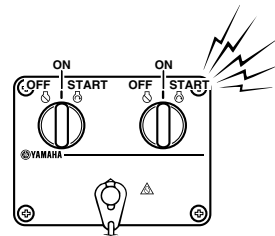

ZMU04584

If the warning system has activated, stop the engine as soon as it is safe to do so. Check the oil level and add oil as needed. If the oil level is correct, consult your Yamaha dealer.

ECM00101

CAUTION:

Do not continue to run the engine if the low oil pressure-warning indicator is on.

Basic components

Serious engine damage could occur.

Operation

EMU26902

Installation

The information presented in this section is intended as reference only. It is not possible to provide complete instructions for every possible boat and motor combination. Proper mounting depends in part on experience and the specific boat and motor combination.

EWMO1590

WARNING

- **Overpowering a boat could cause severe instability. Do not install an outboard motor with more horsepower than the maximum rating on the capacity plate of the boat. If the boat does not have a capacity plate, consult the boat manufacturer.**
- **Improper mounting of the outboard motor could result in hazardous conditions such as poor handling, loss of control, or fire hazards. For permanently mounted models, your dealer or other person experienced in proper rigging should mount the motor.**

EMU33480

Mounting the outboard motor

The outboard motor should be mounted so that the boat is well balanced. Otherwise, the boat could be hard to steer. For single-engine boats, mount the outboard motor on the centerline (keel line) of the boat. For dual engine boats, mount the outboard motors equidistant from the centerline. Consult your Yamaha dealer or boat manufacturer for further information on determining the proper mounting location.

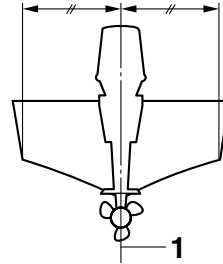

ZMU01760

1. Center line (keel line)

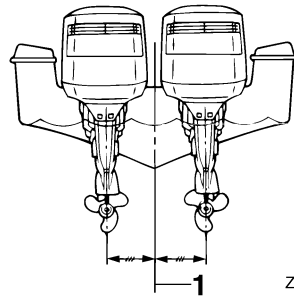

ZMU01761

1. Center line (keel line)

EMU26931

Mounting height (boat bottom)

The mounting height of your outboard motor affects its efficiency and reliability. If it is mounted too high, propeller ventilation may occur, which will reduce propulsion due to excessive propeller slip, and the water intakes for the cooling system may not get adequate water supply, which can cause engine overheating. If the engine is mounted too low, water resistance (drag) will increase, thereby reducing engine efficiency and performance.

Most commonly, outboard motor should be mounted so that the anti-cavitation plate is in alignment with the bottom of the boat. The optimum mounting height of the outboard

motor is affected by the boat/motor combination and the desired use. Test runs at different heights can help determine the optimum mounting height. Consult your Yamaha dealer or boat manufacturer for further information on determining the proper mounting height.

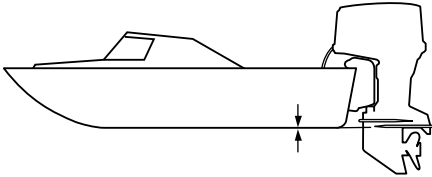

ZMU01874

ECM01630

CAUTION:

- During water testing, check the buoyancy of the boat, at rest, with its maximum load. Check that the static water level on the exhaust housing is low enough to prevent water entry into the power head when water rises due to waves when the outboard is not running.
- Incorrect engine height or obstructions to the smooth flow of water (such as the design or condition of the boat, or accessories such as transom ladders or depth finder transducers) can create airborne water spray while the boat is cruising. If the motor is operated continuously in the presence of airborne water spray, enough water could enter the engine through the intake opening on the cowling to cause severe engine damage. Eliminate the cause of the airborne water spray.

EMU30173

Breaking in engine

Your new engine requires a period of break-in to allow mating surfaces of moving parts to wear in evenly. Correct break-in will help ensure proper performance and longer engine life.

ECM00800

CAUTION:

Failure to follow the break-in procedure could result in reduced engine life or even severe engine damage.

EMU27083

Procedure for 4-stroke models

Your new engine requires a period of ten-hours break-in to allow mating surfaces of moving parts to wear in evenly. Correct break-in will help ensure proper performance and longer engine life.

NOTE:

Failure to follow the break-in procedure could result in reduced engine life or even severe engine damage. Run the engine in the water, under load (in gear with a propeller installed) as follows. For ten hours for breaking in engine avoid extended idling, rough water and crowded areas.

1. For the first hour of operation:
Run the engine at varying speeds up to 2000 r/min or approximately half throttle.
2. For the second hour of operation:
Increase engine speed as much as necessary to put the boat on plane (but avoid full-throttle operation), then back off on the throttle while keeping the boat at a planing speed.
3. Remaining eight hours:
Run the engine at any speed. However, avoid operating at full throttle for more than 5 minutes at a time.

Operation

4. After the first 10 hours:
Operate the engine normally.

EMU27104

Pre-operation checks

EWMO0081



If any item in the pre-operation check is not working properly, have it inspected and repaired before operating the outboard motor. Otherwise an accident could occur.

ECM00120

CAUTION:

Do not start the engine out of water. Overheating and serious engine damage can occur.

EMU31551

Fuel

- Check to be sure you have plenty of fuel for your trip.
- Make sure there are no fuel leaks or gasoline fumes.
- Check fuel line connections to be sure they are tight (if equipped Yamaha fuel tank or boat tank).
- Be sure the fuel tank is positioned on a secure, flat surface, and that the fuel line is not twisted or flattened, or likely to contact sharp objects (if equipped Yamaha fuel tank or boat tank).
- Check the water in the fuel filter with the water separator warning device. Place the remote control lever / gear shift lever in neutral and turn the main switch to "ON"(on). If the buzzer sounds and the water separator-warning indicator blinks, consult your Yamaha dealer immediately.

EMU31710

Controls

- Check throttle, shift, and steering for proper operation before starting the engine.

- The controls should work smoothly, without binding or unusual free play.
- Look for loose or damaged connections.

EMU31721

Stop switches

- Confirm that turning the main switch to the "OFF" (off) position stops the engine.
- Confirm that removing the clip from the engine shut-off switch stops the engine.
- Confirm that the engine cannot be started with the clip removed from the engine shut-off switch.

EMU27150

Engine

- Check the engine and engine mounting.
- Look for loose or damaged fasteners.
- Check the propeller for damage.
- Check that the battery is in good condition and the battery connections are secure.

EMU27163

Checking the engine oil level

1. Put the outboard motor in an upright position (not tilted).
2. Remove oil dipstick and wipe it clean.
3. Completely insert the dipstick and remove it again.
4. Check the oil level using the dipstick to be sure the level falls between the upper and lower marks. Fill with oil if it is below the lower mark, or drain to the specified level if it is above the upper mark.

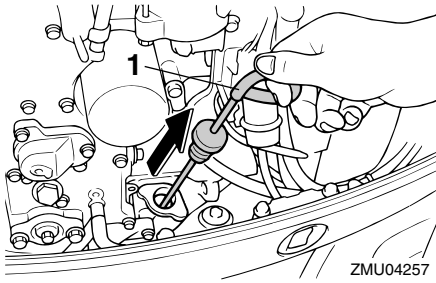

ZMU04257

1. Oil dipstick

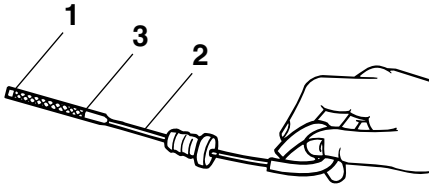

ZMU02082

1. Lower level mark
2. Oil dipstick
3. Upper level mark

NOTE:

Be sure to completely insert the dipstick into the dipstick guide.

EMU30021

Filling fuel

EWM00060



WARNING

Gasoline and its vapors are highly flammable and explosive. Keep away from sparks, cigarettes, flames, or other sources of ignition.

1. Remove the fuel tank cap.
2. Carefully fill the fuel tank.
3. Securely close the cap after filling the

tank. Wipe up any spilled fuel.

EMU27450

Operating engine

EMU27482

Feeding fuel

EWM00420



WARNING

- Before starting the engine, make sure that the boat is tightly moored and that you can steer clear of any obstructions. Be sure there are no swimmers in the water near you.
- When the air vent screw is loosened, gasoline vapor will be released. Gasoline is highly flammable, and its vapors are flammable and explosive. Refrain from smoking, and keep away from open flames and sparks while loosening the air vent screw.
- This product emits exhaust gases which contain carbon monoxide, a colorless, odorless gas which could cause brain damage or death when inhaled. Symptoms include nausea, dizziness, and drowsiness. Keep cockpit and cabin areas well ventilated. Avoid blocking exhaust outlets.

1. If there is an air vent screw on the fuel tank cap, loosen it 2 or 3 turns.
2. If there is a fuel joint or a fuel cock on the boat, firmly connect the fuel line to the joint or open the fuel cock.
3. Squeeze the primer pump, with the arrow pointing up, until you feel it become firm.

Operation

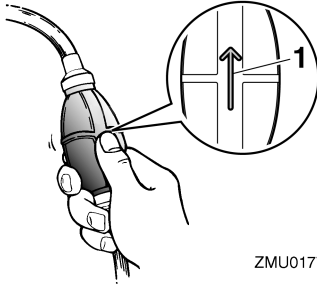

ZMU01770

1. Arrow

EMU27491

Starting engine

EWM01600

WARNING

Before starting the engine, make sure that the boat is tightly moored and that you can steer clear of any obstructions. Be sure there are no swimmers in the water near you.

EMU27593

Electric start / prime start models

1. Place the gear shift lever in neutral.

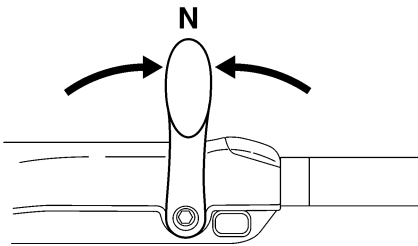

ZMU05215

NOTE:

The start-in-gear protection device prevents the engine from starting except when in neutral.

2. Attach the engine shut-off cord to a secure place on your clothing, or your arm or leg. Then install the clip on the other

end of the cord into the engine shut-off switch.

EWM00121

WARNING

- Attach the engine shut-off cord to a secure place on your clothing, or your arm or leg while operating.
- Do not attach the cord to clothing that could tear loose. Do not route the cord where it could become entangled, preventing it from functioning.
- Avoid accidentally pulling the cord during normal operation. Loss of engine power means the loss of most steering control. Also, without engine power, the boat could slow rapidly. This could cause people and objects in the boat to be thrown forward.

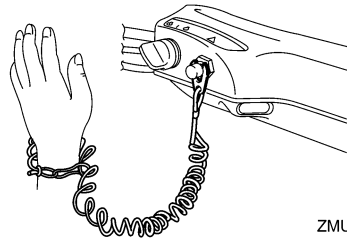

ZMU05216

3. Place the throttle grip in the "START" (start) position. After the engine starts, return the throttle to the fully closed position.

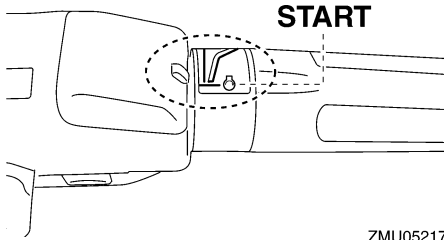

ZMU05217

4. Turn the main switch to "START" (start), and hold it for a maximum of 5 seconds.

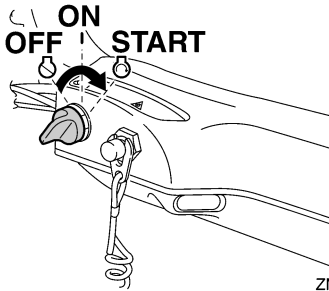

ZMU05218

5. Immediately after the engine starts, release the main switch and allow it to return to "ON" (on).

ECM00191

CAUTION:

- Never turn the main switch to "START" (start) while the engine is running.
- Do not keep the starter motor turning for more than 5 seconds. If the starter motor is turned continuously for more than 5 seconds, the battery will be quickly discharged, thus making it impossible to start the engine. The starter can also be damaged. If the engine will not start after 5 seconds of cranking, return the main switch to "ON" (on), wait 10 seconds, then crank the engine again.

NOTE:

- When the engine is cold, it needs to be warmed up. For further information, see page 45.
- If the engine is warm and fails to start, open the throttle slightly and try to start the engine again. If the engine still fails to start, see page 78.

EMU27625

Electric start and remote control models

1. Place the remote control lever in "N" (neutral).

NOTE:

The start-in-gear protection device prevents the engine from starting except when in neutral.

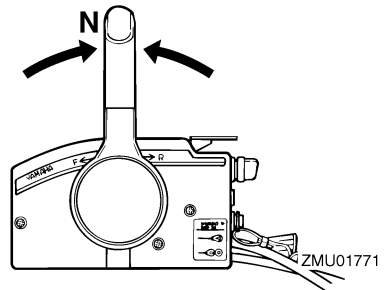

ZMU01771

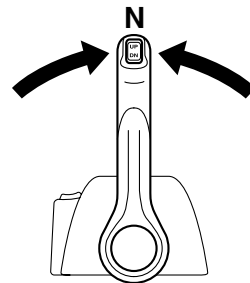

ZMU04588

2. Attach the engine shut-off cord to a secure place on your clothing, or your arm or leg. Then install the clip on the other end of the cord into the engine shut-off

Operation

switch.

EWM00121

WARNING

- Attach the engine shut-off cord to a secure place on your clothing, or your arm or leg while operating.
- Do not attach the cord to clothing that could tear loose. Do not route the cord where it could become entangled, preventing it from functioning.
- Avoid accidentally pulling the cord during normal operation. Loss of engine power means the loss of most steering control. Also, without engine power, the boat could slow rapidly. This could cause people and objects in the boat to be thrown forward.

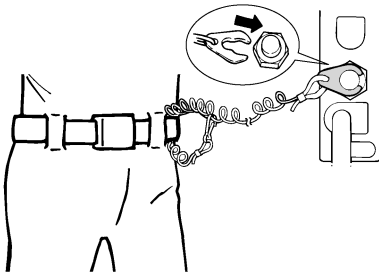

ZMU01772

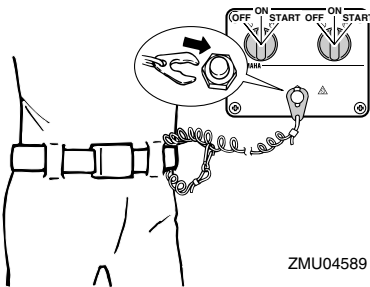

ZMU04589

3. Turn the main switch to "ON" (on).

NOTE:

Dual engine users: When the main switch is

turned on, the buzzer operates for a few seconds then stops automatically. The buzzer also operates if one of the engines stalls.

4. Turn the main switch to "START" (start), and hold it for a maximum of 5 seconds.

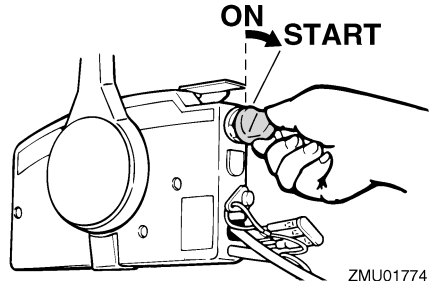

ZMU01774

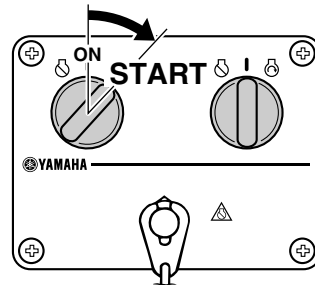

ZMU04590

5. Immediately after the engine starts, release the main switch to return it to "ON" (on).

ECM00191

CAUTION:

- Never turn the main switch to "START" (start) while the engine is running.
- Do not keep the starter motor turning for more than 5 seconds. If the starter motor is turned continuously for more than 5 seconds, the battery will be quickly discharged, thus making it impossible to start the engine. The starter can also be damaged. If the engine will not start after 5 seconds of cranking,

return the main switch to “ON” (on), wait 10 seconds, then crank the engine again.

EMU27670

Warming up engine

EMU27710

Manual start and electric start models

1. After starting the engine, allow it to idle for 3 minutes to warm up. Failure to do so will shorten engine life.
2. Be sure the low oil pressure warning indicator goes off after starting the engine.
3. Check for a steady flow of water from the cooling water pilot hole.

ECM00210

CAUTION:

- If the low oil pressure warning indicator does not go off after the engine starts, stop the engine. Otherwise serious engine damage could occur. Check the oil level and add oil if necessary. Consult your Yamaha dealer if the cause for the low oil pressure warning indicator cannot be found.
- A continuous flow of water from the pilot hole shows that the water pump is pumping water through the cooling passages. If water is not flowing out of the pilot hole at all times while the engine is running, overheating and serious damage could occur. Stop the engine and check whether the cooling water inlet on the lower case or the cooling water pilot hole is blocked. Consult your Yamaha dealer if the problem cannot be located and corrected.

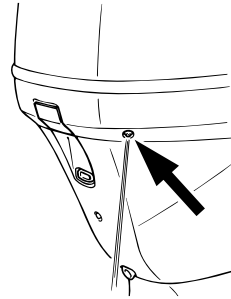

ZMU04229

EMU33492

Shifting

EWM00180

WARNING

Before shifting, make sure there are no swimmers or obstacles in the water near you.

ECM01610

CAUTION:

Warm up the engine before shifting into gear. Until the engine is warm, the idle speed may be higher than normal. High idle speed can prevent you from shifting back to neutral. If this occurs, stop the engine, shift to neutral, then restart the engine and allow it to warm up.

To shift out of neutral

1. Pull the neutral interlock trigger up (if equipped).

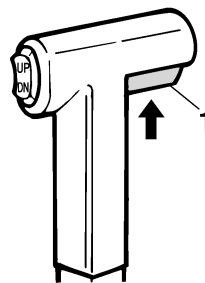

ZMU01727

1. Neutral interlock trigger

Operation

2. Move the remote control lever / gear shift lever firmly and crisply forward (for forward gear) or backward (for reverse gear) [about 35° (a detent can be felt) for remote control models].

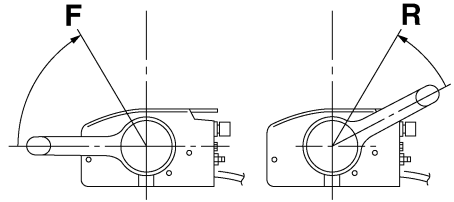
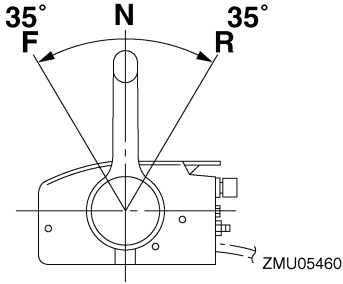

ZMU05462

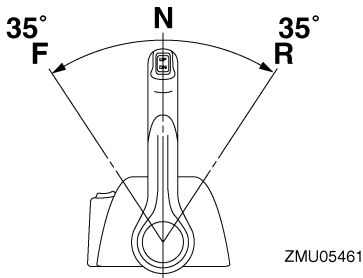

ZMU05463

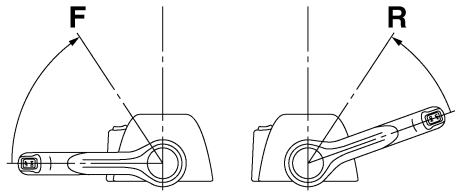

ZMU05463

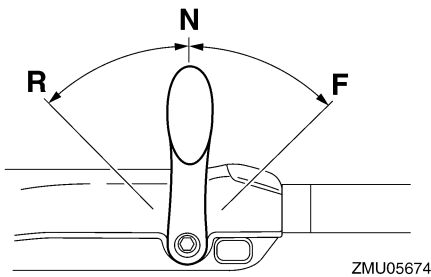

ZMU05674

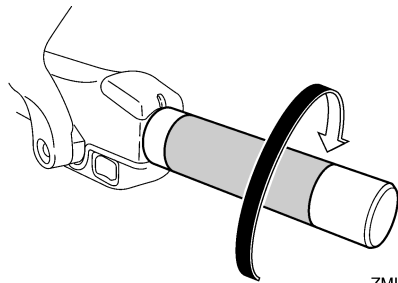

ZMU05219

2. After the engine is at idle speed in gear move the remote control lever / gear shift lever firmly and crisply into the neutral position.

To shift from in gear (forward/reverse) to neutral

1. Close the throttle so that the engine slows to idle speed.

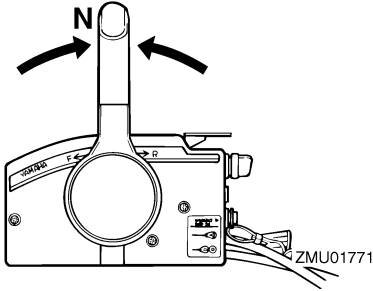

ZMU01771

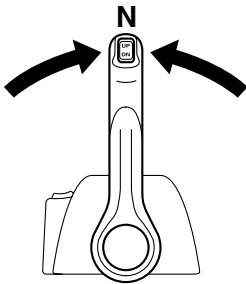

ZMU04588

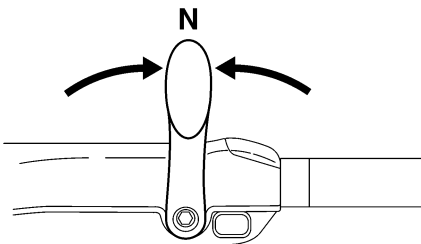

ZMU05215

EMU31742

Stopping boat

EWM01510

WARNING

- Do not use the reverse function to slow down or stop the boat as it could cause you to lose control, be ejected, or impact the steering wheel or other parts of the boat. This could increase the risk of serious injury. It could also damage the

shift mechanism.

- Do not shift into reverse while traveling at planing speeds. Loss of control, boat swamping, or damage to the boat could occur.

The boat is not equipped with a separate braking system. Water resistance stops it after the throttle lever is moved back to idle. The stopping distance varies depending on gross weight, water surface conditions, and wind direction.

EMU27820

Stopping engine

Before stopping the engine, first let it cool off for a few minutes at idle or low speed. Stopping the engine immediately after operating at high speed is not recommended.

EMU27845

Procedure

1. Push and hold the engine stop button or turn the main switch to "OFF" (off).

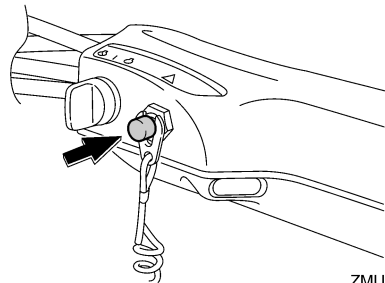

ZMU05209

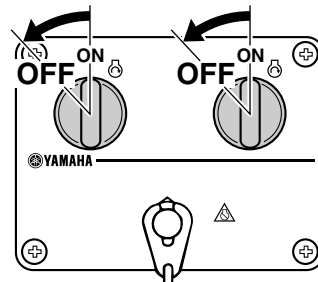

ZMU04600

Operation

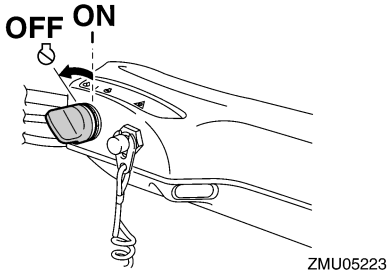
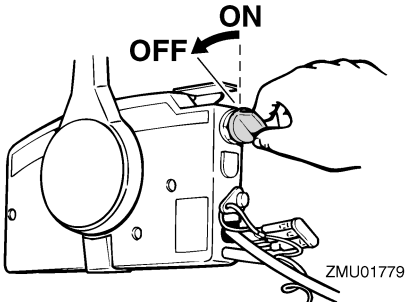

2. After stopping the engine, disconnect the fuel line if there is a fuel joint on the outboard motor.
3. Tighten the air vent screw on the fuel tank cap (if equipped).
4. Remove the key if the boat will be left unattended.

NOTE:

The engine can also be stopped by pulling the cord and removing the clip from the engine shut-off switch, then turning the main switch to "OFF" (off).

EMU27861

Trimming outboard motor

The trim angle of the outboard motor helps determine the position of the bow of the boat in the water. Correct trim angle will help improve performance and fuel economy while reducing strain on the engine. Correct trim angle depends upon the combination of

boat, engine, and propeller. Correct trim is also affected by variables such as the load in the boat, sea conditions, and running speed.

EWM00740

WARNING

Excessive trim for the operating conditions (either trim up or trim down) can cause boat instability and can make steering the boat more difficult. This increases the possibility of an accident. If the boat begins to feel unstable or is hard to steer, slow down and/or readjust the trim angle.

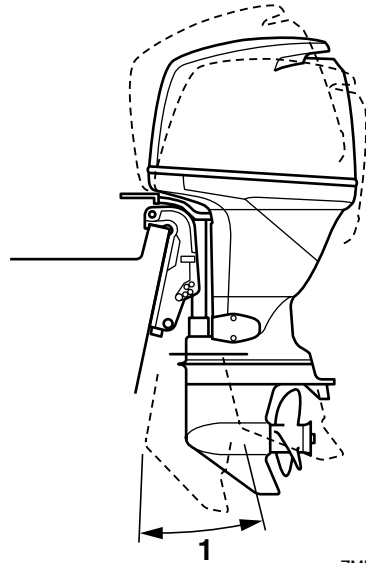

1. Trim operating angle

EMU27883

Adjusting trim angle (Power trim and tilt)

EWM00752

WARNING

- Be sure all people are clear of the out-

board motor when adjusting the tilt angle. Body parts can be crushed between the motor and the clamp bracket when the motor is trimmed or tilted.

- Use caution when trying a trim position for the first time. Increase speed gradually and watch for any signs of instability or control problems. Improper trim angle can cause loss of control.
- If equipped with a power trim and tilt switch located on the bottom cowling, use the switch only when the boat is at a complete stop with the engine off. Do not adjust the trim angle with this switch while the boat is moving.

Adjust the outboard motor trim angle using the power trim and tilt switch.

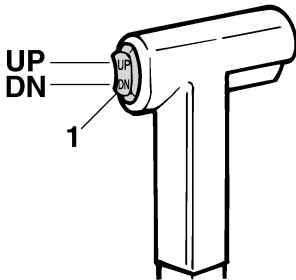

ZMU01781

1. Power trim and tilt switch

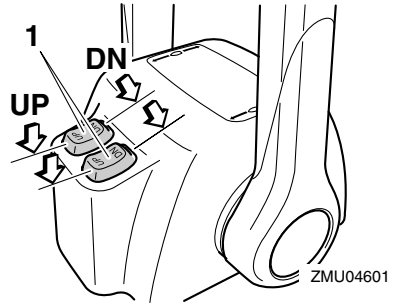

ZMU04601

1. Power trim and tilt switch

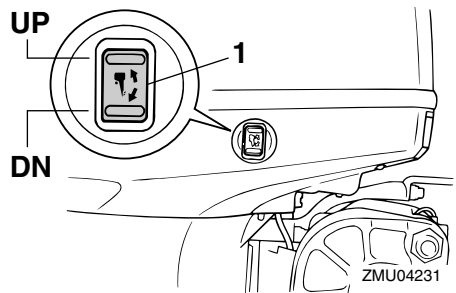

ZMU04231

1. Power trim and tilt switch

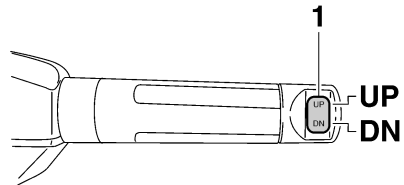

ZMU05224

1. Power trim and tilt switch

To raise the bow (trim-out), press the switch "UP" (up).

To lower the bow (trim-in), press the switch "DN" (down).

Make test runs with the trim set to different

Operation

angles to find the position that works best for your boat and operating conditions.

EMU27911

Adjusting boat trim

When the boat is on plane, a bow-up attitude results in less drag, greater stability and efficiency. This is generally when the keel line of the boat is up about 3 to 5 degrees. With the bow up, the boat may have a greater tendency to steer to one side or the other. Compensate for this as you steer. The trim tab can also be adjusted to help offset this effect. When the bow of the boat is down, it is easier to accelerate from a standing start onto plane.

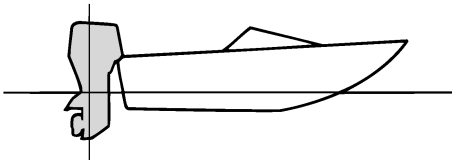

ZMU01784

Bow Up

Too much trim-out puts the bow of the boat too high in the water. Performance and economy are decreased because the hull of the boat is pushing the water and there is more air drag. Excessive trim-out can also cause the propeller to ventilate, which reduces performance further, and the boat may “porpoise” (hop in the water), which could throw the operator and passengers overboard.

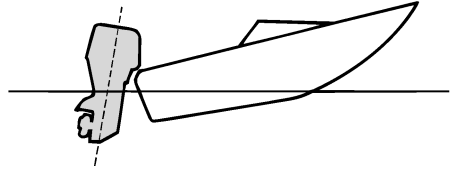

ZMU01785

Bow Down

Too much trim-in causes the boat to “plow” through the water, decreasing fuel economy and making it hard to increase speed. Operating with excessive trim-in at higher speeds also makes the boat unstable. Resistance at the bow is greatly increased, heightening the danger of “bow steering” and making operation difficult and dangerous.

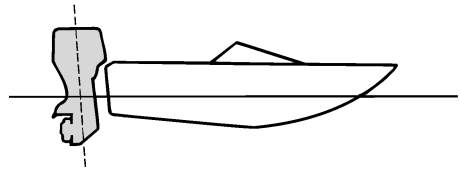

ZMU01786

NOTE:

Depending on the type of boat, the outboard motor trim angle may have little effect on the trim of the boat when operating.

EMU27934

Tilting up and down

If the engine will be stopped for some time or if the boat is moored in shallows, the outboard motor should be tilted up to protect the propeller and lower casing from damage by collision with obstructions, and also to re-

duce salt corrosion.

EWM00221

WARNING

Be sure all people are clear of the outboard motor when tilting up and down. Body parts can be crushed between the motor and the clamp bracket when the motor is trimmed or tilted.

EWM00250

WARNING

Leaking fuel is a fire hazard. If there is a fuel joint on the outboard motor, disconnect the fuel line or close the fuel cock if the engine will be tilted for more than a few minutes. Otherwise fuel may leak.

ECM00241

CAUTION:

- Before tilting the outboard motor, stop the engine by following the procedure on page 47. Never tilt the outboard motor while the engine is running. Severe damage from overheating can result.
- Do not tilt up the engine by pushing the tiller handle (if equipped) because this could break the handle.

EMU32721

Procedure for tilting up (power trim and tilt models)

1. Place the remote control lever / gear shift lever in neutral.

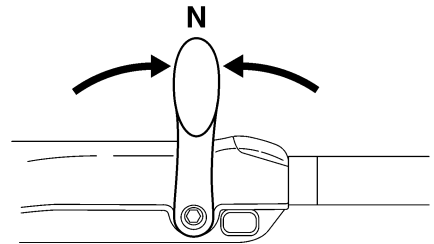
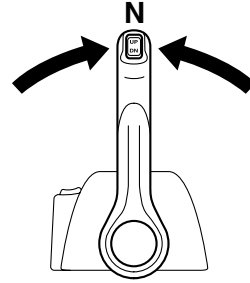
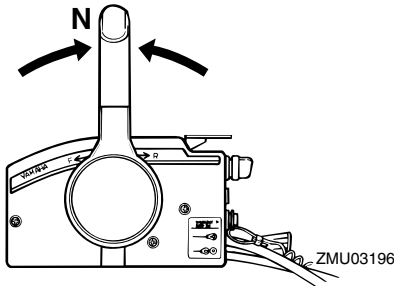

2. Press the power trim and tilt switch "UP" (up) until the outboard motor has tilted up completely.

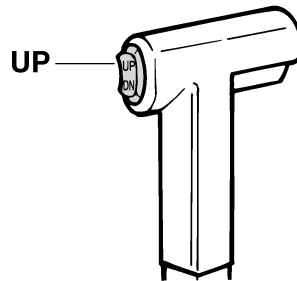

Operation

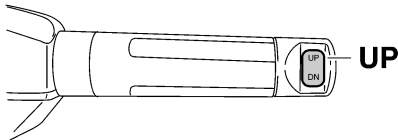
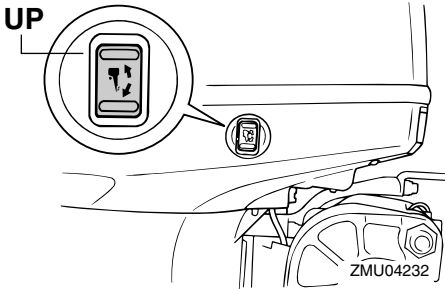
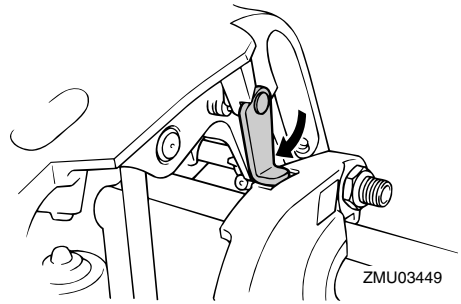
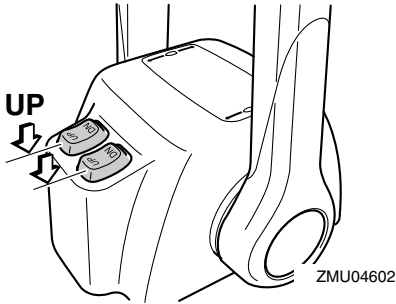

3. Pull the tilt support lever toward you to support the engine.

EWM00260

WARNING

After tilting the outboard motor, be sure to support it with the tilt support knob or tilt support lever. Otherwise the outboard motor could fall back down suddenly if oil in the power trim and tilt unit loses pressure.

ECM01640

CAUTION:

Do not use the tilt support lever or knob when trailering the boat. The outboard motor could shake loose from the tilt support and fall. If the motor cannot be trailered in the normal running position, use an additional support device to secure it in the tilt position. For more detailed information, see page 57.

4. Models equipped with trim rods: Once the outboard motor is supported with the tilt support lever, press the power trim and tilt switch "DN" (down) to retract the trim rods.

ECM00250

CAUTION:

Be sure to retract the trim rods completely during mooring. This protects the rods from marine growth and corrosion which could damage the power trim and tilt mechanism.

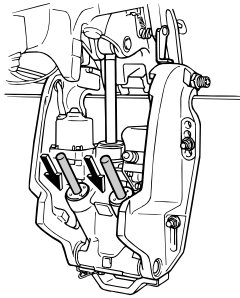

ZMU03452

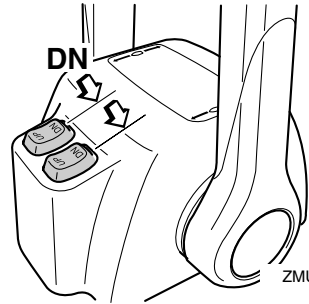

ZMU04603

EMU33120

Procedure for tilting down (power trim and tilt models)

1. Push the power trim and tilt switch “UP” (up) until the outboard motor is supported by the tilt rod and the tilt support lever becomes free.
2. Release the tilt support lever.

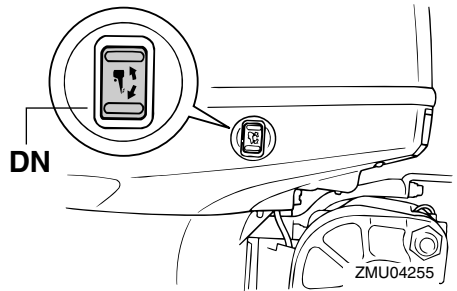

ZMU04255

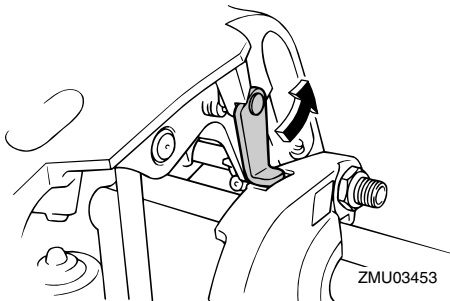

ZMU03453

3. Push the power trim and tilt switch “DN” (down) to lower the outboard motor to the desired position.

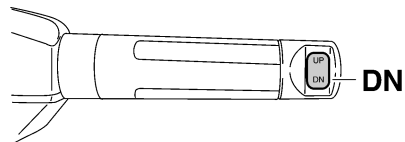

ZMU05228

EMU28060

Cruising in shallow water

The outboard motor can be tilted up partially to allow operation in shallow water.

EMU32850

Power trim and tilt models

The outboard motor can be tilted up partially to allow operation in shallow water.

EWM00660



- Place the gear shift in neutral before

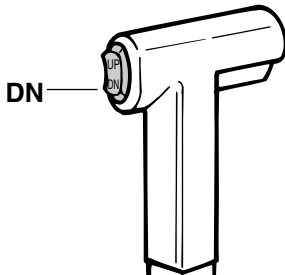

ZMU01936

Operation

setting up for shallow water cruising.

- Return the outboard motor to its normal position as soon as the boat is back in deeper water.

ECM00260

CAUTION:

Do not tilt the outboard motor up so that the cooling water inlet on the lower unit is above the surface of the water when setting up for and cruising in shallow water. Otherwise severe damage from overheating can result.

EMU32910

Procedure for power trim and tilt

1. Place the remote control lever / gear shift lever in neutral.

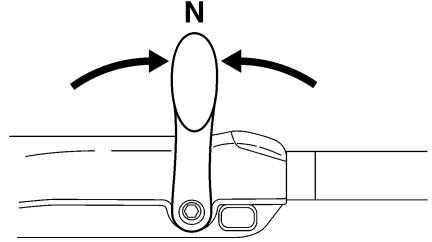
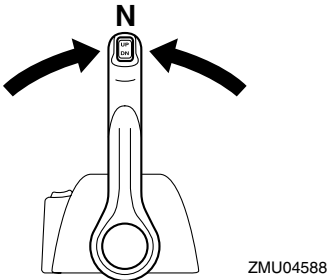
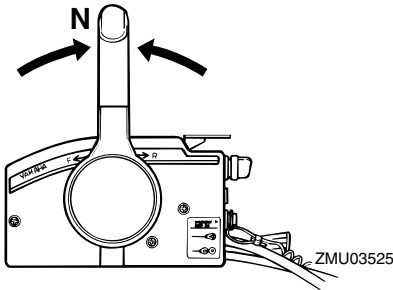

2. Slightly tilt the outboard motor up to the desired position using the power trim and tilt switch.

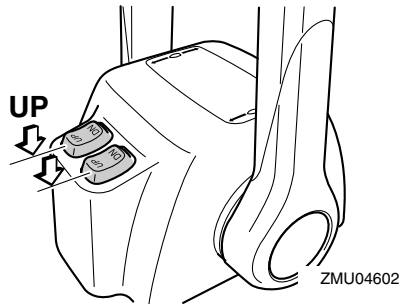
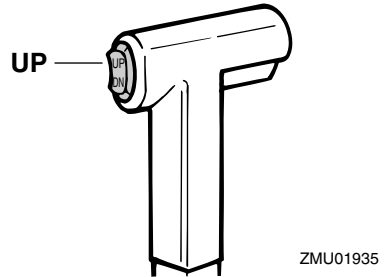

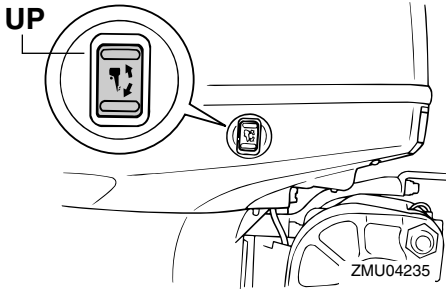

Cruising in acidic water

Water in some areas can be acidic. After operating in such water, flush the cooling passages with fresh water to prevent corrosion. Also rinse the outside of the outboard motor with fresh water.

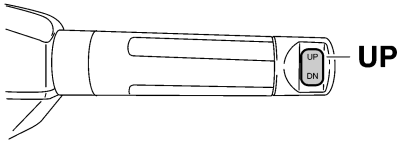

ZMU05226

3. To return the outboard motor to the normal running position, press the power trim and tilt switch and slowly tilt the outboard motor down.

EMU28193

Cruising in other conditions

Cruising in salt water

After operating in salt water, flush the cooling water passages with fresh water to prevent them from becoming clogged. Also rinse the outside of the outboard motor with fresh water and, if possible, rinse the power head under the cowling.

Cruising in muddy or turbid water

Yamaha strongly recommends that you use the optional chromium-plated water pump kit (available for V4 and large engines) if you use the outboard motor in water with a lot of sediment in it, such as muddy or other turbid (cloudy) water.

Maintenance

EMU34520

Specifications

NOTE: _____

“(AL)” stated in the specification data below represents the numerical value for the aluminum propeller installed.

Likewise, “(SUS)” represents the value for stainless steel propeller installed and “(PL)” for plastic propeller installed.

NOTE: _____

“**” means, select the engine oil referring to the chart of engine oil paragraph. For further information, see page 9.

EMU28219

Dimension:

- Overall length:
825 mm (32.5 in)
- Overall width:
498 mm (19.6 in)
- Overall height L:
F115AET 1609 mm (63.3 in)
- Overall height X:
1736 mm (68.3 in)
- Transom height L:
F115AET 516 mm (20.3 in)
- Transom height X:
643 mm (25.3 in)
- Weight (AL) L:
F115AET 186.0 kg (410 lb)
- Weight (AL) X:
F115AET 191.0 kg (421 lb)
- Weight (SUS) L:
F115AET 188.0 kg (414 lb)
- Weight (SUS) X:
193.0 kg (425 lb)

Performance:

- Full throttle operating range:
5000–6000 r/min
- Maximum output:

84.6 kW @ 5500 r/min (115 HP @ 5500 r/min)

Idling speed (in neutral):
750 ±50 r/min

Engine:

- Type:
4-stroke L
- Displacement:
1741.0 cm³
- Bore × stroke:
79.0 × 88.8 mm (3.11 × 3.50 in)
- Ignition system:
TCI
- Spark plug (NGK):
LFR6A-11
- Spark plug gap:
1.0–1.1 mm (0.039–0.043 in)
- Control system:
Remote control
- Starting system:
Electric
- Starting carburetion system:
Electronic fuel injection
- Valve clearance (cold engine) IN:
0.17–0.23 mm (0.0067–0.0091 in)
- Valve clearance (cold engine) EX:
0.31–0.37 mm (0.0122–0.0146 in)
- Min. cold cranking amps (CCA/EN):
430.0 A
- Min. rated capacity (20HR/IEC):
70.0 Ah
- Maximum generator output:
25.0 A

Drive unit:

- Gear positions:
Forward-neutral-reverse
- Gear ratio:
2.15 (28/13)
- Trim and tilt system:
Power trim and tilt
- Propeller mark:

F115AET K
FL115AET KL

Fuel and oil:

Recommended fuel:

Regular unleaded gasoline

Min. research octane:

90

Recommended engine oil:

4-stroke outboard motor oil

Recommended engine oil group 1*:

SAE 10W-30/10W-40/5W-30

API SE/SF/SG/SH/SJ/SL

Recommended engine oil group 2*:

SAE 15W-40/20W-40/20W-50

API SH/SJ/SL

Lubrication:

Wet sump

Engine oil quantity (excluding oil filter):

4.3 L (4.55 US qt) (3.78 Imp.qt)

Recommended gear oil:

Hypoid gear oil SAE#90

Gear oil quantity:

F115AET 760.0 cm³ (25.70 US oz)
(26.81 Imp.oz)

FL115AET 715.0 cm³ (24.17 US oz)
(25.22 Imp.oz)

Tightening torque for engine:

Spark plug:

25.0 Nm (18.4 ft-lb) (2.55 kgf-m)

Propeller nut:

55.0 Nm (40.6 ft-lb) (5.61 kgf-m)

Engine oil drain bolt:

28.0 Nm (20.7 ft-lb) (2.86 kgf-m)

Engine oil filter:

18.0 Nm (13.3 ft-lb) (1.84 kgf-m)

Noise and vibration level:

Operator sound pressure level (ICOMIA
39/94 and 40/94):

75.5 dB(A)

EMU28223

Transporting and storing outboard motor

EWM00690



- **Leaking fuel is a fire hazard. When transporting and storing the outboard motor, close the air vent screw and fuel cock to prevent fuel from leaking.**
- **USE CARE when transporting fuel tank, whether in a boat or car.**
- **DO NOT fill fuel container to maximum capacity. Gasoline will expand considerably as it warms up and can build up pressure in the fuel container. This can cause fuel leakage and a potential fire hazard.**

EWM00700



Never get under the lower unit while it is tilted, even if a motor support bar is used. Severe injury could occur if the outboard motor accidentally falls.

ECM00660



Do not use the tilt support lever or knob when trailering the boat. The outboard motor could shake loose from the tilt support and fall. If the motor cannot be trailered in the normal running position, use an additional support device to secure it in the tilt position.

The outboard motor should be trailered and stored in the normal running position. If there is insufficient road clearance in this position, then trailer the outboard motor in the tilt position using a motor support device such as a transom saver bar. Consult your Yamaha dealer for further details.

Maintenance

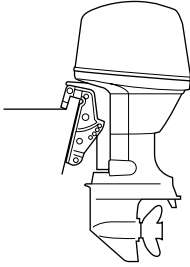

ZMU03659

EMU28290

Storing outboard motor

When storing your Yamaha outboard motor for prolonged periods of time (2 months or longer), several important procedures must be performed to prevent excessive damage. It is advisable to have your outboard motor serviced by an authorized Yamaha dealer prior to storage. However, you, the owner, with a minimum of tools, can perform the following procedures.

ECM00600

CAUTION:

- To prevent problems which can be caused by oil entering the cylinder from the sump, keep the outboard motor in the attitude shown when transporting and storing it. If storing or transporting the outboard motor on its side (not upright), put it on a cushion after draining the engine oil.
- Do not place the outboard motor on its side before the cooling water has drained from it completely, otherwise water may enter the cylinder through the exhaust port and cause engine trouble.
- Store the outboard motor in a dry, well-ventilated place, not in direct sunlight.
- Drain the remaining gasoline from the vapor separator. Gasoline left in the va-

por separator for a prolonged period of time will break down and could cause damage to the fuel line.

EMU28303

Procedure

EMU29953

Flushing with the flushing attachment

1. Wash the outboard motor body using fresh water. For further information, see page 61.
2. Disconnect the fuel line from the motor or shut off the fuel cock, if equipped.
3. Remove the top cowling and propeller.
4. Install the flushing attachment over the cooling water inlet.

ECM00300

CAUTION:

Do not run the engine without supplying it with cooling water. Either the engine water pump will be damaged or the engine will be damaged from overheating. Before starting the engine, be sure to supply water to the cooling water passages.

ECM00310

CAUTION:

Avoid running the outboard motor at high speed while on the flushing attachment, otherwise overheating could occur.

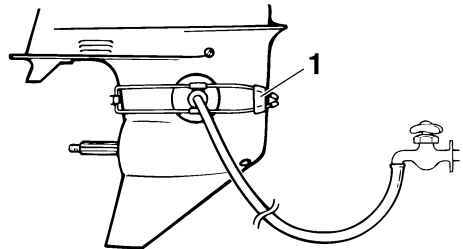

ZMU01830

1. Flushing attachment

5. Cooling system flushing is essential to prevent the cooling system from clogging up with salt, sand, or dirt. In addition, fogging/lubricating the engine is mandatory to prevent excessive engine damage due to rust. Perform the flushing and fogging at the same time.

EWM00090

WARNING

- Do not touch or remove electrical parts when starting or during operation.
- Keep hands, hair, and clothes away from the flywheel and other rotating parts while the engine is running.

NOTE:

- When using the flushing attachment, maintain adequate water pressure and a steady water flow.
 - If the overheat warning device is activated, turn the engine off, and consult your Yamaha dealer.
6. Run the engine at a fast idle for a few minutes in neutral position.
 7. Just prior to turning off the engine, quickly spray “Fogging Oil” alternately into the intake silencer or the fogging hole of the silencer cover, if equipped. When properly done, the engine will smoke excessively and almost stall.
 8. Drain the remained gasoline in the vapor separator with a container. Loosen the drain screw, and then remove the cap. Push in the air valve with a screwdriver to introduce air into the float chamber, so that the gasoline will drain smoothly. Then, tighten the drain screw.

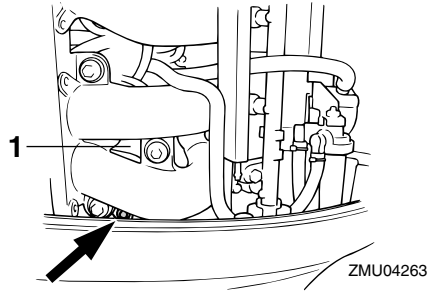

1. Vapor separator

9. Remove the flushing attachment.
10. Install the top cowl.
11. If “Fogging Oil” is not available, turn off the engine after the 6 step. Then perform the 8 step procedure.
12. Drain the cooling water completely out of the motor. Clean the body thoroughly.
13. If the “Fogging Oil” is not available, remove the spark plug(s). Pour a teaspoonful of clean engine oil into each cylinder. Crank several times manually. Replace the spark plug(s).

NOTE:

A flushing attachment is available from your Yamaha dealer.

EMU28402

Lubrication

1. Install the spark plug(s) and torque to proper specification. For information on spark plug installation, see page 66.
2. Change the gear oil. For instructions, see page 73. Inspect the oil for the presence of water that indicates a leaky seal. Seal replacement should be performed by an authorized Yamaha dealer prior to use.
3. Grease all grease fittings. For further details, see page 66.

Maintenance

NOTE: _____

For long-term storage, fogging the engine with oil is recommended. Contact your Yamaha dealer for information about fogging oil and procedures for your engine.

EMU28431

Battery care

EWM00330



Battery electrolytic fluid is dangerous; it contains sulfuric acid and therefore is poisonous and highly caustic.

Always follow these preventive measures:

- **Avoid bodily contact with electrolytic fluid as it can cause severe burns or permanent eye injury.**
- **Wear protective eye gear when handling or working near batteries.**

Antidote (EXTERNAL):

- **SKIN - Flush with water.**
- **EYES - Flush with water for 15 minutes and get immediate medical attention.**

Antidote (INTERNAL):

- **Drink large quantities of water or milk followed by milk of magnesia, beaten egg, or vegetable oil. Get immediate medical attention.**

Batteries also generate explosive hydrogen gas; therefore, you should always follow these preventive measures:

- **Charge batteries in a well-ventilated area.**
- **Keep batteries away from fire, sparks, or open flames (for example: welding equipment, lighted cigarettes, and so on.)**
- **DO NOT SMOKE when charging or handling batteries.**

KEEP BATTERIES AND ELECTROLYTIC

FLUID OUT OF REACH OF CHILDREN.

Follow the manual of the battery for the handling of the battery. Batteries vary among manufacturers. Therefore the following procedures may not always apply. Consult your battery manufacturer's instructions.

Procedure

1. **Disconnect and remove the battery from the boat. Always disconnect the black negative cable first to prevent the risk of shorting.**
2. **Clean the battery casing and terminals. Fill each cell to the upper level with distilled water.**
3. **Store the battery on a level surface in a cool, dry, well-ventilated place out of direct sunlight.**
4. **Once a month, check the specific gravity of the electrolyte and recharge as required to prolong battery life.**

EMU28442

Flushing power unit

Perform this procedure right after operation for the most thorough flushing.

ECM01530

CAUTION: _____

Do not perform this procedure while the engine is running. The water pump may be damaged and severe damage from overheating can result.

1. **After shutting off the engine, unscrew the garden hose connector from the fitting on the bottom cowling.**

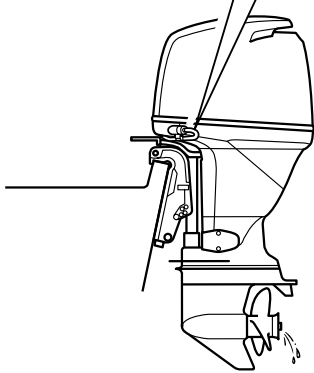
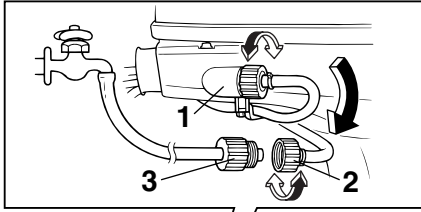

ZMU04264

1. Fitting
2. Garden hose connector
3. Garden hose adapter

2. Screw the garden hose adapter onto a garden hose, which is connected to a fresh water supply, and then connect it to the garden hose connector.
3. With the engine off, turn on the water tap and let the water flush through the cooling passages for about 15 minutes. Turn off the water and disconnect the garden hose adapter from the garden hose connector.
4. Reinstall the garden hose connector onto the fitting on the bottom cowling. Tighten the connector securely.

ECM00540

CAUTION:

Do not leave the garden hose connector loose on the bottom cowling fitting or let the hose hang free during normal opera-

tion. Water will leak out of the connector instead of cooling the engine, which can cause serious overheating. Be sure the connector is tightened securely on the fitting after flushing the engine.

NOTE:

- When flushing the engine with the boat in the water, tilting up the outboard motor until it is completely out of the water will achieve better results.
- For cooling system flushing instructions, see page 57.

EMU28450

Cleaning the outboard motor

After use, wash the exterior of the outboard motor with fresh water. Flush the cooling system with fresh water.

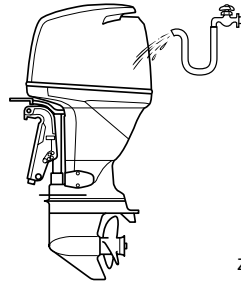

ZMU04265

NOTE:

For cooling system flushing instructions, see page 57.

EMU28460

Checking painted surface of motor

Check the motor for scratches, nicks, or flaking paint. Areas with damaged paint are more likely to corrode. If necessary, clean and paint the areas. A touch-up paint is available from your Yamaha dealer.

Maintenance

EMU28478

Periodic maintenance

EWM01071



Be sure to turn off the engine when you perform maintenance unless otherwise specified. If you are not familiar with machine servicing, this work should be done by your Yamaha dealer or other qualified mechanic.

EMU28511

Replacement parts

If replacement parts are necessary, use only genuine Yamaha parts or parts of equivalent design and quality. Any part of inferior quality may malfunction, and the resulting loss of control could endanger the operator and passengers. Yamaha genuine parts and accessories are available from your Yamaha dealer.

EMU34150

Severe operating conditions

Severe operating conditions involve one or more of the following types of operation on a regular basis:

- Operating continuously at or near maximum engine speed (rpm) for many hours
- Operating continuously at a low engine speed (rpm) for many hours
- Brief periods of rapid acceleration and deceleration followed by engine shut off before the engine has reached proper operating temperature
- Frequent quick acceleration and deceleration
- Frequent shifting
- Frequently starting and stopping the engine(s)
- Operation that fluctuates often between light and heavy cargo loads

Outboard motors operating under any of

these above conditions require more frequent maintenance. Yamaha recommends that you do this service twice as often as specified in the maintenance chart. For example, if a particular service should be done at 50 hours, do it instead at 25 hours. This will help prevent more rapid deterioration of engine components.

EMU34443

Maintenance chart 1

NOTE:

- Refer to the sections in this chapter for explanations of each owner-specific action.
- The maintenance cycle on these charts assume usage of 100 hours per year and regular flushing of the cooling water passages. Maintenance frequency should be adjusted when operating the engine under adverse conditions such as extended trolling.
- Disassembly or repairs may be necessary depending on the outcome of maintenance checks.
- Expendable or consumable parts and lubricants will lose their effectiveness over time and through normal usage regardless of the warranty period.
- When operating in salt water, muddy, other turbid (cloudy), acidic water, the engine should be flushed with clean water after each use.

The “●” symbol indicates the check-ups which you may carry out yourself.

The “○” symbol indicates work to be carried out by your Yamaha dealer.

Item	Actions	Initial	Every		
		20 hours (3 months)	100 hours (1 year)	300 hours (3 years)	500 hours (5 years)
Anode(s) (external)	Inspection or replacement as necessary		●/○		
Anode(s) (cylinder head, thermostat cover)	Inspection or replacement as necessary		○		
Anodes (exhaust cover, cooling water passage cover, Rectifier Regulator cover)	Replacement				○
Anode(s) (exhaust cover, cover joint)	Replacement				○
Battery	Inspection or charging, replacement as necessary	●/○	●/○		
Cooling water leakage	Inspection or replacement as necessary	○	○		
Cowling clamp	Inspection		●/○		
Engine starting condition/Noise	Inspection	●/○	●/○		
Engine idling speed/Noise	Inspection	●/○	●/○		
Engine oil	Replacement	●/○	●/○		

Maintenance

Item	Actions	Initial	Every		
		20 hours (3 months)	100 hours (1 year)	300 hours (3 years)	500 hours (5 years)
Engine Oil filter (cartridge)	Replacement		●/○		
Fuel filter (can be disassembled)	Inspection or replacement as necessary	●/○	●/○		
Fuel filter (vapor separator tank)	Replacement				○
Fuel pump	Inspection or replacement as necessary			○	
Fuel/oil leakage	Inspection	○	○		
Fuel pipe	Inspection or replacement as necessary	○	○		
Fuel pipe	Replacement			○	
Gear oil	Replacement	●/○	●/○		
Greasing points	Greasing	●/○	●/○		
Impeller/water pump housing	Inspection or replacement as necessary		○		
Impeller/water pump housing	Inspection or replacement as necessary			○	
Power trim/tilt unit	Inspection	●/○	●/○		
Propeller/Propeller nut/Cotter pin	Inspection or replacement as necessary	●/○	●/○		
PCV (Pressure Control Valve)	Inspection or replacement as necessary		○		
Shift link/shift cable	Inspection, adjustment or replacement as necessary	○	○		
Spark plug(s)	Inspection, adjustment or replacement as necessary		●/○		
Spark plug caps/high tension cordes	Inspection or replacement as necessary	○	○		
Pilot water	Inspection	●/○	●/○		
Throttle link/Throttle cable/Throttle pick-up timing	Inspection, adjustment or replacement as necessary	○	○		
Thermostat	Inspection or replacement as necessary		○		
Timing belt	Inspection or replacement as necessary		○		

Maintenance

Item	Actions	Initial	Every		
		20 hours (3 months)	100 hours (1 year)	300 hours (3 years)	500 hours (5 years)
Valve clearance	Inspection and adjustment				○
Water inlet	Inspection	●/○	●/○		
Main switch/stop switch/choke switch	Inspection or replacement as necessary	○	○		
Wire harness connections/Wire coupler connections	Inspection or replacement as necessary	○	○		
(Yamaha) Meter/gauge	Inspection	○	○		

EMU34450

Maintenance chart 2

Item	Actions	Every
		1000 hours
Guide exhaust/exhaust manifold	Inspection or replacement as necessary	○
Timing belt	Replacement	○

EMU28910

NOTE:

When using lead or high-sulfur gasoline, inspecting valve clearance may be required more frequently than every 500 hours.

Maintenance

EMU28941

Greasing

Yamaha grease A (water resistant grease)

Yamaha grease D (corrosion resistant grease; for propeller shaft)

F115A, FL115A

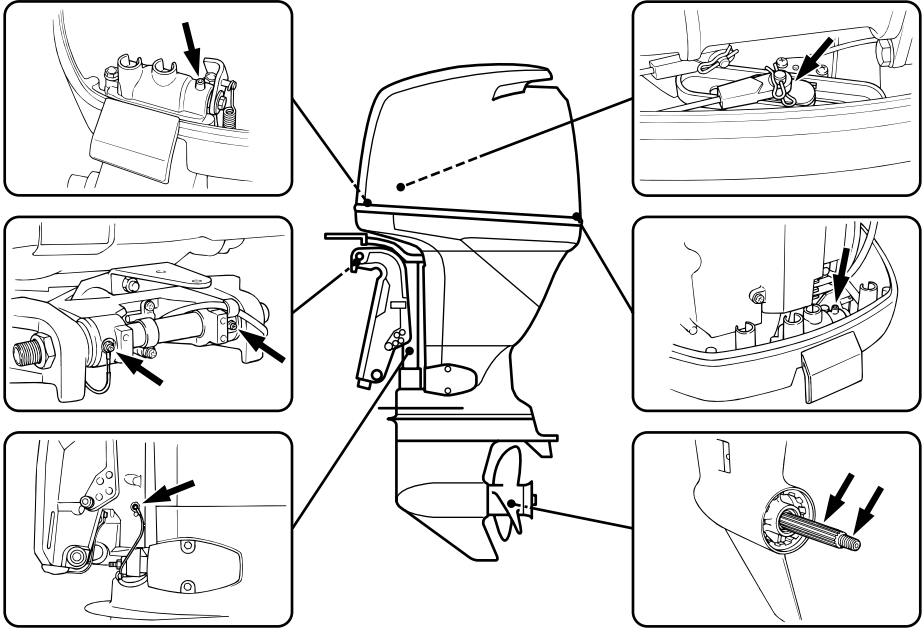

ZMU04266

EMU28953

Cleaning and adjusting spark plug

EWM00560

WARNING

When removing or installing a spark plug, be careful not to damage the insulator. A damaged insulator could allow external sparks, which could lead to explosion or fire.

EWM01550

WARNING

The engine will still be very hot when it has just been turned off. Take extremely care so that neither you nor anyone else gets burnt. To avoid burns, work on the

engine when it has cooled down.

The spark plug is an important engine component and is easy to inspect. The condition of the spark plug can indicate something about the condition of the engine. For example, if the center electrode porcelain is very white, this could indicate an intake air leak or carburetion problem in that cylinder. Do not attempt to diagnose any problems yourself. Instead, take the outboard motor to a Yamaha dealer. You should periodically remove and inspect the spark plug because heat and deposits will cause the spark plug to slowly break down and erode. If electrode erosion becomes excessive, or if carbon and

other deposits are excessive, you should replace the spark plug with another of the correct type.

Standard spark plug:
LFR6A-11

Before fitting the spark plug, measure the electrode gap with a wire thickness gauge; adjust the gap to specification if necessary.

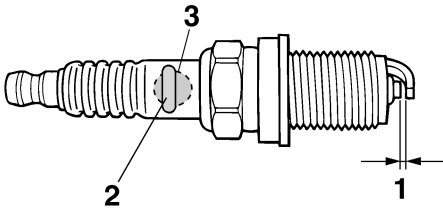

ZMU01797

1. Spark plug gap
2. Spark plug I.D. mark (NGK)
3. Spark plug part number

Spark plug gap:
1.0–1.1 mm (0.039–0.043 in)

When fitting the plug, always clean the gasket surface and use a new gasket. Wipe off any dirt from the threads and screw in the spark plug to the correct torque.

Spark plug torque:
25.0 Nm (18.4 ft-lb) (2.55 kgf-m)

NOTE:

If a torque-wrench is not available when you are fitting a spark plug, a good estimate of the correct torque is 1/4 to 1/2 a turn past finger-tight. Have the spark plug adjusted to the correct torque as soon as possible with a torque-wrench.

EMU28962

Checking fuel system

EWM00060



Gasoline and its vapors are highly flammable and explosive. Keep away from sparks, cigarettes, flames, or other sources of ignition.

EWM00910



Leaking fuel can result in fire or explosion.

- Check for fuel leakage regularly.
- If any fuel leakage is found, the fuel system must be repaired by a qualified mechanic. Improper repairs can make the outboard unsafe to operate.

Check the fuel lines for leaks, crack, or malfunction. If a problem is found, your Yamaha dealer or other qualified mechanic should repair it immediately.

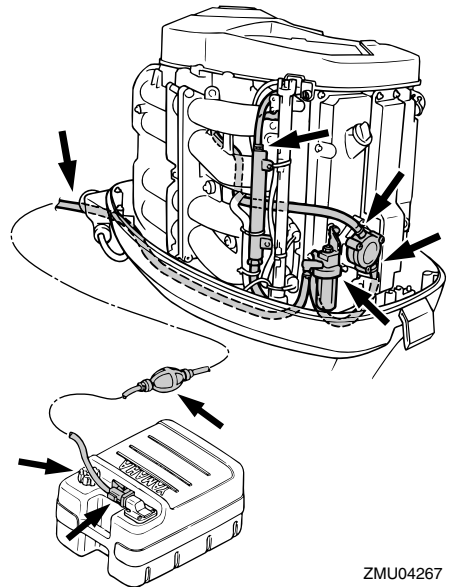

ZMU04267

Maintenance

Checkpoints

- Fuel system parts leakage
- Fuel line joint leakage
- Fuel line cracks or other damage
- Fuel connector leakage

EMU29041

Inspecting idling speed

EWM00451



- Do not touch or remove electrical parts when starting or during operation.
- Keep hands, hair, and clothes away from the flywheel and other rotating parts while the engine is running.

ECM00490

CAUTION:

This procedure must be performed while the outboard motor is in the water. A flushing attachment or test tank can be used.

A diagnostic tachometer should be used for this procedure. Results may vary depending on whether testing is conducted with the flushing attachment, in a test tank, or with the outboard motor in the water.

1. Start the engine and allow it to warm up fully in neutral until it is running smoothly.

NOTE:

Correct idling speed inspection is only possible if the engine is fully warmed up. If not warmed up fully, the idle speed will measure higher than normal. If you have difficulty verifying the idle speed, or the idle speed requires adjustment, consult a Yamaha dealer or other qualified mechanic.

2. Verify whether the idle speed is set to specification. For idle speed specifications, see page 56.

EMU29075

Changing engine oil

EWM00760



- Avoid draining the engine oil immediately after stopping the engine. The oil is hot and should be handled with care to avoid burns.
- Be sure the outboard motor is securely fastened to the transom or a stable stand.

ECM00970

CAUTION:

- Do not overfill the oil, and be sure the outboard motor is upright (not tilted) when checking and changing the engine oil.
- If the oil level is above the upper level mark, drain until the level meets the specified capacity. Overfilling the oil could cause leakage or damage.

ECM01710

CAUTION:

Change the engine oil after the first 20 hours of operation or 3 months, and every 100 hours or at 1-year intervals thereafter. Otherwise the engine will wear quickly.

NOTE:

Change the engine oil when the oil is still warm.

1. Put the outboard motor in an upright position (not tilted).

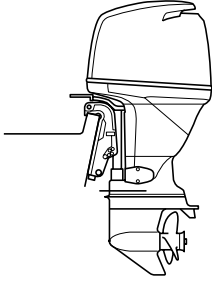

ZMU04270

2. Prepare a suitable container that holds a larger amount than the engine oil capacity. Loosen and remove the drain screw while holding the container under the drain hole. Then remove the oil filler cap. Let the oil drain completely. Wipe up any spilled oil immediately.

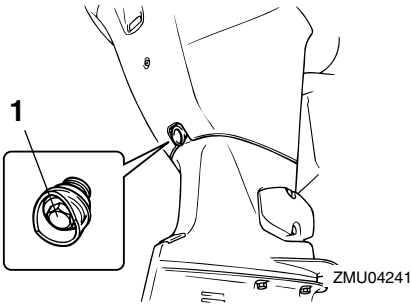

ZMU04241

1. Drain screw

3. Put a new gasket on the oil drain screw. Apply a light coat of oil to the gasket and install the drain screw.

Drain screw tightening torque:
28.0 Nm (20.7 ft-lb) (2.86 kgf-m)

NOTE:

If a torque wrench is not available when you are installing the drain screw, finger tighten the screw just until the gasket comes into contact with the surface of the drain hole.

Then tighten 1/4 to 1/2 turn more. Tighten the drain screw to the correct torque with a torque wrench as soon as possible.

4. Add the correct amount of oil through the filler hole. Install the filler cap.

Recommended engine oil:

4-stroke outboard motor oil

Engine oil quantity (excluding oil filter):

4.3 L (4.55 US qt) (3.78 Imp.qt)

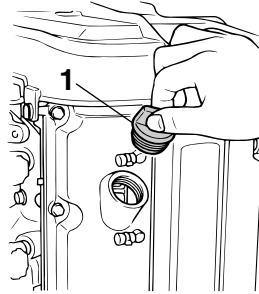

ZMU04271

1. Oil filler cap

5. Start the engine and watch to make sure the low oil pressure-warning indicator (if equipped) turns off. Make sure that there are no oil leaks.

ECM00681

CAUTION:

If the low oil pressure-warning indicator does not turn off or if there are oil leaks, stop the engine and find the cause. Continued operation with a problem could cause severe engine damage. Consult your Yamaha dealer if the problem cannot be located and corrected.

6. Turn off the engine and wait 3 minutes. Recheck the oil level using the dipstick to be sure the level falls between the upper and lower marks. Fill with oil if it is below the lower mark, or drain to the

Maintenance

specified level if it is above the upper mark.

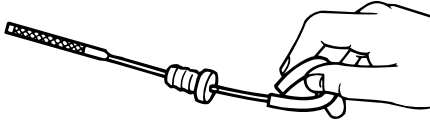

ZMU02058

7. Dispose of used oil according to local regulations.

NOTE: _____

- For more information on the disposal of used oil, consult your Yamaha dealer.
- Change the oil more often when operating the engine under adverse conditions such as extended trolling.

EMU29112

Checking wiring and connectors

- Check that each grounding wire is properly secured.
- Check that each connector is engaged securely.

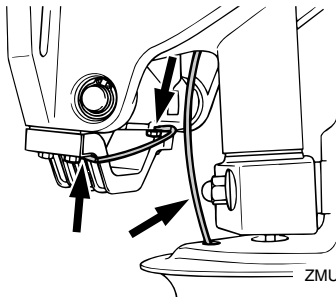

ZMU04286

EMU29120

Exhaust leakage

Start the engine and check that no exhaust leaks from the joints between the exhaust cover, cylinder head, and body cylinder.

EMU29130

Water leakage

Start the engine and check that no water leaks from the joints between the exhaust cover, cylinder head, and body cylinder.

EMU29140

Engine oil leakage

Check for oil leaks on the around the engine.

NOTE: _____

If any leaks are found, consult your Yamaha dealer.

EMU29154

Checking power trim and tilt system

EWMM00431

! WARNING _____

- **Never get under the lower unit while it is tilted, even when the tilt support lever is locked. Severe injury could occur if the outboard motor accidentally falls.**
- **Make sure no one is under the outboard motor before performing this test. Body parts can be crushed between the motor and the clamp bracket when the motor is trimmed or tilted.**

1. Check the power trim and tilt unit for any sign of oil leaks.
2. Operate each of the power trim and tilt switches on the remote control and engine bottom cowling (if equipped) to check that all switches work.
3. Tilt the outboard motor up and check that the tilt rod and trim rods are extended completely.

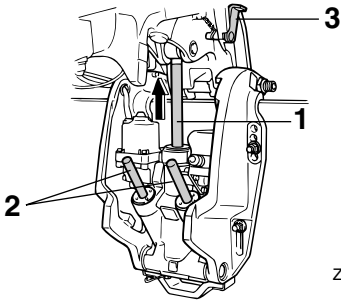

ZMU02633

1. Tilt rod
 2. Trim rods
 3. Tilt support lever
4. Use the tilt support lever to lock the motor in the up position. Operate the tilt down switch briefly so the motor is supported by the tilt support lever.

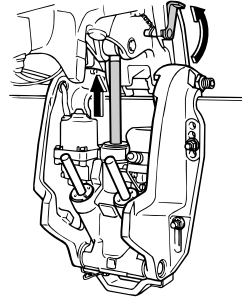

ZMU02635

7. Activate the trim-up switch until the tilt rod is fully extended. Unlock the tilt support lever.
8. Tilt the outboard motor down. Check that the tilt rod and trim rods operate smoothly.

NOTE: _____
Consult your Yamaha dealer if any operation is abnormal.

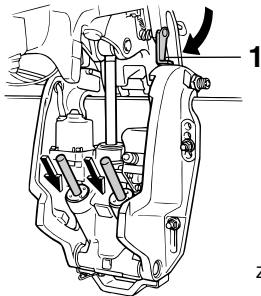

ZMU02634

1. Tilt support lever
5. Check that the tilt rod and trim rods are free of corrosion or other flaws.
 6. Activate the tilt-down switch until the trim rods have retracted completely into the cylinders.

EMU32110

Checking propeller

EWM01610

WARNING

You could be seriously injured if the engine accidentally starts when you are near the propeller.

- Before inspecting, removing, or installing the propeller, remove the spark plug caps from the spark plugs. Also, place the shift control in neutral, turn the main switch to "OFF" (off) and remove the key, and remove the cord from the engine shut-off switch. Turn off the battery cut-off switch if your boat has one.
- Do not use your hand to hold the propeller when loosening or tightening the propeller nut. Put a wood block between the anti-cavitation plate and the propeller to prevent the propeller from

Maintenance

turning.

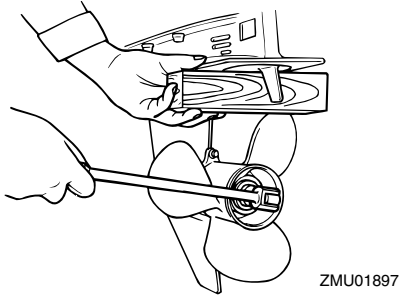
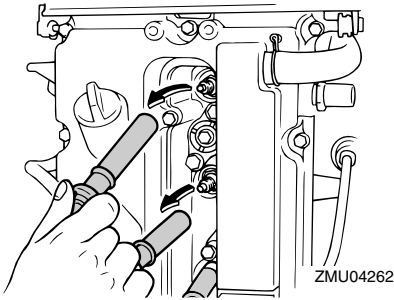

Checkpoints

- Check each of the propeller blades for wear, erosion from cavitation or ventilation, or other damage.
- Check the propeller shaft for damage.
- Check the splines for wear or damage.
- Check for fish line tangled around the propeller shaft.

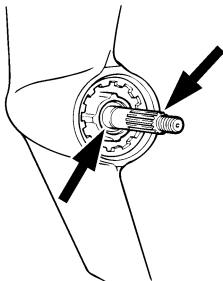

- Check the propeller shaft oil seal for dam-

age.

EMU30661

Removing propeller

EMU29195

Spline models

1. Straighten the cotter pin and pull it out using a pair of pliers.
2. Remove the propeller nut, washer, and spacer (if equipped).

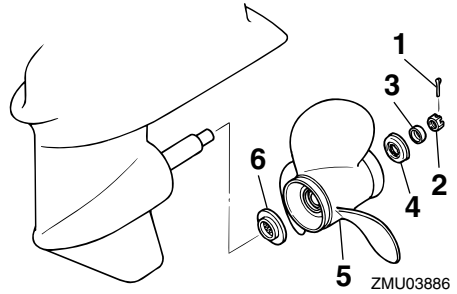

1. Cotter pin
2. Propeller nut
3. Washer
4. Spacer
5. Propeller
6. Thrust washer

3. Remove the propeller and thrust washer.

EMU30671

Installing propeller

EMU29242

Spline models

EWM00770



WARNING

On counter rotation models, be sure to use a propeller intended for counter-clockwise rotation. These propellers are identified with the letter "L" after the size indication on the propeller. Otherwise the boat could move in the opposite direction

from that expected.

ECM00340

CAUTION:

- Be sure to install the thrust washer before installing the propeller, otherwise the lower case and propeller boss could be damaged.
- Be sure to use a new cotter pin and bend the ends over securely. Otherwise the propeller could come off during operation and be lost.

1. Apply Yamaha marine grease or a corrosion resistant grease to the propeller shaft.
2. Install the thrust washer and propeller on the propeller shaft.
3. Install the spacer and washer. Tighten the propeller nut to the specified torque.

Propeller nut tightening torque:
55.0 Nm (40.6 ft-lb) (5.61 kgf-m)

4. Align the propeller nut with the propeller shaft hole. Insert a new cotter pin in the hole and bend the cotter pin ends.

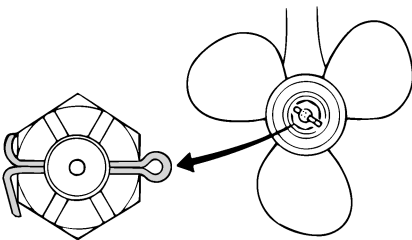

ZMU01805

NOTE:

If the propeller nut does not align with the propeller shaft hole after tightening to the specified torque, tighten the nut further to align it with the hole.

EMU29282

Changing gear oil

EWM00800

WARNING

- Be sure the outboard motor is securely fastened to the transom or a stable stand. You could be severely injured if the outboard motor falls on you.
- Never get under the lower unit while it is tilted, even when the tilt support lever or knob is locked. Severe injury could occur if the outboard motor accidentally falls.

1. Tilt the outboard motor so that the gear oil drain screw is at the lowest point possible.
2. Place a suitable container under the gear case.
3. Remove the gear oil drain screw and gasket.

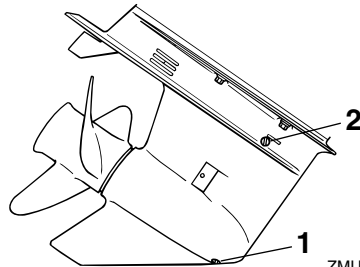

ZMU03273

1. Gear oil drain screw
2. Oil level plug

NOTE:

- If a magnetic gear oil drain screw is equipped, remove all metal particles from the screw before installing it.
- Always use new gaskets. Do not reuse the removed gaskets.

4. Remove the oil level plug and gasket to

Maintenance

allow the oil to drain completely.

ECM00710

CAUTION:

Inspect the used oil after it has been drained. If the oil is milky, water is getting into the gear case which can cause gear damage. Consult a Yamaha dealer for repair of the lower unit seals.

NOTE:

For disposal of used oil, consult your Yamaha dealer.

5. With the outboard motor in a vertical position, and using a flexible or pressurized filling device, inject the gear oil into the gear oil drain screw hole.

Recommended gear oil:

Hypoid gear oil SAE#90

Gear oil quantity:

F115AET 760.0 cm³ (25.70 US oz)
(26.81 Imp.oz)

FL115AET 715.0 cm³ (24.17 US oz)
(25.22 Imp.oz)

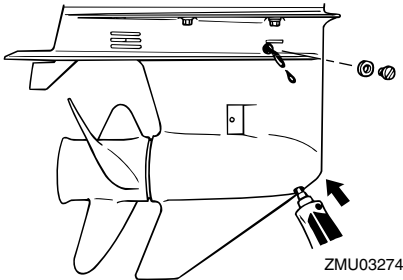

6. Put a new gasket on the oil level plug. When the oil begins to flow out of the oil level plug hole, insert and tighten the oil level plug.
7. Put a new gasket on the gear oil drain screw. Insert and tighten the gear oil

drain screw.

EMU29312

Inspecting and replacing anode(s)

Yamaha outboard motors are protected from corrosion by sacrificial anodes. Inspect the external anodes periodically. Remove scales from the surfaces of the anodes. Consult a Yamaha dealer for replacement of external anodes.

ECM00720

CAUTION:

Do not paint anodes, as this would render them ineffective.

NOTE:

Inspect ground leads attached to external anodes on equipped models. Consult a Yamaha dealer for inspection and replacement of internal anodes attached to the power unit.

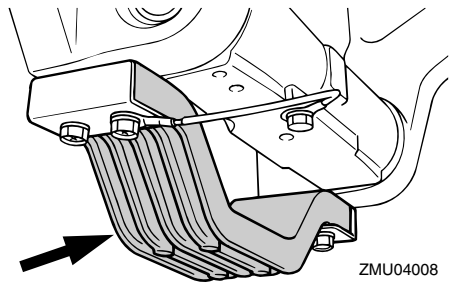
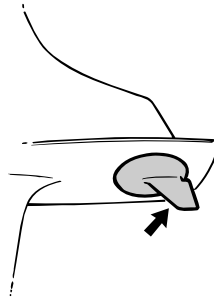

EMU29320

Checking battery (for electric start models)

EWM00330



Battery electrolytic fluid is dangerous; it contains sulfuric acid and therefore is poisonous and highly caustic.

Always follow these preventive measures:

- Avoid bodily contact with electrolytic fluid as it can cause severe burns or permanent eye injury.
- Wear protective eye gear when handling or working near batteries.

Antidote (EXTERNAL):

- SKIN - Flush with water.
- EYES - Flush with water for 15 minutes and get immediate medical attention.

Antidote (INTERNAL):

- Drink large quantities of water or milk followed by milk of magnesia, beaten egg, or vegetable oil. Get immediate medical attention.

Batteries also generate explosive hydrogen gas; therefore, you should always follow these preventive measures:

- Charge batteries in a well-ventilated area.
- Keep batteries away from fire, sparks, or open flames (for example: welding equipment, lighted cigarettes, and so on.)
- DO NOT SMOKE when charging or handling batteries.

KEEP BATTERIES AND ELECTROLYTIC FLUID OUT OF REACH OF CHILDREN.

ECM00360

CAUTION:

- A poorly maintained battery will quickly

deteriorate.

- Ordinary tap water contains minerals harmful to a battery, and should not be used for topping up.

1. Check the electrolyte level at least once a month. Fill to the manufacturer's recommended level when necessary. Top up only with distilled water (or pure de-ionized water suitable to use in batteries).

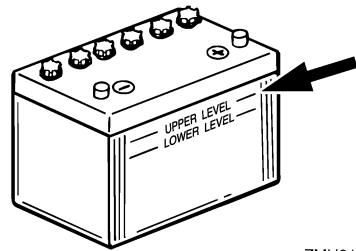

ZMU01810

2. Always keep the battery in a good state of charge. Installing a voltmeter will help you monitor your battery. If you will not use the boat for a month or more, remove the battery from the boat and store it in a cool, dark place. Completely recharge the battery before using it.
3. If the battery will be stored for longer than a month, check the specific gravity of the fluid at least once a month and recharge the battery when it is low.

NOTE:

Consult a Yamaha dealer when charging or re-charging batteries.

EMU29332

Connecting the battery

EWM00570



Mount the battery holder securely in a dry, well-ventilated, vibration-free loca-

Maintenance

tion in the boat. Install a fully charged battery in the holder.

ECM01122

CAUTION:

- Make sure the main switch (on applicable models) is “OFF” (off) before working on the battery.
- Reversal of the battery cables will damage the electrical parts.
- Connect the red battery cable first when installing the battery and disconnect the black battery cable first when removing it.
- The electrical contacts of the battery and cables must be clean and properly connected, or the battery will not start the engine.

Connect the red battery cable to the POSITIVE (+) terminal first. Then connect the black battery cable to the NEGATIVE (-) terminal.

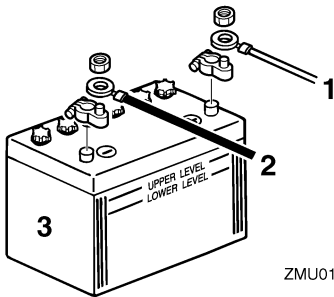

ZMU01811

1. Red cable
2. Black cable
3. Battery

EMU29370

Disconnecting the battery

Disconnect the BLACK cable from the NEGATIVE (-) terminal first. Then disconnect the RED cable from the POSITIVE (+) terminal.

EMU29391

Checking top cowling

ECM01650

CAUTION:

Be sure the cowling is closed securely and that there are no gaps. A loose or improperly fitting cover could allow water into the engine.

Check the fitting of the top cowling by pushing it with both hands. If it is loose have it repaired by your Yamaha dealer.

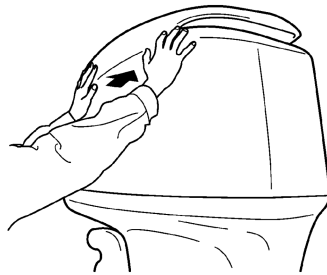

ZMU01812

EMU29400

Coating the boat bottom

A clean hull improves boat performance. The boat bottom should be kept as clean of marine growth as possible. If necessary, the boat bottom can be coated with an anti-fouling paint approved for your area to inhibit marine growth.

Do not use anti-fouling paint which includes copper or graphite. These paints can cause more rapid engine corrosion.

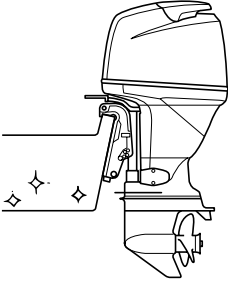

ZMU04246

Trouble Recovery

EMU29425

Troubleshooting

A problem in the fuel, compression, or ignition systems can cause poor starting, loss of power, or other problems. This section describes basic checks and possible remedies, and covers all Yamaha outboard motors. Therefore some items may not apply to your model.

If your outboard motor requires repair, bring it to your Yamaha dealer.

If the engine trouble-warning indicator is flashing, consult your Yamaha dealer.

Starter will not operate.

Q. Is battery capacity weak or low?

A. Check battery condition. Use battery of recommended capacity.

Q. Are battery connections loose or corroded?

A. Tighten battery cables and clean battery terminals.

Q. Is fuse for electric start relay or electric circuit blown?

A. Check for cause of electric overload and repair. Replace fuse with one of correct amperage.

Q. Are starter components faulty?

A. Have serviced by a Yamaha dealer.

Q. Is shift lever in gear?

A. Shift to neutral.

Engine will not start (starter operates).

Q. Is fuel tank empty?

A. Fill tank with clean, fresh fuel.

Q. Is fuel contaminated or stale?

A. Fill tank with clean, fresh fuel.

Q. Is fuel filter clogged?

A. Clean or replace filter.

Q. Is starting procedure incorrect?

A. See page 42.

Q. Has fuel pump malfunctioned?

A. Have serviced by a Yamaha dealer.

Q. Are spark plug(s) fouled or of incorrect type?

A. Inspect spark plug(s). Clean or replace with recommended type.

Q. Are spark plug cap(s) fitted incorrectly?

A. Check and re-fit cap(s).

Q. Is ignition wiring damaged or poorly connected?

A. Check wires for wear or breaks. Tighten all loose connections. Replace worn or broken wires.

Q. Are ignition parts faulty?

A. Have serviced by a Yamaha dealer.

Q. Is engine shut-off cord not attached?

A. Attach cord.

Q. Are engine inner parts damaged?

A. Have serviced by a Yamaha dealer.

Engine idles irregularly or stalls.

Q. Are spark plug(s) fouled or of incorrect type?

A. Inspect spark plug(s). Clean or replace with recommended type.

Q. Is fuel system obstructed?

A. Check for pinched or kinked fuel line or other obstructions in fuel system.

Q. Is fuel contaminated or stale?

A. Fill tank with clean, fresh fuel.

Q. Is fuel filter clogged?

A. Clean or replace filter.

Q. Have ignition parts failed?

A. Have serviced by a Yamaha dealer.

Q. Has warning system activated?

A. Find and correct cause of warning.

Q. Is spark plug gap incorrect?

A. Inspect and adjust as specified.

Q. Is ignition wiring damaged or poorly connected?

A. Check wires for wear or breaks. Tighten all loose connections. Replace worn or broken wires.

Q. Is specified engine oil not being used?

A. Check and replace oil as specified.

Q. Is thermostat faulty or clogged?

A. Have serviced by a Yamaha dealer.

Q. Are carburetor adjustments incorrect?

A. Have serviced by a Yamaha dealer.

Q. Is fuel pump damaged?

A. Have serviced by a Yamaha dealer.

Q. Is air vent screw on fuel tank closed?

A. Open air vent screw.

Q. Is choke knob pulled out?

A. Return to home position.

Q. Is motor angle too high?

A. Return to normal operating position.

Q. Is carburetor clogged?

A. Have serviced by a Yamaha dealer.

Q. Is fuel joint connection incorrect?

A. Connect correctly.

Q. Is throttle valve adjustment incorrect?

A. Have serviced by a Yamaha dealer.

Q. Is battery cable disconnected?

A. Connect securely.

Warning buzzer sounds or indicator lights.

Q. Is cooling system clogged?

A. Check water intake for restriction.

Q. Is engine oil level low?

A. Fill oil tank with specified engine oil.

Q. Is heat range of spark plug incorrect?

A. Inspect spark plug and replace it with recommended type.

Q. Is specified engine oil not being used?

A. Check and replace oil with specified type.

Q. Is engine oil contaminated or deteriorated?

A. Replace oil with fresh, specified type.

Q. Is oil filter clogged?

A. Have serviced by a Yamaha dealer.

Q. Has oil feed/injection pump malfunctioned?

A. Have serviced by a Yamaha dealer.

Trouble Recovery

Q. Is load on boat improperly distributed?

A. Distribute load to place boat on an even plane.

Q. Is water pump or thermostat faulty?

A. Have serviced by a Yamaha dealer.

Q. Is there excess water in fuel filter cup?

A. Drain filter cup.

Engine power loss.

Q. Is propeller damaged?

A. Have propeller repaired or replaced.

Q. Is propeller pitch or diameter incorrect?

A. Install correct propeller to operate out-board at its recommended speed (r/min) range.

Q. Is trim angle incorrect?

A. Adjust trim angle to achieve most efficient operation.

Q. Is motor mounted at incorrect height on transom?

A. Have motor adjusted to proper transom height.

Q. Has warning system activated?

A. Find and correct cause of warning.

Q. Is boat bottom fouled with marine growth?

A. Clean boat bottom.

Q. Are spark plug(s) fouled or of incorrect type?

A. Inspect spark plug(s). Clean or replace with recommended type.

Q. Are weeds or other foreign matter tangled

on gear housing?

A. Remove foreign matter and clean lower unit.

Q. Is fuel system obstructed?

A. Check for pinched or kinked fuel line or other obstructions in fuel system.

Q. Is fuel filter clogged?

A. Clean or replace filter.

Q. Is fuel contaminated or stale?

A. Fill tank with clean, fresh fuel.

Q. Is spark plug gap incorrect?

A. Inspect and adjust as specified.

Q. Is ignition wiring damaged or poorly connected?

A. Check wires for wear or breaks. Tighten all loose connections. Replace worn or broken wires.

Q. Have electrical parts failed?

A. Have serviced by a Yamaha dealer.

Q. Is specified fuel not being used?

A. Replace fuel with specified type.

Q. Is specified engine oil not being used?

A. Check and replace oil with specified type.

Q. Is thermostat faulty or clogged?

A. Have serviced by a Yamaha dealer.

Q. Is air vent screw closed?

A. Open the air vent screw.

Q. Is fuel pump damaged?

A. Have serviced by a Yamaha dealer.

Trouble Recovery

Q. Is fuel joint connection incorrect?

A. Connect correctly.

Q. Is heat range of spark plug incorrect?

A. Inspect spark plug and replace it with recommended type.

Q. Is high pressure fuel pump drive belt broken?

A. Have serviced by a Yamaha dealer.

Q. Is engine not responding properly to shift lever position?

A. Have serviced by a Yamaha dealer.

Engine vibrates excessively.

Q. Is propeller damaged?

A. Have propeller repaired or replaced.

Q. Is propeller shaft damaged?

A. Have serviced by a Yamaha dealer.

Q. Are weeds or other foreign matter tangled on propeller?

A. Remove and clean propeller.

Q. Is motor mounting bolt loose?

A. Tighten bolt.

Q. Is steering pivot loose or damaged?

A. Tighten or have serviced by a Yamaha dealer.

EMU29433

Temporary action in emergency

EMU29440

Impact damage

EWM00870



The outboard motor can be seriously damaged by a collision while operating or

trailing. Damage could make the outboard motor unsafe to operate.

If the outboard motor hits an object in the water, follow the procedure below.

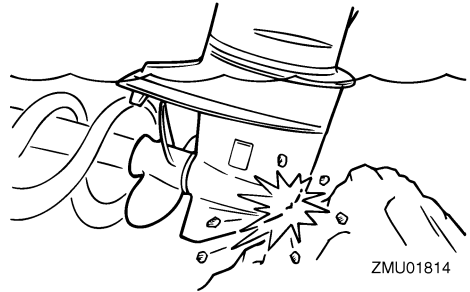

1. Stop the engine immediately.
2. Inspect the control system and all components for damage. Also inspect the boat for damage.
3. Whether damage is found or not, return to the nearest harbor slowly and carefully.
4. Have a Yamaha dealer inspect the outboard motor before operating it again.

EMU29451

Running single engine

When using only one engine in an emergency, be sure to keep the unused one tilted up and operate the other engine at low speed.

ECM00370

CAUTION:

If the boat is operated with one engine in the water but not running, water may run into the exhaust pipe due to wave action, causing engine trouble.

NOTE:

When you are maneuvering at low speed, such as near a dock, it is recommended that both engines be running with one in neutral gear if possible.

Trouble Recovery

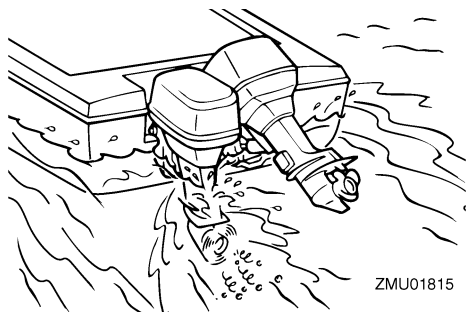

EMU29480

Replacing fuse

If the fuse has blown on an electric start model, remove the electrical cover, open the fuse holder, and replace the fuse with a new one of the proper amperage.

EWM00630



Be sure to use the specified fuse. An incorrect fuse or a piece of wire could allow excessive current flow. This could cause electric system damage and a fire hazard.

NOTE:

Consult your Yamaha dealer if the new fuse immediately blows again.

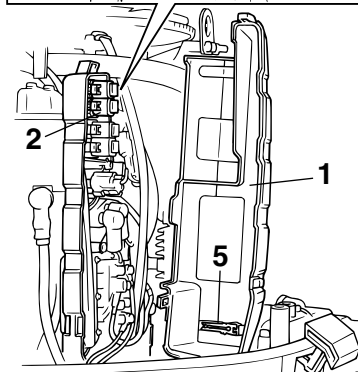
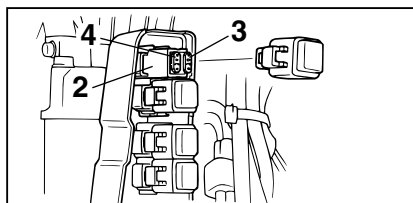

1. Electrical cover
2. Fuse holder
3. Fuse (20 A × 2, 30 A × 2)
4. Spare fuse (20 A, 30 A)
5. Fuse puller

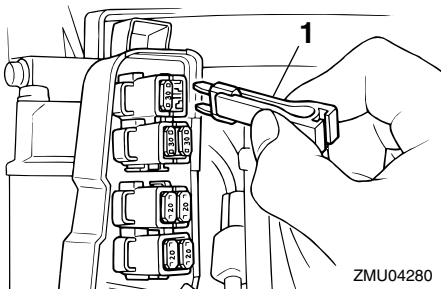

1. Fuse puller

EMU29523

Power trim and tilt will not operate

If the engine cannot be tilted up or down with the power trim and tilt because of a dis-

Trouble Recovery

charged battery or a failure with the power trim and tilt unit, the engine can be tilted manually.

1. Loosen the manual valve screw by turning it counterclockwise until it stops.

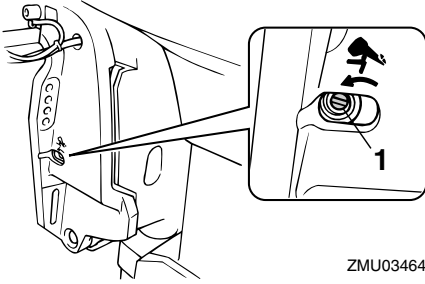

ZMU03464

1. Manual valve screw
2. Put the engine in the desired position, then tighten the manual valve screw by turning it clockwise.

EMU31781

Water separator-warning indicator blinks while cruising

EWM01500

WARNING

Gasoline is highly flammable, and its vapors are flammable and explosive.

- Do not perform this procedure on a hot or running engine. Allow the engine to cool.
- There will be fuel in the fuel filter. Keep away from sparks, cigarettes, flames or other sources of ignition.
- This procedure will allow some fuel to spill. Catch fuel in a rag. Wipe up any spilled fuel immediately.
- The fuel filter must be reassembled carefully with the O-ring, filter cup, and hoses in place. Improper assembly or replacement could result in a fuel leak, which could result in a fire or explosion

hazard.

If the water separator-warning indicator on the Command Link tachometer blinks, perform the following procedure.

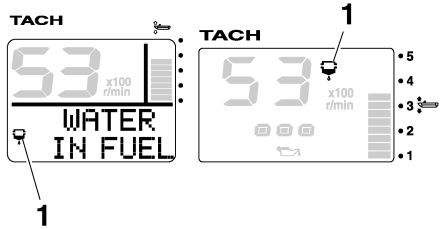

ZMU05442

1. Water separator-warning indicator
1. Stop the engine.
2. Remove the top cowling.
3. Disconnect the water detection switch coupler.

ECM01570

CAUTION:

Be careful not to get any water on the water detection switch coupler, otherwise a malfunction could occur.

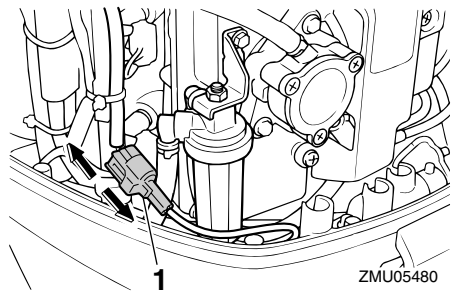

ZMU05480

1. Water detection switch coupler
4. Unscrew the filter cup from the filter housing.

Trouble Recovery

NOTE:

Be careful not to twist the water detection switch lead when unscrewing the filter cup.

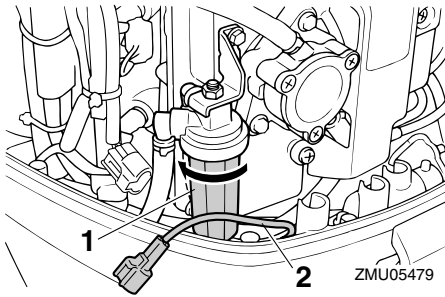

1. Filter cup
2. Water detection switch lead

5. Drain the water in the filter cup by soaking it up with a rag.

NOTE:

Properly dispose of the rag.

6. Firmly screw the filter cup onto the filter housing.

NOTE:

Be careful not to twist the water detection switch lead when screwing the filter cup onto the filter housing.

7. Connect the water detection switch coupler securely until a click is heard.

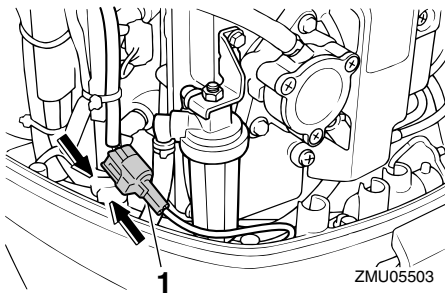

1. Water detection switch coupler

8. Install the top cowling.
9. Start the engine and make sure that the water separator-warning indicator remains off.

NOTE:

Have a Yamaha dealer inspect the outboard motor after returning to port.

EMU29542

Starter will not operate

If the starter mechanism does not operate (the engine cannot be cranked with the starter), the engine can be started manually with an emergency starter rope. However, the engine cannot be started manually if the battery voltage is low. If the battery is discharged to 9 volts or below, the electric fuel pump will not operate.

EWM01022

WARNING

- Use this procedure only in an emergency to return to the nearest port for repairs.
- When the emergency starter rope is used to start the engine, the start-in-gear protection device does not operate. Make sure the remote control lever is in neutral. Otherwise the boat could unexpectedly start to move, which could result in an accident.
- Attach the engine shut-off cord to a secure place on your clothing, or your arm or leg while operating the boat.
- Do not attach the cord to clothing that could tear loose. Do not route the cord where it could become entangled, preventing it from functioning.
- Avoid accidentally pulling the cord during normal operation. Loss of engine power means the loss of most steering control. Also, without engine power, the boat could slow rapidly. This could

Trouble Recovery

cause people and objects in the boat to be thrown forward.

- Make sure no one is standing behind you when pulling the starter rope. It could whip behind you and injure someone.
- An unguarded, rotating flywheel is very dangerous. Keep loose clothing and other objects away when starting the engine. Use the emergency starter rope only as instructed. Do not touch the flywheel or other moving parts when the engine is running. Do not install the starter mechanism or top cowling after the engine is running.
- Do not touch the ignition coil, spark plug wire, spark plug cap, or other electrical components when starting or operating the motor. You could get an electrical shock.

EMU29644

Emergency starting engine

1. Remove the top cowling.
2. Remove the two bolts holding the flywheel cover.
3. Lift up the rear of flywheel cover and pull it forward to remove it.

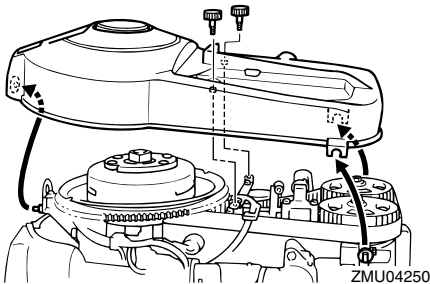

4. Prepare the engine for starting. For further information, see page 42. Be sure the engine is in neutral and that the clip is attached to the engine shut-off switch.

The main switch must be "ON" (on).

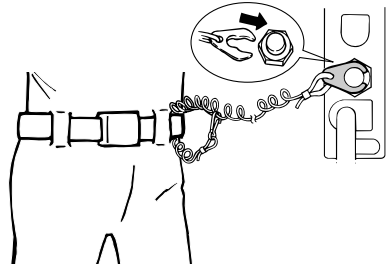

ZMU02334

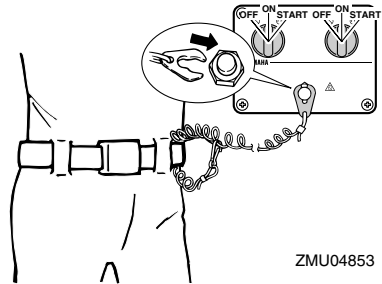

ZMU04853

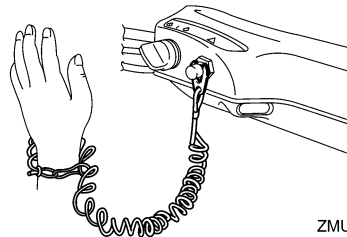

ZMU05216

5. Insert the knotted end of the emergency starter rope into the notch in the flywheel rotor and wind the rope around the flywheel clockwise.
6. Pull the rope slowly until resistance is felt.
7. Remove the rope from the flywheel temporarily.
8. Rewind the rope around the flywheel approximately 3/4 of a turn clockwise.

Trouble Recovery

9. Give a strong pull straight out to crank and start the engine. Repeat if necessary.

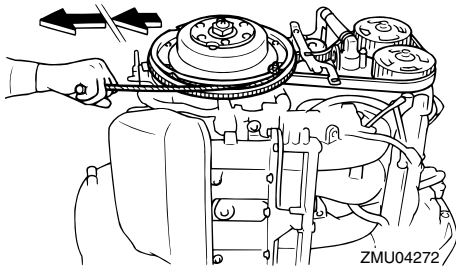

EMU33500

Treatment of submerged motor

If the outboard motor is submerged, immediately take it to a Yamaha dealer. Otherwise some corrosion may begin almost immediately.

ECM00400

CAUTION:

Do not attempt to run the outboard motor until it has been completely inspected.



YAMAHA MOTOR CO., LTD.

Printed in Japan

April 2007-0.4 × 2 

Printed on recycled paper