

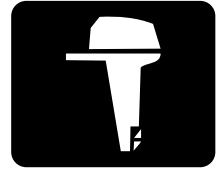

**YAMAHA**



**F115A  
FL115A**

**OWNER'S MANUAL**

**68V-28199-75-E0**

EMU25050

**Read this owner's manual carefully before operating your outboard motor.**

# Important manual information

EMU25100

## To the owner

Thank you for choosing a Yamaha outboard motor. This Owner's Manual contains information needed for proper operation, maintenance and care. A thorough understanding of these simple instructions will help you obtain maximum enjoyment from your new Yamaha. If you have any question about the operation or maintenance of your outboard motor, please consult a Yamaha dealer.

In this Owner's Manual particularly important information is distinguished in the following ways.



The Safety Alert Symbol means **ATTENTION! BECOME ALERT! YOUR SAFETY IS INVOLVED!**

EWM00780



### **WARNING**

**Failure to follow WARNING instructions could result in severe injury or death to the machine operator, a bystander, or a person inspecting or repairing the outboard motor.**

ECM00700

### **CAUTION:**

**A CAUTION indicates special precautions that must be taken to avoid damage to the outboard motor.**

### **NOTE:**

A NOTE provides key information to make procedures easier or clearer.

Yamaha continually seeks advancements in product design and quality. Therefore, while this manual contains the most current product information available at the time of printing, there may be minor discrepancies between your machine and this manual. If there is any question concerning this manu-

al, please consult your Yamaha dealer.

### **NOTE:**

The F115AET, FL115AET and the standard accessories are used as a base for the explanations and illustrations in this manual. Therefore some items may not apply to every model.

EMU25120

**F115A, FL115A  
OWNER'S MANUAL  
©2004 by Yamaha Motor Co., Ltd.  
1st Edition, March 2004  
All rights reserved.  
Any reprinting or unauthorized use  
without the written permission of  
Yamaha Motor Co., Ltd.  
is expressly prohibited.  
Printed in Japan**

# Table of contents

---

<b>General information .....</b>	<b>1</b>	Trip meter .....	15
Identification numbers record .....	1	Clock .....	16
Outboard motor serial number .....	1	Fuel gauge .....	16
Key number.....	1	Fuel warning indicator .....	16
EC label.....	1	Low battery voltage warning indicator .....	17
Safety information .....	2	Fuel management meter .....	17
Important labels.....	3	Fuel flow meter.....	17
Warning labels .....	3	Fuel consumption meter.....	18
Fueling instructions .....	3	Fuel economy.....	18
Gasoline.....	4	Twin-engine speed synchronizer ....	19
Engine oil .....	4	Warning system .....	19
Battery requirement.....	4	Overheat warning (twin engines) ....	20
Battery specifications .....	4	Low oil pressure warning .....	20
Propeller selection.....	4	Engine trouble warning .....	21
Start-in-gear protection .....	5	<b>Operation .....</b>	<b>22</b>
<b>Basic components .....</b>	<b>6</b>	Installation.....	22
Main components.....	6	Mounting the outboard motor .....	22
Remote control.....	6	Breaking in engine .....	23
Remote control lever.....	7	Procedure for 4-stroke models.....	23
Neutral interlock trigger.....	7	Preoperation checks .....	23
Neutral throttle lever.....	8	Fuel .....	24
Free accelerator.....	8	Controls.....	24
Throttle friction adjuster.....	8	Engine .....	24
Engine stop lanyard switch .....	9	Checking the engine oil level .....	24
Main switch .....	10	Filling fuel.....	25
Power trim and tilt switch on remote control or tiller handle .....	10	Operating engine .....	25
Power trim and tilt switch on bottom engine cowling.....	10	Feeding fuel .....	25
Power trim and tilt switches (twin binnacle type).....	11	Starting engine .....	25
Trim tab with anode .....	11	Warming up engine.....	27
Tilt support lever for power trim and tilt or hydro tilt model.....	12	Manual start and electric start models .....	27
Top cowling lock lever (pull up type) .....	12	Shifting.....	27
Flushing device .....	12	Forward (tiller handle and remote control models) .....	27
Digital tachometer .....	13	Reverse (automatic reverse lock and power trim and tilt models).....	28
Low oil pressure warning indicator..	13	Stopping engine .....	28
Overheat warning indicator (digital type) .....	13	Procedure.....	28
Speedometer (digital type) .....	14	Trimming outboard motor.....	29
Trim meter (digital type) .....	14	Adjusting trim angle.....	29
Hour meter (digital type).....	15	Adjusting boat trim .....	30
Engine trouble warning indicator.....	15	Tilting up and down.....	31
		Procedure for tilting up .....	32
		Procedure for tilting down .....	33

# Table of contents

Cruising in shallow water .....	34	<b>Trouble Recovery.....</b>	<b>56</b>
Power trim and tilt models / power tilt models.....	34	Troubleshooting .....	56
Cruising in other conditions.....	35	Temporary action in emergency ....	59
<b>Maintenance.....</b>	<b>36</b>	Impact damage .....	59
Specifications .....	36	Running single engine.....	59
Transporting and storing outboard motor.....	37	Replacing fuse .....	60
Storing outboard motor .....	37	Power trim and tilt will not operate ..	60
Procedure .....	38	Starter will not operate .....	61
Lubrication (except oil injection models) .....	39	Emergency starting engine .....	61
Battery care.....	39	<b>Treatment of submerged motor ....</b>	<b>62</b>
Flushing power unit.....	40	Procedure.....	63
Cleaning the outboard motor .....	41		
Checking painted surface of motor.....	41		
Periodic maintenance.....	41		
Replacement parts .....	41		
Maintenance chart .....	42		
Maintenance chart (additional).....	43		
Greasing .....	44		
Cleaning and adjusting spark plug ..	44		
Checking fuel system .....	45		
Inspecting fuel filter .....	46		
Cleaning fuel filter .....	46		
Inspecting idling speed .....	46		
Changing engine oil .....	47		
Checking wiring and connectors .....	49		
Exhaust leakage .....	49		
Water leakage .....	49		
Engine oil leakage.....	49		
Checking power trim and tilt system .....	49		
Checking propeller .....	50		
Removing the propeller.....	51		
Installing the propeller .....	51		
Changing gear oil .....	52		
Inspecting and replacing anode(s) ..	53		
Checking battery (for electric start models) .....	53		
Connecting the battery .....	54		
Disconnecting the battery .....	55		
Checking top cowling .....	55		
Coating the boat bottom.....	55		

# General information

EMU25170

## Identification numbers record

--	--	--

EMU25182

### Outboard motor serial number

The outboard motor serial number is stamped on the label attached to the port side of the clamp bracket or the upper part of the swivel bracket.

Record your outboard motor serial number in the spaces provided to assist you in ordering spare parts from your Yamaha dealer or for reference in case your outboard motor is stolen.

ZMU01693

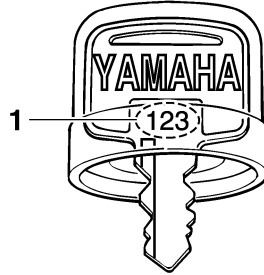

ZMU01694

1. Key number

EMU25202

### EC label

Engines affixed with this label conform to certain portions of the European Parliament directive relating to machinery. Refer to the label and the EC Declaration of Conformity for more details.

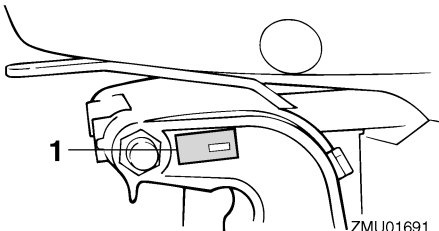

ZMU01691

1. Outboard motor serial number location

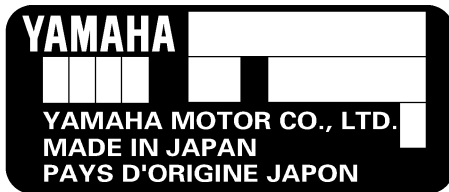

ZMU01692

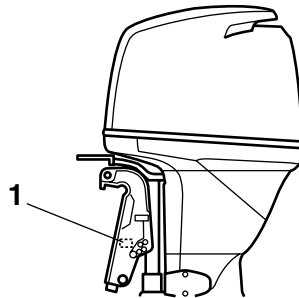

ZMU04273

1. EC label location

EMU25190

### Key number

If a main key switch is equipped with the motor, the key identification number is stamped on your key as shown in the illustration. Record this number in the space provided for reference in case you need a new key.

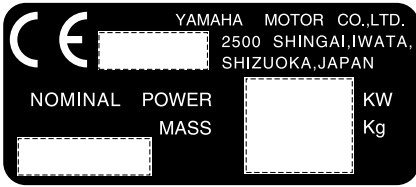

ZMU01696

EMU25370

## Safety information

- Before mounting or operating the outboard motor, read this entire manual. Reading it should give you an understanding of the motor and its operation.
  - Before operating the boat, read any owner's or operator's manuals supplied with it and all labels. Be sure you understand each item before operating.
  - Do not overpower the boat with this outboard motor. Overpowering the boat could result in loss of control. The rated power of the outboard should be equal to or less than the rated horsepower capacity of the boat. If the rated horsepower capacity of the boat is unknown, consult the dealer or boat manufacturer.
  - Do not modify the outboard. Modifications could make the motor unfit or unsafe to use.
  - Never operate after drinking alcohol or taking drugs. About 50% of all boating fatalities involve intoxication.
  - Have an approved personal flotation device (PFD) on board for every occupant. It is a good idea to wear a PFD whenever boating. At a minimum, children and non-swimmers should always wear PFDs, and everyone should wear PFDs when there are potentially hazardous boating conditions.
- Gasoline is highly flammable, and its vapors are flammable and explosive. Handle and store gasoline carefully. Make sure there are no gas fumes or leaking fuel before starting the engine.
  - This product emits exhaust gases which contain carbon monoxide, a colorless, odorless gas which may cause brain damage or death when inhaled. Symptoms include nausea, dizziness, and drowsiness. Keep cockpit and cabin areas well ventilated. Avoid blocking exhaust outlets.
  - Check throttle, shift, and steering for proper operation before starting the engine.
  - Attach the engine stop switch lanyard to a secure place on your clothing, or your arm or leg while operating. If you accidentally leave the helm, the lanyard will pull from the switch, stopping the engine.
  - Know the marine laws and regulations where you will be boating - and obey them.
  - Stay informed about the weather. Check weather forecasts before boating. Avoid boating in hazardous weather.
  - Tell someone where you are going: leave a Float Plan with a responsible person. Be sure to cancel the Float Plan when you return.
  - Use common sense and good judgment when boating. Know your abilities, and be sure you understand how your boat handles under the different boating conditions you may encounter. Operate within your limits, and the limits of your boat. Always operate at safe speeds, and keep a careful watch for obstacles and other traffic.
  - Always watch carefully for swimmers during the engine operation.
  - Stay away from swimming areas.

# General information

---

- When a swimmer is in the water near you shift into neutral and shut off the engine.

EMU25380

## Important labels

EMU25395

### Warning labels

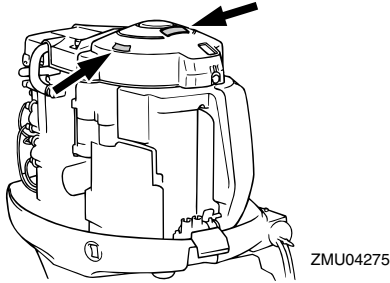

EMU25401

### Label

EWM01260

#### **WARNING**

- Be sure shift control is in neutral before starting engine. (except 2HP)
- Do not touch or remove electrical parts when starting or during operation.
- Keep hands, hair, and clothes away from flywheel and other rotating parts while engine is running.

EMU25413

### Label (counter rotation models)

EWM01281

#### **WARNING**

Use only a counterclockwise rotation propeller with this engine. Counterclockwise propellers are marked with a letter “L” after the size indication. The wrong type of propeller could cause the boat to go in an unexpected direction, which could lead to an accident.

---

EMU25540

## Fueling instructions

EWM00010

#### **WARNING**

**GASOLINE AND ITS VAPORS ARE HIGHLY FLAMMABLE AND EXPLOSIVE!**

- Do not smoke when refueling, and keep away from sparks, flames, or other sources of ignition.
- Stop engine before refueling.
- Refuel in a well-ventilated area. Refuel portable fuel tanks off the boat.
- Take care not to spill gasoline. If gasoline spills, wipe it up immediately with dry rags.
- Do not overfill the fuel tank.
- Tighten the filler cap securely after refueling.
- If you should swallow some gasoline, inhale a lot of gasoline vapor, or get gasoline in your eyes, get immediate medical attention.
- If any gasoline spills onto your skin, immediately wash with soap and water. Change clothing if gasoline spills on it.
- Touch the fuel nozzle to the filler opening or funnel to help prevent electrostatic sparks.

ECM00010

#### **CAUTION:**

Use only new clean gasoline which has been stored in clean containers and is not contaminated with water or foreign matter.

---



# General information

EMU25580

## Gasoline

Recommended gasoline:

Regular unleaded gasoline with a minimum octane rating of 90 (Research Octane Number).

If knocking or pinging occurs, use a different brand of gasoline or premium unleaded fuel.

EMU25680

## Engine oil

Recommended engine oil:

4-stroke motor oil with a combination of corresponding SAE and API as shown in the chart

Engine oil quantity (excluding oil filter):  
4.3 L (4.55 US qt) (3.78 Imp.qt)

SAE				API
-4	32	68	104 °F	SE
-20	0	20	40 °C	SF
10W-30				SG
10W-40				SH
				SJ

ZMU01709

ECM01050

### CAUTION:

**All 4-stroke engines are shipped from the factory without engine oil.**



ZMU01710

EMU25700

## Battery requirement

ECM01060

### CAUTION:

**Do not use a battery that does not meet the specified capacity. If a battery which does not meet specifications is used, the electric system could perform poorly or be overloaded, causing electric system damage.**

For electric start models, choose a battery which meets the following specifications.

EMU25720

## Battery specifications

Minimum cold cranking amps (CCA/EN):  
430.0 A  
Minimum rated capacity (20HR/IEC):  
70.0 Ah

### NOTE:

The engine cannot be started if battery voltage is too low.

EMU25741

## Propeller selection

The performance of your outboard motor will be critically affected by your choice of propeller, as an incorrect choice could adversely affect performance and could also seriously damage the motor. Engine speed depends on the propeller size and boat load. If engine

# General information

speed is too high or too low for good engine performance, this will have an adverse effect on the engine.

Yamaha outboard motors are fitted with propellers chosen to perform well over a range of applications, but there may be uses where a propeller with a different pitch would be more appropriate. For a greater operating load, a smaller-pitch propeller is more suitable as it enables the correct engine speed to be maintained. Conversely, a larger-pitch propeller is more suitable for a smaller operating load.

Yamaha dealers stock a range of propellers, and can advise you and install a propeller on your outboard that is best suited to your application.

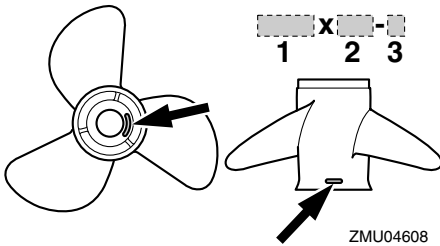

1. Propeller diameter in inches
2. Propeller pitch in inches
3. Type of propeller (propeller mark)

## NOTE:

Select a propeller which will allow the engine to reach the middle or upper half of the operating range at full throttle with the maximum boat load. If operating conditions such as light boat loads then allow the engine r/min to rise above the maximum recommended range, reduce the throttle setting to maintain the engine in the proper operating range.

For instructions on propeller removal and installation, see page 50.

EMU25760

## Start-in-gear protection

Yamaha outboard motors affixed with the pictured label or Yamaha-approved remote control units are equipped with start-in-gear protection device(s). This feature permits the engine to be started only when it is in neutral. Always select neutral before starting the engine.

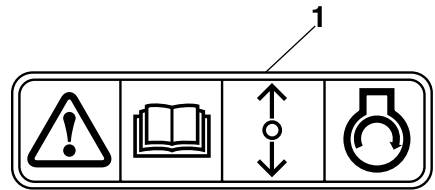

ZMU01713

1. Start-in-gear protection label

# Basic components

EMU25795

## Main components

### NOTE:

\* May not be exactly as shown; also may not be included as standard equipment on all models.

### F115A, FL115A

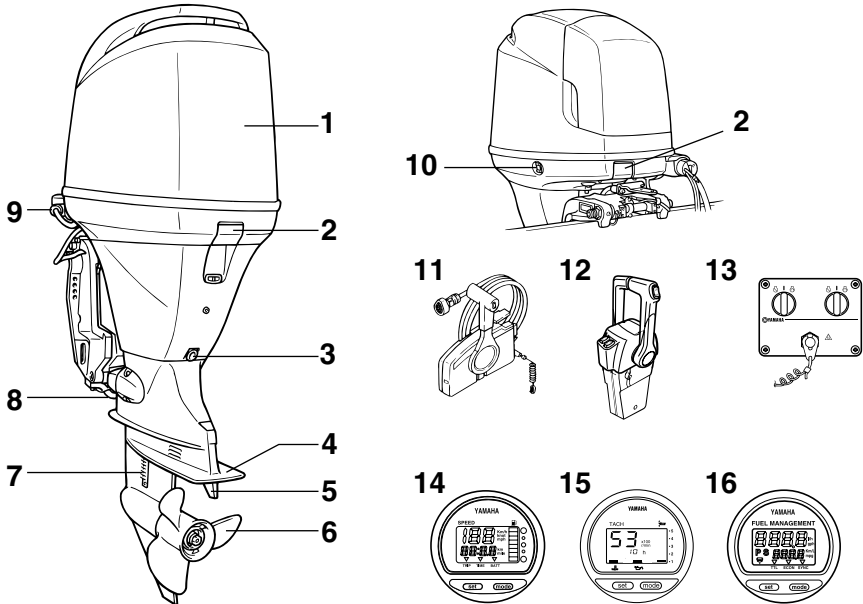

ZMU04775

1. Top cowling
2. Top cowling lock lever(s)
3. Drain screw
4. Anti-cavitation plate
5. Trim tab (anode)
6. Propeller\*
7. Cooling water inlet
8. Anode
9. Flushing device
10. Power trim and tilt switch
11. Remote control box (side mount type)\*
12. Remote control box (binnacle mount type)\*
13. Switch panel (for use with binnacle type)\*
14. Digital speedometer

15. Digital tachometer
16. Fuel management meter\*

EMU26180

### Remote control

The remote control lever actuates both the shifter and the throttle. The electrical switches are mounted on the remote control box.

# Basic components

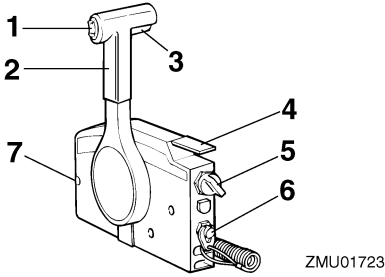

ZMU01723

1. Power trim and tilt switch
2. Remote control lever
3. Neutral interlock trigger
4. Neutral throttle lever
5. Main switch / choke switch
6. Engine stop lanyard switch
7. Throttle friction adjuster

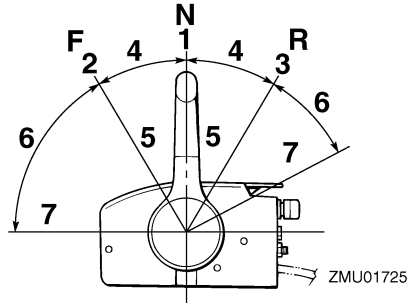

ZMU01725

1. Neutral "N"
2. Forward "F"
3. Reverse "R"
4. Shift
5. Fully closed
6. Throttle
7. Fully open

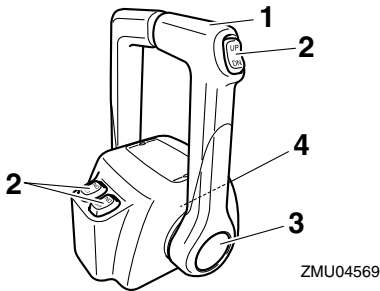

ZMU04569

1. Remote control lever
2. Power trim and tilt switch
3. Free accelerator
4. Throttle friction adjuster

EMU26190

## Remote control lever

Moving the lever forward from the neutral position engages forward gear. Pulling the lever back from neutral engages reverse. The engine will continue to run at idle until the lever is moved about 35° (a detent can be felt). Moving the lever farther opens the throttle, and the engine will begin to accelerate.

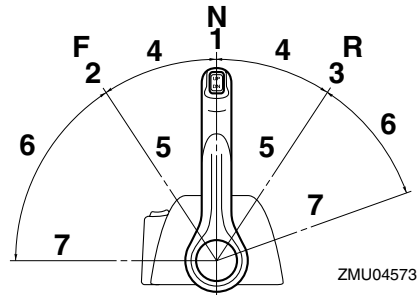

ZMU04573

1. Neutral "N"
2. Forward "F"
3. Reverse "R"
4. Shift
5. Fully closed
6. Throttle
7. Fully open

EMU26201

## Neutral interlock trigger

To shift out of neutral, first pull the neutral interlock trigger up.

# Basic components

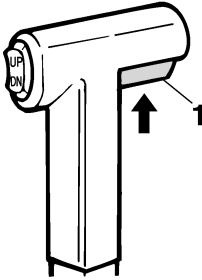

ZMU01727

1. Neutral interlock trigger

EMU26211

## Neutral throttle lever

To open the throttle without shifting into either forward or reverse, put the remote control lever in the neutral position and lift the neutral throttle lever.

### NOTE:

The neutral throttle lever will operate only when the remote control lever is in neutral. The remote control lever will operate only when the neutral throttle lever is in the closed position.

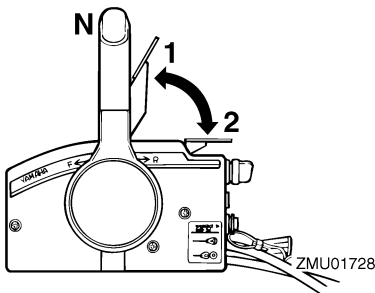

1. Fully open
2. Fully closed

EMU26230

## Free accelerator

To open the throttle without shifting into either forward or reverse, push the free accel-

erator button and move the remote control lever.

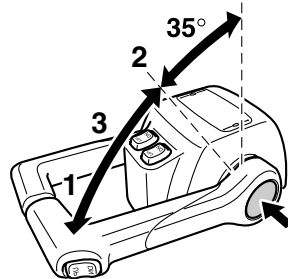

ZMU04575

1. Fully open
2. Fully closed
3. Free accelerator

### NOTE:

- The free accelerator button can only be used when the remote control lever is in the neutral position.
- After the button is pushed, the throttle begins to open after the remote control lever is moved at least 35°.
- After using the free accelerator, return the remote control lever to the neutral position. The free accelerator button will return automatically to its set position. The remote control will then engage forward and reverse normally.

EMU25970

## Throttle friction adjuster

A friction device provides adjustable resistance to movement of the throttle grip or the remote control lever, and can be set according to operator preference.

To increase resistance, turn the adjuster clockwise. To decrease resistance, turn the adjuster counterclockwise.

EWM00030

### **WARNING**

**Do not overtighten the friction adjuster. If**

# Basic components

there is too much resistance, it could be difficult to move throttle lever or grip, which could result in an accident.

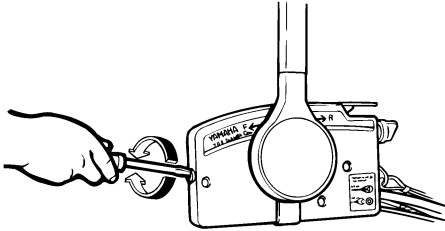

ZMU01714

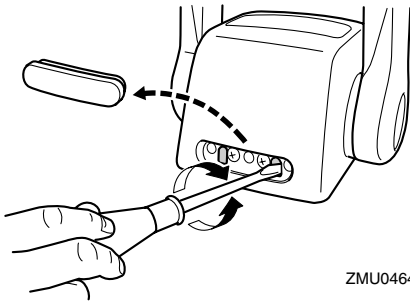

ZMU04646

When constant speed is desired, tighten the adjuster to maintain the desired throttle setting.

EMU25990

## Engine stop lanyard switch

The lock plate must be attached to the engine stop switch for the engine to run. The lanyard should be attached to a secure place on the operator's clothing, or arm or leg. Should the operator fall overboard or leave the helm, the lanyard will pull out the lock plate, stopping ignition to the engine. This will prevent the boat from running away under power.

EWMM00120



**WARNING**

- Attach the engine stop switch lanyard

to a secure place on your clothing, or your arm or leg while operating.

- Do not attach the lanyard to clothing that could tear loose. Do not route the lanyard where it could become entangled, preventing it from functioning.
- Avoid accidentally pulling the lanyard during normal operation. Loss of engine power means the loss of most steering control. Also, without engine power, the boat could slow rapidly. This could cause people and objects in the boat to be thrown forward.

## NOTE:

The engine cannot be started with the lock plate removed.

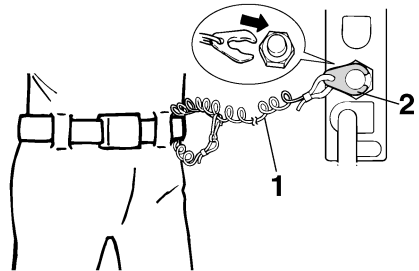

ZMU01716

1. Lanyard
2. Lock plate

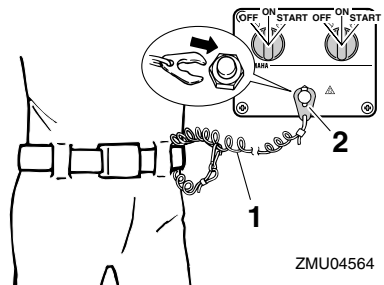

ZMU04564

1. Lanyard

# Basic components

## 2. Lock plate

EMU26090

### Main switch

The main switch controls the ignition system; its operation is described below.

- “OFF” (off)

With the main switch in the “OFF” (off) position, the electrical circuits are off, and the key can be removed.

- “ON” (on)

With the main switch in the “ON” (on) position, the electrical circuits are on, and the key cannot be removed.

- “START” (start)

With the main switch in the “START” (start) position, the starter motor turns to start the engine. When the key is released, it returns automatically to the “ON” (on) position.

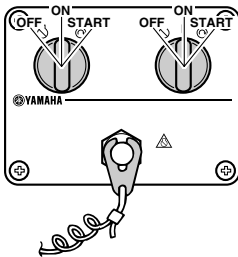
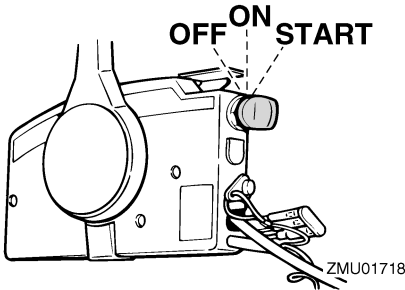

EMU26141

### Power trim and tilt switch on remote control or tiller handle

The power trim and tilt system adjusts the outboard motor angle in relation to the transom. Pressing the switch “UP” (up) trims the outboard motor up, then tilts it up. Pressing the switch “DN” (down) tilts the outboard motor down and trims it down. When the switch is released, the outboard motor will stop in its current position.

**NOTE:** \_\_\_\_\_

For instructions on using the power trim and tilt switch, see pages 29 and 31.

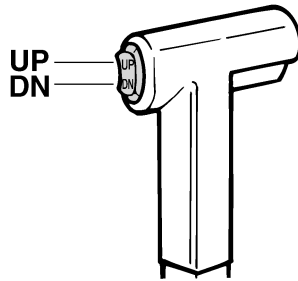

EMU26151

### Power trim and tilt switch on bottom engine cowling

The power trim and tilt switch is located on the side of the bottom engine cowling. Pressing the switch “UP” (up) trims the outboard motor up, then tilts it up. Pressing the switch “DN” (down) tilts the outboard motor down and trims it down. When the switch is released, the outboard motor will stop in its current position.

EWM01030

**WARNING** \_\_\_\_\_

**Use the power trim and tilt switch located on the bottom engine cowling only when the boat is at a complete stop with the engine off. Attempting to use this switch**

# Basic components

while the boat is moving could increase the risk of falling overboard and could distract the operator, increasing the risk of collision with another boat or an obstacle.

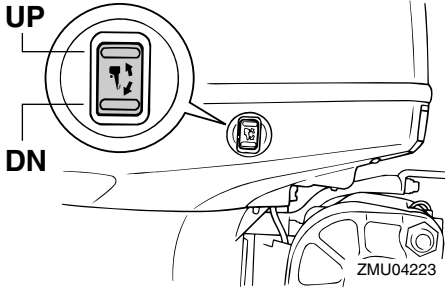

**NOTE:**  
For instructions on using the power trim and tilt switch, see page 31.

EMU26161

## Power trim and tilt switches (twin binnacle type)

The power trim and tilt system adjusts the outboard motor angle in relation to the transom. Pushing the switch “UP” (up) trims the outboard motor up, then tilts it up. Pressing the switch “DN” (down) tilts the outboard motor down and trims it down. When the switch is released, the outboard motor will stop in its current position.

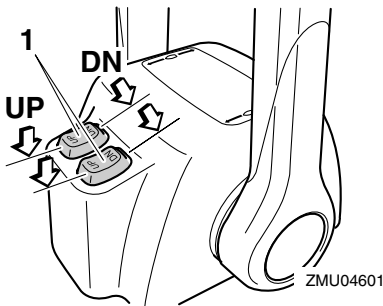

1. Power trim and tilt switch

**NOTE:**

- On the dual engine control, the switch on the remote control grip controls both outboard motors at the same time.
- For instructions on using the power trim and tilt switches, see pages 29 and 31.

EMU26240

## Trim tab with anode

The trim tab should be adjusted so that the steering control can be turned to either the right or left by applying the same amount of force.

EWM00840

## **WARNING**

**An improperly adjusted trim tab could cause difficult steering. Always test run after the trim tab has been installed or replaced to be sure steering is correct. Be sure you have tightened the bolt after adjusting the trim tab.**

If the boat tends to veer the left (port side), turn the trim tab rear end to the port side “A” in the figure. If the boat tends to veer the right (starboard side), turn the trim tab end to the starboard side “B” in the figure.

ECM00840

## **CAUTION:**

**The trim tab also serves as an anode to protect the engine from electrochemical corrosion. Never paint the trim tab as it will become ineffective as an anode.**



# Basic components

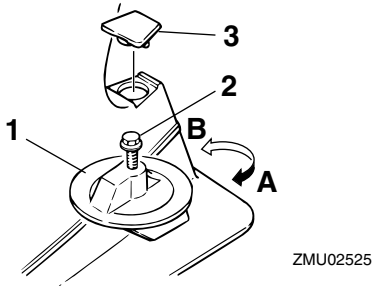

1. Trim tab
2. Bolt
3. Cap

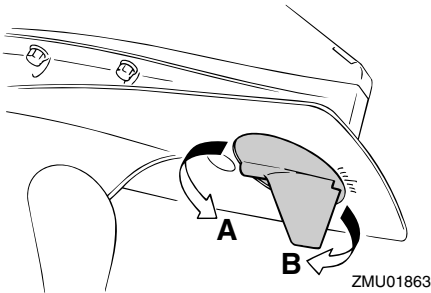

EMU26340

## Tilt support lever for power trim and tilt or hydro tilt model

To keep the outboard motor in the tilted up position, lock the tilt support lever to the clamp bracket.

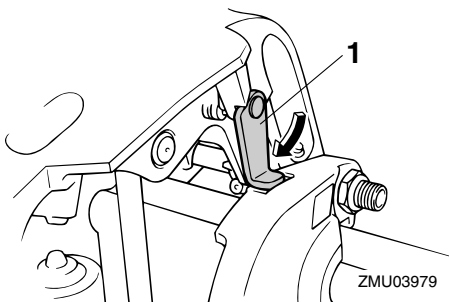

1. Tilt support lever

EMU26382

## Top cowling lock lever (pull up type)

To remove the engine top cowling, pull up the lock lever(s) and lift off the cowling. When installing the cowling, check to be sure it fits properly in the rubber seal. Then lock the cowling by moving the lever(s) downward.

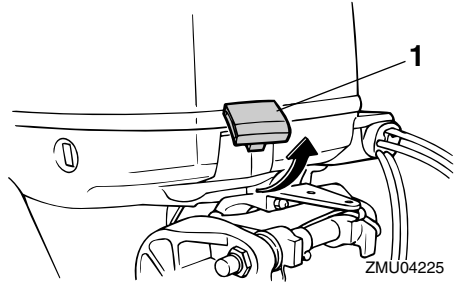

1. Top cowling lock lever(s)

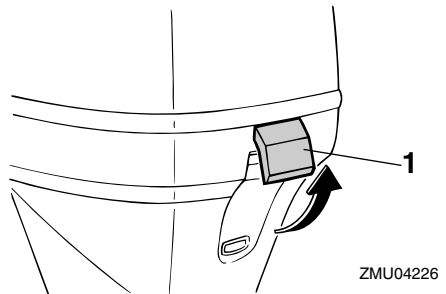

1. Top cowling lock lever(s)

EMU26460

## Flushing device

This device is used to clean the cooling water passages of the motor using a garden hose and tap water.

### NOTE:

For details on usage, see page 40.

# Basic components

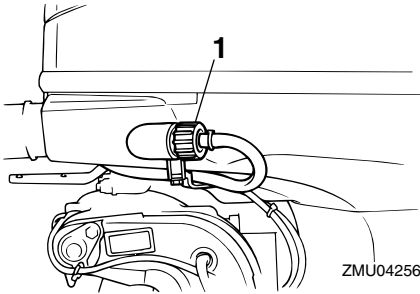

1. Flushing device

EMU26491

## Digital tachometer

The tachometer shows the engine speed and has the following functions.

### NOTE:

All segments of the display will light momentarily after the main switch is turned on and will return to normal thereafter.

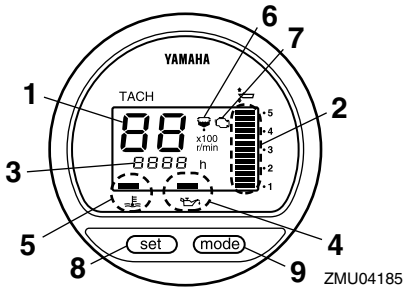

1. Tachometer
2. Trim meter
3. Hour meter
4. Low oil pressure warning indicator
5. Overheat warning indicator
6. Water separator warning indicator
7. Engine trouble warning indicator
8. Set button
9. Mode button

### NOTE:

The water separator and engine trouble warning indicators only operate when the engine is equipped with the appropriate functions.

EMU26521

## Low oil pressure warning indicator

If oil pressure drops too low, the warning indicator will start to blink. For further information, see page 20.

ECM00020

### CAUTION:

- Do not continue to run the engine if the low oil pressure warning indicator is on and the engine oil level is lower. Serious engine damage will occur.
- The low oil pressure warning indicator does not indicate the engine oil level. Use the oil dipstick to check the remaining oil quantity. For further information, see page 24.

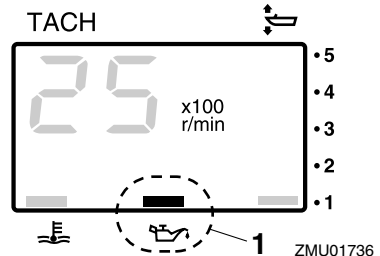

1. Low oil pressure warning indicator

EMU26581

## Overheat warning indicator (digital type)

If the engine temperature rises too high, the warning indicator will start to blink. For further information on reading the indicator, see

# Basic components

page 19.

ECM00050

## CAUTION:

**Do not continue to run the engine if the overheat warning indicator is on. Serious engine damage will occur.**

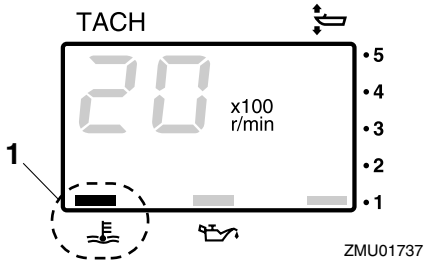

1. Overheat warning indicator

EMU26600

## Speedometer (digital type)

This gauge shows the boat speed.

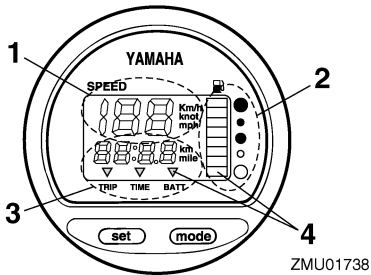

1. Speedometer
2. Fuel gauge
3. Trip meter/clock/voltmeter
4. Warning indicator(s)

## NOTE:

After the main switch is first turned on, all segments of the display come on as a test. After a few seconds, the gauge will change to normal operation. Watch the gauge when

turning on the main switch to make sure all segments come on.

## NOTE:

The speedometer displays km/h, mph, or knots, according to operator preference. Select the desired unit of measurement by setting the selector switch on the back of the gauge. See the illustration for settings.

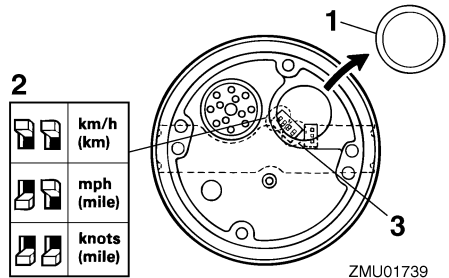

1. Cap
2. Selector switch (for speed unit)
3. Selector switch (for fuel sensor)

EMU26620

## Trim meter (digital type)

This meter shows the trim angle of your outboard motor.

## NOTE:

- Memorize the trim angles that work best for your boat under different conditions. Adjust the trim angle to the desired using the power trim and tilt switch.
- If the trim angle of your motor exceeds the trim operating range, the top segment on the trim meter display will blink.

# Basic components

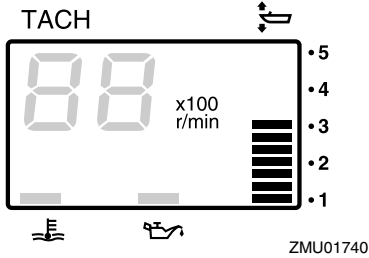

EMU26650

## Hour meter (digital type)

This meter shows the number of hours the engine has been run. It can be set to show the total number of hours or the number of hours for the current trip. The display can also be turned on and off.

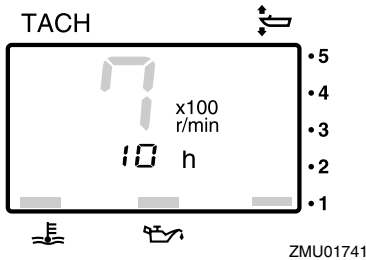

- Changing the display format
- Pressing the “mode” (mode) button changes the display format in the following pattern:
  - Total hours→Trip hours→Display off
  - Resetting the trip hours
  - Simultaneously pressing the “set” (set) and “mode” (mode) buttons for more than 1 second while the trip hours are displayed resets the trip counter to 0 (zero).

### NOTE:

The total number of hours the engine has been run cannot be reset.

EMU26680

## Engine trouble warning indicator

This indicator will blink when the engine malfunctions.

ECM00920

### CAUTION:

In such an event, the engine will not operate properly. Consult a Yamaha dealer immediately.

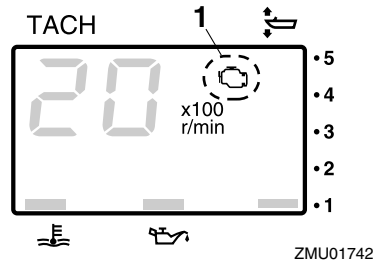

1. Engine trouble warning indicator

EMU26690

## Trip meter

This gauge displays the distance the boat has traveled since the gauge was last reset. Press the “mode” (mode) button repeatedly until the indicator on the face of the gauge points to “TRIP” (trip). To reset the trip meter to zero, press the “set” (set) and “mode” (mode) buttons at the same time.

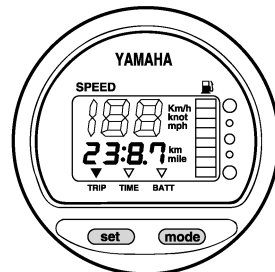

ZMU01743

# Basic components

## NOTE:

- The trip distance is shown in kilometers or miles depending upon the unit of measurement selected for the speedometer.
- The trip distance is kept in memory by battery power. The stored data will be lost if the battery is disconnected.

EMU26700

## Clock

Press the “mode” (mode) button repeatedly until the indicator on the face of the gauge points to “TIME” (time). To set the clock, be sure the gauge is in the “TIME” (time) mode. Press the “set” (set) button; the hour display will begin blinking. Press the “mode” (mode) button until the desired hour is displayed. Press the “set” (set) button again, the minute display will begin blinking. Press the “mode” (mode) button until the desired minute is displayed. Press the “set” (set) button again to start the clock.

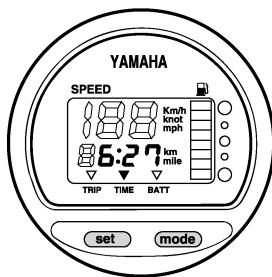

ZMU01744

## NOTE:

The clock operates on battery power. Disconnecting the battery will stop the clock. Reset the clock after connecting the battery.

EMU26710

## Fuel gauge

The fuel level is indicated by eight segments. When all segments are showing, the fuel

tank is full.

ECM00860

## CAUTION:

The Yamaha fuel tank sensor differs from conventional sensors. Incorrectly setting the selector switch on the gauge will give false readings. Consult your Yamaha dealer on how to correctly set the selector switch.

## NOTE:

The fuel level reading can be affected by the position of the sensor in the fuel tank and the attitude of the boat in the water. Operation with bow-up trim or continuous turning can give false readings.

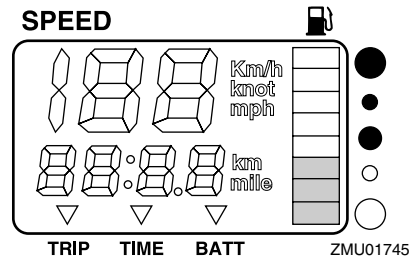

EMU26720

## Fuel warning indicator

If the fuel level decreases to one segment, the fuel level warning segment will begin to blink.

ECM00880

## CAUTION:

Do not continue to operate the engine with full throttle if a warning device has activated. Get back to the port within trolling engine speed.

# Basic components

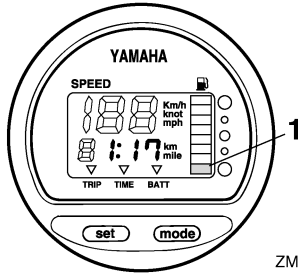

ZMU01746

1. Fuel level warning segment

EMU26730

## Low battery voltage warning indicator

If battery voltage drops, the display will automatically turn on and begin to blink.

ECM00870

### **CAUTION:**

**Get back to the port soon if a warning device has activated. For charging the battery, consult your Yamaha dealer.**

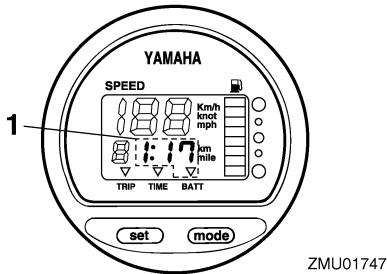

ZMU01747

1. Low battery indicator

EMU26740

## Fuel management meter

The fuel management meter shows the state of the fuel consumption while the engine is running.

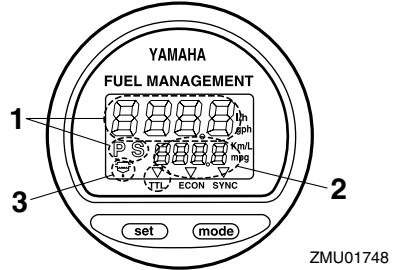

ZMU01748

1. Fuel flow meter
2. Fuel consumption meter / Fuel economy meter / Twin engine speed synchronizer
3. Water separator warning indicator (operates only if the sensor has been installed)

### **NOTE:**

After the main switch is first turned on, all segments of the display come on as a test. After a few seconds, the gauge will change to normal operation. Watch the gauge when turning on the main switch to make sure all segments come on.

EMU26750

## Fuel flow meter

The fuel flow meter displays the amount of fuel flow over a one hour period, at the current rate of engine operation.

If twin engines are installed on your boat, the fuel flow meter displays the total fuel flow of both the port and starboard engines. It also displays "P S" (for port and starboard).

# Basic components

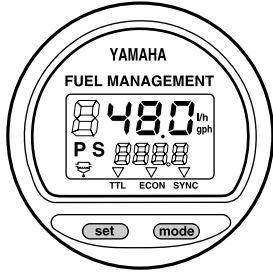

ZMU01749

Use the “set” (set) button to rotate the fuel flow display in the following order:

- Press the “set” (set) button once to display the fuel flow of the starboard engine. An “S” (for starboard) will also be displayed.
- Press the “set” (set) button a second time to display the fuel flow of the port engine. A “P” (for port) will also be displayed.
- Press the “set” (set) button a third time to return the display to the total fuel flow of both engines. “P S” (for port and starboard) will also be displayed to indicate both the port and starboard engines.

## NOTE:

- The fuel flow meter displays gallons/hour or liters/hour according to operator preference. Select the desired unit of measurement by setting the selector switch on the back of the gauge during installation.

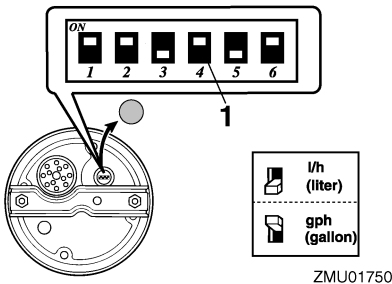

ZMU01750

1. Selector switch

- The fuel consumption meter and fuel economy meter will indicate the same unit of measurement.

EMU26760

## Fuel consumption meter

This gauge displays the total amount of fuel consumed since the gauge was last reset. Press the “mode” (mode) button repeatedly until the indicator on the face of the gauge points to total “TTL” (total). To reset the total fuel consumption to zero, press the “set” (set) and “mode” (mode) buttons at the same time.

## FUEL MANAGEMENT

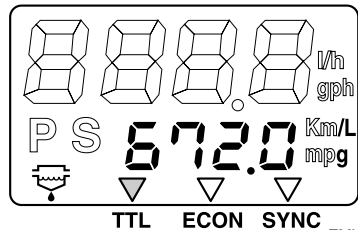

ZMU01751

EMU26770

## Fuel economy

This gauge displays the distance per liter or gallon when cruising, and is only for reference use by the operator.

Press the “mode” (mode) button repeatedly until the indicator on the face of the gauge points to “ECON” (economy).

## FUEL MANAGEMENT

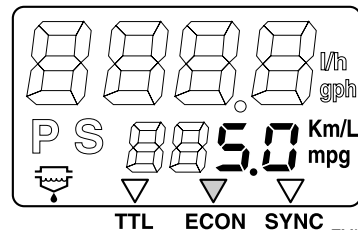

ZMU01752

# Basic components

**NOTE:** \_\_\_\_\_

If twin engines are installed on your boat, the gauge will only display the total fuel economy of both engines.

**NOTE:** \_\_\_\_\_

- Fuel consumption varies greatly with boat design, weight, propeller used, engine trim angle, sea conditions (including wind), and throttle position. Fuel consumption also varies slightly with the type of water (salt, fresh, and contaminate levels), air temperature and humidity, cleanliness of the boat bottom, engine mounting height, skill of the operator, and individual gasoline formulation (winter or summer fuel and amount of additives).
- The Yamaha digital speedometer and fuel management meter calculates speed, miles traveled, and fuel economy by water movement at the stern of the boat. This distance can vary greatly from the actual distance traveled because of water currents, sea swells, and the condition of the water speed sensor (partially plugged or damaged).
- Individual engines may slightly vary in their fuel consumption due to manufacturing variations. These variations can be even greater if the engines are of different year models. In addition, variations in propellers, even of the same basic dimensions of the same design, can also cause a slight variation in fuel consumption.

EMU26780

## Twin-engine speed synchronizer

This gauge displays the difference in engine speed (r/min) between the port and starboard engines for reference purposes when synchronizing the two engines' speeds. Press the "mode" (mode) button repeatedly

until the indicator on the face of the gauge points to "SYNC" (synchronizer).

## FUEL MANAGEMENT

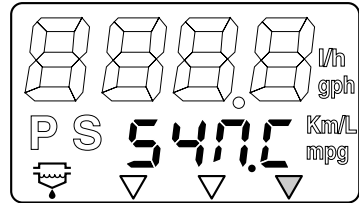

TTL ECON SYNC

ZMU01753

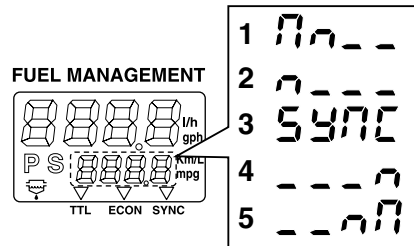

ZMU01754

1. Port engine speed is higher
2. Port engine speed is slightly higher
3. Engine speed is synchronized evenly between port and starboard engines
4. Starboard engine speed is slightly higher
5. Starboard engine speed is higher

**NOTE:** \_\_\_\_\_

If the two engines' speeds are not synchronized while cruising, they can be synchronized by adjusting trim angle or throttle.

EMU26801

## Warning system

ECM00090

**CAUTION:** \_\_\_\_\_

**Do not continue to operate the engine if a warning device has activated. Consult your Yamaha dealer if the problem can-**



not be located and corrected.

EMU30340

## Overheat warning (twin engines)

This engine has an overheat warning device. If the engine temperature rises too high, the warning device will activate.

Activation of warning device

- Engine speed will automatically decrease to 2000–3500 r/min.
- If equipped with an overheat warning indicator, it will light.

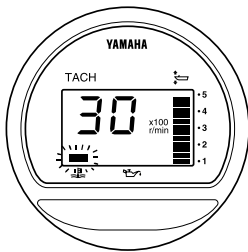

ZMU04227

- The buzzer will sound.

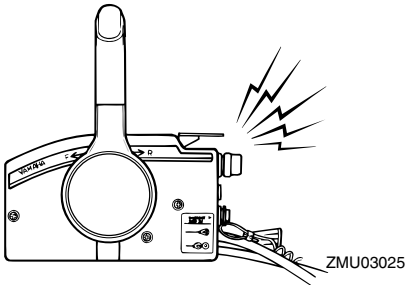

ZMU03025

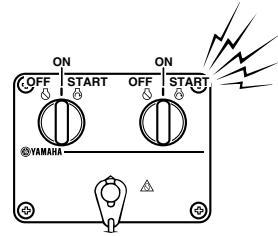

ZMU04584

If the warning system has activated, stop the engine and check the cooling water inlet for clogging.

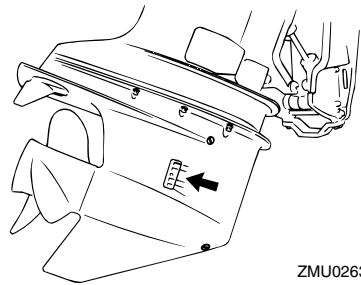

ZMU02630

## NOTE:

Dual engine drive users:

Should the overheat warning system of one engine activate, the engine will slow down and the buzzer will sound. This will cause the other engine to slow down and the buzzer to sound. To switch off the warning activation on the engine not affected by overheating, turn off the main switch of the engine overheating.

EMU30351

## Low oil pressure warning

If the oil pressure drops too low, the warning device will activate.

Activation of warning device

- Engine speed will automatically decrease to 2000–3500 r/min.

# Basic components

- The low oil pressure warning indicator will light.

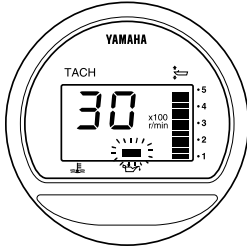

ZMU04254

- The buzzer will sound.

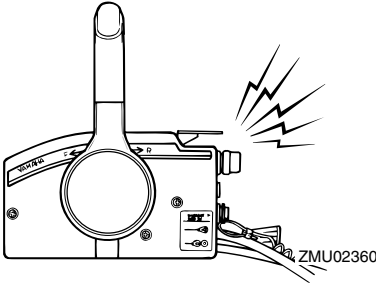

ZMU02360

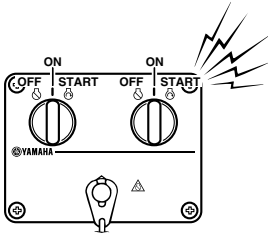

ZMU04584

If the warning system has activated, stop the engine as soon as it is safe to do so. Check the oil level and add oil as needed. If the oil level is correct, consult your Yamaha dealer.

ECM00100

## CAUTION:

**Do not continue to run the engine if the low oil pressure warning indicator is on.**

## Serious engine damage could occur.

EMU26880

### Engine trouble warning

When an engine malfunction is detected, the engine trouble warning indicator will blink. In such an event, the engine will not operate properly. Consult a Yamaha dealer immediately.

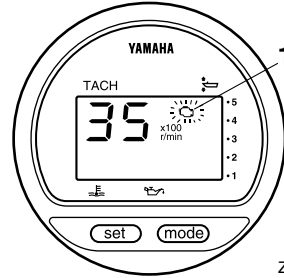

ZMU01759

1. Engine trouble warning indicator

EMU26901

## Installation

ECM00110

### CAUTION:

Incorrect engine height or obstructions to smooth water flow (such as the design or condition of the boat, or accessories such as transom ladders or depth finder transducers) can create airborne water spray while the boat is cruising. Severe engine damage may result if the motor is operated continuously in the presence of airborne water spray.

### NOTE:

During water testing check the buoyancy of the boat, at rest, with its maximum load. Check that the static water level on the exhaust housing is low enough to prevent water entry into the powerhead, when water rises due to waves when the outboard is not running.

EMU26910

## Mounting the outboard motor

EWM00820

### WARNING

- Overpowering a boat could cause severe instability. Do not install an outboard motor with more horsepower than the maximum rating on the capacity plate of the boat. If the boat does not have a capacity plate, consult the boat manufacturer.
- The information presented in this section is intended as reference only. It is not possible to provide complete instructions for every possible boat and motor combination. Proper mounting depends in part on experience and the

specific boat and motor combination.

EWM00830

### WARNING

Improper mounting of the outboard motor could result in hazardous conditions such as poor handling, loss of control, or fire hazards. Observe the following:

- For permanently mounted models, your dealer or other person experienced in proper rigging should mount the motor. If you are mounting the motor yourself, you should be trained by an experienced person.
- For portable models, your dealer or other person experienced in proper outboard motor mounting should show you how to mount your motor.

Mount the outboard motor on the center line (keel line) of the boat, and ensure that the boat itself is well balanced. Otherwise the boat will be hard to steer. For boats without a keel or which are asymmetrical, consult your dealer.

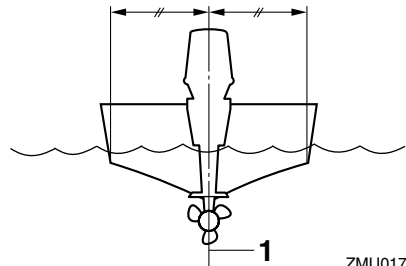

ZMU01760

1. Center line (keel line)

# Operation

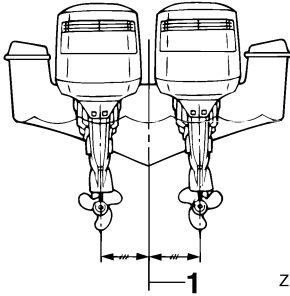

1. Center line (keel line)

EMU26930

## Mounting height (boat bottom)

To run your boat at optimum efficiency, the water resistance (drag) of the boat and outboard motor must be made as little as possible. The mounting height of the outboard motor greatly affects the water resistance. If the mounting height is too high, cavitation tends to occur, thus reducing the propulsion; and if the propeller tips cut the air, the engine speed will rise abnormally and cause the engine to overheat. If the mounting height is too low, the water resistance will increase and thereby reduce engine efficiency. Mount the outboard motor so that the anti-cavitation plate is in alignment with the bottom of the boat.

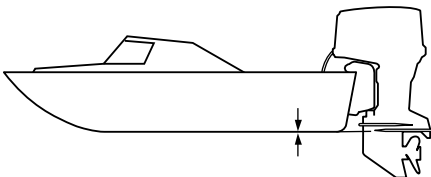

ZMU01874

**NOTE:** \_\_\_\_\_

- The optimum mounting height of the out-

board motor is affected by the boat/motor combination and the desired use. Test runs at different heights can help determine the optimum mounting height. Consult your Yamaha dealer or boat manufacturer for further information on determining the proper mounting height.

- For instructions on setting the trim angle of the outboard motor, see page 29.

EMU30172

## Breaking in engine

Your new engine requires a period of break-in to allow mating surfaces of moving parts to wear in evenly. Correct break-in will help ensure proper performance and longer engine life.

ECM00800

### CAUTION:

**Failure to follow the break-in procedure could result in reduced engine life or even severe engine damage.**

EMU27080

## Procedure for 4-stroke models

Run the engine under load (in gear with a propeller installed) as follows.

1. For the first hour of operation:  
Run the engine at 2000 r/min or at approximately half throttle.
2. For the second hour of operation:  
Run the engine at 3000 r/min or at approximately three-quarter throttle.
3. For the next eight hours of operation:  
Avoid continuous operation at full throttle for more than five minutes at a time.
4. After the first 10 hours:  
Operate the engine normally.

EMU27101

## Preoperation checks

EWM00080



**If any item in the preoperation check is**

not working properly, have it inspected and repaired before operating the outboard motor. Otherwise an accident could occur.

ECM00120

## CAUTION:

Do not start the engine out of water. Overheating and serious engine damage can occur.

EMU27110

## Fuel

- Check to be sure you have plenty of fuel for your trip.
- Make sure there are no fuel leaks or gasoline fumes.
- Check fuel line connections to be sure they are tight (if equipped Yamaha fuel tank or boat tank).
- Be sure the fuel tank is positioned on a secure, flat surface, and that the fuel line is not twisted or flattened, or likely to contact sharp objects (if equipped Yamaha fuel tank or boat tank).

EMU27130

## Controls

- Check throttle, shift, and steering for proper operation before starting the engine.
- The controls should work smoothly, without binding or unusual free play.
- Look for loose or damaged connections.
- Check operation of the starter and stop switches when the outboard motor is in the water.

EMU27150

## Engine

- Check the engine and engine mounting.
- Look for loose or damaged fasteners.
- Check the propeller for damage.
- Check that the battery is in good condition and the battery connections are secure.

EMU27163

## Checking the engine oil level

1. Put the outboard motor in an upright position (not tilted).
2. Remove oil dipstick and wipe it clean.
3. Completely insert the dipstick and remove it again.
4. Check the oil level using the dipstick to be sure the level falls between the upper and lower marks. Fill with oil if it is below the lower mark, or drain to the specified level if it is above the upper mark.

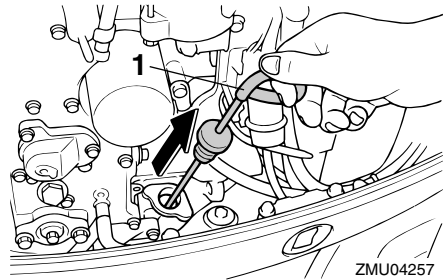

ZMU04257

1. Oil dipstick

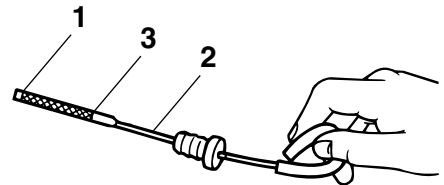

ZMU02082

1. Lower level mark
2. Oil dipstick
3. Upper level mark

## NOTE:

Be sure to completely insert the dipstick into the dipstick guide.

# Operation

EMU30021

## Filling fuel

EWM00060

### **WARNING**

Gasoline and its vapors are highly flammable and explosive. Keep away from sparks, cigarettes, flames, or other sources of ignition.

1. Remove the fuel tank cap.
2. Carefully fill the fuel tank.
3. Securely close the cap after filling the tank. Wipe up any spilled fuel.

EMU27450

## Operating engine

EMU27480

### Feeding fuel

EWM00420

### **WARNING**

- Before starting the engine, make sure that the boat is tightly moored and that you can steer clear of any obstructions. Be sure there are no swimmers in the water near you.
- When the air vent screw is loosened, gasoline vapor will be released. Gasoline is highly flammable, and its vapors are flammable and explosive. Refrain from smoking, and keep away from open flames and sparks while loosening the air vent screw.
- This product emits exhaust gases which contain carbon monoxide, a colorless, odorless gas which could cause brain damage or death when inhaled. Symptoms include nausea, dizziness, and drowsiness. Keep cockpit and cabin areas well ventilated. Avoid blocking exhaust outlets.

1. If there is an air vent screw on the fuel tank cap, loosen it 2 or 3 turns.
2. If there is a fuel joint or a fuel cock on the

boat, firmly connect the fuel line to the joint or open the fuel cock.

3. Squeeze the primer pump with the outlet end up until you feel it become firm.

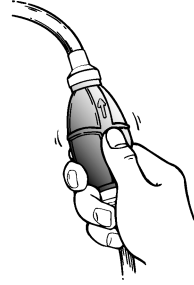

ZMU01770

EMU27490

### Starting engine

EMU27624

#### Electric start and remote control models

1. Place the remote control lever in “N” (neutral).

#### **NOTE:**

The start-in-gear protection device prevents the engine from starting except when in neutral.

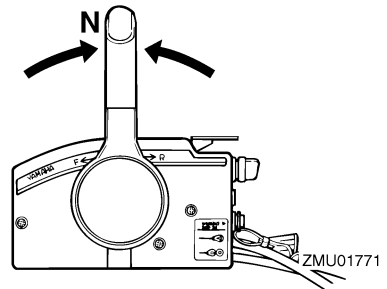

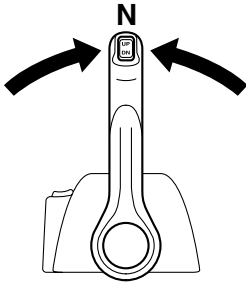

ZMU04588

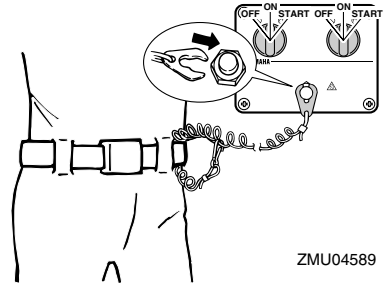

ZMU04589

2. Attach the engine stop switch lanyard to a secure place on your clothing, or your arm or leg. Then install the lock plate on the other end of the lanyard into the engine stop switch.

EWM00120

## **WARNING**

- Attach the engine stop switch lanyard to a secure place on your clothing, or your arm or leg while operating.
- Do not attach the lanyard to clothing that could tear loose. Do not route the lanyard where it could become entangled, preventing it from functioning.
- Avoid accidentally pulling the lanyard during normal operation. Loss of engine power means the loss of most steering control. Also, without engine power, the boat could slow rapidly. This could cause people and objects in the boat to be thrown forward.

3. Turn the main switch to “ON” (on).

## **NOTE:**

Dual engine users: When the main switch is turned on, the buzzer operates for a few seconds then stops automatically. The buzzer also operates if one of the engines stalls.

4. Turn the main switch to “START” (start), and hold it for a maximum of 5 seconds.

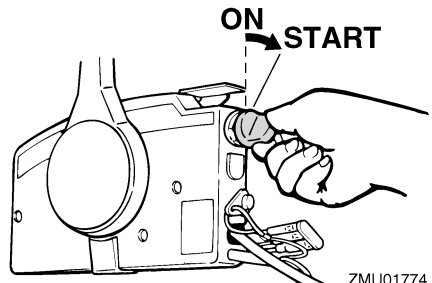

ZMU01774

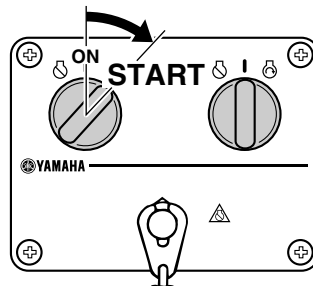

ZMU04590

5. Immediately after the engine starts, release the main switch to return it to “ON”

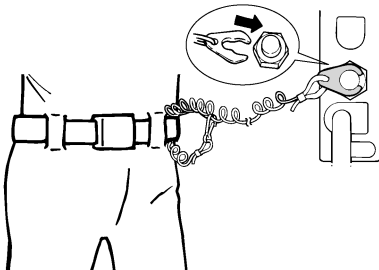

ZMU01772

# Operation

---

(on).

ECM00191

## CAUTION:

---

- Never turn the main switch to “START” (start) while the engine is running.
  - Do not keep the starter motor turning for more than 5 seconds. If the starter motor is turned continuously for more than 5 seconds, the battery will be quickly discharged, thus making it impossible to start the engine. The starter can also be damaged. If the engine will not start after 5 seconds of cranking, return the main switch to “ON” (on), wait 10 seconds, then crank the engine again.
- 

EMU27670

## Warming up engine

EMU27710

### Manual start and electric start models

1. After starting the engine, allow it to idle for 3 minutes to warm up. Failure to do so will shorten engine life.
2. Be sure the low oil pressure warning indicator goes off after starting the engine.
3. Check for a steady flow of water from the cooling water pilot hole.

ECM00210

## CAUTION:

---

- If the low oil pressure warning indicator does not go off after the engine starts, stop the engine. Otherwise serious engine damage could occur. Check the oil level and add oil if necessary. Consult your Yamaha dealer if the cause for the low oil pressure warning indicator cannot be found.
- A continuous flow of water from the pilot hole shows that the water pump is pumping water through the cooling

passages. If water is not flowing out of the pilot hole at all times while the engine is running, overheating and serious damage could occur. Stop the engine and check whether the cooling water inlet on the lower case or the cooling water pilot hole is blocked. Consult your Yamaha dealer if the problem cannot be located and corrected.

---

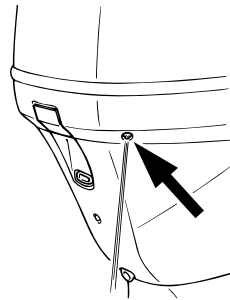

ZMU04229

EMU27740

## Shifting

EWM00180

## WARNING

---

Before shifting, make sure there are no swimmers or obstacles in the water near you.

---

ECM00220

## CAUTION:

---

To change the boat direction or shifting position from forward to reverse or vice-versa, first close the throttle so that the engine idles (or runs at low speeds).

---

EMU27763

### Forward (tiller handle and remote control models)

#### Tiller control models

1. Place the throttle grip in the fully closed position.
2. Move the gear shift lever quickly and firmly from neutral to forward.



## Remote control models

1. Pull up the neutral interlock trigger (if equipped) and move the remote control lever quickly and firmly from neutral to forward.

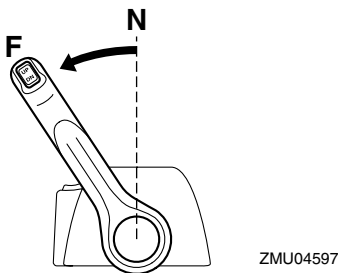
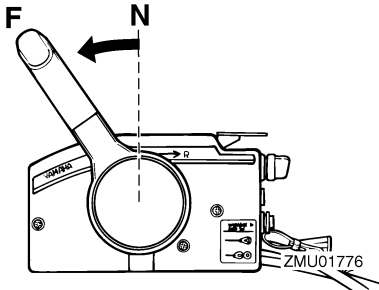

EMU27784

## Reverse (automatic reverse lock and power trim and tilt models)

EWMO0190



**WARNING**

When operating in reverse, go slowly. Do not open the throttle more than half. Otherwise the boat could become unstable, which could result in loss of control and an accident.

## Tiller control models

1. Place the throttle grip in the fully closed position.
2. Move the gear shift lever quickly and firmly from neutral to reverse.

## Remote control models

1. Pull up the neutral interlock trigger (if equipped) and move the remote control lever quickly and firmly from neutral to reverse.

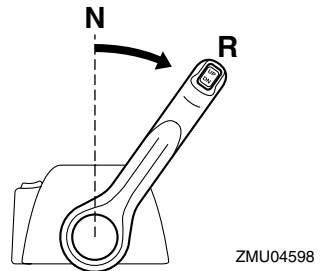
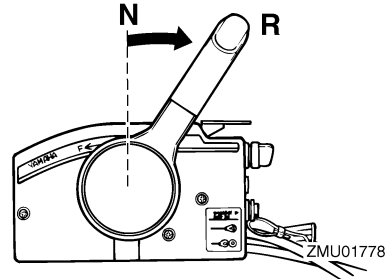

EMU27820

## Stopping engine

Before stopping the engine, first let it cool off for a few minutes at idle or low speed. Stopping the engine immediately after operating at high speed is not recommended.

EMU27844

## Procedure

1. Push and hold the engine stop button or turn the main switch to "OFF" (off).

# Operation

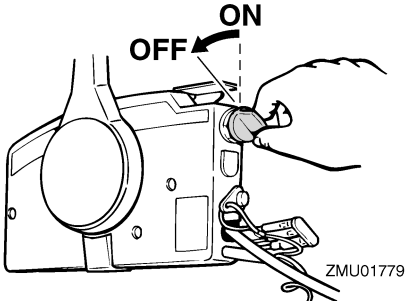
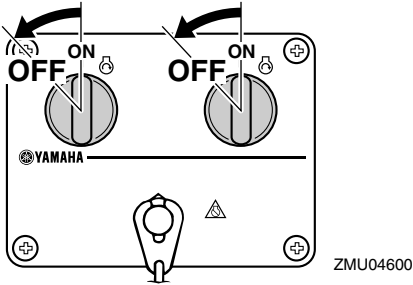

2. After stopping the engine, disconnect the fuel line if there is a fuel joint on the outboard motor.
3. Tighten the air vent screw on the fuel tank cap (if equipped).
4. Remove the key if the boat will be left unattended.

## NOTE:

The engine can also be stopped by pulling the lanyard and removing the lock plate from the engine stop switch, then turning the main switch to "OFF" (off).

EMU27861

## Trimming outboard motor

The trim angle of the outboard motor helps determine the position of the bow of the boat in the water. Correct trim angle will help improve performance and fuel economy while reducing strain on the engine. Correct trim angle depends upon the combination of

boat, engine, and propeller. Correct trim is also affected by variables such as the load in the boat, sea conditions, and running speed.

EWM00740

## WARNING

Excessive trim for the operating conditions (either trim up or trim down) can cause boat instability and can make steering the boat more difficult. This increases the possibility of an accident. If the boat begins to feel unstable or is hard to steer, slow down and/or readjust the trim angle.

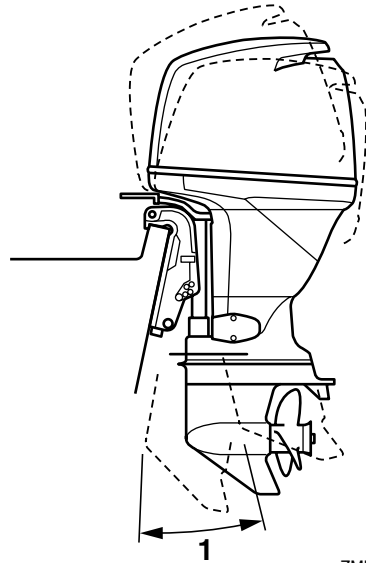

ZMU04258

1. Trim operating angle

EMU27881

## Adjusting trim angle

### Power trim and tilt models

EWM00750

## WARNING

- Be sure all people are clear of the outboard motor when adjusting the tilt an-

gle, also be careful not to pinch any body parts between the drive unit and clamp bracket.

- Use caution when trying a trim position for the first time. Increase speed gradually and watch for any signs of instability or control problems. Improper trim angle can cause loss of control.
- Use the power tilt switch located on the bottom engine cowling (if equipped) only when the boat is at a complete stop with the engine off.

Adjust the outboard motor trim angle using the power trim and tilt switch.

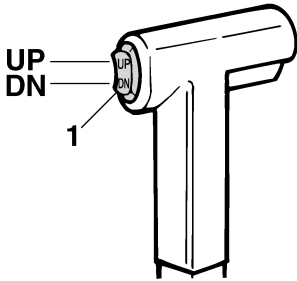

1. Power trim and tilt switch

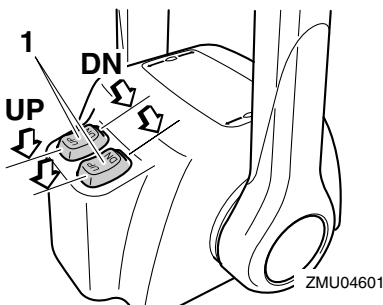

1. Power trim and tilt switch

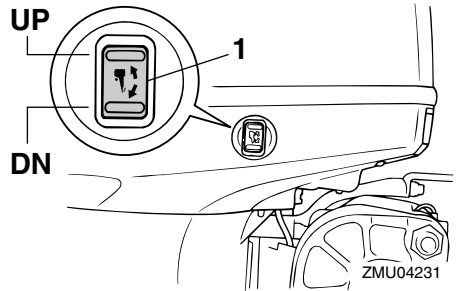

1. Power trim and tilt switch

To raise the bow (trim-out), press the switch “UP” (up).

To lower the bow (trim-in), press the switch “DN” (down).

Make test runs with the trim set to different angles to find the position that works best for your boat and operating conditions.

## NOTE:

To adjust the trim angle while the boat is moving, use the power trim and tilt switch located on the remote control device or tiller handle, if equipped.

EMU27911

## Adjusting boat trim

When the boat is on plane, a bow-up attitude results in less drag, greater stability and efficiency. This is generally when the keel line of the boat is up about 3 to 5 degrees. With the bow up, the boat may have a greater tendency to steer to one side or the other. Compensate for this as you steer. The trim tab can also be adjusted to help offset this effect. When the bow of the boat is down, it is easier to accelerate from a standing start onto plane.

# Operation

---

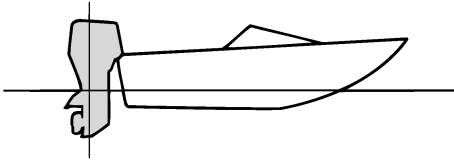

ZMU01784

## Bow Up

Too much trim-out puts the bow of the boat too high in the water. Performance and economy are decreased because the hull of the boat is pushing the water and there is more air drag. Excessive trim-out can also cause the propeller to ventilate, which reduces performance further, and the boat may “porpoise” (hop in the water), which could throw the operator and passengers overboard.

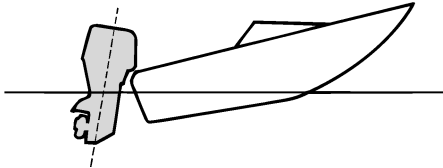

ZMU01785

## Bow Down

Too much trim-in causes the boat to “plow” through the water, decreasing fuel economy and making it hard to increase speed. Operating with excessive trim-in at higher speeds also makes the boat unstable. Resistance at the bow is greatly increased, heightening the danger of “bow steering” and making operation difficult and dangerous.

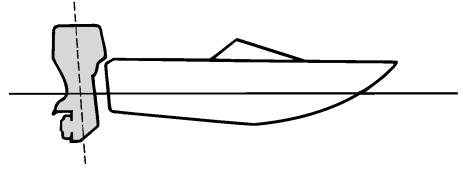

ZMU01786

## NOTE:

Depending on the type of boat, the outboard motor trim angle may have little effect on the trim of the boat when operating.

EMU27931

## Tilting up and down

If the engine will be stopped for some time or if the boat is moored in shallows, the outboard motor should be tilted up to protect the propeller and casing from damage by collision with obstructions, and also to reduce salt corrosion.

EWM00220

## WARNING

Be sure all people are clear of the outboard motor when tilting up and down, also be careful not to pinch any body parts between the drive unit and engine bracket.

EWM00250

## WARNING

Leaking fuel is a fire hazard. If there is a fuel joint on the outboard motor, disconnect the fuel line or close the fuel cock if the engine will be tilted for more than a few minutes. Otherwise fuel may leak.

ECM00241

## CAUTION:

- Before tilting the outboard motor, stop the engine by following the procedure

on page 28. Never tilt the outboard motor while the engine is running. Severe damage from overheating can result.

- Do not tilt up the engine by pushing the tiller handle (if equipped) because this could break the handle.

EMU28005

## Procedure for tilting up

Power trim and tilt models / power tilt models

1. Place the remote control lever / the gear shift lever in neutral.

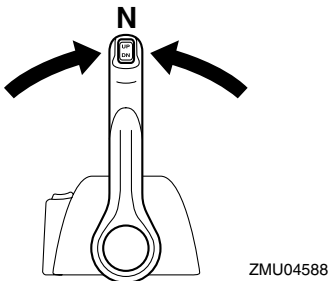
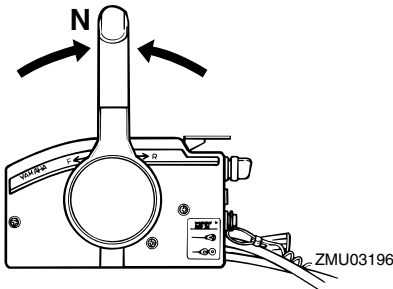

2. Disconnect the fuel line from the outboard motor or close the fuel cock.
3. Press the power trim and tilt switch / power tilt switch "UP" (up) until the outboard motor has tilted up completely.

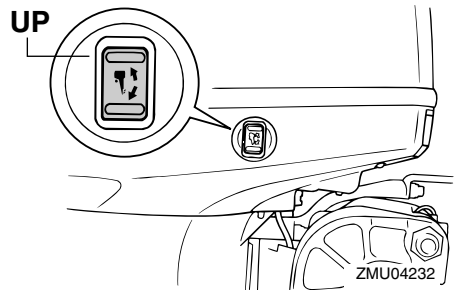
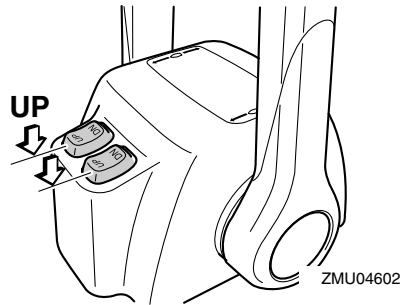
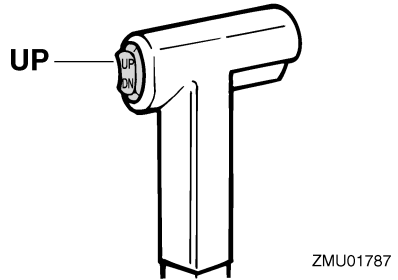

4. Push the tilt support knob into the clamp bracket or pull the tilt support lever toward you to support the engine.

# Operation

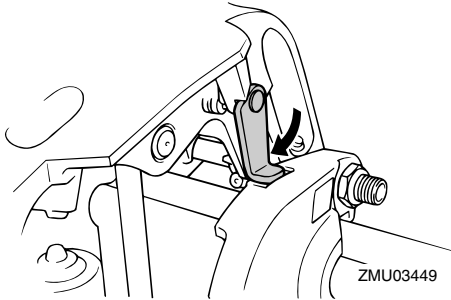

EWM00260

## **WARNING**

After tilting the outboard motor, be sure to support it with the tilt support knob or tilt support lever. Otherwise the outboard motor could fall back down suddenly if oil in the power trim and tilt unit loses pressure.

5. Models equipped with trim rods: Once the outboard motor is supported with the tilt support lever, press the power trim and tilt switch “DN” (down) to retract the trim rods.

ECM00250

## **CAUTION:**

Be sure to retract the trim rods completely during mooring. This protects the rods from marine growth and corrosion which could damage the power trim and tilt mechanism.

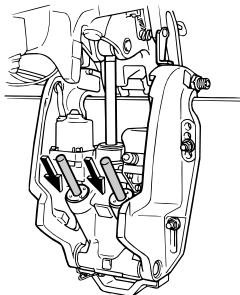

EMU28052

## **Procedure for tilting down**

### Power trim and tilt models / power tilt models

1. Push the power tilt / power trim and tilt switch “UP” (up) until the outboard motor is supported by the tilt rod and the tilt support lever / tilt support knob becomes free.
2. Release the tilt support lever or pull out the tilt support knob.

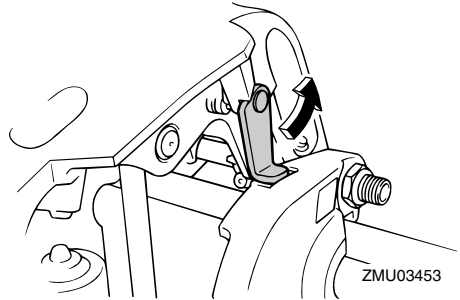

3. Push the power tilt / power trim and tilt switch “DN” (down) to lower the outboard motor to the desired position.

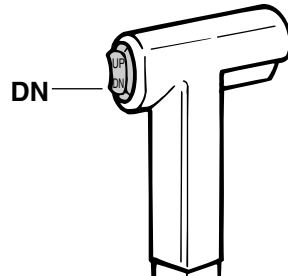

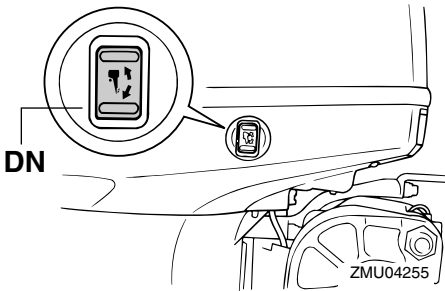
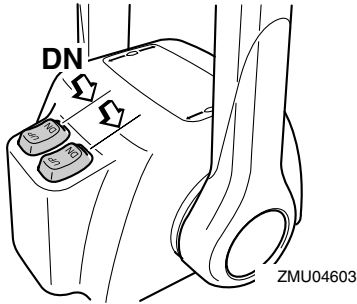

EMU28060

## Cruising in shallow water

The outboard motor can be tilted up partially to allow operation in shallow water.

EMU28090

## Power trim and tilt models / power tilt models

The outboard motor can be tilted up partially to allow operation in shallow water.

EWM00660

### **WARNING**

- Place the gear shift in neutral before setting up for shallow water cruising.
- Return the outboard motor to its normal position as soon as the boat is back in deeper water.

ECM00260

### **CAUTION:**

Do not tilt the outboard motor up so that the cooling water inlet on the lower unit is above the surface of the water when set-

ting up for and cruising in shallow water. Otherwise severe damage from overheating can result.

EMU28184

## Procedure for power trim and tilt / power tilt models

1. Place the gear shift lever in neutral.

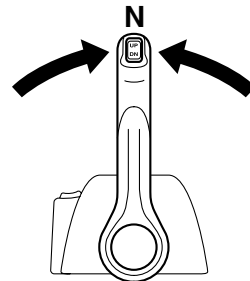
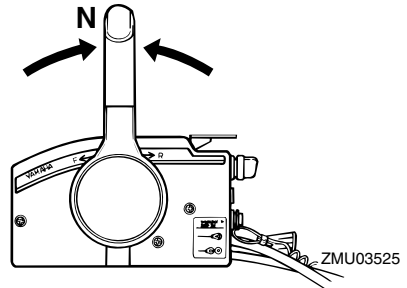

2. Slightly tilt the outboard motor up to the desired position using the power trim / tilt switch.

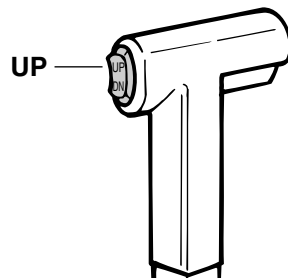

# Operation

---

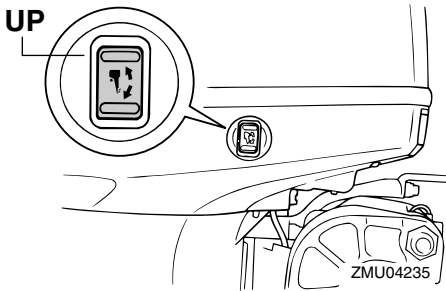
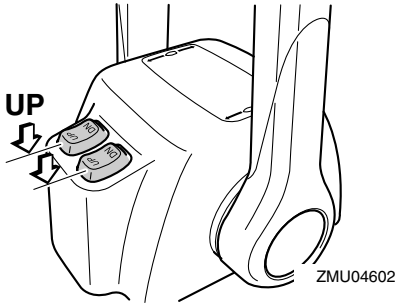

3. To return the outboard motor to the normal running position, press the power trim / tilt switch and slowly tilt the outboard motor down.

EMU28190

## Cruising in other conditions

### Cruising in salt water

After operating in salt water, wash out the cooling water passages with fresh water to prevent them from becoming clogged with salt deposits.

#### **NOTE:**

For cooling system flushing instructions, see page 37.

### Cruising in turbid water

Yamaha strongly recommends that you use the optional chromium-plated water pump kit if you use the outboard motor in turbid (muddy) water conditions.



EMU28215

## Specifications

### Dimension:

- Overall length:  
825 mm (32.5 in)
- Overall width:  
498 mm (19.6 in)
- Overall height L:  
F115AET 1609 mm (63.3 in)
- Overall height X:  
1736 mm (68.3 in)
- Transom height L:  
F115AET 516 mm (20.3 in)
- Transom height X:  
643 mm (25.3 in)
- Weight (AL) L:  
F115AET 186.0 kg (410 lb)
- Weight (AL) X:  
F115AET 191.0 kg (421 lb)
- Weight (SUS) L:  
F115AET 188.0 kg (414 lb)
- Weight (SUS) X:  
193.0 kg (425 lb)

### Performance:

- Full throttle operating range:  
5000–6000 r/min
- Maximum output:  
84.6 kW @ 5500 r/min (115 HP @ 5500 r/min)
- Idling speed (in neutral):  
750 ±50 r/min

### Engine:

- Type:  
4-stroke L
- Displacement:  
1741.0 cm<sup>3</sup> (106.24 cu.in)
- Bore × stroke:  
79.0 × 88.8 mm (3.11 × 3.50 in)
- Ignition system:  
TCI
- Spark plug (NGK):

LFR6A-11

Spark plug with resistor (NGK):

LFR6A-11

Spark plug gap:

1.0–1.1 mm (0.039–0.043 in)

Control system:

Remote control

Starting system:

Electric

Starting carburetion system:

Electronic fuel injection

Valve clearance (cold engine) IN:

0.17–0.23 mm (0.0067–0.0091 in)

Valve clearance (cold engine) EX:

0.31–0.37 mm (0.0122–0.0146 in)

Min. cold cranking amps (CCA/EN):

430.0 A

Min. rated capacity (20HR/IEC):

70.0 Ah

Alternator output for battery DC:

25.0 A

### Drive unit:

Gear positions:

Forward-neutral-reverse

Gear ratio:

2.15 (28/13)

Trim and tilt system:

Power trim and tilt

Propeller mark:

F115AET K

FL115AET KL

### Fuel and oil:

Recommended fuel:

Regular unleaded gasoline

Min. research octane:

90

Recommended engine oil:

4-stroke outboard motor oil

Engine oil grade API:

API SE, SF, SG, SH, SJ

Engine oil type SAE:

# Maintenance

SAE10W30 or SAE10W40

Lubrication:

Wet sump

Engine oil quantity (excluding oil filter):

4.3 L (4.55 US qt) (3.78 Imp.qt)

Recommended gear oil:

Hypoid gear oil SAE#90

Gear oil quantity:

F115AET 760.0 cm<sup>3</sup> (25.70 US oz)  
(26.81 Imp.oz)

FL115AET 715.0 cm<sup>3</sup> (24.18 US oz)  
(25.17 Imp.oz)

## Tightening torque for engine:

Spark plug:

25.0 Nm (18.4 ft-lb) (2.55 kgf-m)

Propeller nut:

55.0 Nm (40.6 ft-lb) (5.61 kgf-m)

Engine oil drain bolt:

28.0 Nm (20.7 ft-lb) (2.86 kgf-m)

Engine oil filter:

18.0 Nm (13.3 ft-lb) (1.84 kgf-m)

EMU28222

## Transporting and storing outboard motor

EWM00690

### WARNING

- Leaking fuel is a fire hazard. When transporting and storing the outboard motor, close the air vent screw and fuel cock to prevent fuel from leaking.
- USE CARE when transporting fuel tank, whether in a boat or car.
- DO NOT fill fuel container to maximum capacity. Gasoline will expand considerably as it warms up and can build up pressure in the fuel container. This can cause fuel leakage and a potential fire hazard.

EWM00700

### WARNING

Never get under the lower unit while it is

tilted, even if a motor support bar is used. Severe injury could occur if the outboard motor accidentally falls.

ECM00660

### CAUTION:

Do not use the tilt support lever or knob when trailering the boat. The outboard motor could shake loose from the tilt support and fall. If the motor cannot be trailered in the normal running position, use an additional support device to secure it in the tilt position.

The outboard motor should be trailered and stored in the normal running position. If there is insufficient road clearance in this position, then trailer the outboard motor in the tilt position using a motor support device such as a transom saver bar. Consult your Yamaha dealer for further details.

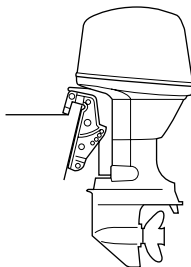

ZMU03659

EMU28290

## Storing outboard motor

When storing your Yamaha outboard motor for prolonged periods of time (2 months or longer), several important procedures must be performed to prevent excessive damage. It is advisable to have your outboard motor serviced by an authorized Yamaha dealer prior to storage. However, you, the owner, with a minimum of tools, can perform the fol-

lowing procedures.

ECM00600

## CAUTION:

- To prevent problems which can be caused by oil entering the cylinder from the sump, keep the outboard motor in the attitude shown when transporting and storing it. If storing or transporting the outboard motor on its side (not upright), put it on a cushion after draining the engine oil.
- Do not place the outboard motor on its side before the cooling water has drained from it completely, otherwise water may enter the cylinder through the exhaust port and cause engine trouble.
- Store the outboard motor in a dry, well-ventilated place, not in direct sunlight.
- Drain the remaining gasoline from the vapor separator. Gasoline left in the vapor separator for a prolonged period of time will break down and could cause damage to the fuel line.

EMU28301

## Procedure

EMU29953

### Flushing with the flushing attachment

1. Wash the outboard motor body using fresh water. For further information, see page 41.
2. Disconnect the fuel line from the motor or shut off the fuel cock, if equipped.
3. Remove the top cowling and propeller.
4. Install the flushing attachment over the cooling water inlet.

ECM00300

## CAUTION:

**Do not run the engine without supplying it with cooling water. Either the engine water pump will be damaged or the en-**

**gine will be damaged from overheating. Before starting the engine, be sure to supply water to the cooling water passages.**

ECM00310

## CAUTION:

**Avoid running the outboard motor at high speed while on the flushing attachment, otherwise overheating could occur.**

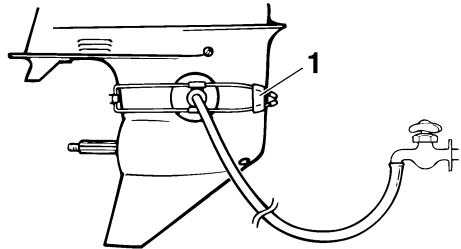

ZMU01830

1. Flushing attachment

5. Cooling system flushing is essential to prevent the cooling system from clogging up with salt, sand, or dirt. In addition, fogging/lubricating the engine is mandatory to prevent excessive engine damage due to rust. Perform the flushing and fogging at the same time.

EWM00090

## WARNING

- Do not touch or remove electrical parts when starting or during operation.
- Keep hands, hair, and clothes away from the flywheel and other rotating parts while the engine is running.

## NOTE:

- When using the flushing attachment, maintain adequate water pressure and a steady water flow.
- If the overheat warning device is activated,

# Maintenance

turn the engine off, and consult your Yamaha dealer.

- Run the engine at a fast idle for a few minutes in neutral position.
- Just prior to turning off the engine, quickly spray "Fogging Oil" alternately into the intake silencer or the fogging hole of the silencer cover, if equipped. When properly done, the engine will smoke excessively and almost stall.
- Drain the remained gasoline in the vapor separator with a container. Loosen the drain screw, and then remove the cap. Push in the air valve with a screwdriver to introduce air into the float chamber, so that the gasoline will drain smoothly. Then, tighten the drain screw.

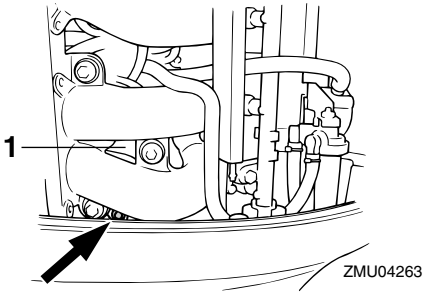

- Vapor separator
- Remove the flushing attachment.
- Install the top cowling.
- If "Fogging Oil" is not available, turn off the engine after the 6 step. Then perform the 8 step procedure.
- Drain the cooling water completely out of the motor. Clean the body thoroughly.
- If the "Fogging Oil" is not available, remove the spark plug(s). Pour a teaspoonful of clean engine oil into each cylinder. Crank several times manually.

Replace the spark plug(s).

## NOTE:

A flushing attachment is available from your Yamaha dealer.

EMU28400

## Lubrication (except oil injection models)

- Grease the spark plug threads and install the spark plug(s) and torque to proper specification. For information on spark plug installation, see page 44.
- Change the gear oil. For instructions, see page 52. Inspect the oil for the presence of water that indicates a leaky seal. Seal replacement should be performed by an authorized Yamaha dealer prior to use.
- Grease all grease fittings. For further details, see page 44.

EMU28430

## Battery care

EWM00330

### WARNING

**Battery electrolytic fluid is dangerous; it contains sulfuric acid and therefore is poisonous and highly caustic.**

**Always follow these preventive measures:**

- Avoid bodily contact with electrolytic fluid as it can cause severe burns or permanent eye injury.
- Wear protective eye gear when handling or working near batteries.

#### Antidote (EXTERNAL):

- SKIN - Flush with water.
- EYES - Flush with water for 15 minutes and get immediate medical attention.

#### Antidote (INTERNAL):

- Drink large quantities of water or milk followed by milk of magnesia, beaten egg, or vegetable oil. Get immediate

medical attention.

Batteries also generate explosive hydrogen gas; therefore, you should always follow these preventive measures:

- Charge batteries in a well-ventilated area.
- Keep batteries away from fire, sparks, or open flames (for example: welding equipment, lighted cigarettes, and so on.)
- **DO NOT SMOKE** when charging or handling batteries.

**KEEP BATTERIES AND ELECTROLYTIC FLUID OUT OF REACH OF CHILDREN.**

Batteries vary among manufacturers. Therefore the following procedures may not always apply. Consult your battery manufacturer's instructions.

### Procedure

1. Disconnect and remove the battery from the boat. Always disconnect the black negative cable first to prevent the risk of shorting.
2. Clean the battery casing and terminals. Fill each cell to the upper level with distilled water.
3. Store the battery on a level surface in a cool, dry, well-ventilated place out of direct sunlight.
4. Once a month, check the specific gravity of the electrolyte and recharge as required to prolong battery life.

EMU28440

### **Flushing power unit**

Perform this procedure right after operation for the most thorough flushing.

1. After shutting off the engine, unscrew the garden hose connector from the fitting on the bottom cowling.

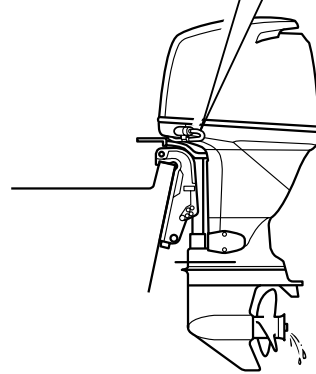
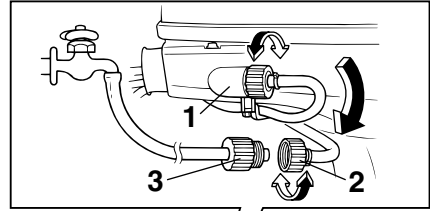

ZMU04264

1. Fitting
  2. Garden hose connector
  3. Garden hose
2. Screw the garden hose connector onto a garden hose which is connected to a fresh water supply.
  3. With the engine off, turn on the water tap and let the water flush through the cooling passages for about 15 minutes. Turn off the water and disconnect the garden hose.
  4. When flushing is complete, reinstall the garden hose connector on the fitting on the bottom cowling. Tighten the connector securely.

ECM00540

### **CAUTION:**

**Do not leave the garden hose connector loose on the bottom cowling fitting or let the hose hang free during normal operation. Water will leak out of the connector**

# Maintenance

---

instead of cooling the engine, which can cause serious overheating. Be sure the connector is tightened securely on the fitting after flushing the engine.

**NOTE:** \_\_\_\_\_

- When flushing the engine with the boat in the water, tilting up the outboard motor until it is completely out of the water will achieve better results.
- For cooling system flushing instructions, see page 37.

EMU28450

## Cleaning the outboard motor

After use, wash the exterior of the outboard motor with fresh water. Flush the cooling system with fresh water.

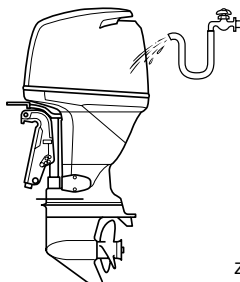

ZMU04265

**NOTE:** \_\_\_\_\_

For cooling system flushing instructions, see page 37.

EMU28460

## Checking painted surface of motor

Check the motor for scratches, nicks, or flaking paint. Areas with damaged paint are more likely to corrode. If necessary, clean and paint the areas. A touch-up paint is available from your Yamaha dealer.

EMU28474

## Periodic maintenance

EWM01070



**WARNING**

Be sure to turn off the engine when you perform maintenance unless otherwise specified. If you or the owner is not familiar with machine servicing, this work should be done by your Yamaha dealer or other qualified mechanic.

EMU28510

## Replacement parts

If replacement parts are necessary, use only genuine Yamaha parts or parts of the same type and of equivalent strength and materials. Any part of inferior quality may malfunction, and the resulting loss of control could endanger the operator and passengers. Yamaha genuine parts and accessories are available from your Yamaha dealer.

EMU30560

## Maintenance chart

### NOTE:

- Refer to the sections in this chapter for explanations of each owner-specific action.
- The maintenance cycle on these charts assume usage of 200 hours per year. Maintenance frequency should be adjusted according to usage conditions.
- Disassembly or repairs may be necessary depending on the outcome of maintenance checks.
- Expendable or consumable parts and lubricants will lose their effectiveness over time and through normal usage regardless of the warranty period.

The “●” symbol indicates the check-ups which you may carry out yourself.

The “○” symbol indicates work to be carried out by your Yamaha dealer.

Item	Actions	Initial		Every	
		10 hours (1 month)	50 hours (3 months)	100 hours (6 months)	200 hours (1 year)
Anode(s) (external)	Inspection / replacement		●/○	●/○	
Anode(s) (internal)	Inspection / replacement				○
Battery	Inspection / charging	●/○			
Cooling water passages	Cleaning		●	●	
Cowling clamp	Inspection				●
Fuel filter (can be disassembled)	Inspection / cleaning	●	●	●	
Fuel system	Inspection	●	●	●	
Gear oil	Change	●		●	
Greasing points	Greasing			●	
Idling speed (EFI models)	Inspection / adjustment				○
PCV (Pressure Control Valve)	Inspection				○
Power trim and tilt unit	Inspection				○
Propeller and cotter pin	Inspection / replacement		●	●	
Shift link / shift cable	Inspection / adjustment				○
Thermostat	Inspection				○

# Maintenance

Item	Actions	Initial		Every	
		10 hours (1 month)	50 hours (3 months)	100 hours (6 months)	200 hours (1 year)
Throttle link / throttle cable / throttle pick-up timing	Inspection / adjustment				○
Water pump	Inspection				○
Engine oil	Inspection / change	●		●	
Oil filter (cartridge)	Change				○
Spark plug(s)	Cleaning / adjustment / replacement	●			●
Timing belt	Inspection / replacement			○	○

**NOTE:** \_\_\_\_\_

When operating in salt water, turbid or muddy water, the engine should be flushed with clean water after each use.

EMU28871

## Maintenance chart (additional)

Item	Actions	Every	
		500 hours (2.5 years)	1000 hours (5 years)
Timing belt	Replacement		○
Valve clearance (DOHC)	Inspection / adjustment	○	

EMU28910

**NOTE:** \_\_\_\_\_

When using lead or high-sulfur gasoline, inspecting valve clearance may be required more frequently than every 500 hours.



EMU28940

## Greasing

Yamaha grease A (water resistant grease)

Yamaha grease D (corrosion resistant grease; for propeller shaft)

F115A, FL115A

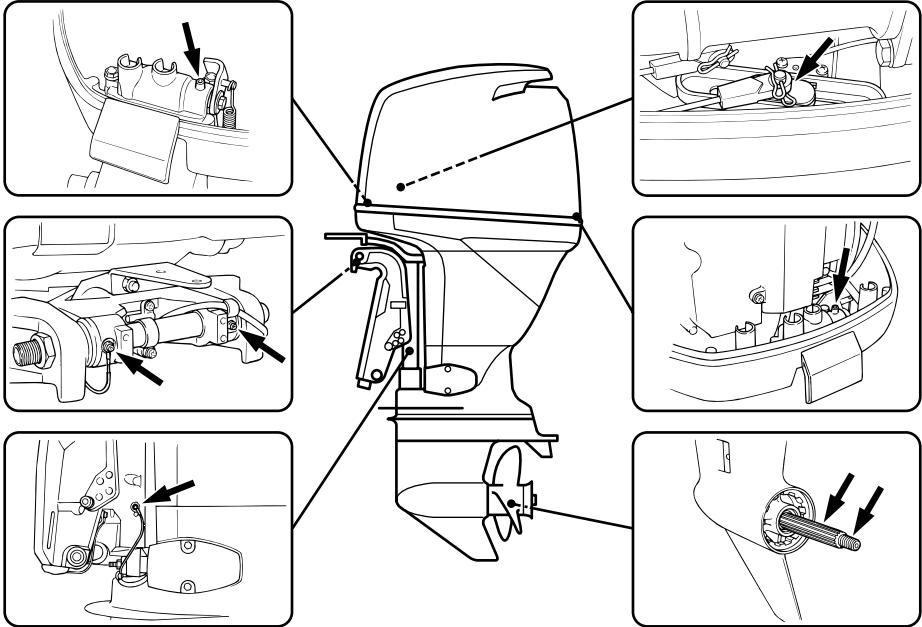

ZMU04266

EMU28951

## Cleaning and adjusting spark plug

EWM00560



### WARNING

**When removing or installing a spark plug, be careful not to damage the insulator. A damaged insulator could allow external sparks, which could lead to explosion or fire.**

The spark plug is an important engine component and is easy to inspect. The condition of the spark plug can indicate something about the condition of the engine. For example, if the center electrode porcelain is very white, this could indicate an intake air leak or

carburetion problem in that cylinder. Do not attempt to diagnose any problems yourself. Instead, take the outboard motor to a Yamaha dealer. You should periodically remove and inspect the spark plug because heat and deposits will cause the spark plug to slowly break down and erode. If electrode erosion becomes excessive, or if carbon and other deposits are excessive, you should replace the spark plug with another of the correct type.

Standard spark plug:  
LFR6A-11

Before fitting the spark plug, measure the

# Maintenance

electrode gap with a wire thickness gauge; adjust the gap to specification if necessary.

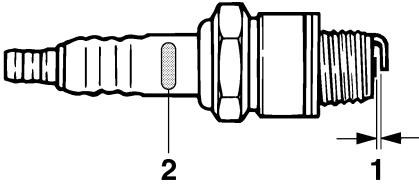

ZMU02179

1. Spark plug gap
2. Spark plug I.D. mark (NGK)

Spark plug gap:  
1.0–1.1 mm (0.039–0.043 in)

When fitting the plug, always clean the gasket surface and use a new gasket. Wipe off any dirt from the threads and screw in the spark plug to the correct torque.

Spark plug torque:  
25.0 Nm (18.4 ft-lb) (2.55 kgf-m)

## NOTE:

If a torque-wrench is not available when you are fitting a spark plug, a good estimate of the correct torque is 1/4 to 1/2 a turn past finger-tight. Have the spark plug adjusted to the correct torque as soon as possible with a torque-wrench.

EMU28962

## Checking fuel system

EWM00060

### **WARNING**

**Gasoline and its vapors are highly flammable and explosive. Keep away from sparks, cigarettes, flames, or other**

## sources of ignition.

EWM00910

### **WARNING**

**Leaking fuel can result in fire or explosion.**

- Check for fuel leakage regularly.
- If any fuel leakage is found, the fuel system must be repaired by a qualified mechanic. Improper repairs can make the outboard unsafe to operate.

Check the fuel lines for leaks, crack, or malfunction. If a problem is found, your Yamaha dealer or other qualified mechanic should repair it immediately.

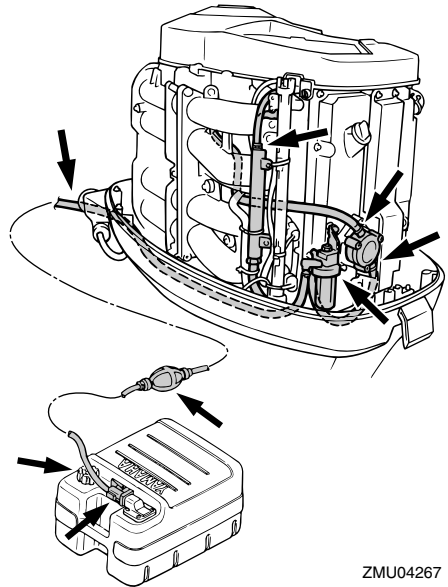

ZMU04267

## Checkpoints

- Fuel system parts leakage
- Fuel line joint leakage
- Fuel line cracks or other damage
- Fuel connector leakage

EMU28980

## Inspecting fuel filter

EWM00310

### **WARNING**

Gasoline is highly flammable, and its vapors are flammable and explosive.

- If you have any question about properly doing this procedure, consult your Yamaha dealer.
- Do not perform this procedure on a hot or running engine. Allow the engine to cool.
- There will be fuel in the fuel filter. Keep away from sparks, cigarettes, flames or other sources of ignition.
- This procedure will allow some fuel to spill. Catch fuel in a rag. Wipe up any spilled fuel immediately.
- The fuel filter must be reassembled carefully with the O-ring, filter cup, and hoses in place. Improper assembly or replacement could result in a fuel leak, which could result in a fire or explosion hazard.

EMU29021

## Cleaning fuel filter

### **NOTE:**

If any water is in the fuel, the float will rise. If so, remove the cup and drain the water.

1. Remove the nut holding the fuel filter assembly if so equipped.

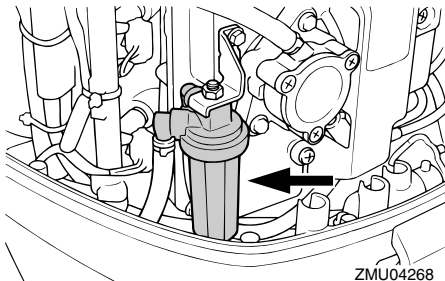

2. Unscrew the filter cup, catching any spilled fuel in a rag.
3. Remove the filter element, and wash it in solvent. Allow it to dry. Inspect the filter element and O-ring to make sure they are in good condition. Replace them if necessary. If any water is found in the fuel, the Yamaha portable fuel tank or other fuel tanks should be checked and cleaned.

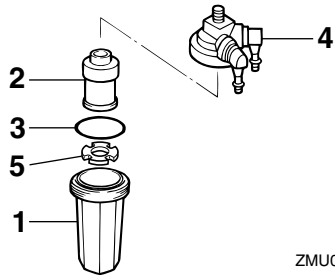

1. Filter cup
2. Filter element
3. O-ring
4. Filter housing
5. Float

4. Reinstall the filter element in the cup. Make sure the O-ring is in proper position in the cup. Firmly screw the cup onto the filter housing.
5. Attach the filter assembly to the bracket.
6. Run the engine and check the filter and lines for leaks.

EMU29040

## Inspecting idling speed

EWM00450

### **WARNING**

- Do not touch or remove electrical parts when starting or during operation.
- Keep hands, hair, and clothes away from the flywheel and other rotating

# Maintenance

---

parts while the engine is running.

- **2-hp models:** The propeller rotates whenever the engine is running. Do not move the throttle control lever from the start position during warm-up. The boat could unexpectedly start to move, which could result in an accident.
- 

ECM00490

## CAUTION:

This procedure must be performed while the outboard motor is in the water. A flushing attachment or test tank can be used.

---

A diagnostic tachometer should be used for this procedure. Results may vary depending on whether testing is conducted with the flushing attachment, in a test tank, or with the outboard motor in the water.

1. Start the engine and allow it to warm up fully in neutral until it is running smoothly.  
2-hp model: Warm the engine with the throttle in the start position or less. If the outboard is mounted on a boat, be sure the boat is tightly moored.

## NOTE:

Correct idling speed inspection is only possible if the engine is fully warmed up. If not warmed up fully, the idle speed will measure higher than normal. If you have difficulty verifying the idle speed, or the idle speed requires adjustment, consult a Yamaha dealer or other qualified mechanic.

---

2. Verify whether the idle speed is set to specification. For idle speed specifications, see page 36.

EMU29073

## Changing engine oil

EWM00760

### WARNING

- Avoid draining the engine oil immediately after stopping the engine. The oil is hot and should be handled with care to avoid burns.
  - Be sure the outboard motor is securely fastened to the transom or a stable stand.
- 

ECM00970

## CAUTION:

- Do not overfill the oil, and be sure the outboard motor is upright (not tilted) when checking and changing the engine oil.
  - If the oil level is above the upper level mark, drain until the level meets the specified capacity. Overfilling the oil could cause leakage or damage.
- 

ECM01240

## CAUTION:

Change the engine oil after the first 10 hours of operation, and every 100 hours or at 6-month intervals thereafter. Otherwise the engine will wear quickly.

---

## NOTE:

Change the engine oil when the oil is still warm.

---

1. Put the outboard motor in an upright position (not tilted).

# Maintenance

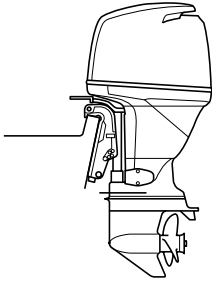

ZMU04270

2. Prepare a suitable container that holds a larger amount than the engine oil capacity. Loosen and remove the drain screw while holding the container under the drain hole. Then remove the oil filler cap. Let the oil drain completely. Wipe up any spilled oil immediately.

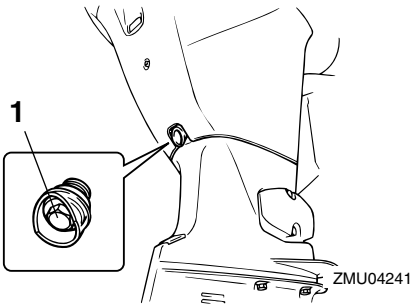

ZMU04241

1. Drain screw
3. Put a new gasket on the oil drain screw. Apply a light coat of oil to the gasket and install the drain screw.

Drain screw tightening torque:  
28.0 Nm (20.7 ft-lb) (2.86 kgf-m)

## NOTE:

If a torque wrench is not available when you are installing the drain screw, finger tighten the screw just until the gasket comes into contact with the surface of the drain hole.

Then tighten 1/4 to 1/2 turn more. Tighten the drain screw to the correct torque with a torque wrench as soon as possible.

4. Add the correct amount of oil through the filler hole. Install the filler cap.

Recommended engine oil:

4-stroke outboard motor oil

Engine oil quantity (excluding oil filter):

4.3 L (4.55 US qt) (3.78 Imp.qt)

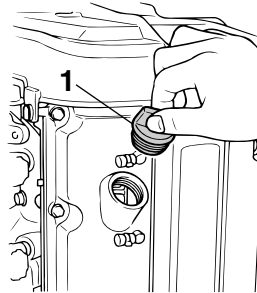

ZMU04271

1. Oil filler cap

5. Start the engine and watch to make sure the low oil pressure warning indicator (if equipped) turns off. Make sure that there are no oil leaks.

ECM00680

## CAUTION:

**If the low oil pressure warning indicator does not turn off or if there are oil leaks, stop the engine and find the cause. Continued operation with a problem could cause severe engine damage. Consult your Yamaha dealer if the problem cannot be located and corrected.**

6. Turn off the engine and wait 3 minutes. Recheck the oil level using the dipstick to be sure the level falls between the upper and lower marks. Fill with oil if it is below the lower mark, or drain to the

# Maintenance

specified level if it is above the upper mark.

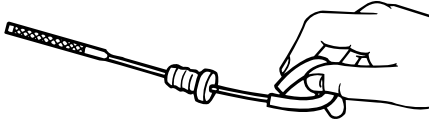

ZMU02058

7. Dispose of used oil according to local regulations.

**NOTE:** \_\_\_\_\_

- For more information on the disposal of used oil, consult your Yamaha dealer.
- Change the oil more often when operating the engine under adverse conditions such as extended trolling.

EMU29111

## Checking wiring and connectors

- Check that each grounding wire is properly secured.
- Check that each connector is engaged securely.

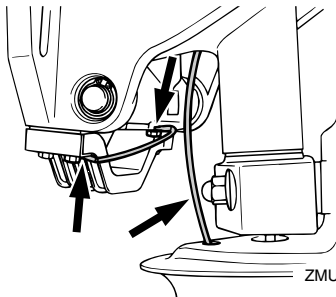

ZMU04286

EMU29120

## Exhaust leakage

Start the engine and check that no exhaust leaks from the joints between the exhaust cover, cylinder head, and body cylinder.

EMU29130

## Water leakage

Start the engine and check that no water leaks from the joints between the exhaust cover, cylinder head, and body cylinder.

EMU29140

## Engine oil leakage

Check for oil leaks on the around the engine.

**NOTE:** \_\_\_\_\_

If any leaks are found, consult your Yamaha dealer.

EMU29153

## Checking power trim and tilt system

EWM00430

**! WARNING** \_\_\_\_\_

- **Never get under the lower unit while it is tilted, even when the tilt support lever is locked. Severe injury could occur if the outboard motor accidentally falls.**
- **Make sure no one is under the outboard motor before performing this test.**

1. Check the power trim and tilt unit for any sign of oil leaks.
2. Operate each of the power trim and tilt switches on the remote control and engine bottom cowling (if equipped) to check that all switches work.
3. Tilt the outboard motor up and check that the tilt rod and trim rods are extended completely.

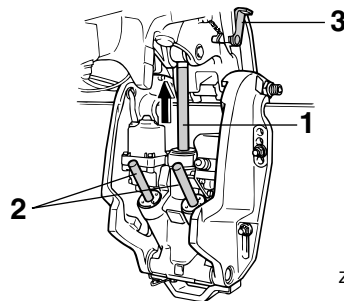

ZMU02633

1. Tilt rod

2. Trim rods
  3. Tilt support lever
4. Use the tilt support lever to lock the motor in the up position. Operate the tilt down switch briefly so the motor is supported by the tilt support lever.

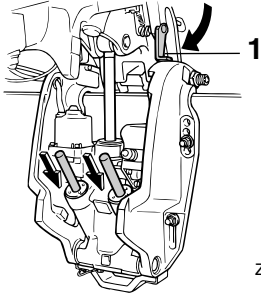

ZMU02634

1. Tilt support lever
5. Check that the tilt rod and trim rods are free of corrosion or other flaws.
6. Activate the tilt-down switch until the trim rods have retracted completely into the cylinders.

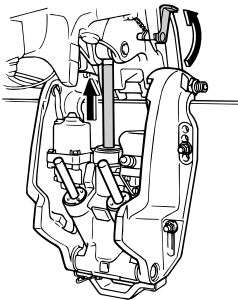

ZMU02635

7. Activate the trim-up switch until the tilt rod is fully extended. Unlock the tilt support lever.
8. Tilt the outboard motor down. Check that the tilt rod and trim rods operate smoothly.

## NOTE:

Consult your Yamaha dealer if any operation is abnormal.

EMU29171

## Checking propeller

EWM00321

### WARNING

You could be seriously injured if the engine accidentally starts when you are near the propeller.

- Before inspecting, removing, or installing the propeller, remove the spark plug caps from the spark plugs. Also, place the shift control in neutral, turn the main switch to “OFF” (off) and remove the key, and remove the lanyard from the engine stop switch. Turn off the battery cut-off switch if your boat has one.
- Do not use your hand to hold the propeller when loosening or tightening the propeller nut. Put a wood block between the anti-cavitation plate and the propeller to prevent the propeller from turning.

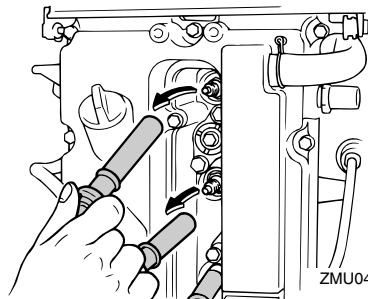

ZMU04262

# Maintenance

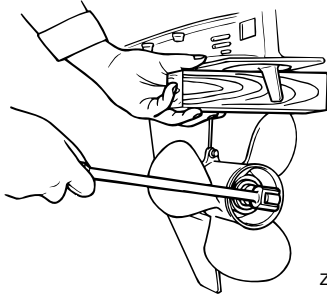

ZMU01897

## Checkpoints

- Check each of the propeller blades for wear, erosion from cavitation or ventilation, or other damage.
- Check the propeller shaft for damage.
- Check the splines / shear pin for wear or damage.
- Check for fish line tangled around the propeller shaft.

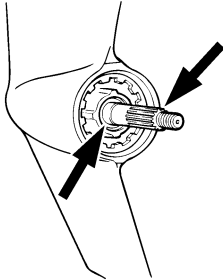

ZMU01803

- Check the propeller shaft oil seal for damage.

## NOTE:

If the shear pin equipped: it is designed to break if the propeller hits a hard underwater obstacle to help protect the propeller and drive mechanism. The propeller will then spin freely on the shaft. If this happens, the shear pin must be replaced.

EMU29193

## Removing the propeller

1. Straighten the cotter pin and pull it out using a pair of pliers.
2. Remove the propeller nut, washer, and spacer (if equipped).

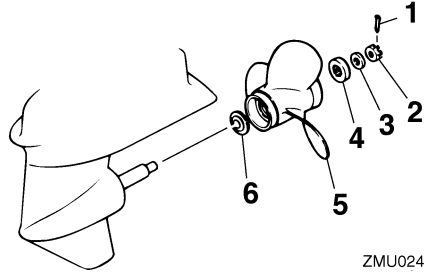

ZMU02416

1. Cotter pin
2. Propeller nut
3. Washer
4. Spacer
5. Propeller
6. Thrust washer

3. Remove the propeller and thrust washer.

EMU29240

## Installing the propeller

EWM00770



On counter rotation models, be sure to use a propeller intended for counter-clockwise rotation. These propellers are identified with the letter "L" after the size indication on the propeller. Otherwise the boat could move in the opposite direction from that expected.

ECM00340



- Be sure to install the thrust washer before installing the propeller, otherwise the lower case and propeller boss



# Maintenance

could be damaged.

- Be sure to use a new cotter pin and bend the ends over securely. Otherwise the propeller could come off during operation and be lost.

1. Apply Yamaha marine grease or a corrosion resistant grease to the propeller shaft.
2. Install the thrust washer and propeller on the propeller shaft.
3. Install the spacer and washer. Tighten the propeller nut to the specified torque.
4. Align the propeller nut with the propeller shaft hole. Insert a new cotter pin in the hole and bend the cotter pin ends.

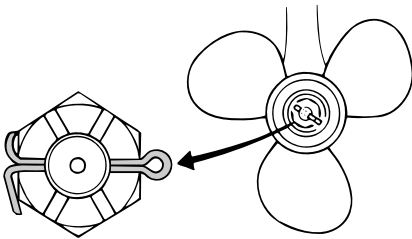

ZMU02063

## NOTE:

If the propeller nut does not align with the propeller shaft hole after tightening to the specified torque, tighten the nut further to align it with the hole.

EMU29280

## Changing gear oil

EWM00800

### WARNING

- Be sure the outboard motor is securely fastened to the transom or a stable stand. You could be severely injured if the outboard motor falls on you.
- Never get under the lower unit while it is tilted, even when the tilt support lever

or knob is locked. Severe injury could occur if the outboard motor accidentally falls.

1. Tilt the outboard motor so that the gear oil drain screw is at the lowest point possible.
2. Place a suitable container under the gear case.
3. Remove the gear oil drain screw.

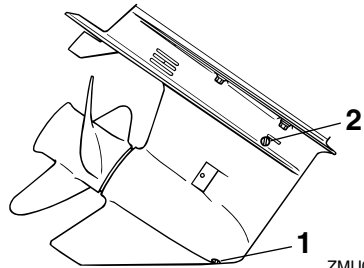

ZMU03273

1. Gear oil drain screw
2. Oil level plug

## NOTE:

If the magnetic gear oil drain screw equipped: remove all metal particles from the screw before installing it.

4. Remove the oil level plug to allow the oil to drain completely.

ECM00710

### CAUTION:

Inspect the used oil after it has been drained. If the oil is milky, water is getting into the gear case which can cause gear damage. Consult a Yamaha dealer for repair of the lower unit seals.

## NOTE:

For disposal of used oil consult your Yamaha dealer.

5. With the outboard motor in a vertical po-

# Maintenance

sition, and using a flexible or pressurized filling device, inject the gear oil into the gear oil drain screw hole.

Recommended gear oil:

Hypoid gear oil SAE#90

Gear oil quantity:

F115AET 760.0 cm<sup>3</sup> (25.70 US oz)  
(26.81 Imp.oz)

FL115AET 715.0 cm<sup>3</sup> (24.18 US oz)  
(25.17 Imp.oz)

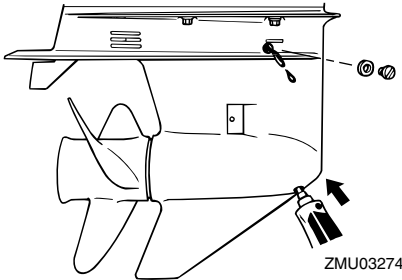

- When the oil begins to flow out of the oil level plug hole, insert and tighten the oil level plug.
- Insert and tighten the gear oil drain screw.

EMU29312

## Inspecting and replacing anode(s)

Yamaha outboard motors are protected from corrosion by sacrificial anodes. Inspect the external anodes periodically. Remove scales from the surfaces of the anodes. Consult a Yamaha dealer for replacement of external anodes.

ECM00720

### **CAUTION:**

**Do not paint anodes, as this would render them ineffective.**

### **NOTE:**

Inspect ground leads attached to external

anodes on equipped models. Consult a Yamaha dealer for inspection and replacement of internal anodes attached to the power unit.

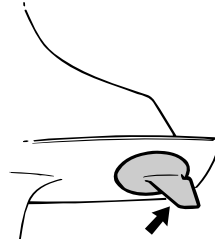

ZMU01901

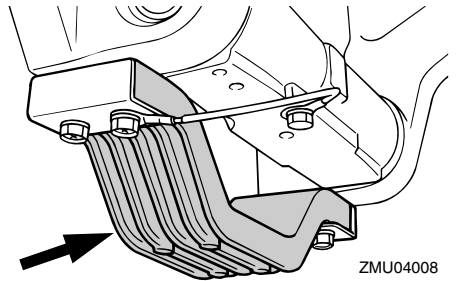

ZMU04008

EMU29320

## Checking battery (for electric start models)

EWM00330

### **WARNING**

**Battery electrolytic fluid is dangerous; it contains sulfuric acid and therefore is poisonous and highly caustic.**

**Always follow these preventive measures:**

- Avoid bodily contact with electrolytic fluid as it can cause severe burns or permanent eye injury.
- Wear protective eye gear when han-

dling or working near batteries.

**Antidote (EXTERNAL):**

- **SKIN** - Flush with water.
- **EYES** - Flush with water for 15 minutes and get immediate medical attention.

**Antidote (INTERNAL):**

- Drink large quantities of water or milk followed by milk of magnesia, beaten egg, or vegetable oil. Get immediate medical attention.

Batteries also generate explosive hydrogen gas; therefore, you should always follow these preventive measures:

- Charge batteries in a well-ventilated area.
- Keep batteries away from fire, sparks, or open flames (for example: welding equipment, lighted cigarettes, and so on.)
- **DO NOT SMOKE** when charging or handling batteries.

**KEEP BATTERIES AND ELECTROLYTIC FLUID OUT OF REACH OF CHILDREN.**

ECM00360

**CAUTION:**

- A poorly maintained battery will quickly deteriorate.
- Ordinary tap water contains minerals harmful to a battery, and should not be used for topping up.

1. Check the electrolyte level at least once a month. Fill to the manufacturer's recommended level when necessary. Top up only with distilled water (or pure de-ionized water suitable to use in batteries).

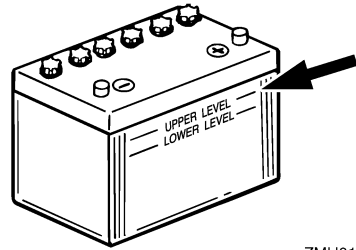

ZMU01810

2. Always keep the battery in a good state of charge. Installing a voltmeter will help you monitor your battery. If you will not use the boat for a month or more, remove the battery from the boat and store it in a cool, dark place. Completely recharge the battery before using it.
3. If the battery will be stored for longer than a month, check the specific gravity of the fluid at least once a month and recharge the battery when it is low.

**NOTE:**

Consult a Yamaha dealer when charging or re-charging batteries.

EMU29331

**Connecting the battery**

EWM00570

**WARNING**

Mount the battery holder securely in a dry, well-ventilated, vibration-free location in the boat. Install a fully charged battery in the holder.

ECM01121

**CAUTION:**

- Make sure the main switch (on applicable models) is "OFF" (off) before working on the battery.
- Reversal of the battery cables will damage the electrical parts.
- Connect the red battery cable first

# Maintenance

when installing the battery and disconnect the black battery cable first when removing it. Otherwise, the electrical parts can be damaged.

- The electrical contacts of the battery and cables must be clean and properly connected, or the battery will not start the engine.

Connect the red battery cable to the POSITIVE (+) terminal first. Then connect the black battery cable to the NEGATIVE (-) terminal.

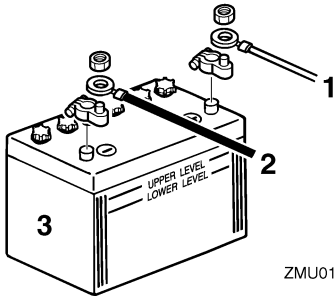

ZMU01811

1. Red cable
2. Black cable
3. Battery

EMU29370

## Disconnecting the battery

Disconnect the BLACK cable from the NEGATIVE (-) terminal first. Then disconnect the RED cable from the POSITIVE (+) terminal.

EMU29390

## Checking top cowling

Check the fitting of the top cowling by pushing it with both hands. If it is loose have it repaired by your Yamaha dealer.

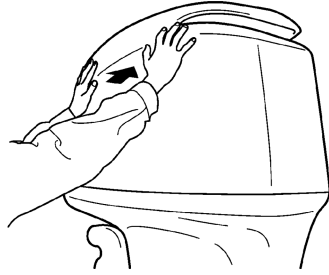

ZMU01812

EMU29400

## Coating the boat bottom

A clean hull improves boat performance. The boat bottom should be kept as clean of marine growth as possible. If necessary, the boat bottom can be coated with an anti-fouling paint approved for your area to inhibit marine growth.

Do not use anti-fouling paint which includes copper or graphite. These paints can cause more rapid engine corrosion.

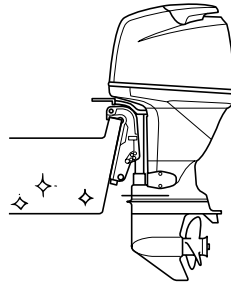

ZMU04246

EMU29422

## Troubleshooting

A problem in the fuel, compression, or ignition systems can cause poor starting, loss of power, or other problems. This section describes basic checks and possible remedies, and covers all Yamaha outboard motors. Therefore some items may not apply to your model.

If your outboard motor requires repair, bring it to your Yamaha dealer.

If the engine trouble warning indicator is flashing, consult your Yamaha dealer.

### **Starter will not operate.**

Q. Is battery capacity weak or low?

A. Check battery condition. Use battery of recommended capacity.

Q. Are battery connections loose or corroded?

A. Tighten battery cables and clean battery terminals.

Q. Is fuse for electric start relay or electric circuit blown?

A. Check for cause of electric overload and repair. Replace fuse with one of correct amperage.

Q. Are starter components faulty?

A. Have serviced by a Yamaha dealer.

Q. Is shift lever in gear?

A. Shift to neutral.

### **Engine will not start (starter operates).**

Q. Is fuel tank empty?

A. Fill tank with clean, fresh fuel.

Q. Is fuel contaminated or stale?

A. Fill tank with clean, fresh fuel.

Q. Is fuel filter clogged?

A. Clean or replace filter.

Q. Is starting procedure incorrect?

A. See page 25.

Q. Has fuel pump malfunctioned?

A. Have serviced by a Yamaha dealer.

Q. Are spark plug(s) fouled or of incorrect type?

A. Inspect spark plug(s). Clean or replace with recommended type.

Q. Are spark plug cap(s) fitted incorrectly?

A. Check and re-fit cap(s).

Q. Is ignition wiring damaged or poorly connected?

A. Check wires for wear or breaks. Tighten all loose connections. Replace worn or broken wires.

Q. Are ignition parts faulty?

A. Have serviced by a Yamaha dealer.

Q. Is engine stop switch lanyard not attached?

A. Attach lanyard.

Q. Are engine inner parts damaged?

A. Have serviced by a Yamaha dealer.

### **Engine idles irregularly or stalls.**

Q. Are spark plug(s) fouled or of incorrect type?

A. Inspect spark plug(s). Clean or replace with recommended type.

# Trouble Recovery

---

Q. Is fuel system obstructed?

A. Check for pinched or kinked fuel line or other obstructions in fuel system.

Q. Is fuel contaminated or stale?

A. Fill tank with clean, fresh fuel.

Q. Is fuel filter clogged?

A. Clean or replace filter.

Q. Have ignition parts failed?

A. Have serviced by a Yamaha dealer.

Q. Has warning system activated?

A. Find and correct cause of warning.

Q. Is spark plug gap incorrect?

A. Inspect and adjust as specified.

Q. Is ignition wiring damaged or poorly connected?

A. Check wires for wear or breaks. Tighten all loose connections. Replace worn or broken wires.

Q. Is specified engine oil not being used?

A. Check and replace oil as specified.

Q. Is thermostat faulty or clogged?

A. Have serviced by a Yamaha dealer.

Q. Are carburetor adjustments incorrect?

A. Have serviced by a Yamaha dealer.

Q. Is fuel pump damaged?

A. Have serviced by a Yamaha dealer.

Q. Is air vent screw on fuel tank closed?

A. Open air vent screw.

Q. Is choke knob pulled out?

A. Return to home position.

Q. Is motor angle too high?

A. Return to normal operating position.

Q. Is carburetor clogged?

A. Have serviced by a Yamaha dealer.

Q. Is fuel joint connection incorrect?

A. Connect correctly.

Q. Is throttle valve adjustment incorrect?

A. Have serviced by a Yamaha dealer.

Q. Is battery cable disconnected?

A. Connect securely.

## **Warning buzzer sounds or indicator lights.**

Q. Is cooling system clogged?

A. Check water intake for restriction.

Q. Is engine oil level low?

A. Fill oil tank with specified engine oil.

Q. Is heat range of spark plug incorrect?

A. Inspect spark plug and replace it with recommended type.

Q. Is specified engine oil not being used?

A. Check and replace oil with specified type.

Q. Is engine oil contaminated or deteriorated?

A. Replace oil with fresh, specified type.

Q. Is oil filter clogged?

A. Have serviced by a Yamaha dealer.

Q. Has oil feed/injection pump malfunctioned?

# Trouble Recovery

A. Have serviced by a Yamaha dealer.

Q. Is load on boat improperly distributed?

A. Distribute load to place boat on an even plane.

Q. Is water pump or thermostat faulty?

A. Have serviced by a Yamaha dealer.

Q. Is there excess water in fuel filter cup?

A. Drain filter cup.

## Engine power loss.

Q. Is propeller damaged?

A. Have propeller repaired or replaced.

Q. Is propeller pitch or diameter incorrect?

A. Install correct propeller to operate outboard at its recommended speed (r/min) range.

Q. Is trim angle incorrect?

A. Adjust trim angle to achieve most efficient operation.

Q. Is motor mounted at incorrect height on transom?

A. Have motor adjusted to proper transom height.

Q. Has warning system activated?

A. Find and correct cause of warning.

Q. Is boat bottom fouled with marine growth?

A. Clean boat bottom.

Q. Are spark plug(s) fouled or of incorrect type?

A. Inspect spark plug(s). Clean or replace with recommended type.

Q. Are weeds or other foreign matter tangled on gear housing?

A. Remove foreign matter and clean lower unit.

Q. Is fuel system obstructed?

A. Check for pinched or kinked fuel line or other obstructions in fuel system.

Q. Is fuel filter clogged?

A. Clean or replace filter.

Q. Is fuel contaminated or stale?

A. Fill tank with clean, fresh fuel.

Q. Is spark plug gap incorrect?

A. Inspect and adjust as specified.

Q. Is ignition wiring damaged or poorly connected?

A. Check wires for wear or breaks. Tighten all loose connections. Replace worn or broken wires.

Q. Have ignition parts failed?

A. Have serviced by a Yamaha dealer.

Q. Is specified engine oil not being used?

A. Check and replace oil with specified type.

Q. Is thermostat faulty or clogged?

A. Have serviced by a Yamaha dealer.

Q. Is air vent screw closed?

A. Open the air vent screw.

Q. Is fuel pump damaged?

A. Have serviced by a Yamaha dealer.

Q. Is fuel joint connection incorrect?

A. Connect correctly.

# Trouble Recovery

---

Q. Is heat range of spark plug incorrect?

A. Inspect spark plug and replace it with recommended type.

Q. Is high pressure fuel pump drive belt broken?

A. Have serviced by a Yamaha dealer.

Q. Is engine not responding properly to shift lever position?

A. Have serviced by a Yamaha dealer.

## Engine vibrates excessively.

Q. Is propeller damaged?

A. Have propeller repaired or replaced.

Q. Is propeller shaft damaged?

A. Have serviced by a Yamaha dealer.

Q. Are weeds or other foreign matter tangled on propeller?

A. Remove and clean propeller.

Q. Is motor mounting bolt loose?

A. Tighten bolt.

Q. Is steering pivot loose or damaged?

A. Tighten or have serviced by a Yamaha dealer.

EMU29431

## Temporary action in emergency

EMU29440

### Impact damage

EWM00870



The outboard motor can be seriously damaged by a collision while operating or trailering. Damage could make the out-

## board motor unsafe to operate.

If the outboard motor hits an object in the water, follow the procedure below.

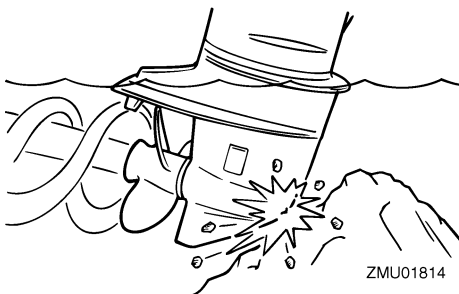

1. Stop the engine immediately.
2. Inspect the control system and all components for damage. Also inspect the boat for damage.
3. Whether damage is found or not, return to the nearest harbor slowly and carefully.
4. Have a Yamaha dealer inspect the outboard motor before operating it again.

EMU29450

## Running single engine

When using only engine in an emergency, be sure to keep the unused one tilted up and operate the other engine at low speed.

ECM00370

### CAUTION:

If the boat is operated with one engine in the water but not running, water may run into the exhaust pipe due to wave action, causing engine trouble.

### NOTE:

When you are maneuvering at low speed, such as near a dock, it is recommended that both engines be running with one in neutral gear if possible.



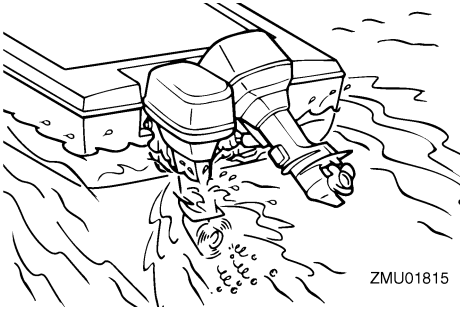

EMU29480

## Replacing fuse

If the fuse has blown on an electric start model, remove the electrical cover, open the fuse holder, and replace the fuse with a new one of the proper amperage.

EWM00630



**Be sure to use the specified fuse. An incorrect fuse or a piece of wire could allow excessive current flow. This could cause electric system damage and a fire hazard.**

## NOTE:

Consult your Yamaha dealer if the new fuse immediately blows again.

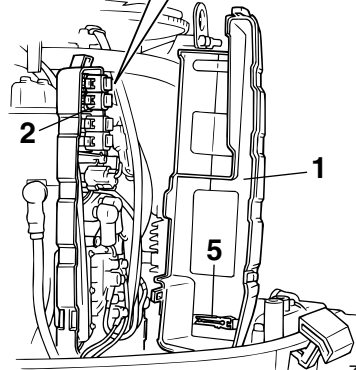
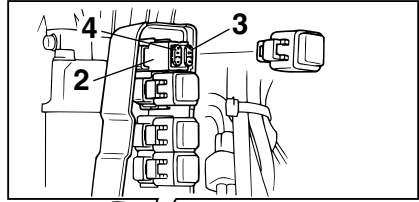

1. Electrical cover
2. Fuse holder
3. Fuse (20 A×2, 30 A×2)
4. Spare fuse (20 A, 30 A)
5. Fuse puller

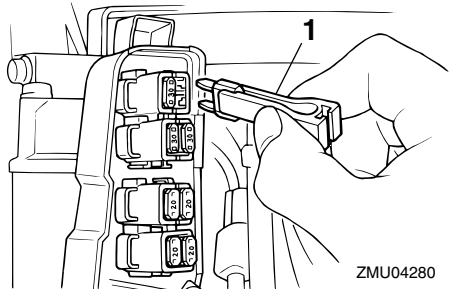

1. Fuse puller

EMU29520

## Power trim and tilt will not operate

If the engine cannot be tilted up or down with the power trim and tilt/ the power tilt because

# Trouble Recovery

of a discharged battery or a failure with the power trim and tilt unit/the power tilt, the engine can be tilted manually.

1. Loosen the manual valve screw by turning it counterclockwise until it stops.

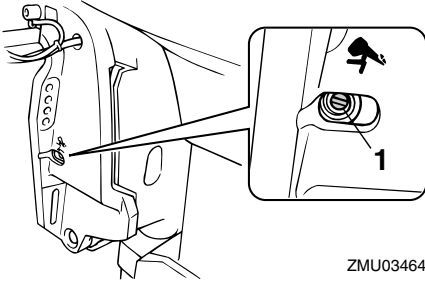

1. Manual valve screw
2. Put the engine in the desired position, then tighten the manual valve screw by turning it clockwise.

EMU29540

## Starter will not operate

If the starter mechanism does not operate (the engine cannot be cranked with the starter), the engine can be started manually with an emergency starter rope. However, the engine cannot be started manually if the battery voltage is low. If the battery is discharged to 9 volts or below, the electric fuel pump will not operate.

EWM01020

### **WARNING**

- Use this procedure only in an emergency and only to return to port for repairs.
- When the emergency starter rope is used to start the engine, the start-in-gear protection device does not operate. Make sure the remote control lever is in neutral. Otherwise the boat could unexpectedly start to move, which

could result in an accident.

- Attach the engine stop switch lanyard to a secure place on your clothing, or your arm or leg while operating.
- Do not attach the lanyard to clothing that could tear loose. Do not route the cord where it could become entangled, preventing it from functioning.
- Avoid accidentally pulling the lanyard during normal operation. Loss of engine power means the loss of most steering control. Also, without engine power, the boat could slow rapidly. This could cause people and objects in the boat to be thrown forward.
- Be sure no one is standing behind you when pulling the starter rope. It could whip behind you and injure someone.
- An unguarded, rotating flywheel is very dangerous. Keep loose clothing and other objects away when starting the engine. Use the emergency starter rope only as instructed. Do not touch the flywheel or other moving parts when the engine is running. Do not install the starter mechanism or top cowling after the engine is running.
- Do not touch the ignition coil, spark plug wire, spark plug cap, or other electrical components when starting or operating the motor. You could get an electrical shock.

EMU29642

## Emergency starting engine

1. Remove the top cowling.
2. Remove the two bolts holding the flywheel cover.

# Trouble Recovery

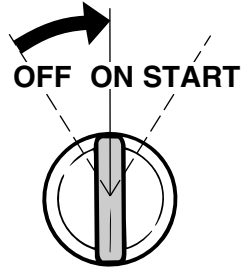
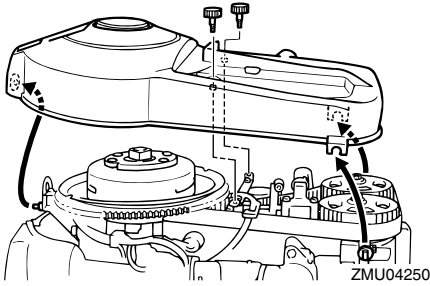

3. Lift up the rear of flywheel cover and pull it forward to remove it.
4. Prepare the engine for starting. For further information, see page 25. Be sure the engine is in neutral and that the engine stop switch lanyard lock plate is attached to the engine stop switch. The main switch must be "ON" (on).

5. Insert the knotted end of the emergency starter rope into the notch in the flywheel rotor and wind the rope around the flywheel clockwise.
6. Pull the rope slowly until resistance is felt.
7. Remove the rope from the flywheel temporarily.
8. Rewind the rope around the flywheel approximately 3/4 of a turn clockwise.
9. Give a strong pull straight out to crank and start the engine. Repeat if necessary.

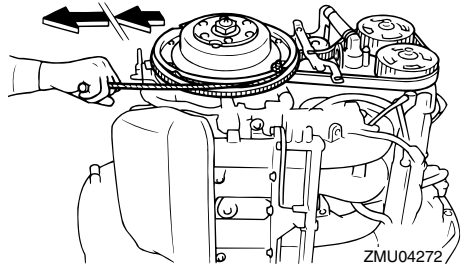
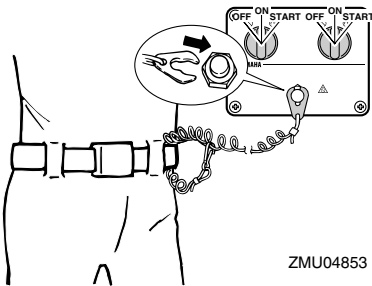
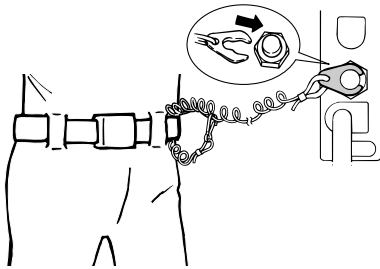

EMU29760

## Treatment of submerged motor

If the outboard motor is submerged, immediately take it to a Yamaha dealer. Otherwise some corrosion may begin almost immediately.

If you cannot immediately take the outboard motor to a Yamaha dealer, follow the proce-

# Trouble Recovery

---

cedure below in order to minimize engine damage.

EMU29790

## Procedure

1. Thoroughly wash away mud, salt, seaweed, and so on, with fresh water.
2. Remove the spark plugs and face the spark plug holes downward to allow any water, mud, or contaminants to drain.
3. Drain the fuel from the vapor separator, fuel filter, and fuel line.
4. Feed fogging oil or engine oil through the intake manifold and spark plug holes while cranking with the emergency starter rope.
5. Take the outboard motor to a Yamaha dealer as soon as possible.

ECM00400

## **CAUTION:**

**Do not attempt to run the outboard motor until it has been completely inspected.**





YAMAHA MOTOR CO., LTD.

Printed in Japan

March 2004-0.2 × 1 

Printed on recycled paper