

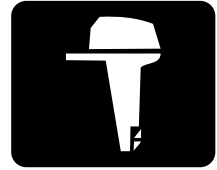

YAMAHA



**Z150P
LZ150P
Z175G
Z200N
LZ200N**

OWNER'S MANUAL

68F-28199-79-E0

CAUTION

USE UNLEADED STRAIGHT GASOLINE ONLY

- Gasoline containing lead can cause performance loss and engine damage.
- Do not use gasoline mixed with oil during the break-in period or any time afterwards.

**YAMALUBE 2 STROKE OUTBOARD OIL IS
RECOMMENDED**

ZMU01841

Read this owner's manual carefully before operating your outboard motor.

Important manual information

EMU25101

To the owner

Thank you for choosing a Yamaha outboard motor. This Owner's Manual contains information needed for proper operation, maintenance and care. A thorough understanding of these simple instructions will help you obtain maximum enjoyment from your new Yamaha. If you have any question about the operation or maintenance of your outboard motor, please consult a Yamaha dealer.

In this Owner's Manual particularly important information is distinguished in the following ways.



The Safety Alert Symbol means **ATTENTION! BECOME ALERT! YOUR SAFETY IS INVOLVED!**

EWM00780



WARNING

Failure to follow WARNING instructions could result in severe injury or death to the machine operator, a bystander, or a person inspecting or repairing the outboard motor.

ECM00700

CAUTION:

A CAUTION indicates special precautions that must be taken to avoid damage to the outboard motor.

NOTE:

A NOTE provides key information to make procedures easier or clearer.

Yamaha continually seeks advancements in product design and quality. Therefore, while this manual contains the most current product information available at the time of printing, there may be minor discrepancies between your machine and this manual. If there is any question concerning this manu-

al, please consult your Yamaha dealer.

To ensure long product life, Yamaha recommends that you use the product and perform the specified periodic inspections and maintenance by correctly following the instructions in the owner's manual. Note that if you do not follow these instructions, not only may the product break down, but the warranty will also be voided.

Some countries have laws or regulations restricting users from taking the product out of the country where it was purchased, and it may be impossible to register the product in the destination country. Additionally, the warranty may not apply in certain regions. When planning to take the product to another country, consult the dealer where the product was purchased for further information.

If the product was purchased used, please consult your closest dealer for customer re-registration, and to be eligible for the specified services.

NOTE:

The Z150PETO, LZ150PETO, Z175GETO, Z200NETO, LZ200NETO and the standard accessories are used as a base for the explanations and illustrations in this manual. Therefore some items may not apply to every model.

Important manual information

EMU25120

Z150P, LZ150P, Z175G, Z200N, LZ200N

OWNER'S MANUAL

©2006 by Yamaha Motor Co., Ltd.

1st Edition, March 2006

All rights reserved.

Any reprinting or unauthorized use

without the written permission of

Yamaha Motor Co., Ltd.

is expressly prohibited.

Printed in Japan

Table of contents

General information	1	Trip meter	18
Identification numbers record	1	Clock	18
Outboard motor serial number	1	Fuel gauge	18
Key number	1	Fuel warning indicator	19
EC label	1	Low battery voltage warning indicator	19
Safety information	2	Fuel management meter	19
Important labels	3	Fuel flow meter	20
Warning labels	3	Fuel consumption meter	20
Caution labels	4	Fuel economy	20
Fueling instructions	4	Twin-engine speed synchronizer	21
Gasoline	5	6Y8 Multifunction meters	22
Engine oil	5	Tachometer unit	22
Battery requirement	5	Speed & fuel meter unit	25
Battery specifications	5	Speedometer unit	26
Propeller selection	5	Fuel management meter	27
Start-in-gear protection	6	Warning system	28
Basic components	7	Overheat warning (twin engines)	28
Main components	7	Oil level warning and oil filter clogging warning	28
Remote control	8	Operation	30
Remote control lever	9	Installation	30
Neutral interlock trigger	9	Mounting the outboard motor	30
Neutral throttle lever	9	Breaking in engine	31
Free accelerator	10	Procedure for HPDI models	32
Throttle friction adjuster	10	Preoperation checks	32
Engine stop lanyard switch	11	Fuel	32
Main switch	11	Oil	33
Power trim and tilt switch on remote control or tiller handle	12	Controls	33
Power trim and tilt switch on bottom engine cowling	12	Engine	33
Power trim and tilt switches (twin binnacle type)	13	Operation after a long period of storage	33
Trim tab with anode	13	Filling fuel and engine oil	34
Tilt support lever for power trim and tilt or hydro tilt model	14	Filling fuel for models without a fuel joint	34
Top cowling lock levers	14	Filling oil for oil injection models	34
Flushing device	15	Oil level indicator operation	36
Water separator	15	Operating engine	37
Digital tachometer	15	Feeding fuel	37
Oil level indicator (digital type)	16	Starting engine	37
Overheat warning indicator (digital type)	16	Warming up engine	39
Speedometer (digital type)	16	Electric start and prime start models	39
Trim meter (digital type)	17	Shifting	39
Hour meter (digital type)	17	Forward (tiller handle and remote	

Table of contents

control models)	40	system.....	60
Reverse (automatic reverse lock and power trim and tilt models).....	40	Checking propeller	61
Stopping engine	41	Removing the propeller	62
Procedure	41	Installing the Propeller.....	62
Trimming outboard motor.....	41	Changing gear oil	63
Adjusting trim angle	42	Inspecting and replacing anode(s).....	64
Adjusting boat trim	43	Checking battery (for electric start models)	64
Tilting up and down	43	Connecting the Battery.....	65
Procedure for tilting up (power trim and tilt models / power tilt models)	44	Disconnecting the battery.....	66
Procedure for tilting down (power trim and tilt models / power tilt models)	45	Checking top cowling	66
Cruising in shallow water	46	Coating the boat bottom	67
Power trim and tilt models / power tilt models.....	46	Trouble Recovery.....	68
Cruising in other conditions.....	47	Troubleshooting	68
Maintenance.....	48	Temporary action in emergency ...	71
Specifications	48	Impact damage	71
Transporting and storing outboard motor	49	Running single engine.....	71
Storing outboard motor	50	Replacing fuse	72
Procedure	50	Power trim and tilt / power tilt will not operate	72
Lubrication (oil injection models).....	51	Water separator warning indicator blinks while cruising	73
Battery care.....	52	Starter will not operate	74
Flushing power unit.....	52	Emergency starting engine	75
Cleaning the outboard motor	53	Engine fails to operate	76
Checking painted surface of motor.....	53	Low oil level warning activates	76
Periodic maintenance.....	54	Treatment of submerged motor	77
Replacement parts	54	Procedure.....	77
Maintenance chart	55		
Maintenance chart (additional).....	56		
Greasing	57		
Cleaning and adjusting spark plug	57		
Checking fuel system	58		
Inspecting idling speed	59		
Checking water in engine oil tank ...	59		
Checking wiring and connectors	59		
Exhaust leakage	60		
Water leakage	60		
Checking power trim and tilt			

EMU25170

Identification numbers record

EMU25183

Outboard motor serial number

The outboard motor serial number is stamped on the label attached to the port side of the clamp bracket.

Record your outboard motor serial number in the spaces provided to assist you in ordering spare parts from your Yamaha dealer or for reference in case your outboard motor is stolen.

--	--	--	--

ZMU01693

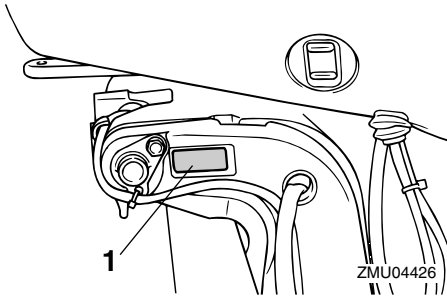

ZMU04426

1. Outboard motor serial number location

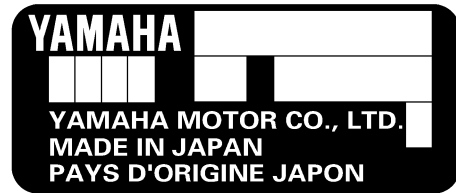

ZMU01692

EMU25190

Key number

If a main key switch is equipped with the motor, the key identification number is stamped on your key as shown in the illustration. Record this number in the space provided for reference in case you need a new key.

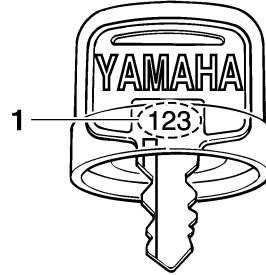

ZMU01694

1. Key number

EMU25202

EC label

Engines affixed with this label conform to certain portions of the European Parliament directive relating to machinery. Refer to the label and the EC Declaration of Conformity for more details.

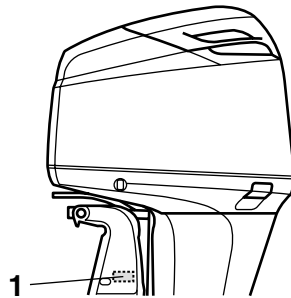

ZMU04725

1. EC label location

General information

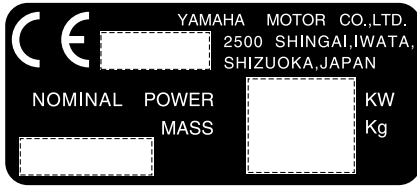

ZMU01696

EMU25371

Safety information

- Before mounting or operating the outboard motor, read this entire manual. Reading it should give you an understanding of the motor and its operation.
- Before operating the boat, read any owner's or operator's manuals supplied with it and all labels. Be sure you understand each item before operating.
- Do not overpower the boat with this outboard motor. Overpowering the boat could result in loss of control. The rated power of the outboard should be equal to or less than the rated horsepower capacity of the boat. If the rated horsepower capacity of the boat is unknown, consult the dealer or boat manufacturer.
- Do not modify the outboard. Modifications could make the motor unfit or unsafe to use.
- Incorrect propeller selection and incorrect use may not only cause engine damage, but also adversely affect fuel consumption. Consult your dealer for correct use.
- Never operate after drinking alcohol or taking drugs. About 50% of all boating fatalities involve intoxication.
- Have an approved personal flotation device (PFD) on board for every occupant. It is a good idea to wear a PFD whenever boating. At a minimum, children and non-swimmers should always wear PFDs, and everyone should wear PFDs when there are potentially hazardous boating conditions.
- Gasoline is highly flammable, and its vapors are flammable and explosive. Handle and store gasoline carefully. Make sure there are no gas fumes or leaking fuel before starting the engine.
- This product emits exhaust gases which contain carbon monoxide, a colorless, odorless gas which may cause brain damage or death when inhaled. Symptoms include nausea, dizziness, and drowsiness. Keep cockpit and cabin areas well ventilated. Avoid blocking exhaust outlets.
- Check throttle, shift, and steering for proper operation before starting the engine.
- Attach the engine stop switch lanyard to a secure place on your clothing, or your arm or leg while operating. If you accidentally leave the helm, the lanyard will pull from the switch, stopping the engine.
- Know the marine laws and regulations where you will be boating - and obey them.
- Stay informed about the weather. Check weather forecasts before boating. Avoid boating in hazardous weather.
- Tell someone where you are going: leave a Float Plan with a responsible person. Be sure to cancel the Float Plan when you return.
- Use common sense and good judgment when boating. Know your abilities, and be sure you understand how your boat handles under the different boating conditions you may encounter. Operate within your limits, and the limits of your boat. Always operate at safe speeds, and keep a careful

General information

watch for obstacles and other traffic.

- Always watch carefully for swimmers during the engine operation.
- Stay away from swimming areas.
- When a swimmer is in the water near you shift into neutral and shut off the engine.
- Do not illegally discard empty containers used to replace or replenish oil. For the correct processing of empty containers, consult the dealer where you purchased the oil.
- When replacing oils used to lubricate the product (engine or gear oil), be sure to wipe away any spilt oil. Never pour oil without using a funnel or similar device. If necessary, verify the necessary replacement procedure with the dealer.
- Never illegally discard (dump) the product. Yamaha recommends consulting the dealer on discarding the product.

EMU25382

Important labels

EMU25395

Warning labels

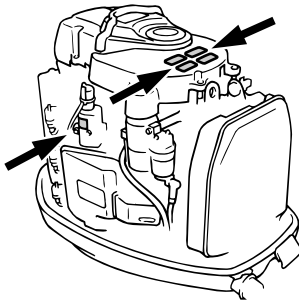

ZMU04727

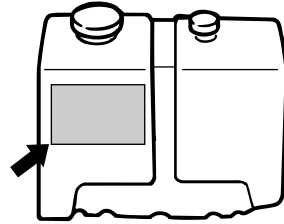

ZMU01948

EMU25401

Label

EWM01260

WARNING

- Be sure shift control is in neutral before starting engine. (except 2HP)
- Do not touch or remove electrical parts when starting or during operation.
- Keep hands, hair, and clothes away from flywheel and other rotating parts while engine is running.

EMU25413

Label (counter rotation models)

EWM01281

WARNING

Use only a counterclockwise rotation propeller with this engine. Counterclockwise propellers are marked with a letter "L" after the size indication. The wrong type of propeller could cause the boat to go in an unexpected direction, which could lead to an accident.

EMU25451

Label

ENGINE OIL ONLY

- Pour the engine oil into this oil tank, not gasoline.

RECOMMENDED OIL:

YAMALUBE 2 STROKE OUTBOARD OIL or

General information

an equivalent TC-W3 certified outboard oil.

EWM01270

WARNING

Do not add gasoline to the oil tank. Fire explosion could result.

EMU30471

Label

EWM01411

WARNING

Hot surface under this cover during and after operation. To avoid burns, do not touch finned resistor with bare hands.

EMU25465

Caution labels

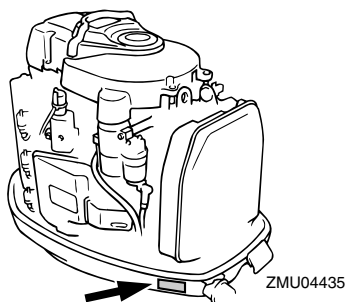

EMU30430

Label

ECM01440

CAUTION:

USE UNLEADED STRAIGHT GASOLINE ONLY

- Gasoline containing lead can cause performance loss and engine damage.
- Do not use gasoline mixed with oil (pre-mix).
- Use **YAMALUBE 2-stroke outboard oil** or another 2-stroke engine oil with a NMMA-certified TC-W3 rate.

Refer to Owner's manual.

EMU25540

Fueling instructions

EWM00010

WARNING

GASOLINE AND ITS VAPORS ARE HIGHLY FLAMMABLE AND EXPLOSIVE!

- Do not smoke when refueling, and keep away from sparks, flames, or other sources of ignition.
 - Stop engine before refueling.
 - Refuel in a well-ventilated area. Refuel portable fuel tanks off the boat.
 - Take care not to spill gasoline. If gasoline spills, wipe it up immediately with dry rags.
 - Do not overfill the fuel tank.
 - Tighten the filler cap securely after refueling.
 - If you should swallow some gasoline, inhale a lot of gasoline vapor, or get gasoline in your eyes, get immediate medical attention.
 - If any gasoline spills onto your skin, immediately wash with soap and water. Change clothing if gasoline spills on it.
 - Touch the fuel nozzle to the filler opening or funnel to help prevent electrostatic sparks.
-

ECM00010

CAUTION:

Use only new clean gasoline which has been stored in clean containers and is not contaminated with water or foreign matter.

General information

EMU25580

Gasoline

Recommended gasoline:
Regular unleaded gasoline with a minimum octane rating of 90 (Research Octane Number).

If knocking or pinging occurs, use a different brand of gasoline or premium unleaded fuel.

EMU25670

Engine oil

Yamalube 2 stroke outboard oil is strongly recommended for your Yamaha outboard motor. If Yamalube 2 stroke outboard oil is not available, a 2 stroke NMMA-certified TC-W3 oil of equivalent quality must be used.

Recommended engine oil:
YAMALUBE 2 STROKE OUTBOARD OIL

ECM01160

CAUTION:

Serious damage could result from use of a lesser quality oil.

EMU25700

Battery requirement

ECM01060

CAUTION:

Do not use a battery that does not meet the specified capacity. If a battery which does not meet specifications is used, the electric system could perform poorly or be overloaded, causing electric system damage.

For electric start models, choose a battery which meets the following specifications.

EMU25720

Battery specifications

Minimum cold cranking amps (CCA/EN):
711.0 A
Minimum rated capacity (20HR/IEC):
100.0 Ah

NOTE:

The engine cannot be started if battery voltage is too low.

EMU25742

Propeller selection

The performance of your outboard motor will be critically affected by your choice of propeller, as an incorrect choice could adversely affect performance and could also seriously damage the motor. Engine speed depends on the propeller size and boat load. If engine speed is too high or too low for good engine performance, this will have an adverse effect on the engine.

Yamaha outboard motors are fitted with propellers chosen to perform well over a range of applications, but there may be uses where a propeller with a different pitch would be more appropriate. For a greater operating load, a smaller-pitch propeller is more suitable as it enables the correct engine speed to be maintained. Conversely, a larger-pitch propeller is more suitable for a smaller operating load.

Yamaha dealers stock a range of propellers, and can advise you and install a propeller on your outboard that is best suited to your application.

General information

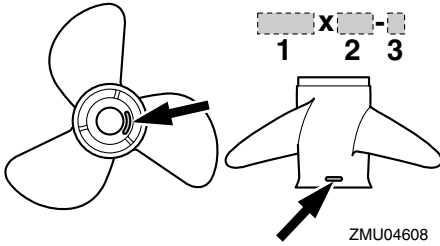

1. Propeller diameter in inches
2. Propeller pitch in inches
3. Type of propeller (propeller mark)

NOTE: _____

Select a propeller which will allow the engine to reach the middle or upper half of the operating range at full throttle with the maximum boat load. If operating conditions such as light boat loads then allow the engine r/min to rise above the maximum recommended range, reduce the throttle setting to maintain the engine in the proper operating range.

For instructions on propeller removal and installation, see page 61.

EMU25760

Start-in-gear protection

Yamaha outboard motors affixed with the pictured label or Yamaha-approved remote control units are equipped with start-in-gear protection device(s). This feature permits the engine to be started only when it is in neutral. Always select neutral before starting the engine.

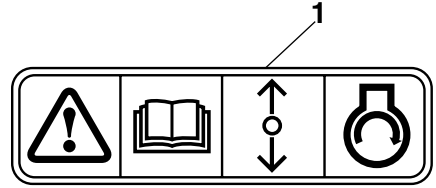

ZMU01713

1. Start-in-gear protection label

Basic components

EMU25799

Main components

NOTE:

* May not be exactly as shown; also may not be included as standard equipment on all models.

Z150P, LZ150P, Z175G, Z200N, LZ200N

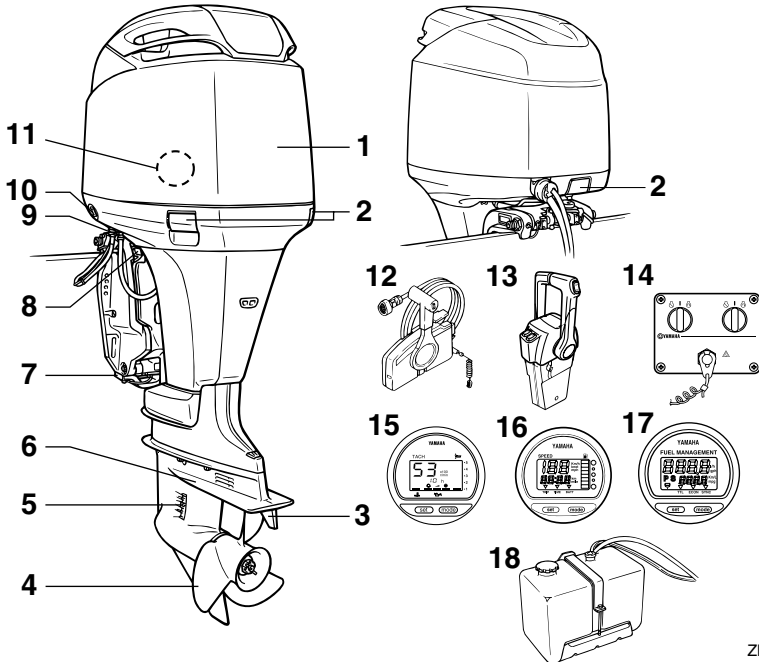

ZMU04714

1. Top cowling
2. Top cowling lock lever(s)
3. Trim tab (anode)
4. Propeller
5. Cooling water inlet
6. Anti-cavitation plate
7. Anode
8. Tilt support lever
9. Flushing device
10. Power trim and tilt switch
11. Water separator
12. Remote control box (side mount type)*
13. Remote control box (binnacle mount type)*
14. Switch panel (for use with binnacle type)*
15. Digital tachometer*
16. Digital speedometer*
17. Fuel management meter*
18. Remote oil tank

Basic components

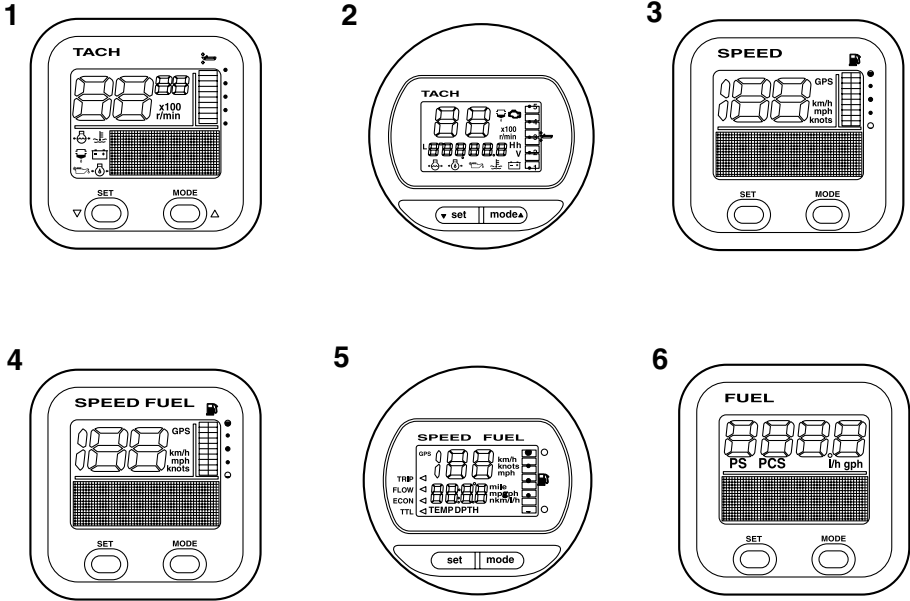

ZMU05429

1. Tachometer unit (Square type)*
2. Tachometer unit (Round type)*
3. Speedometer unit (Square type)*
4. Speed & fuel meter unit (Square type)*
5. Speed & fuel meter unit (Round type)*
6. Fuel management meter (Square type)*

EMU26180

Remote control

The remote control lever actuates both the shifter and the throttle. The electrical switches are mounted on the remote control box.

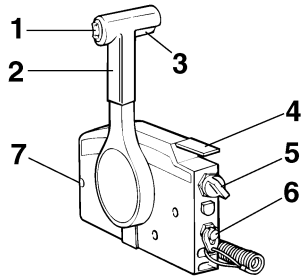

ZMU01723

1. Power trim and tilt switch
2. Remote control lever
3. Neutral interlock trigger
4. Neutral throttle lever
5. Main switch / choke switch
6. Engine stop lanyard switch
7. Throttle friction adjuster

Basic components

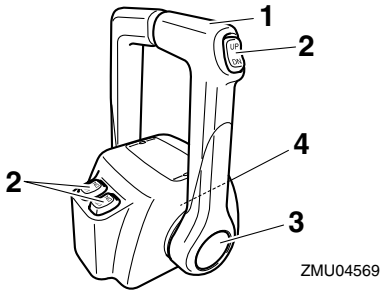

1. Remote control lever
2. Power trim and tilt switch
3. Free accelerator
4. Throttle friction adjuster

EMU26190

Remote control lever

Moving the lever forward from the neutral position engages forward gear. Pulling the lever back from neutral engages reverse. The engine will continue to run at idle until the lever is moved about 35° (a detent can be felt). Moving the lever farther opens the throttle, and the engine will begin to accelerate.

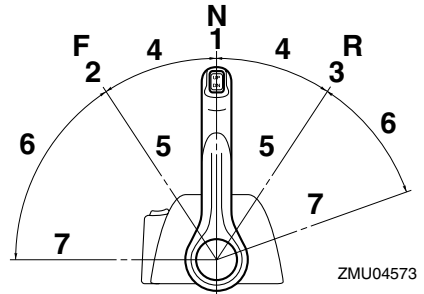

1. Neutral "N"
2. Forward "F"
3. Reverse "R"
4. Shift
5. Fully closed
6. Throttle
7. Fully open

EMU26201

Neutral interlock trigger

To shift out of neutral, first pull the neutral interlock trigger up.

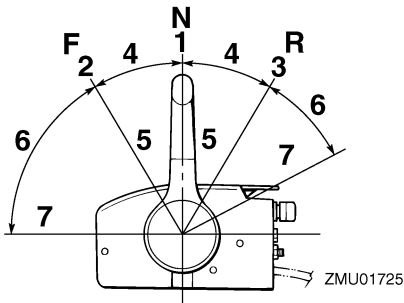

1. Neutral "N"
2. Forward "F"
3. Reverse "R"
4. Shift
5. Fully closed
6. Throttle
7. Fully open

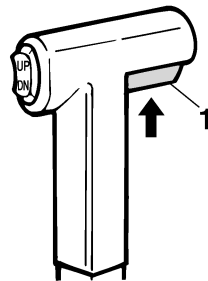

1. Neutral interlock trigger

EMU26211

Neutral throttle lever

To open the throttle without shifting into either forward or reverse, put the remote control lever in the neutral position and lift the neutral throttle lever.

Basic components

NOTE:

The neutral throttle lever will operate only when the remote control lever is in neutral. The remote control lever will operate only when the neutral throttle lever is in the closed position.

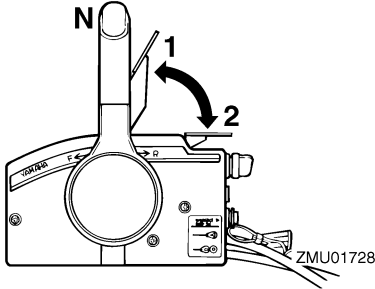

1. Fully open
2. Fully closed

EMU26232

Free accelerator

To open the throttle without shifting into either forward or reverse, push the free accelerator button and move the remote control lever.

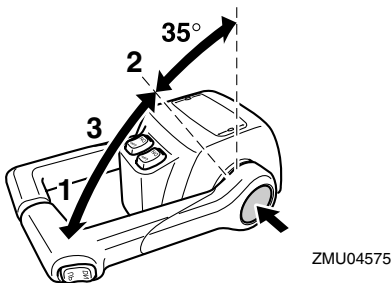

1. Fully open
2. Fully closed
3. Free accelerator

NOTE:

- The free accelerator button can only be

used when the remote control lever is in the neutral position.

- After the button is pushed, the throttle begins to open after the remote control lever is moved at least 35°.
- After using the free accelerator, return the remote control lever to the neutral position. The free accelerator button will return automatically to its set position. The remote control will then engage forward and reverse normally.

EMU25971

Throttle friction adjuster

A friction device provides adjustable resistance to movement of the throttle grip or the remote control lever, and can be set according to operator preference.

To increase resistance, turn the adjuster clockwise. To decrease resistance, turn the adjuster counterclockwise.

EWM00031

WARNING

Do not overtighten the friction adjuster. If there is too much resistance, it could be difficult to move the remote control lever or throttle grip, which could result in an accident.

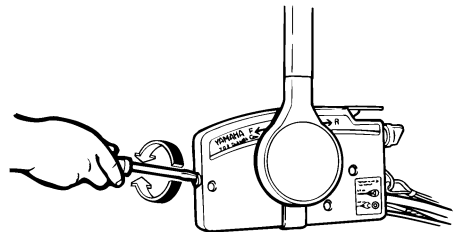

ZMU01714

Basic components

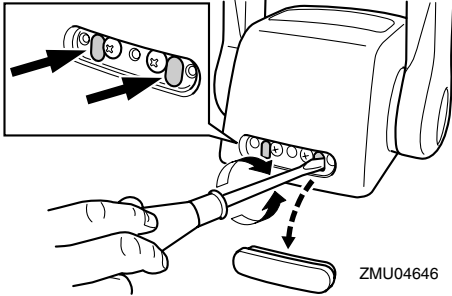

When constant speed is desired, tighten the adjuster to maintain the desired throttle setting.

EMU25990

Engine stop lanyard switch

The lock plate must be attached to the engine stop switch for the engine to run. The lanyard should be attached to a secure place on the operator's clothing, or arm or leg. Should the operator fall overboard or leave the helm, the lanyard will pull out the lock plate, stopping ignition to the engine. This will prevent the boat from running away under power.

EWM00120

WARNING

- **Attach the engine stop switch lanyard to a secure place on your clothing, or your arm or leg while operating.**
- **Do not attach the lanyard to clothing that could tear loose. Do not route the lanyard where it could become entangled, preventing it from functioning.**
- **Avoid accidentally pulling the lanyard during normal operation. Loss of engine power means the loss of most steering control. Also, without engine power, the boat could slow rapidly. This could cause people and objects in the boat to be thrown forward.**

NOTE:

The engine cannot be started with the lock plate removed.

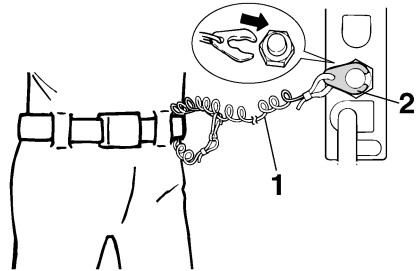

ZMU01716

1. Lanyard
2. Lock plate

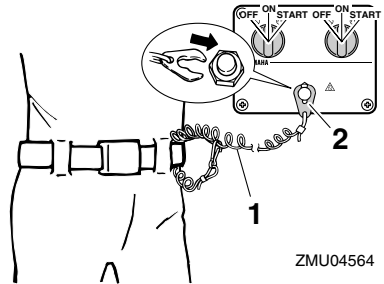

ZMU04564

1. Lanyard
2. Lock plate

EMU26090

Main switch

The main switch controls the ignition system; its operation is described below.

● "OFF" (off)

With the main switch in the "OFF" (off) position, the electrical circuits are off, and the key can be removed.

● "ON" (on)

With the main switch in the "ON" (on) position, the electrical circuits are on, and the key cannot be removed.

Basic components

● “START” (start)

With the main switch in the “START” (start) position, the starter motor turns to start the engine. When the key is released, it returns automatically to the “ON” (on) position.

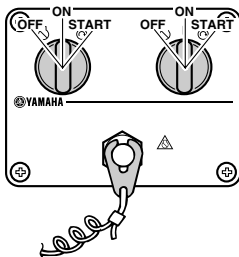
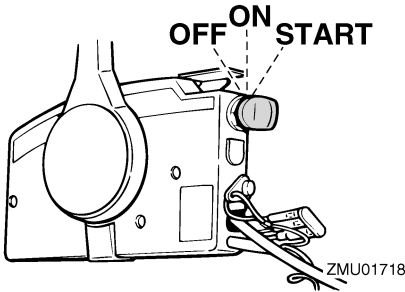

EMU26141

Power trim and tilt switch on remote control or tiller handle

The power trim and tilt system adjusts the outboard motor angle in relation to the transom. Pressing the switch “UP” (up) trims the outboard motor up, then tilts it up. Pressing the switch “DN” (down) tilts the outboard motor down and trims it down. When the switch is released, the outboard motor will stop in its current position.

NOTE:

For instructions on using the power trim and tilt switch, see pages 41 and 43.

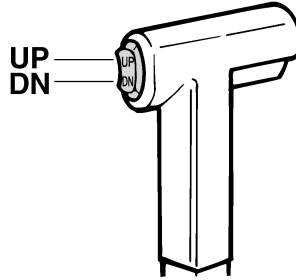

EMU26151

Power trim and tilt switch on bottom engine cowling

The power trim and tilt switch is located on the side of the bottom engine cowling. Pressing the switch “UP” (up) trims the outboard motor up, then tilts it up. Pressing the switch “DN” (down) tilts the outboard motor down and trims it down. When the switch is released, the outboard motor will stop in its current position.

EWMO1030



WARNING

Use the power trim and tilt switch located on the bottom engine cowling only when the boat is at a complete stop with the engine off. Attempting to use this switch while the boat is moving could increase the risk of falling overboard and could distract the operator, increasing the risk of collision with another boat or an obstacle.

Basic components

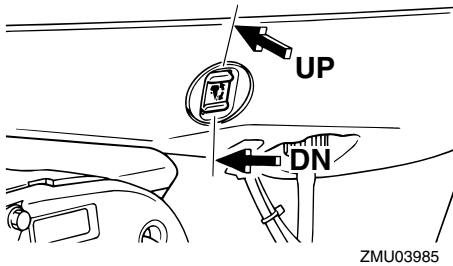

NOTE:

For instructions on using the power trim and tilt switch, see page 43.

EMU26241

Power trim and tilt switches (twin binnacle type)

The power trim and tilt system adjusts the outboard motor angle in relation to the transom. Pushing the switch “UP” (up) trims the outboard motor up, then tilts it up. Pressing the switch “DN” (down) tilts the outboard motor down and trims it down. When the switch is released, the outboard motor will stop in its current position.

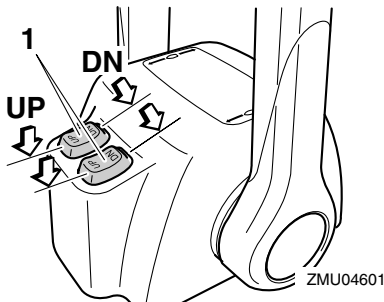

1. Power trim and tilt switch

NOTE:

- On the dual engine control, the switch on the remote control grip controls both outboard motors at the same time.

- For instructions on using the power trim and tilt switches, see pages 41 and 43.

EMU26241

Trim tab with anode

The trim tab should be adjusted so that the steering control can be turned to either the right or left by applying the same amount of force.

EWM00840

WARNING

An improperly adjusted trim tab could cause difficult steering. Always test run after the trim tab has been installed or replaced to be sure steering is correct. Be sure you have tightened the bolt after adjusting the trim tab.

If the boat tends to veer the left (port side), turn the trim tab rear end to the port side “A” in the figure. If the boat tends to veer the right (starboard side), turn the trim tab end to the starboard side “B” in the figure.

ECM00840

CAUTION:

The trim tab also serves as an anode to protect the engine from electrochemical corrosion. Never paint the trim tab as it will become ineffective as an anode.

Basic components

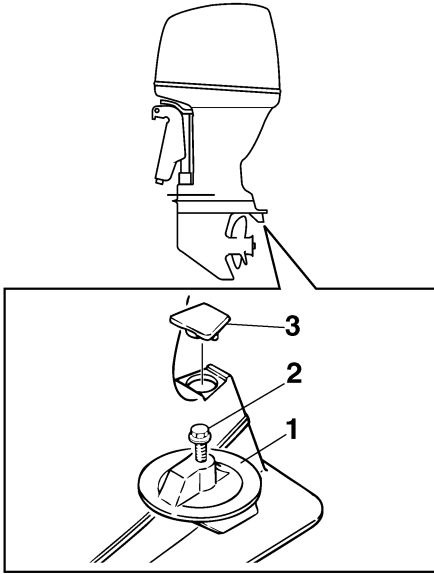

ZMU01730

1. Trim tab
2. Bolt
3. Cap

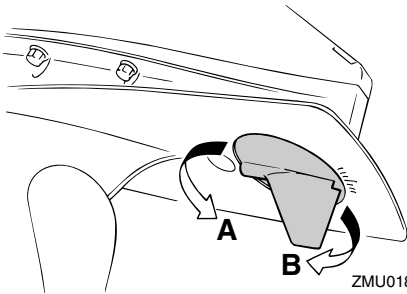

ZMU01863

EMU26340

Tilt support lever for power trim and tilt or hydro tilt model

To keep the outboard motor in the tilted up position, lock the tilt support lever to the clamp bracket.

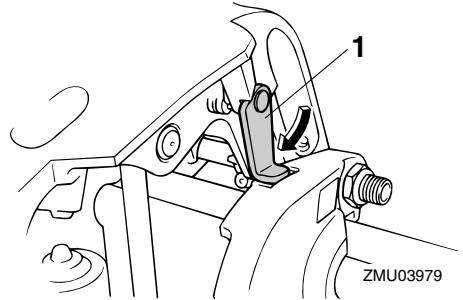

ZMU03979

1. Tilt support lever

EMU26391

Top cowling lock levers

To remove the outboard motor top cowling, pull up the front and rear lock levers. Then lift off the cowling. When the cowling, check to be sure it fits properly in the rubber seal. Then lock the cowling again by moving the levers downward.

ECM00550

CAUTION:

The air intake grille on the top cowling is not designed as a handle and could break if used as such.

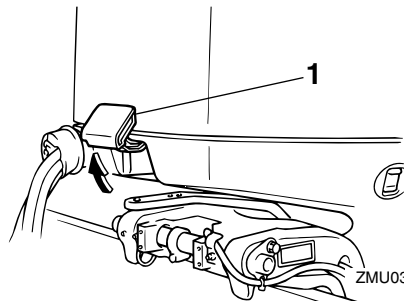

ZMU03986

1. Top cowling lock lever(s)

Basic components

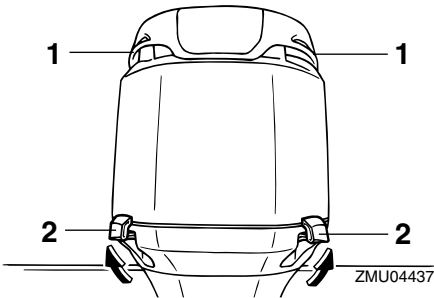

1. Air intake grille
2. Top cowling lock lever(s)

EMU26460

Flushing device

This device is used to clean the cooling water passages of the motor using a garden hose and tap water.

NOTE:

For details on usage, see page 52.

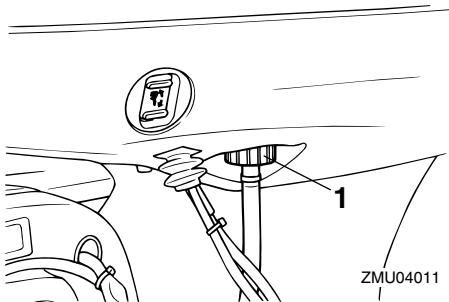

1. Flushing device

EMU31702

Water separator

This engine has a combination fuel filter/water separator and associated warning system. If water separated from the fuel exceeds a specific volume, the warning device will activate.

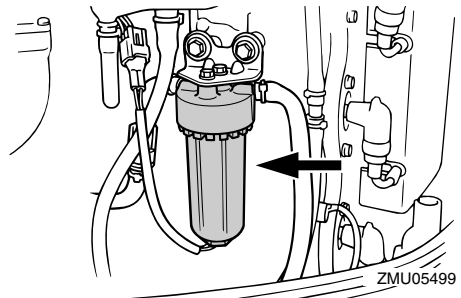

Activation of warning device

- The water separator warning indicator will blink.
- The buzzer will sound intermittently only when the gear shift is in neutral.
- If the warning system has activated, stop the engine and consult a Yamaha dealer immediately.

EMU26491

Digital tachometer

The tachometer shows the engine speed and has the following functions.

NOTE:

All segments of the display will light momentarily after the main switch is turned on and will return to normal thereafter.

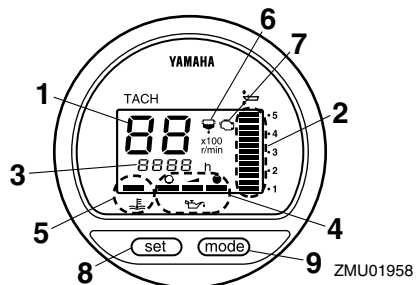

1. Tachometer
2. Trim meter
3. Hour meter
4. Oil level indicator

Basic components

5. Overheat warning indicator
6. Water separator warning indicator
7. Engine trouble warning indicator
8. Set button
9. Mode button

NOTE:

The water separator and engine trouble warning indicators only operate when the engine is equipped with the appropriate functions.

EMU26550

Oil level indicator (digital type)

This indicator shows the engine oil level. If the oil level falls below the lower limit, the warning indicator will start to blink. For further information, see page 28.

ECM00030

CAUTION:

Do not operate the engine without oil. Serious engine damage will occur.

page 28.

ECM00050

CAUTION:

Do not continue to run the engine if the overheat warning indicator is on. Serious engine damage will occur.

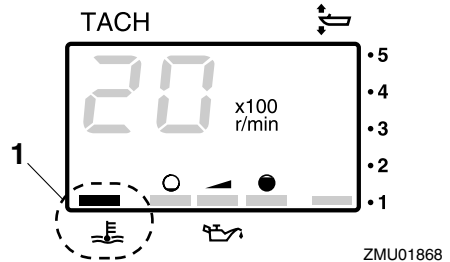

1. Overheat warning indicator

EMU26600

Speedometer (digital type)

This gauge shows the boat speed.

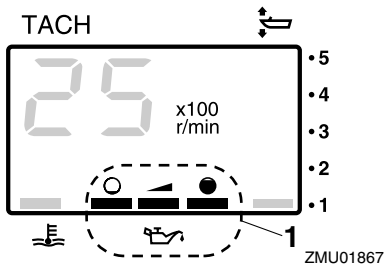

1. Oil level indicator

EMU26581

Overheat warning indicator (digital type)

If the engine temperature rises too high, the warning indicator will start to blink. For further information on reading the indicator, see

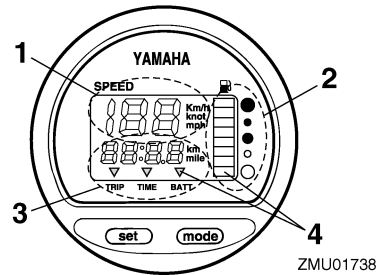

1. Speedometer
2. Fuel gauge
3. Trip meter/clock/voltmeter
4. Warning indicator(s)

NOTE:

After the main switch is first turned on, all segments of the display come on as a test. After a few seconds, the gauge will change to normal operation. Watch the gauge when

Basic components

turning on the main switch to make sure all segments come on.

NOTE:

The speedometer displays km/h, mph, or knots, according to operator preference. Select the desired unit of measurement by setting the selector switch on the back of the gauge. See the illustration for settings.

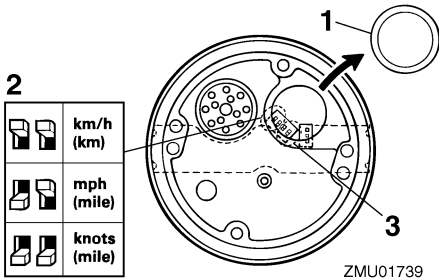

ZMU01739

1. Cap
2. Selector switch (for speed unit)
3. Selector switch (for fuel sensor)

EMU26620

Trim meter (digital type)

This meter shows the trim angle of your outboard motor.

NOTE:

- Memorize the trim angles that work best for your boat under different conditions. Adjust the trim angle to the desired using the power trim and tilt switch.
- If the trim angle of your motor exceeds the trim operating range, the top segment on the trim meter display will blink.

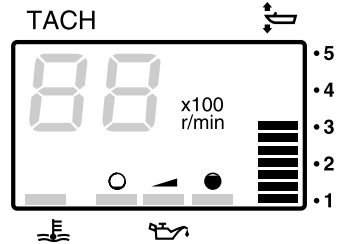

ZMU01869

EMU26650

Hour meter (digital type)

This meter shows the number of hours the engine has been run. It can be set to show the total number of hours or the number of hours for the current trip. The display can also be turned on and off.

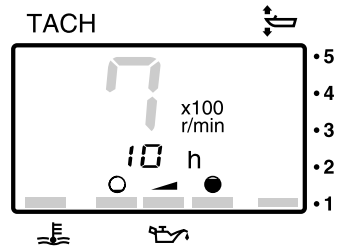

ZMU01870

- Changing the display format
- Pressing the "mode" (mode) button changes the display format in the following pattern:
 - Total hours → Trip hours → Display off
 - Resetting the trip hours
 - Simultaneously pressing the "set" (set) and "mode" (mode) buttons for more than 1 second while the trip hours are displayed resets the trip counter to 0 (zero).

NOTE:

The total number of hours the engine has been run cannot be reset.

Basic components

EMU26690

Trip meter

This gauge displays the distance the boat has traveled since the gauge was last reset. Press the “**mode**” (mode) button repeatedly until the indicator on the face of the gauge points to “**TRIP**” (trip). To reset the trip meter to zero, press the “**set**” (set) and “**mode**” (mode) buttons at the same time.

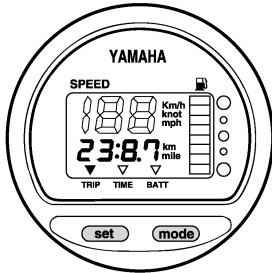

ZMU01743

NOTE:

- The trip distance is shown in kilometers or miles depending upon the unit of measurement selected for the speedometer.
- The trip distance is kept in memory by battery power. The stored data will be lost if the battery is disconnected.

EMU26700

Clock

Press the “**mode**” (mode) button repeatedly until the indicator on the face of the gauge points to “**TIME**” (time). To set the clock, be sure the gauge is in the “**TIME**” (time) mode. Press the “**set**” (set) button; the hour display will begin blinking. Press the “**mode**” (mode) button until the desired hour is displayed. Press the “**set**” (set) button again, the minute display will begin blinking. Press the “**mode**” (mode) button until the desired minute is displayed. Press the “**set**” (set) button again to start the clock.

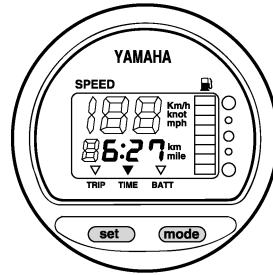

ZMU01744

NOTE:

The clock operates on battery power. Disconnecting the battery will stop the clock. Reset the clock after connecting the battery.

EMU26710

Fuel gauge

The fuel level is indicated by eight segments. When all segments are showing, the fuel tank is full.

ECM00860

CAUTION:

The Yamaha fuel tank sensor differs from conventional sensors. Incorrectly setting the selector switch on the gauge will give false readings. Consult your Yamaha dealer on how to correctly set the selector switch.

NOTE:

The fuel level reading can be affected by the position of the sensor in the fuel tank and the attitude of the boat in the water. Operation with bow-up trim or continuous turning can give false readings.

Basic components

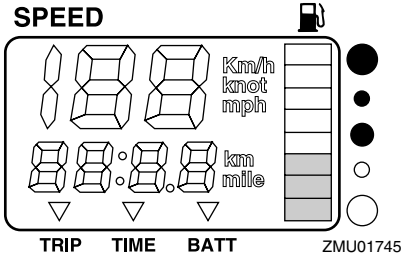

EMU26720

Fuel warning indicator

If the fuel level decreases to one segment, the fuel level warning segment will begin to blink.

ECM00880

CAUTION:

Do not continue to operate the engine with full throttle if a warning device has activated. Get back to the port within trolling engine speed.

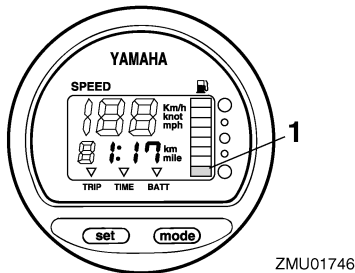

1. Fuel level warning segment

EMU26730

Low battery voltage warning indicator

If battery voltage drops, the display will automatically turn on and begin to blink.

ECM00870

CAUTION:

Get back to the port soon if a warning de-

vice has activated. For charging the battery, consult your Yamaha dealer.

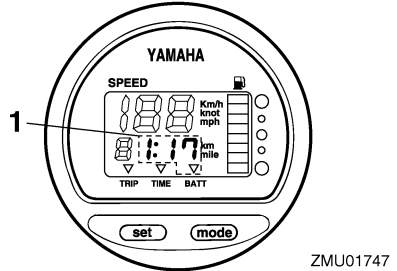

1. Low battery indicator

EMU26740

Fuel management meter

The fuel management meter shows the state of the fuel consumption while the engine is running.

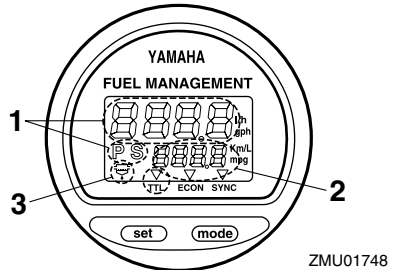

1. Fuel flow meter
2. Fuel consumption meter / Fuel economy meter / Twin engine speed synchronizer
3. Water separator warning indicator (operates only if the sensor has been installed)

NOTE:

After the main switch is first turned on, all segments of the display come on as a test. After a few seconds, the gauge will change to normal operation. Watch the gauge when turning on the main switch to make sure all

Basic components

segments come on.

EMU26750

Fuel flow meter

The fuel flow meter displays the amount of fuel flow over a one hour period, at the current rate of engine operation.

If twin engines are installed on your boat, the fuel flow meter displays the total fuel flow of both the port and starboard engines. It also displays “P S” (for port and starboard).

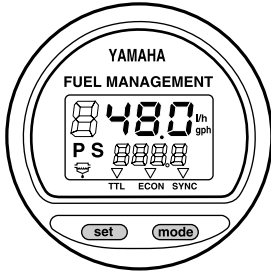

ZMU01749

Use the “set” (set) button to rotate the fuel flow display in the following order:

- Press the “set” (set) button once to display the fuel flow of the starboard engine. An “S” (for starboard) will also be displayed.
- Press the “set” (set) button a second time to display the fuel flow of the port engine. A “P” (for port) will also be displayed.
- Press the “set” (set) button a third time to return the display to the total fuel flow of both engines. “P S” (for port and starboard) will also be displayed to indicate both the port and starboard engines.

NOTE:

- The fuel flow meter displays gallons/hour or liters/hour according to operator preference. Select the desired unit of measurement by setting the selector switch on the back of the gauge during installation.

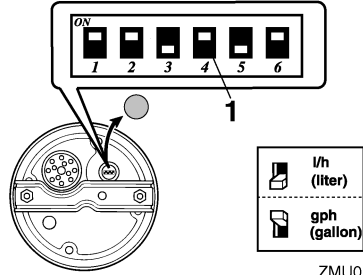

ZMU01750

1. Selector switch

- The fuel consumption meter and fuel economy meter will indicate the same unit of measurement.

EMU26760

Fuel consumption meter

This gauge displays the total amount of fuel consumed since the gauge was last reset. Press the “mode” (mode) button repeatedly until the indicator on the face of the gauge points to total “TTL” (total). To reset the total fuel consumption to zero, press the “set” (set) and “mode” (mode) buttons at the same time.

FUEL MANAGEMENT

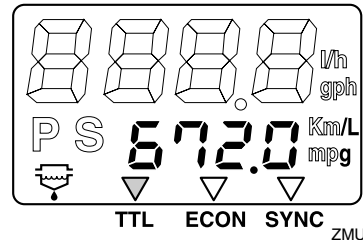

ZMU01751

EMU26770

Fuel economy

This gauge displays the distance per liter or gallon when cruising, and is only for reference use by the operator.

Press the “mode” (mode) button repeatedly

Basic components

until the indicator on the face of the gauge points to “ECON” (economy).

FUEL MANAGEMENT

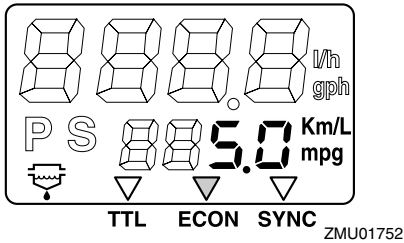

NOTE: _____
 If twin engines are installed on your boat, the gauge will only display the total fuel economy of both engines.

NOTE: _____

- Fuel consumption varies greatly with boat design, weight, propeller used, engine trim angle, sea conditions (including wind), and throttle position. Fuel consumption also varies slightly with the type of water (salt, fresh, and contaminate levels), air temperature and humidity, cleanliness of the boat bottom, engine mounting height, skill of the operator, and individual gasoline formulation (winter or summer fuel and amount of additives).
- The Yamaha digital speedometer and fuel management meter calculates speed, miles traveled, and fuel economy by water movement at the stern of the boat. This distance can vary greatly from the actual distance traveled because of water currents, sea swells, and the condition of the water speed sensor (partially plugged or damaged).
- Individual engines may slightly vary in their fuel consumption due to manufacturing variations. These variations can be even

greater if the engines are of different year models. In addition, variations in propellers, even of the same basic dimensions of the same design, can also cause a slight variation in fuel consumption.

EMU26780

Twin-engine speed synchronizer

This gauge displays the difference in engine speed (r/min) between the port and starboard engines for reference purposes when synchronizing the two engines’ speeds. Press the “mode” (mode) button repeatedly until the indicator on the face of the gauge points to “SYNC” (synchronizer).

FUEL MANAGEMENT

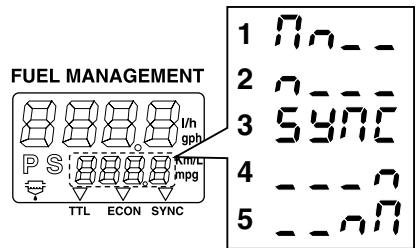
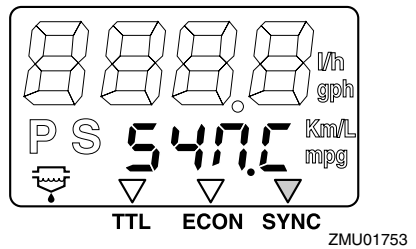

1. Port engine speed is higher
2. Port engine speed is slightly higher
3. Engine speed is synchronized evenly between port and starboard engines
4. Starboard engine speed is slightly higher
5. Starboard engine speed is higher

Basic components

NOTE:

If the two engines' speeds are not synchronized while cruising, they can be synchronized by adjusting trim angle or throttle.

EMU31651

6Y8 Multifunction meters

Multifunction meters have 6 kinds of meter units; tachometer unit (square or round types), speedometer unit (square type), speed & fuel meter unit (square or round types), and fuel management meter (square type). The indicator system is slightly different between the round and square types. Check the model and type of your unit carefully. This manual describes mainly the warning indicators. For more details on setting meters or changing indicator systems, see the attached operation manual.

EMU31660

Tachometer unit

The tachometer shows the engine revolutions per minute. It has functions of trim meter, adjusting trolling speed, cooling water/engine temperature display, battery voltage display, total hour/trip hour display, oil level display, water detection warning, engine trouble warning, and periodic maintenance notification. If optional sensors are connected to the unit, cooling water pressure display will be available. For the optional sensor, consult your Yamaha dealer. The tachometer unit is available in round or square types. Check your tachometer unit type.

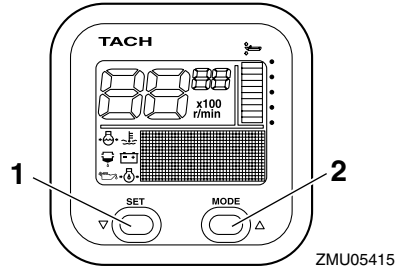

1. Set button
2. Mode button

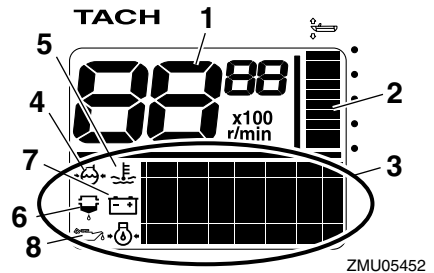

1. Tachometer
2. Trim meter
3. Multifunction display
4. Cooling water pressure
5. Cooling water/engine temperature
6. Water detection warning indicator
7. Battery voltage
8. Oil level (2-stroke models)

Basic components

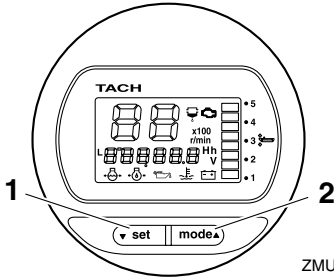

ZMU05417

1. Set button
2. Mode button

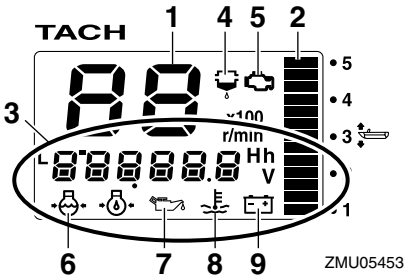

ZMU05453

1. Tachometer
2. Trim meter
3. Multifunction display
4. Water detection warning indicator
5. Engine trouble warning/maintenance indicator
6. Cooling water pressure
7. Oil level (2-stroke models)
8. Cooling water/engine temperature
9. Battery voltage

NOTE: _____

The tachometer unit shows various kinds of information according to the setting made using the “set” (set) and “mode” (mode) buttons. For details, see the attached operation manual.

Preoperation checks

Place the gear shift lever in neutral and turn the main switch to “ON” (on). After all the displays come on and the total hour display comes on, the gauge will change to normal operation. If the buzzer sounds and the water separator warning indicator blinks, consult your Yamaha dealer immediately.

NOTE: _____

To stop the buzzer, press the “set” (set) or “mode” (mode) button.

Oil level warning

When the oil level is low while cruising, the oil level warning indicator will start to blink. The engine speed will automatically decrease to about 2000 r/min.

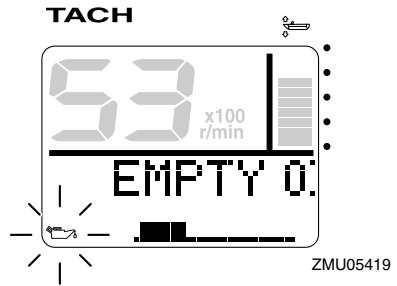

ZMU05419

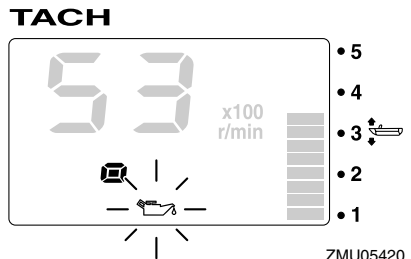

ZMU05420

When the buzzer sounds and the oil level warning indicator blinks, check the oil level and add the oil if necessary. If the warning device has activated while the appropriate

Basic components

engine oil level is maintained, consult your Yamaha dealer.

ECM01580

CAUTION:

Do not continue to run the engine if the oil level warning device has activated. Serious engine damage will occur.

Overheat warning

If the engine temperature rises too high while cruising, the overheat warning indicator will start to blink. The engine speed will automatically decrease to about 2000 r/min.

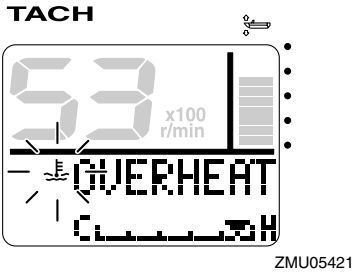

ous engine damage will occur.

- **Do not continue to operate the engine if a warning device has activated. Consult your Yamaha dealer if the problem cannot be located and corrected.**

Water separator warning

This indicator will blink when water has accumulated in the water separator (fuel filter) while cruising. In such an event, stop the engine immediately and see page 71 of this manual to drain the water from the fuel filter. Get back to the port soon and consult a Yamaha dealer immediately.

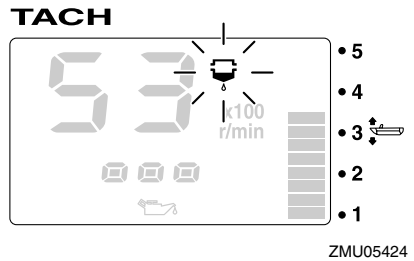
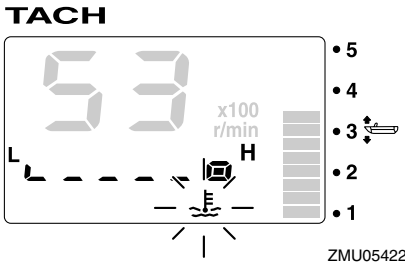
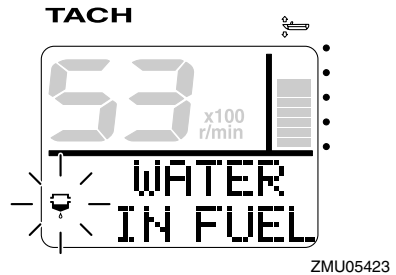

Stop the engine immediately if the buzzer sounds and the overheat warning device has activated. Check the cooling water inlet for clogging.

ECM01590

CAUTION:

- **Do not continue to run the engine if the overheat warning indicator blinks. Seri-**

ECM00910

CAUTION:

Gasoline mixed with water could cause damage to the engine.

Engine trouble warning

This indicator will blink when the engine malfunctions while cruising. Get back to the port

Basic components

soon and consult a Yamaha dealer immediately.

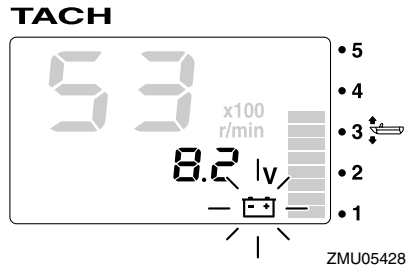
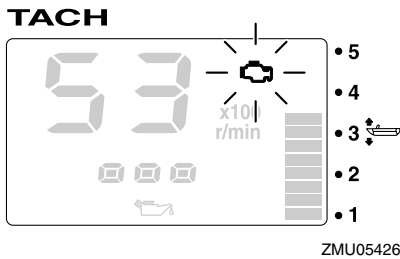
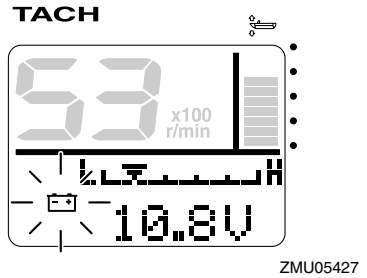
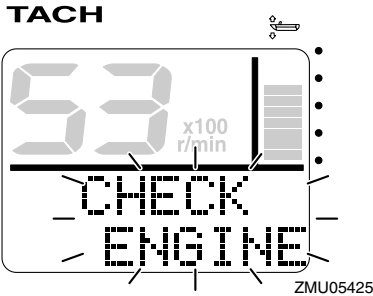

ECM00920

CAUTION: In such an event, the engine will not operate properly. Consult a Yamaha dealer immediately.

Low battery voltage warning

When the battery voltage drops, the low battery voltage warning indicator and the battery voltage value will start to blink. Get back to the port soon if the low battery voltage warning device has activated. For charging the battery, consult your Yamaha dealer.

EMU31610

Speed & fuel meter unit

This unit shows the boat speed and has the functions of fuel meter, total fuel consumption display, fuel economy display, fuel flow display, and system voltage display. If optional sensors are connected to the unit, trip display, water surface temperature display, depth display, and clock will be available. For the optional sensor, consult your Yamaha dealer. The speed & fuel meter unit is available in round or square types. Check your speed & fuel meter unit type.

Basic components

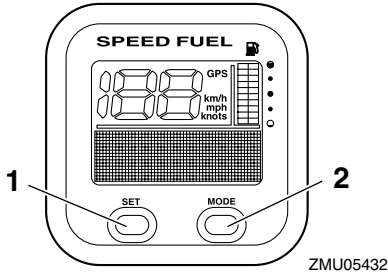

1. Set button
2. Mode button

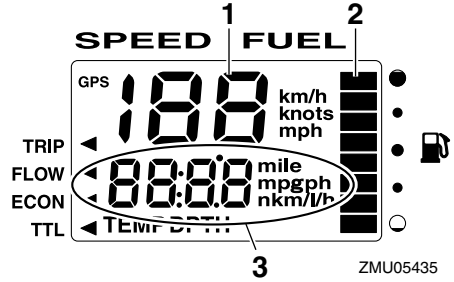

1. Speedometer
2. Fuel meter
3. Multifunction display

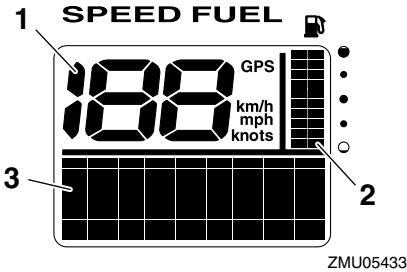

1. Speedometer
2. Fuel meter
3. Multifunction display

NOTE: After the main switch is first turned on, all the displays come on as a test. After a few seconds, the gauge will change to normal operation.

NOTE: The speed & fuel meter unit shows various kinds of information according to the setting made with the “set” (set) and “mode” (mode) buttons. For details, see the attached operation manual.

EMU31620

Speedometer unit

This unit shows the boat speed and has functions of fuel meter and system voltage display. If optional sensors are connected to the unit, trip display, water surface temperature display, depth display, and clock will be available. For the optional sensor, consult your Yamaha dealer.

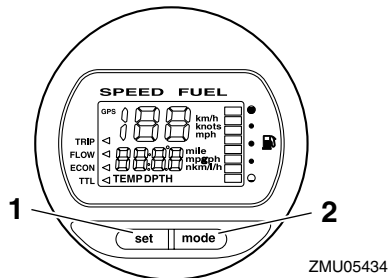

1. Set button
2. Mode button

Basic components

EMU31630

Fuel management meter

This meter has functions of fuel flow meter, total consumption display, fuel economy display, and remaining fuel display.

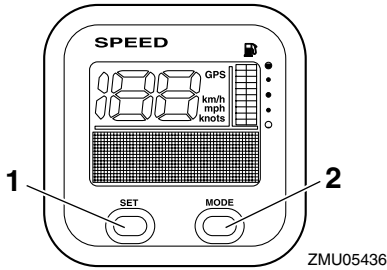

1. Set button
2. Mode button

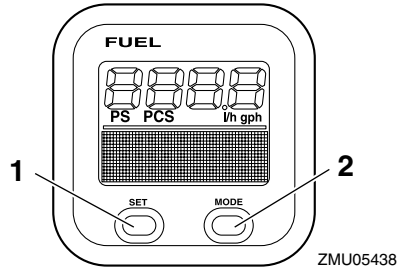

1. Set button
2. Mode button

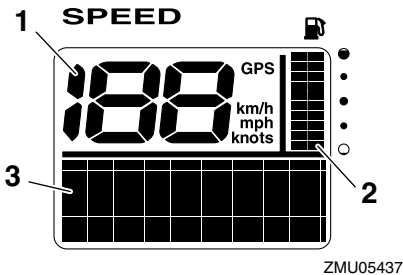

1. Speedometer
2. Fuel meter
3. Multifunction display

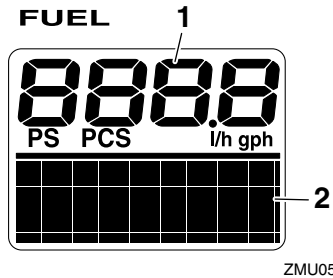

1. Fuel flow meter
2. Multifunction display

NOTE: _____
 After the main switch is first turned on, all the displays come on as a test. After a few seconds, the gauge will change to normal operation.

NOTE: _____
 The speedometer unit shows various kinds of information according to the setting made using the “set” (set) and “mode” (mode) buttons. In addition, the speedometer can show the desired unit of measurement such as km/h, mph, or knots. For details, see the attached operation manual.

NOTE: _____
 After the main switch is first turned on, all the displays come on as a test. After a few seconds, the gauge will change to normal operation.

NOTE: _____
 The fuel management meter shows various kinds of information when the operator uses the “set” (set) and “mode” (mode) buttons. For details, see the attached operation manual.

Basic components

ual.

EMU26801

Warning system

ECM00090

CAUTION:

Do not continue to operate the engine if a warning device has activated. Consult your Yamaha dealer if the problem cannot be located and corrected.

EMU26824

Overheat warning (twin engines)

This engine has an overheat warning device. If the engine temperature rises too high, the warning device will activate.

Activation of warning device

- The engine speed will automatically decrease to about 2000 r/min.
- If equipped with an overheat warning indicator, it will light or blink.

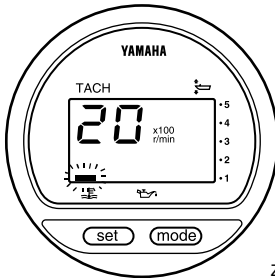

ZMU01757

- The buzzer will sound.

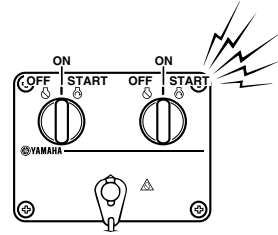
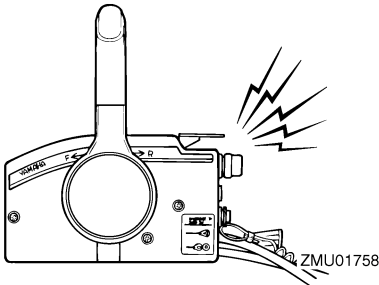

ZMU04584

If the warning system has activated, stop the engine and check the cooling water inlet for clogging.

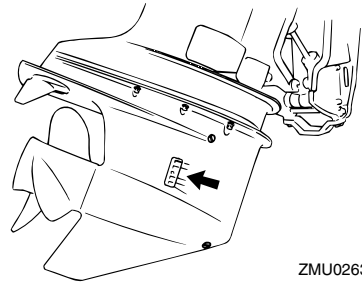

ZMU02630

NOTE:

Dual engine drive users:

Should the overheat warning system of one engine activate, the engine will slow down and the buzzer will sound. This will cause the other engine to slow down and the buzzer to sound. To switch off the warning activation on the engine not affected by overheating, turn off the main switch of the engine overheating.

EMU26846

Oil level warning and oil filter clogging warning

Oil injection models

This engine has an oil level warning system. If the oil level falls below the lower limit, the warning system will activate.

Basic components

Activation of warning device

- Engine speed will automatically decrease to about 2000 r/min.
- The oil level warning indicator will light or blink.

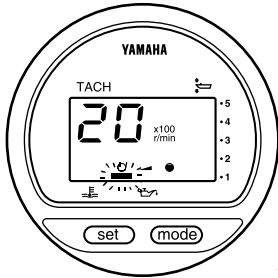

ZMU03942

- The buzzer will sound (if equipped on the tiller handle, remote control box, or main switch panel).

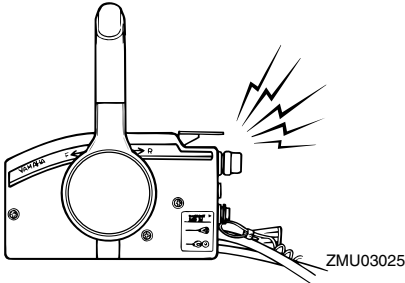

ZMU03025

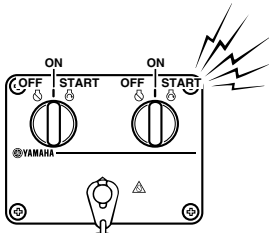

ZMU04584

If the warning system has been activated, stop the engine and check for the cause.

NOTE:

The warning for oil filter clogging is similar to the warnings for low oil level and overheating. To make troubleshooting easier, check for engine overheating first, then oil level, and finally oil filter clogging.

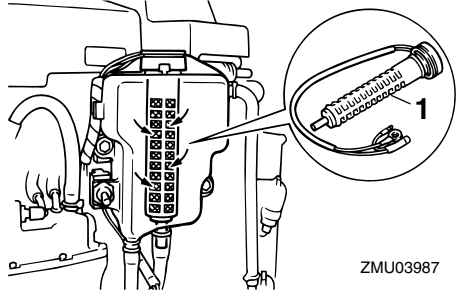

ZMU03987

1. Oil filter

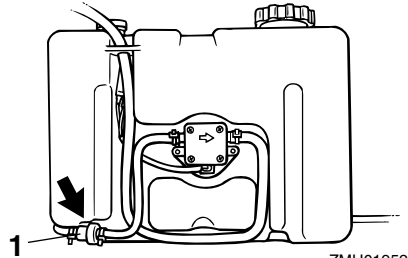

ZMU01952

1. Oil filter

Operation

EMU26901

Installation

ECM00110

CAUTION:

Incorrect engine height or obstructions to smooth water flow (such as the design or condition of the boat, or accessories such as transom ladders or depth finder transducers) can create airborne water spray while the boat is cruising. Severe engine damage may result if the motor is operated continuously in the presence of airborne water spray.

NOTE:

During water testing check the buoyancy of the boat, at rest, with its maximum load. Check that the static water level on the exhaust housing is low enough to prevent water entry into the powerhead, when water rises due to waves when the outboard is not running.

EMU26910

Mounting the outboard motor

EWM00820

WARNING

- Overpowering a boat could cause severe instability. Do not install an outboard motor with more horsepower than the maximum rating on the capacity plate of the boat. If the boat does not have a capacity plate, consult the boat manufacturer.
- The information presented in this section is intended as reference only. It is not possible to provide complete instructions for every possible boat and motor combination. Proper mounting depends in part on experience and the

specific boat and motor combination.

EWM00830

WARNING

Improper mounting of the outboard motor could result in hazardous conditions such as poor handling, loss of control, or fire hazards. Observe the following:

- For permanently mounted models, your dealer or other person experienced in proper rigging should mount the motor. If you are mounting the motor yourself, you should be trained by an experienced person.
- For portable models, your dealer or other person experienced in proper outboard motor mounting should show you how to mount your motor.

Mount the outboard motor on the center line (keel line) of the boat, and ensure that the boat itself is well balanced. Otherwise the boat will be hard to steer. For boats without a keel or which are asymmetrical, consult your dealer.

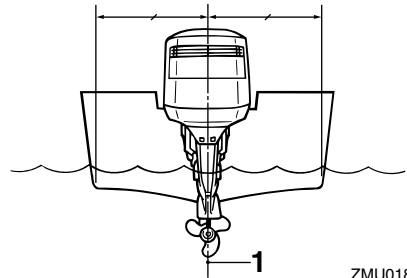

ZMU01873

1. Center line (keel line)

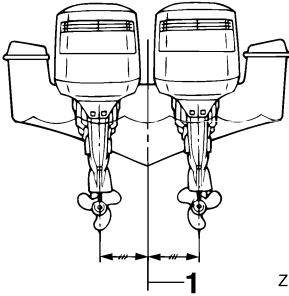

ZMU01761

1. Center line (keel line)

EMU26930

Mounting height (boat bottom)

To run your boat at optimum efficiency, the water resistance (drag) of the boat and outboard motor must be made as little as possible. The mounting height of the outboard motor greatly affects the water resistance. If the mounting height is too high, cavitation tends to occur, thus reducing the propulsion; and if the propeller tips cut the air, the engine speed will rise abnormally and cause the engine to overheat. If the mounting height is too low, the water resistance will increase and thereby reduce engine efficiency. Mount the outboard motor so that the anti-cavitation plate is in alignment with the bottom of the boat.

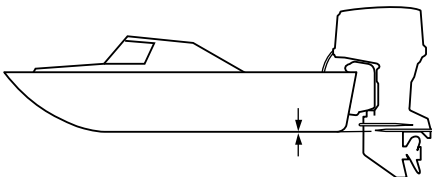

ZMU01762

NOTE: _____

- The optimum mounting height of the out-

board motor is affected by the boat/motor combination and the desired use. Test runs at different heights can help determine the optimum mounting height. Consult your Yamaha dealer or boat manufacturer for further information on determining the proper mounting height.

- For instructions on setting the trim angle of the outboard motor, see page 41.

EMU27041

Breaking in engine

Your new engine requires a period of break-in to allow mating surfaces of moving parts to wear in evenly. Correct break-in will help ensure proper performance and longer engine life.

ECM00750

CAUTION: _____

- **Failure to follow the break-in procedure could result in reduced engine life or even severe engine damage.**
- **Do not use premixed fuel in this engine because it could cause carbon deposits on the fuel injector and engine trouble.**
- **Follow the instructions for break-in carefully.**

NOTE: _____

Leave the label pictured below on the top cowling until the break-in procedure has been completed. It may be removed afterwards.



ZMU01945

EMU27091

Procedure for HPDI models

Run the engine under load (in gear with a propeller installed) for 10 hours as follows.

1. First 10 minutes:
Run the engine at the lowest possible speed. A fast idle in neutral is best.
2. Next 50 minutes:
Do not exceed half throttle (approximately 3000 r/min). Vary engine speed occasionally. If you have an easy-planing boat, accelerate at full throttle onto plane, then immediately reduce the throttle to 3000 r/min or less.
3. Next two hours:
Accelerate at full throttle onto plane, then reduce engine speed to three-quarter throttle (approximately 4000 r/min). Vary engine speed occasionally. Run at full throttle for one minute, then allow about 10 minutes of operation at three-

quarter throttle or less to let the engine cool.

4. Remaining seven hours:
Run the engine at any speed. However, avoid operating at full throttle for more than 5 minutes at a time.
5. After the first 10 hours:
Operate the engine normally.

EMU27103

Preoperation checks

EWM00080



WARNING

If any item in the preoperation check is not working properly, have it inspected and repaired before operating the outboard motor. Otherwise an accident could occur.

ECM00120

CAUTION:

Do not start the engine out of water. Overheating and serious engine damage can occur.

EMU31550

Fuel

- Check to be sure you have plenty of fuel for your trip.
- Make sure there are no fuel leaks or gasoline fumes.
- Check fuel line connections to be sure they are tight (if equipped Yamaha fuel tank or boat tank).
- Be sure the fuel tank is positioned on a secure, flat surface, and that the fuel line is not twisted or flattened, or likely to contact sharp objects (if equipped Yamaha fuel tank or boat tank).
- Check the water in the fuel filter with the water separator warning device. Place the gear shift lever in neutral and turn the main switch to "ON"(on). If the buzzer sounds and the water separator warning indicator

blinks, consult your Yamaha dealer immediately.

EMU27120

Oil

- Check to be sure you have plenty of oil for your trip.

EMU27130

Controls

- Check throttle, shift, and steering for proper operation before starting the engine.
- The controls should work smoothly, without binding or unusual free play.
- Look for loose or damaged connections.
- Check operation of the starter and stop switches when the outboard motor is in the water.

EMU27150

Engine

- Check the engine and engine mounting.
- Look for loose or damaged fasteners.
- Check the propeller for damage.
- Check that the battery is in good condition and the battery connections are secure.

EMU27221

Operation after a long period of storage

When operating the engine after a long period (12 months) of storage, proceed as follows:

1. Start the engine. Leave it idling.

EWM00090

WARNING

- **Do not touch or remove electrical parts when starting or during operation.**
 - **Keep hands, hair, and clothes away from the flywheel and other rotating parts while the engine is running.**
-
2. Watch for oil flowing through the oil feed pipes. After any air in the oil lines has been expelled, the oil injection system should supply oil normally. If no oil is flowing after 10 minutes of idling, consult

your Yamaha dealer.

ECM00560

CAUTION:

- **Be sure to take the above steps when operating the engine after a long period of storage. Otherwise engine seizure could occur.**
- **Use straight gasoline only. If premix fuel is used, the fuel injector could be damaged.**

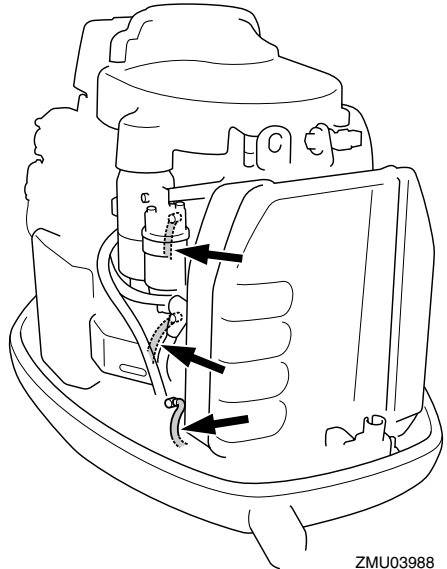

ZMU03988

Operation

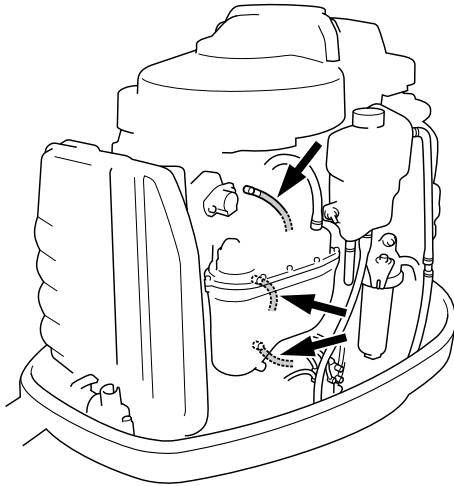

ZMU03989

EMU27233

Filling fuel and engine oil

EMU30320

Filling fuel for models without a fuel joint

EWM00060



WARNING

Gasoline and its vapors are highly flammable and explosive. Keep away from sparks, cigarettes, flames, or other sources of ignition.

1. Remove the fuel tank cap.
2. Carefully fill the fuel tank.
3. Securely close the cap after filling the tank. Wipe up any spilled fuel.

EMU27292

Filling oil for oil injection models

EWM00530



WARNING

Do not add gasoline into the oil tank. Fire or explosion could result.

This engine uses the Yamaha oil injection system, which provides superior lubrication by ensuring the proper oil ratio for all operating conditions. No fuel premixing is needed. Simply pour gasoline into the fuel tank and oil into the oil tank. Convenient indicators show the status of the oil supply. For details on how to read the indicators, see page 36.

To fill the engine oil tank, proceed as follows:

1. Pour engine oil into the remote oil tank.

Remote oil tank capacity:

10.5 L (11.10 US qt) (9.24 Imp.qt)

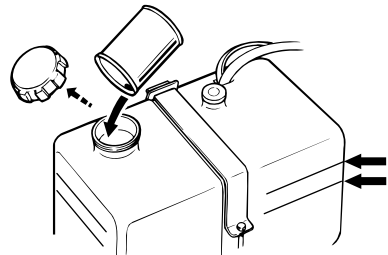

ZMU01877

NOTE:

The oil level lines on the remote oil tank indicate the amount of additional oil that can be added to the tank. The top oil level line indicates approximately 1.9 L (0.5 US gal, 0.4 Imp gal) can be added, and the bottom oil level line indicates approximately 3.8 L (1 US gal, 0.8 Imp gal) can be added.

2. Turn on the main switch. The Yamaha oil injection system will automatically feed oil from the remote oil tank to the engine oil tank.
3. Operate the engine normally.

ECM00570

CAUTION:

When the engine is operated for the first time or stored for a period of time, a min-

imum of 5 liters (5.3 US qt, 4.4 Imp qt) of oil should be kept in the remote oil tank. Otherwise the oil-feed pump chamber will not be filled with oil, and no oil will be supplied.

Operation

EMU27321

Oil level indicator operation

The various functions of the oil level system are as follows:

EMU27381

Oil level indicator

Electric start models

Oil level warning indicator (digital tachometer)	Oil level warning indicator (analog tachometer)	Engine oil tank	Remote oil tank	Remarks
	Green 	more than 300 cm ³ (0.32 US qt, 0.26 Imp qt) 	more than 1500 cm ³ (1.6 US qt, 1.31 Imp qt) 	<ul style="list-style-type: none"> ● No refilling necessary.
	Yellow 	more than 300 cm ³ (0.32 US qt, 0.26 Imp qt) 	1500 cm ³ (1.6 US qt, 1.31 Imp qt) or less 	<ul style="list-style-type: none"> ● Add oil; see page 34.
	Red–Yellow– Green 	300 cm ³ (0.32 US qt, 0.26 Imp qt) or less 	more than 1500 cm ³ (1.6 US qt, 1.31 Imp qt) 	<ul style="list-style-type: none"> ● Check oil filter for clogging. ● Check battery cable connection. Buzzer will sound. ● Engine speed is automatically reduced to about 2000 r/min.
	Red 	300 cm ³ (0.32 US qt, 0.26 Imp qt) or less 	1500 cm ³ (1.6 US qt, 1.31 Imp qt) or less 	<ul style="list-style-type: none"> ● Oil has not been added. ● Buzzer will sound. ● Engine speed is automatically reduced to about 2000 r/min. ● Buzzer sounds in remote control box and engine speed is limited to about 2000 r/min to help conserve oil.

EMU27450

Operating engine

EMU27482

Feeding fuel

EWM00420

WARNING

- Before starting the engine, make sure that the boat is tightly moored and that you can steer clear of any obstructions. Be sure there are no swimmers in the water near you.
- When the air vent screw is loosened, gasoline vapor will be released. Gasoline is highly flammable, and its vapors are flammable and explosive. Refrain from smoking, and keep away from open flames and sparks while loosening the air vent screw.
- This product emits exhaust gases which contain carbon monoxide, a colorless, odorless gas which could cause brain damage or death when inhaled. Symptoms include nausea, dizziness, and drowsiness. Keep cockpit and cabin areas well ventilated. Avoid blocking exhaust outlets.

1. If there is an air vent screw on the fuel tank cap, loosen it 2 or 3 turns.
2. If there is a fuel joint or a fuel cock on the boat, firmly connect the fuel line to the joint or open the fuel cock.
3. Squeeze the primer pump, with the arrow pointing up, until you feel it become firm.

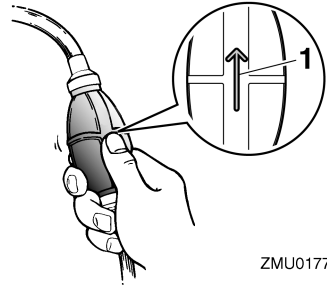

ZMU01770

1. Arrow

EMU27490

Starting engine

EMU27624

Electric start and remote control models

1. Place the remote control lever in "N" (neutral).

NOTE:

The start-in-gear protection device prevents the engine from starting except when in neutral.

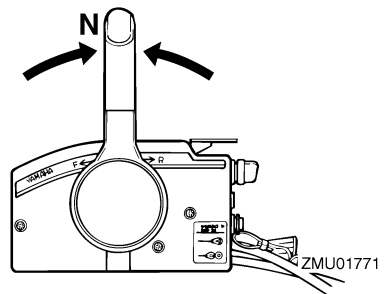

ZMU01771

Operation

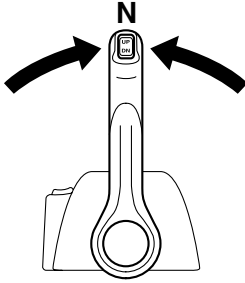

ZMU04588

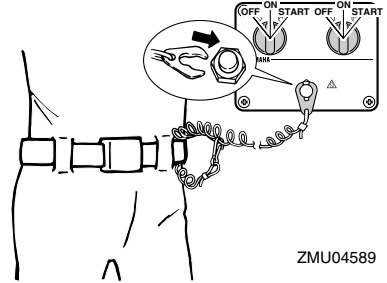

ZMU04589

2. Attach the engine stop switch lanyard to a secure place on your clothing, or your arm or leg. Then install the lock plate on the other end of the lanyard into the engine stop switch.

EWM00120

WARNING

- Attach the engine stop switch lanyard to a secure place on your clothing, or your arm or leg while operating.
- Do not attach the lanyard to clothing that could tear loose. Do not route the lanyard where it could become entangled, preventing it from functioning.
- Avoid accidentally pulling the lanyard during normal operation. Loss of engine power means the loss of most steering control. Also, without engine power, the boat could slow rapidly. This could cause people and objects in the boat to be thrown forward.

3. Turn the main switch to “ON” (on).

NOTE:

Dual engine users: When the main switch is turned on, the buzzer operates for a few seconds then stops automatically. The buzzer also operates if one of the engines stalls.

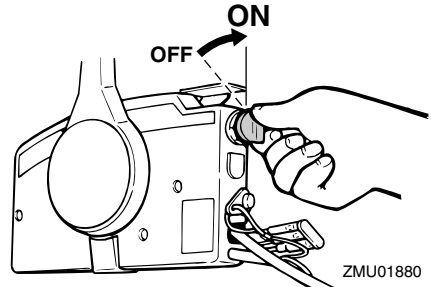

ZMU01880

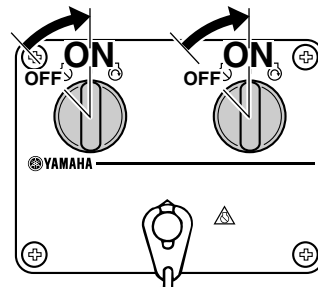

ZMU04591

4. Turn the main switch to “START” (start), and hold it for a maximum of 5 seconds.

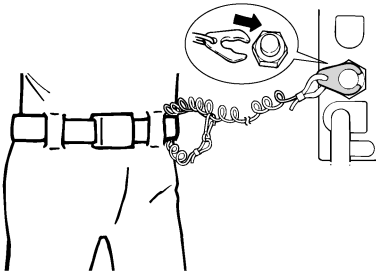

ZMU01772

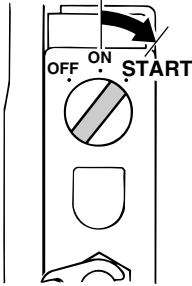

ZMU01881

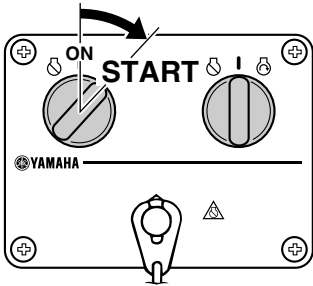

ZMU04590

5. Immediately after the engine starts, release the main switch to return it to "ON" (on).

ECM00191

CAUTION:

- Never turn the main switch to "START" (start) while the engine is running.
- Do not keep the starter motor turning for more than 5 seconds. If the starter motor is turned continuously for more than 5 seconds, the battery will be quickly discharged, thus making it impossible to start the engine. The starter can also be damaged. If the engine will not start after 5 seconds of cranking, return the main switch to "ON" (on), wait 10 seconds, then crank the engine again.

EMU27670

Warming up engine

EMU27702

Electric start and prime start models

1. After starting the engine, allow it to idle for 3 minutes to warm up. Failure to do so will shorten engine life.
2. Check for a steady flow of water from the cooling water pilot hole.

ECM00511

CAUTION:

A continuous flow of water from the cooling water pilot hole shows that the water pump is pumping water through the cooling passages. If water is not flowing out of the hole at all times while the engine is running, overheating and serious damage could occur. Stop the engine and check whether the cooling water inlet on the lower case or the cooling water pilot hole is blocked. Consult your Yamaha dealer if the problem cannot be located and corrected.

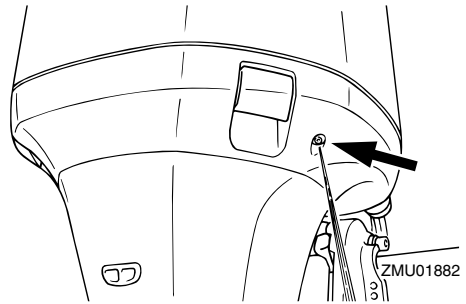

ZMU01882

EMU27740

Shifting

EWMM0180

WARNING

Before shifting, make sure there are no swimmers or obstacles in the water near

Operation

you.

ECM00220

CAUTION:

To change the boat direction or shifting position from forward to reverse or vice-versa, first close the throttle so that the engine idles (or runs at low speeds).

EMU27764

Forward (tiller handle and remote control models)

Tiller handle models

1. Place the throttle grip in the fully closed position.
2. Move the gear shift lever quickly and firmly from neutral to forward.

Remote control models

1. Pull up the neutral interlock trigger (if equipped) and move the remote control lever quickly and firmly from neutral to forward.

EMU27785

Reverse (automatic reverse lock and power trim and tilt models)

EWM00190

WARNING

When operating in reverse, go slowly. Do not open the throttle more than half. Otherwise the boat could become unstable, which could result in loss of control and an accident.

Tiller handle models

1. Place the throttle grip in the fully closed position.
2. Move the gear shift lever quickly and firmly from neutral to reverse.

Remote control models

1. Pull up the neutral interlock trigger (if equipped) and move the remote control lever quickly and firmly from neutral to reverse.

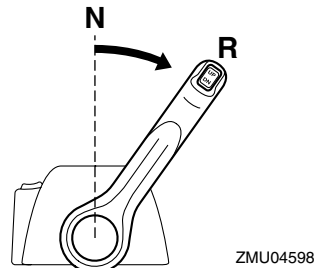
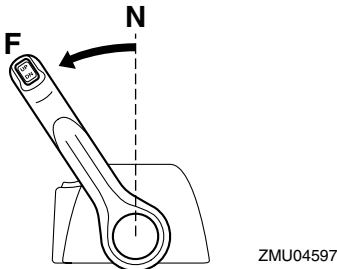
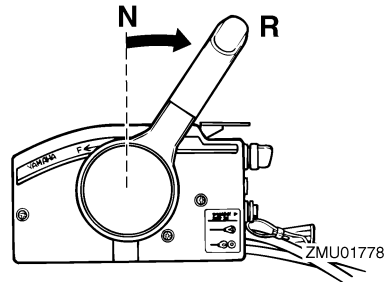
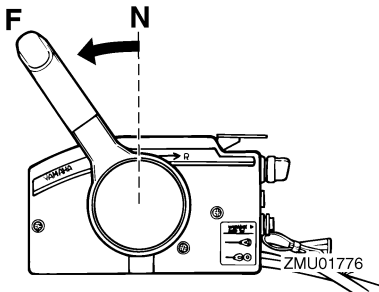

EMU27820

Stopping engine

Before stopping the engine, first let it cool off for a few minutes at idle or low speed. Stopping the engine immediately after operating at high speed is not recommended.

EMU27852

Procedure

1. Turn the main switch to “OFF” (off).

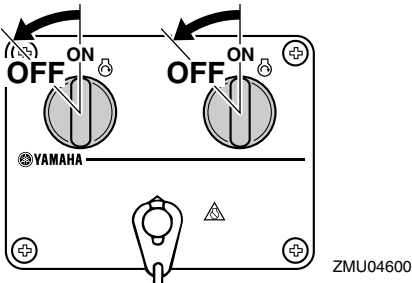
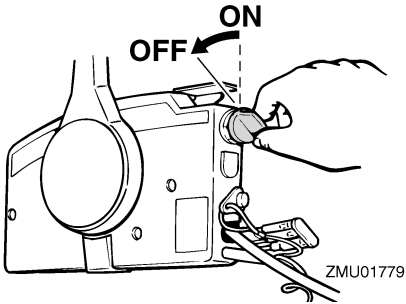

2. After stopping the engine, disconnect the fuel line or close the fuel cock if there is a fuel joint or a fuel cock on the boat.
3. Tighten the air vent screw on the fuel tank cap (if equipped).
4. Remove the key if the boat will be left unattended.

NOTE:

The engine can also be stopped by pulling the lanyard and removing the clip from the engine stop switch, then turning the main

switch to “OFF” (off).

EMU27861

Trimming outboard motor

The trim angle of the outboard motor helps determine the position of the bow of the boat in the water. Correct trim angle will help improve performance and fuel economy while reducing strain on the engine. Correct trim angle depends upon the combination of boat, engine, and propeller. Correct trim is also affected by variables such as the load in the boat, sea conditions, and running speed.

EWM00740

WARNING

Excessive trim for the operating conditions (either trim up or trim down) can cause boat instability and can make steering the boat more difficult. This increases the possibility of an accident. If the boat begins to feel unstable or is hard to steer, slow down and/or readjust the trim angle.

Operation

not adjust the trim angle with this switch while the boat is moving.

Adjust the outboard motor trim angle using the power trim and tilt switch.

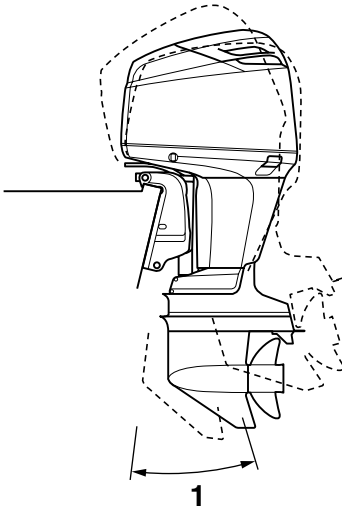

ZMU04718

1. Trim operating angle

EMU27882

Adjusting trim angle

Power trim and tilt models

EWM00751

WARNING

- Be sure all people are clear of the outboard motor when adjusting the tilt angle, also be careful not to pinch any body parts between the drive unit and clamp bracket.
- Use caution when trying a trim position for the first time. Increase speed gradually and watch for any signs of instability or control problems. Improper trim angle can cause loss of control.
- If equipped with a power trim and tilt switch located on the bottom cowling, use the switch only when the boat is at a complete stop with the engine off. Do

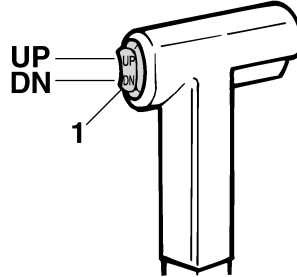

ZMU01781

1. Power trim and tilt switch

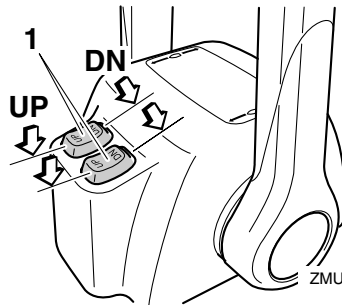

ZMU04601

1. Power trim and tilt switch

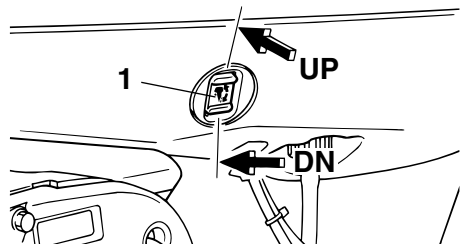

ZMU04615

1. Power trim and tilt switch

To raise the bow (trim-out), press the switch “UP” (up).

To lower the bow (trim-in), press the switch “DN” (down).

Make test runs with the trim set to different angles to find the position that works best for your boat and operating conditions.

EMU27911

Adjusting boat trim

When the boat is on plane, a bow-up attitude results in less drag, greater stability and efficiency. This is generally when the keel line of the boat is up about 3 to 5 degrees. With the bow up, the boat may have a greater tendency to steer to one side or the other. Compensate for this as you steer. The trim tab can also be adjusted to help offset this effect. When the bow of the boat is down, it is easier to accelerate from a standing start onto plane.

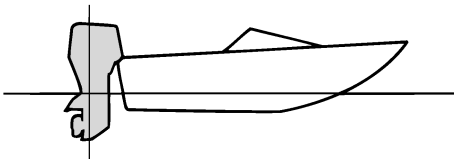

ZMU01784

Bow Up

Too much trim-out puts the bow of the boat too high in the water. Performance and economy are decreased because the hull of the boat is pushing the water and there is more air drag. Excessive trim-out can also cause the propeller to ventilate, which reduces performance further, and the boat may “porpoise” (hop in the water), which could throw the operator and passengers overboard.

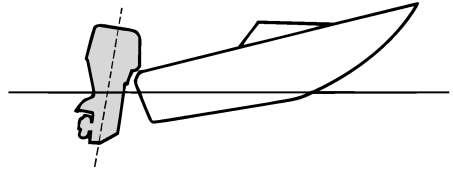

ZMU01785

Bow Down

Too much trim-in causes the boat to “plow” through the water, decreasing fuel economy and making it hard to increase speed. Operating with excessive trim-in at higher speeds also makes the boat unstable. Resistance at the bow is greatly increased, heightening the danger of “bow steering” and making operation difficult and dangerous.

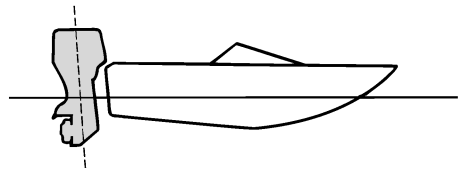

ZMU01786

NOTE:

Depending on the type of boat, the outboard motor trim angle may have little effect on the trim of the boat when operating.

EMU27933

Tilting up and down

If the engine will be stopped for some time or if the boat is moored in shallows, the outboard motor should be tilted up to protect the propeller and casing from damage by collision with obstructions, and also to reduce

Operation

salt corrosion.

EWM00220

WARNING

Be sure all people are clear of the outboard motor when tilting up and down, also be careful not to pinch any body parts between the drive unit and engine bracket.

EWM00250

WARNING

Leaking fuel is a fire hazard. If there is a fuel joint on the outboard motor, disconnect the fuel line or close the fuel cock if the engine will be tilted for more than a few minutes. Otherwise fuel may leak.

ECM00241

CAUTION:

- Before tilting the outboard motor, stop the engine by following the procedure on page 41. Never tilt the outboard motor while the engine is running. Severe damage from overheating can result.
- Do not tilt up the engine by pushing the tiller handle (if equipped) because this could break the handle.

EMU28007

Procedure for tilting up (power trim and tilt models / power tilt models)

1. Place the remote control lever / gear shift lever in neutral.

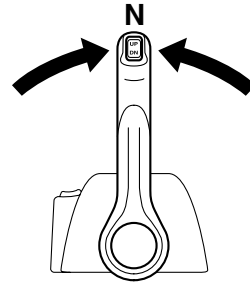
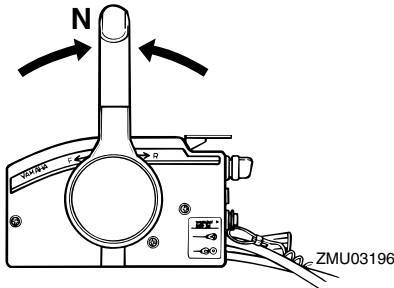

2. Disconnect the fuel line from the outboard motor or close the fuel cock.
3. Press the power trim and tilt switch / power tilt switch "UP" (up) until the outboard motor has tilted up completely.

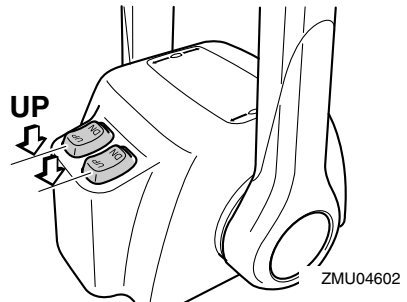
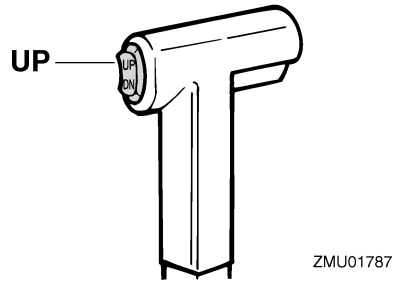

from marine growth and corrosion which could damage the power trim and tilt mechanism.

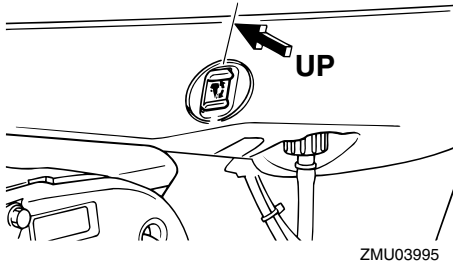

4. Push the tilt support knob into the clamp bracket or pull the tilt support lever toward you to support the engine.

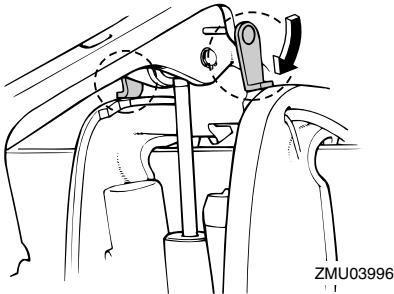

EWM00260

WARNING

After tilting the outboard motor, be sure to support it with the tilt support knob or tilt support lever. Otherwise the outboard motor could fall back down suddenly if oil in the power trim and tilt unit loses pressure.

5. Models equipped with trim rods: Once the outboard motor is supported with the tilt support lever, press the power trim and tilt switch / power tilt switch "DN" (down) to retract the trim rods.

ECM00250

CAUTION:

Be sure to retract the trim rods completely during mooring. This protects the rods

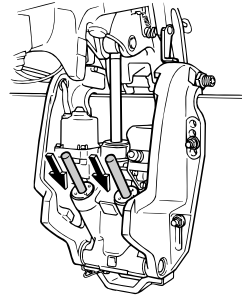

EMU28055

Procedure for tilting down (power trim and tilt models / power tilt models)

1. Push the power trim and tilt switch / power tilt switch "UP" (up) until the outboard motor is supported by the tilt rod and the tilt support lever / tilt support knob becomes free.
2. Release the tilt support lever or pull out the tilt support knob.

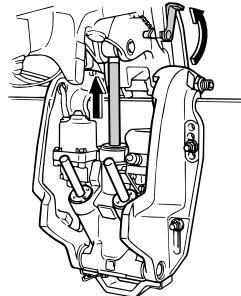

3. Push the power trim and tilt switch / power tilt switch "DN" (down) to lower the outboard motor to the desired position.

Operation

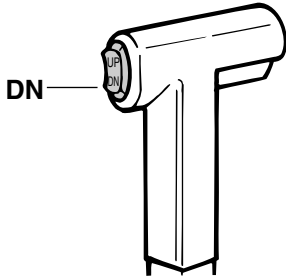

ZMU01936

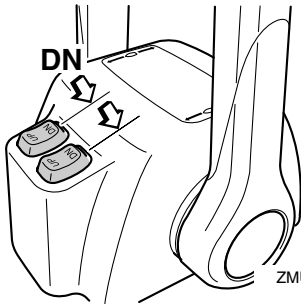

ZMU04603

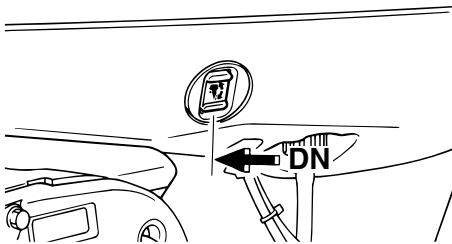

ZMU03999

EMU28060

Cruising in shallow water

The outboard motor can be tilted up partially to allow operation in shallow water.

EMU28090

Power trim and tilt models / power tilt models

The outboard motor can be tilted up partially

to allow operation in shallow water.

EWM00660

WARNING

- Place the gear shift in neutral before setting up for shallow water cruising.
- Return the outboard motor to its normal position as soon as the boat is back in deeper water.

ECM00260

CAUTION:

Do not tilt the outboard motor up so that the cooling water inlet on the lower unit is above the surface of the water when setting up for and cruising in shallow water. Otherwise severe damage from overheating can result.

EMU28185

Procedure for power trim and tilt / power tilt models

1. Place the remote control lever / gear shift lever in neutral.

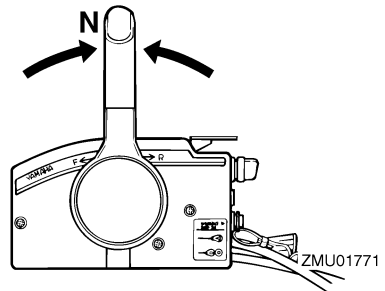

ZMU01771

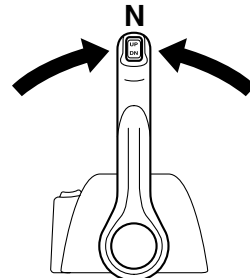

ZMU04588

2. Slightly tilt the outboard motor up to the desired position using the power trim and tilt switch / power tilt switch.

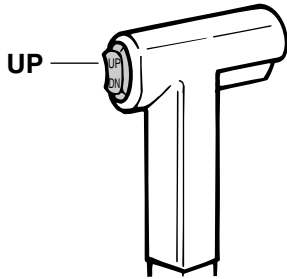

ZMU01935

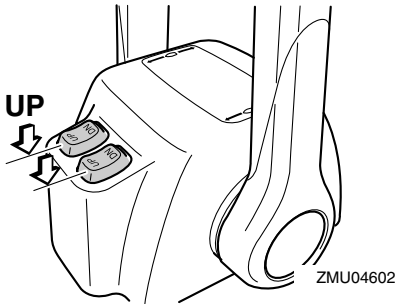

ZMU04602

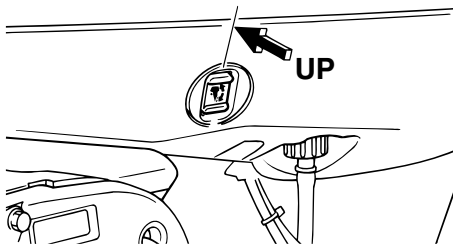

ZMU04000

3. To return the outboard motor to the normal running position, press the power trim and tilt switch / power tilt switch and slowly tilt the outboard motor down.

EMU28192

Cruising in other conditions

Cruising in salt water

After operating in salt water, flush the cooling

water passages with fresh water to prevent them from becoming clogged with salt deposits.

NOTE:

For cooling system flushing instructions, see page 49.

Cruising in turbid water

Yamaha strongly recommends that you use the optional chromium-plated water pump kit (not available for some models) if you use the outboard motor in turbid or muddy water conditions.

Maintenance

EMU31480

Specifications

NOTE:

“(AL)” stated in the specification data below represents the numerical value for the aluminum propeller installed.

Likewise, “(SUS)” represents the value for stainless steel propeller installed and “(PL)” for plastic propeller installed.

EMU28218

Dimension:

Overall length:

792 mm (31.2 in)

Overall width:

554 mm (21.8 in)

Overall height L:

1655 mm (65.2 in)

Overall height X:

1782 mm (70.2 in)

Transom height L:

516 mm (20.3 in)

Transom height X:

643 mm (25.3 in)

Weight (AL) L:

214.0 kg (472 lb)

Weight (AL) X:

218.0 kg (481 lb)

Weight (SUS) L:

216.0 kg (476 lb)

Weight (SUS) X:

220.0 kg (485 lb)

Performance:

Full throttle operating range:

4500–5500 r/min

Maximum output:

LZ150PETO 110.3 kW@5000 r/min

(150 HP@5000 r/min)

LZ200NETO 147.1 kW@5000 r/min

(200 HP@5000 r/min)

Z150PETO 110.3 kW@5000 r/min

(150 HP@5000 r/min)

Z175GETO 128.7 kW@5000 r/min

(175 HP@5000 r/min)

Z200NETO 147.1 kW@5000 r/min

(200 HP@5000 r/min)

Idling speed (in neutral):

LZ150PETO 700 ±30 r/min

LZ200NETO 700 ±30 r/min

Z150PETO 700 ±30 r/min

Z175GETO 750 ±30 r/min

Z200NETO 700 ±30 r/min

Engine:

Type:

2-stroke V

Displacement:

2596.0 cm³ (158.41 cu.in)

Bore × stroke:

90.0 × 68.0 mm (3.54 × 2.68 in)

Ignition system:

TCI

Spark plug with resistor (NGK):

LZ150PETO BKR6EKU

LZ200NETO BKR7EKU

Z150PETO BKR6EKU

Z175GETO BKR7EKU

Z200NETO BKR7EKU

Spark plug gap:

1.5–1.6 mm (0.059–0.063 in)

Control system:

Remote control

Starting system:

Electric

Starting carburetion system:

Electronic fuel injection

Min. cold cranking amps (CCA/EN):

711.0 A

Min. rated capacity (20HR/IEC):

100.0 Ah

Alternator output for battery DC:

45.0 A

Drive unit:

Gear positions:

Forward-neutral-reverse

Gear ratio:

1.86 (26/14)

Trim and tilt system:

Power trim and tilt

Propeller mark:

LZ150PETO ML

LZ200NETO ML

Z150PETO M

Z175GETO M

Z200NETO M

Fuel and oil:

Recommended fuel:

Regular unleaded gasoline

Min. research octane:

90

Recommended engine oil:

YAMALUBE 2-stroke outboard motor oil

Lubrication:

Oil injection

Engine oil tank capacity:

0.9 L (0.95 US qt) (0.79 Imp.qt)

Remote oil tank capacity:

10.5 L (11.10 US qt) (9.24 Imp.qt)

Recommended gear oil:

Hypoid gear oil SAE#90

Gear oil quantity:

LZ150PETO 870.0 cm³ (29.41 US oz) (30.68 Imp.oz)

LZ200NETO 870.0 cm³ (29.41 US oz) (30.68 Imp.oz)

Z150PETO 980.0 cm³ (33.13 US oz) (34.56 Imp.oz)

Z175GETO 980.0 cm³ (33.13 US oz) (34.56 Imp.oz)

Z200NETO 980.0 cm³ (33.13 US oz) (34.56 Imp.oz)

Tightening torque for engine:

Spark plug:

25.0 Nm (18.4 ft-lb) (2.55 kgf-m)

Propeller nut:

55.0 Nm (40.6 ft-lb) (5.61 kgf-m)

EMU28222

Transporting and storing outboard motor

EWM00690

WARNING

- Leaking fuel is a fire hazard. When transporting and storing the outboard motor, close the air vent screw and fuel cock to prevent fuel from leaking.
- USE CARE when transporting fuel tank, whether in a boat or car.
- DO NOT fill fuel container to maximum capacity. Gasoline will expand considerably as it warms up and can build up pressure in the fuel container. This can cause fuel leakage and a potential fire hazard.

EWM00700

WARNING

Never get under the lower unit while it is tilted, even if a motor support bar is used. Severe injury could occur if the outboard motor accidentally falls.

ECM00660

CAUTION:

Do not use the tilt support lever or knob when trailering the boat. The outboard motor could shake loose from the tilt support and fall. If the motor cannot be trailered in the normal running position, use an additional support device to secure it in the tilt position.

The outboard motor should be trailered and stored in the normal running position. If there is insufficient road clearance in this position, then trailer the outboard motor in the tilt position using a motor support device such as

Maintenance

a transom saver bar. Consult your Yamaha dealer for further details.

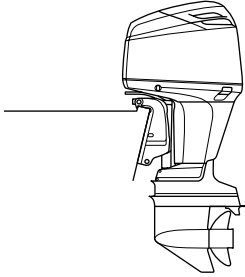

ZMU04720

EMU28260

Storing outboard motor

When storing your Yamaha outboard motor for prolonged periods of time (2 months or longer), several important procedures must be performed to prevent excessive damage. This is especially important for your oil injection-equipped outboard motor due to the lean oil ratios used at idle prior to shutting the engine off for the season. It is advisable to have your outboard motor serviced by an authorized Yamaha dealer prior to storage. However, you, the owner, with a minimum of tools, can perform the following procedures.

ECM01150

CAUTION:

- Do not use any chemical goods containing Silicon, Phosphorus, or Lead.
 - Otherwise the oxygen sensor for the Electronic Fuel Injection system could be damaged. Consult your Yamaha dealer for details on the use of chemical goods for storage.
 - Drain the remaining gasoline from the vapor separator. Gasoline left in the vapor separator for a prolonged period of time will break down and could cause damage to the fuel line.
-

EMU28303

Procedure

EMU29953

Flushing with the flushing attachment

1. Wash the outboard motor body using fresh water. For further information, see page 53.
2. Disconnect the fuel line from the motor or shut off the fuel cock, if equipped.
3. Remove the top cowling and propeller.
4. Install the flushing attachment over the cooling water inlet.

ECM00300

CAUTION:

Do not run the engine without supplying it with cooling water. Either the engine water pump will be damaged or the engine will be damaged from overheating. Before starting the engine, be sure to supply water to the cooling water passages.

ECM00310

CAUTION:

Avoid running the outboard motor at high speed while on the flushing attachment, otherwise overheating could occur.

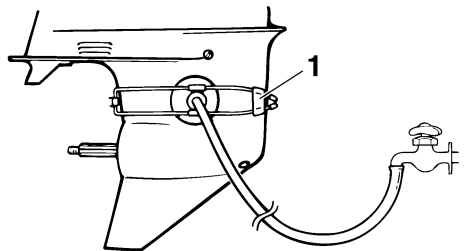

ZMU01830

1. Flushing attachment

5. Cooling system flushing is essential to prevent the cooling system from clogging up with salt, sand, or dirt. In addi-

tion, fogging/lubricating the engine is mandatory to prevent excessive engine damage due to rust. Perform the flushing and fogging at the same time.

EWM00090

WARNING

- Do not touch or remove electrical parts when starting or during operation.
- Keep hands, hair, and clothes away from the flywheel and other rotating parts while the engine is running.

NOTE:

- When using the flushing attachment, maintain adequate water pressure and a steady water flow.
 - If the overheat warning device is activated, turn the engine off, and consult your Yamaha dealer.
6. Run the engine at a fast idle for a few minutes in neutral position.
 7. Just prior to turning off the engine, quickly spray “Fogging Oil” alternately into the intake silencer or the fogging hole of the silencer cover, if equipped. When properly done, the engine will smoke excessively and almost stall.
 8. Drain the remained gasoline in the vapor separator with a container. Loosen the drain screw, and then remove the cap. Push in the air valve with a screwdriver to introduce air into the float chamber, so that the gasoline will drain smoothly. Then, tighten the drain screw.

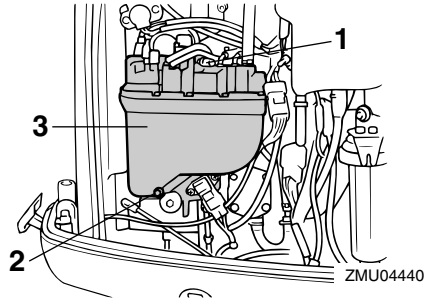

1. Air valve
2. Drain screw
3. Vapor separator

9. Remove the flushing attachment.
10. Install the top cowling.
11. If “Fogging Oil” is not available, turn off the engine after the 6 step. Then perform the 8 step procedure.
12. Drain the cooling water completely out of the motor. Clean the body thoroughly.
13. If the “Fogging Oil” is not available, remove the spark plug(s). Pour a teaspoonful of clean engine oil into each cylinder. Crank several times manually. Replace the spark plug(s).

NOTE:

A flushing attachment is available from your Yamaha dealer.

EMU28410

Lubrication (oil injection models)

1. Grease the spark plug threads and install the spark plug(s) and torque to proper specification. For information on spark plug installation, see page 57.
2. Fill the oil tanks. This prevents the formation of condensation. For models with a remote oil tank, it may be necessary to manually override the control unit to completely fill the engine oil tank.
3. Change the gear oil. For instructions,

Maintenance

see page 63. Inspect the oil for the presence of water which indicates a leaky seal. Seal replacement should be performed by an authorized Yamaha dealer prior to use.

4. Grease all grease fittings. For further details, see page 57.

EMU28430

Battery care

EWM00330



Battery electrolytic fluid is dangerous; it contains sulfuric acid and therefore is poisonous and highly caustic.

Always follow these preventive measures:

- **Avoid bodily contact with electrolytic fluid as it can cause severe burns or permanent eye injury.**
- **Wear protective eye gear when handling or working near batteries.**

Antidote (EXTERNAL):

- **SKIN** - Flush with water.
- **EYES** - Flush with water for 15 minutes and get immediate medical attention.

Antidote (INTERNAL):

- **Drink large quantities of water or milk followed by milk of magnesia, beaten egg, or vegetable oil. Get immediate medical attention.**

Batteries also generate explosive hydrogen gas; therefore, you should always follow these preventive measures:

- **Charge batteries in a well-ventilated area.**
- **Keep batteries away from fire, sparks, or open flames (for example: welding equipment, lighted cigarettes, and so on.)**
- **DO NOT SMOKE** when charging or han-

dling batteries.

KEEP BATTERIES AND ELECTROLYTIC FLUID OUT OF REACH OF CHILDREN.

Batteries vary among manufacturers. Therefore the following procedures may not always apply. Consult your battery manufacturer's instructions.

Procedure

1. Disconnect and remove the battery from the boat. Always disconnect the black negative cable first to prevent the risk of shorting.
2. Clean the battery casing and terminals. Fill each cell to the upper level with distilled water.
3. Store the battery on a level surface in a cool, dry, well-ventilated place out of direct sunlight.
4. Once a month, check the specific gravity of the electrolyte and recharge as required to prolong battery life.

EMU28442

Flushing power unit

Perform this procedure right after operation for the most thorough flushing.

ECM01530

CAUTION:

Do not perform this procedure while the engine is running. The water pump may be damaged and severe damage from overheating can result.

1. After shutting off the engine, unscrew the garden hose connector from the fitting on the bottom cowling.

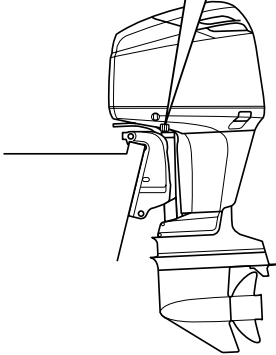
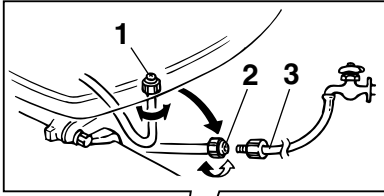

ZMU04723

1. Fitting
2. Garden hose connector
3. Garden hose adapter

2. Screw the garden hose adapter onto a garden hose, which is connected to a fresh water supply, and then connect it to the garden hose connector.
3. With the engine off, turn on the water tap and let the water flush through the cooling passages for about 15 minutes. Turn off the water and disconnect the garden hose adapter from the garden hose connector.
4. Reinstall the garden hose connector onto the fitting on the bottom cowling. Tighten the connector securely.

ECM00540

CAUTION:

Do not leave the garden hose connector loose on the bottom cowling fitting or let the hose hang free during normal opera-

tion. Water will leak out of the connector instead of cooling the engine, which can cause serious overheating. Be sure the connector is tightened securely on the fitting after flushing the engine.

NOTE:

- When flushing the engine with the boat in the water, tilting up the outboard motor until it is completely out of the water will achieve better results.
- For cooling system flushing instructions, see page 49.

EMU28450

Cleaning the outboard motor

After use, wash the exterior of the outboard motor with fresh water. Flush the cooling system with fresh water.

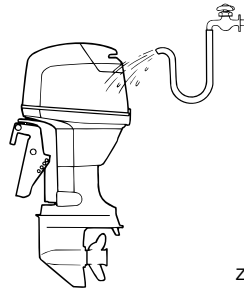

ZMU02550

NOTE:

For cooling system flushing instructions, see page 49.

EMU28460

Checking painted surface of motor

Check the motor for scratches, nicks, or flaking paint. Areas with damaged paint are more likely to corrode. If necessary, clean and paint the areas. A touch-up paint is available from your Yamaha dealer.

Maintenance

EMU28476

Periodic maintenance

EWM01070



Be sure to turn off the engine when you perform maintenance unless otherwise specified. If you or the owner is not familiar with machine servicing, this work should be done by your Yamaha dealer or other qualified mechanic.

EMU28510

Replacement parts

If replacement parts are necessary, use only genuine Yamaha parts or parts of the same type and of equivalent strength and materials. Any part of inferior quality may malfunction, and the resulting loss of control could endanger the operator and passengers. Yamaha genuine parts and accessories are available from your Yamaha dealer.

EMU28522

Maintenance chart

Frequency of maintenance operations may be adjusted according to the operating conditions, but the following table gives general guidelines. Refer to the sections in this chapter for explanations of each owner-specific action.

NOTE:

When operating in salt water, turbid or muddy water, the engine should be flushed with clean water after each use.

The “●” symbol indicates the check-ups which you may carry out yourself.

The “○” symbol indicates work to be carried out by your Yamaha dealer.

Item	Actions	Initial		Every	
		10 hours (1 month)	50 hours (3 months)	100 hours (6 months)	200 hours (1 year)
Anode(s) (external)	Inspection / replacement		●/○	●/○	
Anode(s) (internal)	Inspection / replacement				○
Battery	Inspection / charging	●/○			
Cooling water passages	Cleaning		●	●	
Cowling clamp	Inspection				●
Fuel filter (can be disassembled)	Inspection / replacement	●	●	●	
Fuel system	Inspection	●	●	●	
Gear oil	Change	●		●	
Greasing points	Greasing			●	
Idling speed	Inspection				○
PCV (Pressure Control Valve)	Inspection				○
Power trim and tilt unit	Inspection				○
Propeller and cotter pin	Inspection / replacement		●	●	
Shift link / shift cable	Inspection / adjustment				○
Thermostat	Inspection / replacement				○
Throttle link / throttle cable / throttle pick-up timing	Inspection / adjustment				○
Throttle position sensor	Inspection / adjustment				○

Maintenance

Item	Actions	Initial		Every	
		10 hours (1 month)	50 hours (3 months)	100 hours (6 months)	200 hours (1 year)
Water pump	Inspection / replacement				○
High pressure fuel pump drive belt	Inspection / replacement			○	○
High pressure fuel pump oil level	Inspection / filling				○
Oil pump	Inspection / adjustment	○			
Oil tank water drain	Inspection / cleaning	●/○	●/○	●/○	
Spark plug(s)	Cleaning / adjustment / replacement	●	●	●	

EMU28874

Maintenance chart (additional)

Item	Actions	Every	
		500 hours (2.5 years)	1000 hours (5 years)
High pressure fuel pump drive belt	Replacement		○
Fuel filter (vapor separator tank)	Replacement		○

EMU28940

Greasing

Yamaha grease A (water resistant grease)

Yamaha grease D (corrosion resistant grease; for propeller shaft)

Z150P, LZ150P, Z175G, Z200N, LZ200N

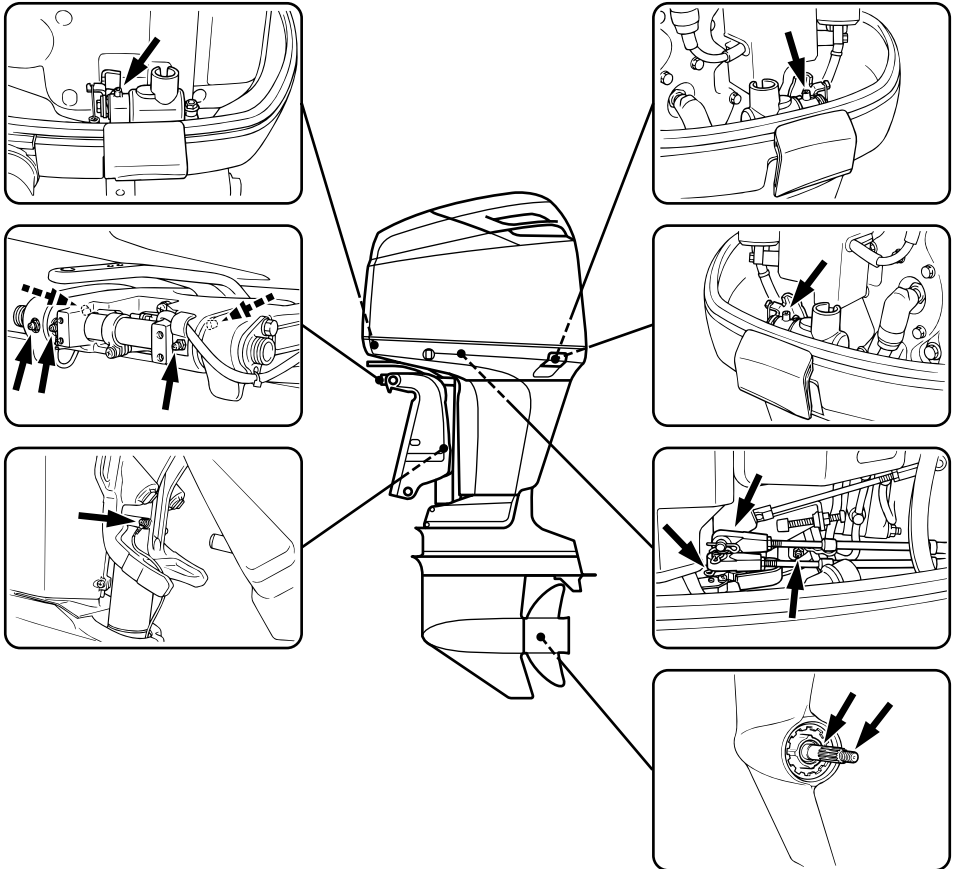

ZMU04724

EMU28952

Cleaning and adjusting spark plug

EWMO0560



WARNING

When removing or installing a spark plug, be careful not to damage the insulator. A

damaged insulator could allow external sparks, which could lead to explosion or fire.

The spark plug is an important engine component and is easy to inspect. The condition

Maintenance

of the spark plug can indicate something about the condition of the engine. For example, if the center electrode porcelain is very white, this could indicate an intake air leak or carburetion problem in that cylinder. Do not attempt to diagnose any problems yourself. Instead, take the outboard motor to a Yamaha dealer. You should periodically remove and inspect the spark plug because heat and deposits will cause the spark plug to slowly break down and erode. If electrode erosion becomes excessive, or if carbon and other deposits are excessive, you should replace the spark plug with another of the correct type.

Standard spark plug:

LZ150PETO BKR6EKU
LZ200NETO BKR7EKU
Z150PETO BKR6EKU
Z175GETO BKR7EKU
Z200NETO BKR7EKU

Before fitting the spark plug, measure the electrode gap with a wire thickness gauge; adjust the gap to specification if necessary.

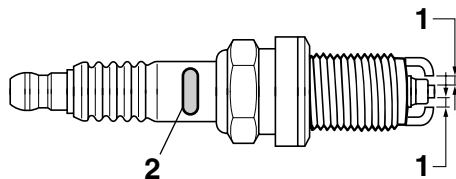

ZMU01892

1. Spark plug gap
2. Spark plug I.D. mark (NGK)

Spark plug gap:

1.5–1.6 mm (0.059–0.063 in)

When fitting the plug, always clean the gasket surface and use a new gasket. Wipe off any dirt from the threads and screw in the spark plug to the correct torque.

Spark plug torque:

25.0 Nm (18.4 ft-lb) (2.55 kgf-m)

NOTE:

If a torque-wrench is not available when you are fitting a spark plug, a good estimate of the correct torque is 1/4 to 1/2 a turn past finger-tight. Have the spark plug adjusted to the correct torque as soon as possible with a torque-wrench.

EMU28962

Checking fuel system

EWM00060



WARNING

Gasoline and its vapors are highly flammable and explosive. Keep away from sparks, cigarettes, flames, or other sources of ignition.

EWM00910



WARNING

Leaking fuel can result in fire or explosion.

- Check for fuel leakage regularly.
- If any fuel leakage is found, the fuel system must be repaired by a qualified mechanic. Improper repairs can make the outboard unsafe to operate.

Check the fuel lines for leaks, crack, or malfunction. If a problem is found, your Yamaha dealer or other qualified mechanic should repair it immediately.

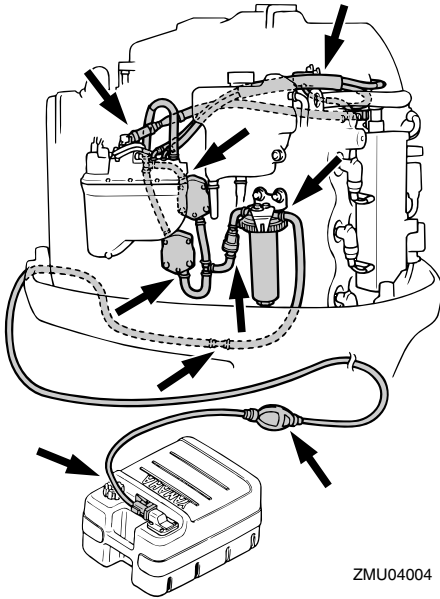

Checkpoints

- Fuel system parts leakage
- Fuel line joint leakage
- Fuel line cracks or other damage
- Fuel connector leakage

EMU29041

Inspecting idling speed

EWM00451

WARNING

- Do not touch or remove electrical parts when starting or during operation.
- Keep hands, hair, and clothes away from the flywheel and other rotating parts while the engine is running.

ECM00490

CAUTION:

This procedure must be performed while the outboard motor is in the water. A flushing attachment or test tank can be used.

A diagnostic tachometer should be used for

this procedure. Results may vary depending on whether testing is conducted with the flushing attachment, in a test tank, or with the outboard motor in the water.

1. Start the engine and allow it to warm up fully in neutral until it is running smoothly.

NOTE:

Correct idling speed inspection is only possible if the engine is fully warmed up. If not warmed up fully, the idle speed will measure higher than normal. If you have difficulty verifying the idle speed, or the idle speed requires adjustment, consult a Yamaha dealer or other qualified mechanic.

2. Verify whether the idle speed is set to specification. For idle speed specifications, see page 48.

EMU29050

Checking water in engine oil tank

Oil injection models

There is a water trap at the bottom of the engine oil tank. If water or foreign matter is visible in this trap, consult your Yamaha dealer.

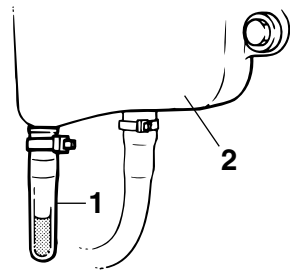

1. Water trap
2. Engine oil tank

EMU29112

Checking wiring and connectors

- Check that each grounding wire is properly secured.

Maintenance

- Check that each connector is engaged securely.

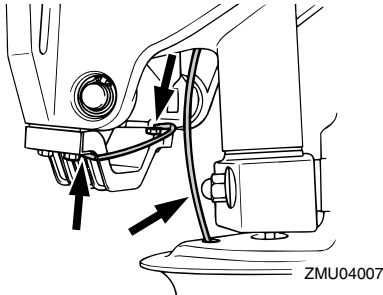

EMU29120

Exhaust leakage

Start the engine and check that no exhaust leaks from the joints between the exhaust cover, cylinder head, and body cylinder.

EMU29130

Water leakage

Start the engine and check that no water leaks from the joints between the exhaust cover, cylinder head, and body cylinder.

EMU29153

Checking power trim and tilt system

EWM00430

⚠ WARNING

- **Never get under the lower unit while it is tilted, even when the tilt support lever is locked. Severe injury could occur if the outboard motor accidentally falls.**
- **Make sure no one is under the outboard motor before performing this test.**

1. Check the power trim and tilt unit for any sign of oil leaks.
2. Operate each of the power trim and tilt switches on the remote control and engine bottom cowling (if equipped) to check that all switches work.
3. Tilt the outboard motor up and check that the tilt rod and trim rods are extended completely.

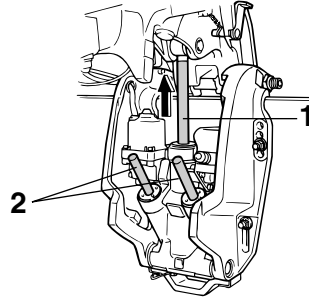

ZMU03458

1. Tilt rod
2. Trim rods

4. Use the tilt support lever to lock the motor in the up position. Operate the tilt down switch briefly so the motor is supported by the tilt support lever.

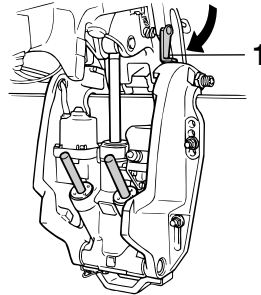

ZMU04155

1. Tilt support lever
5. Check that the tilt rod and trim rods are free of corrosion or other flaws.
6. Activate the tilt-down switch until the trim rods have retracted completely into the cylinders.

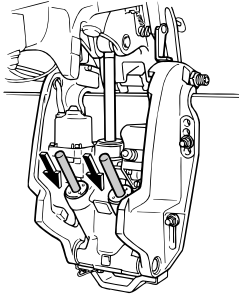

ZMU04156

7. Activate the trim-up switch until the tilt rod is fully extended. Unlock the tilt support lever.

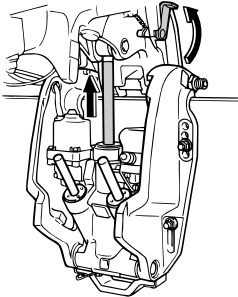

ZMU03460

8. Tilt the outboard motor down. Check that the tilt rod and trim rods operate smoothly.

NOTE:

Consult your Yamaha dealer if any operation is abnormal.

EMU29171

Checking propeller

EWM00321

WARNING

You could be seriously injured if the engine accidentally starts when you are near the propeller.

- Before inspecting, removing, or installing the propeller, remove the spark plug caps from the spark plugs. Also, place the shift control in neutral, turn

the main switch to “OFF” (off) and remove the key, and remove the lanyard from the engine stop switch. Turn off the battery cut-off switch if your boat has one.

- Do not use your hand to hold the propeller when loosening or tightening the propeller nut. Put a wood block between the anti-cavitation plate and the propeller to prevent the propeller from turning.

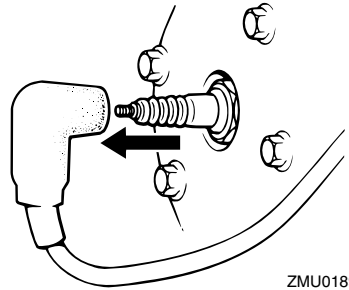

ZMU01896

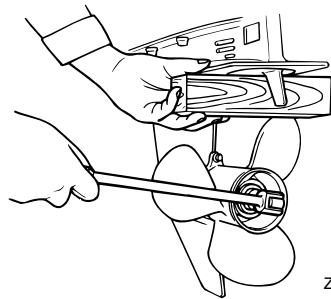

ZMU01897

Checkpoints

- Check each of the propeller blades for wear, erosion from cavitation or ventilation, or other damage.
- Check the propeller shaft for damage.
- Check the splines / shear pin for wear or damage.
- Check for fish line tangled around the propeller shaft.

Maintenance

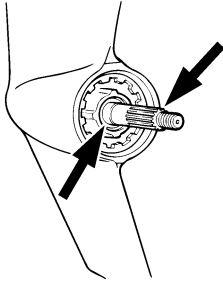

ZMU01803

- Check the propeller shaft oil seal for damage.

NOTE:

If the shear pin equipped: it is designed to break if the propeller hits a hard underwater obstacle to help protect the propeller and drive mechanism. The propeller will then spin freely on the shaft. If this happens, the shear pin must be replaced.

EMU30660

Removing the propeller

EMU29194

Spline models

1. Straighten the cotter pin and pull it out using a pair of pliers.
2. Remove the propeller nut, washer, and spacer (if equipped).

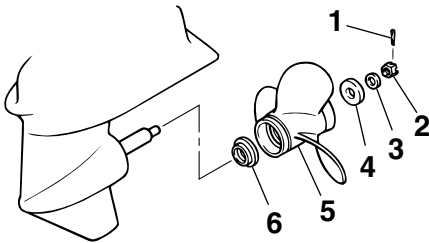

ZMU01898

1. Cotter pin
2. Propeller nut
3. Washer
4. Spacer

5. Propeller
6. Thrust washer

3. Remove the propeller and thrust washer.

EMU30670

Installing the Propeller

EMU29242

Spline models

EWM00770



On counter rotation models, be sure to use a propeller intended for counter-clockwise rotation. These propellers are identified with the letter "L" after the size indication on the propeller. Otherwise the boat could move in the opposite direction from that expected.

ECM00340

CAUTION:

- Be sure to install the thrust washer before installing the propeller, otherwise the lower case and propeller boss could be damaged.
- Be sure to use a new cotter pin and bend the ends over securely. Otherwise the propeller could come off during operation and be lost.

1. Apply Yamaha marine grease or a corrosion resistant grease to the propeller shaft.
2. Install the thrust washer and propeller on the propeller shaft.
3. Install the spacer and washer. Tighten the propeller nut to the specified torque.

Propeller nut tightening torque:
55.0 Nm (40.6 ft-lb) (5.61 kgf-m)

4. Align the propeller nut with the propeller shaft hole. Insert a new cotter pin in the hole and bend the cotter pin ends.

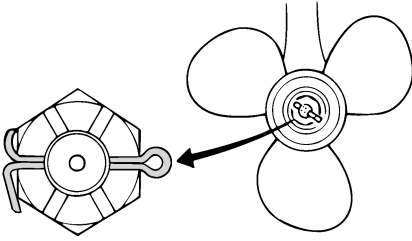

ZMU01805

NOTE:

If the propeller nut does not align with the propeller shaft hole after tightening to the specified torque, tighten the nut further to align it with the hole.

EMU29282

Changing gear oil

EWM00800

WARNING

- Be sure the outboard motor is securely fastened to the transom or a stable stand. You could be severely injured if the outboard motor falls on you.
- Never get under the lower unit while it is tilted, even when the tilt support lever or knob is locked. Severe injury could occur if the outboard motor accidentally falls.

1. Tilt the outboard motor so that the gear oil drain screw is at the lowest point possible.
2. Place a suitable container under the gear case.
3. Remove the gear oil drain screw and gasket.

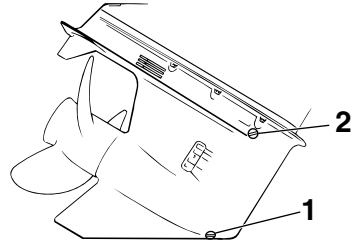

ZMU01899

1. Gear oil drain screw
2. Oil level plug

NOTE:

- If a magnetic gear oil drain screw is equipped, remove all metal particles from the screw before installing it.
- Always use new gaskets. Do not reuse the removed gaskets.

4. Remove the oil level plug and gasket to allow the oil to drain completely.

ECM00710

CAUTION:

Inspect the used oil after it has been drained. If the oil is milky, water is getting into the gear case which can cause gear damage. Consult a Yamaha dealer for repair of the lower unit seals.

NOTE:

For disposal of used oil, consult your Yamaha dealer.

5. With the outboard motor in a vertical position, and using a flexible or pressurized filling device, inject the gear oil into

Maintenance

the gear oil drain screw hole.

Recommended gear oil:

Hypoid gear oil SAE#90

Gear oil quantity:

LZ150PETO 870.0 cm³ (29.41 US oz)
(30.68 Imp.oz)

LZ200NETO 870.0 cm³ (29.41 US oz)
(30.68 Imp.oz)

Z150PETO 980.0 cm³ (33.13 US oz)
(34.56 Imp.oz)

Z175GETO 980.0 cm³ (33.13 US oz)
(34.56 Imp.oz)

Z200NETO 980.0 cm³ (33.13 US oz)
(34.56 Imp.oz)

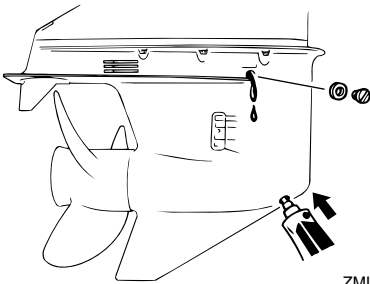

ZMU01900

- Put a new gasket on the oil level plug. When the oil begins to flow out of the oil level plug hole, insert and tighten the oil level plug.
- Put a new gasket on the gear oil drain screw. Insert and tighten the gear oil drain screw.

EMU29312

Inspecting and replacing anode(s)

Yamaha outboard motors are protected from corrosion by sacrificial anodes. Inspect the external anodes periodically. Remove scales from the surfaces of the anodes. Consult a Yamaha dealer for replacement of external

anodes.

ECM00720

CAUTION:

Do not paint anodes, as this would render them ineffective.

NOTE:

Inspect ground leads attached to external anodes on equipped models. Consult a Yamaha dealer for inspection and replacement of internal anodes attached to the power unit.

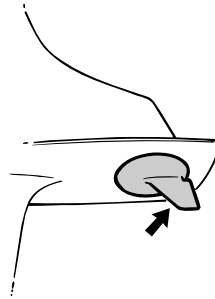

ZMU01901

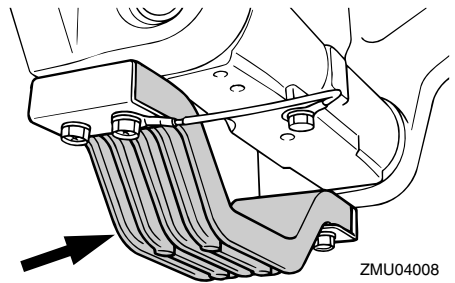

ZMU04008

EMU29320

Checking battery (for electric start models)

EWM00330

WARNING

Battery electrolytic fluid is dangerous; it contains sulfuric acid and therefore is poisonous and highly caustic.

Always follow these preventive mea-

asures:

- Avoid bodily contact with electrolytic fluid as it can cause severe burns or permanent eye injury.
- Wear protective eye gear when handling or working near batteries.

Antidote (EXTERNAL):

- SKIN - Flush with water.
- EYES - Flush with water for 15 minutes and get immediate medical attention.

Antidote (INTERNAL):

- Drink large quantities of water or milk followed by milk of magnesia, beaten egg, or vegetable oil. Get immediate medical attention.

Batteries also generate explosive hydrogen gas; therefore, you should always follow these preventive measures:

- Charge batteries in a well-ventilated area.
- Keep batteries away from fire, sparks, or open flames (for example: welding equipment, lighted cigarettes, and so on.)
- DO NOT SMOKE when charging or handling batteries.

KEEP BATTERIES AND ELECTROLYTIC FLUID OUT OF REACH OF CHILDREN.

ECM00360

CAUTION:

- A poorly maintained battery will quickly deteriorate.
- Ordinary tap water contains minerals harmful to a battery, and should not be used for topping up.

1. Check the electrolyte level at least once a month. Fill to the manufacturer's recommended level when necessary. Top up only with distilled water (or pure de-ionized water suitable to use in batter-

ies).

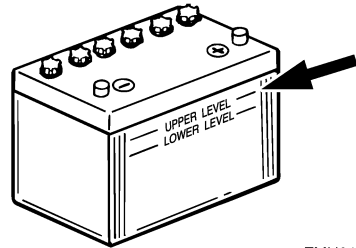

ZMU01810

2. Always keep the battery in a good state of charge. Installing a voltmeter will help you monitor your battery. If you will not use the boat for a month or more, remove the battery from the boat and store it in a cool, dark place. Completely recharge the battery before using it.
3. If the battery will be stored for longer than a month, check the specific gravity of the fluid at least once a month and recharge the battery when it is low.

NOTE:

Consult a Yamaha dealer when charging or re-charging batteries.

EMU29351

Connecting the Battery

EWM00570

WARNING

Mount the battery holder securely in a dry, well-ventilated, vibration-free location in the boat. Install a fully charged battery in the holder.

ECM01121

CAUTION:

- Make sure the main switch (on applicable models) is "OFF" (off) before working on the battery.
- Reversal of the battery cables will dam-

Maintenance

age the electrical parts.

- Connect the red battery cable first when installing the battery and disconnect the black battery cable first when removing it. Otherwise, the electrical parts can be damaged.
- The electrical contacts of the battery and cables must be clean and properly connected, or the battery will not start the engine.

Connect the RED lead to the POSITIVE (+) terminal first. Then connect the BLACK lead to the NEGATIVE (-) terminal.

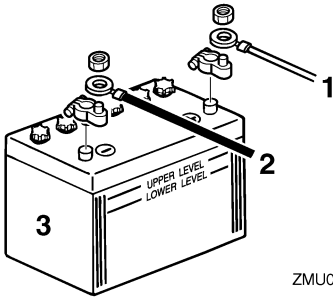

ZMU04407

1. Red cable
2. Black cable
3. Battery

Using an accessory battery (option)

Use a connecting cable between the (-) terminals of the starting battery and accessory battery. See the illustrations of the wiring connections. This cable must be made from wire equivalent to the starting battery cable.

EWM00600



WARNING

Use of smaller wire could lead to a fire.

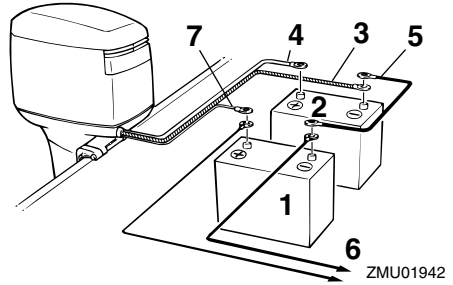

1. Battery for accessories
2. Battery for starting
3. Large black lead
4. Large red lead for starting battery
5. Negative connecting cable
6. Power for accessories
7. Small red lead for accessory battery charging (optional part)

NOTE:

If a battery selector switch is desired, consult your YAMAHA dealer about correct wiring.

EMU29370

Disconnecting the battery

Disconnect the BLACK cable from the NEGATIVE (-) terminal first. Then disconnect the RED cable from the POSITIVE (+) terminal.

EMU29390

Checking top cowling

Check the fitting of the top cowling by pushing it with both hands. If it is loose have it repaired by your Yamaha dealer.

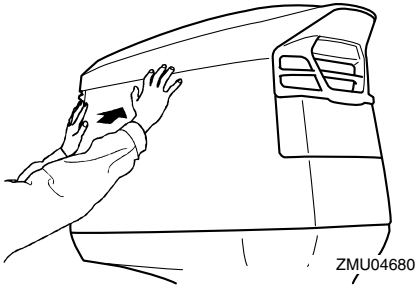

ZMU04680

EMU29400

Coating the boat bottom

A clean hull improves boat performance. The boat bottom should be kept as clean of marine growth as possible. If necessary, the boat bottom can be coated with an anti-fouling paint approved for your area to inhibit marine growth.

Do not use anti-fouling paint which includes copper or graphite. These paints can cause more rapid engine corrosion.

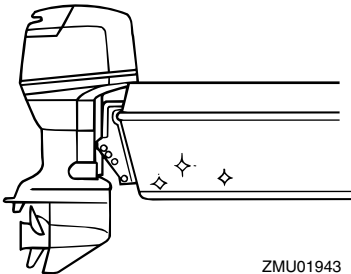

ZMU01943

Trouble Recovery

EMU29424

Troubleshooting

A problem in the fuel, compression, or ignition systems can cause poor starting, loss of power, or other problems. This section describes basic checks and possible remedies, and covers all Yamaha outboard motors. Therefore some items may not apply to your model.

If your outboard motor requires repair, bring it to your Yamaha dealer.

If the engine trouble warning indicator is flashing, consult your Yamaha dealer.

Starter will not operate.

Q. Is battery capacity weak or low?

A. Check battery condition. Use battery of recommended capacity.

Q. Are battery connections loose or corroded?

A. Tighten battery cables and clean battery terminals.

Q. Is fuse for electric start relay or electric circuit blown?

A. Check for cause of electric overload and repair. Replace fuse with one of correct amperage.

Q. Are starter components faulty?

A. Have serviced by a Yamaha dealer.

Q. Is shift lever in gear?

A. Shift to neutral.

Engine will not start (starter operates).

Q. Is fuel tank empty?

A. Fill tank with clean, fresh fuel.

Q. Is fuel contaminated or stale?

A. Fill tank with clean, fresh fuel.

Q. Is fuel filter clogged?

A. Clean or replace filter.

Q. Is starting procedure incorrect?

A. See page 37.

Q. Has fuel pump malfunctioned?

A. Have serviced by a Yamaha dealer.

Q. Are spark plug(s) fouled or of incorrect type?

A. Inspect spark plug(s). Clean or replace with recommended type.

Q. Are spark plug cap(s) fitted incorrectly?

A. Check and re-fit cap(s).

Q. Is ignition wiring damaged or poorly connected?

A. Check wires for wear or breaks. Tighten all loose connections. Replace worn or broken wires.

Q. Are ignition parts faulty?

A. Have serviced by a Yamaha dealer.

Q. Is engine stop switch lanyard not attached?

A. Attach lanyard.

Q. Are engine inner parts damaged?

A. Have serviced by a Yamaha dealer.

Engine idles irregularly or stalls.

Q. Are spark plug(s) fouled or of incorrect type?

A. Inspect spark plug(s). Clean or replace with recommended type.

Trouble Recovery

Q. Is fuel system obstructed?

A. Check for pinched or kinked fuel line or other obstructions in fuel system.

Q. Is fuel contaminated or stale?

A. Fill tank with clean, fresh fuel.

Q. Is fuel filter clogged?

A. Clean or replace filter.

Q. Have ignition parts failed?

A. Have serviced by a Yamaha dealer.

Q. Has warning system activated?

A. Find and correct cause of warning.

Q. Is spark plug gap incorrect?

A. Inspect and adjust as specified.

Q. Is ignition wiring damaged or poorly connected?

A. Check wires for wear or breaks. Tighten all loose connections. Replace worn or broken wires.

Q. Is specified engine oil not being used?

A. Check and replace oil as specified.

Q. Is thermostat faulty or clogged?

A. Have serviced by a Yamaha dealer.

Q. Are carburetor adjustments incorrect?

A. Have serviced by a Yamaha dealer.

Q. Is fuel pump damaged?

A. Have serviced by a Yamaha dealer.

Q. Is air vent screw on fuel tank closed?

A. Open air vent screw.

Q. Is choke knob pulled out?

A. Return to home position.

Q. Is motor angle too high?

A. Return to normal operating position.

Q. Is carburetor clogged?

A. Have serviced by a Yamaha dealer.

Q. Is fuel joint connection incorrect?

A. Connect correctly.

Q. Is throttle valve adjustment incorrect?

A. Have serviced by a Yamaha dealer.

Q. Is battery cable disconnected?

A. Connect securely.

Warning buzzer sounds or indicator lights.

Q. Is cooling system clogged?

A. Check water intake for restriction.

Q. Is engine oil level low?

A. Fill oil tank with specified engine oil.

Q. Is heat range of spark plug incorrect?

A. Inspect spark plug and replace it with recommended type.

Q. Is specified engine oil not being used?

A. Check and replace oil with specified type.

Q. Is engine oil contaminated or deteriorated?

A. Replace oil with fresh, specified type.

Q. Is oil filter clogged?

A. Have serviced by a Yamaha dealer.

Q. Has oil feed/injection pump malfunctioned?

Trouble Recovery

A. Have serviced by a Yamaha dealer.

Q. Is load on boat improperly distributed?

A. Distribute load to place boat on an even plane.

Q. Is water pump or thermostat faulty?

A. Have serviced by a Yamaha dealer.

Q. Is there excess water in fuel filter cup?

A. Drain filter cup.

Engine power loss.

Q. Is propeller damaged?

A. Have propeller repaired or replaced.

Q. Is propeller pitch or diameter incorrect?

A. Install correct propeller to operate outboard at its recommended speed (r/min) range.

Q. Is trim angle incorrect?

A. Adjust trim angle to achieve most efficient operation.

Q. Is motor mounted at incorrect height on transom?

A. Have motor adjusted to proper transom height.

Q. Has warning system activated?

A. Find and correct cause of warning.

Q. Is boat bottom fouled with marine growth?

A. Clean boat bottom.

Q. Are spark plug(s) fouled or of incorrect type?

A. Inspect spark plug(s). Clean or replace with recommended type.

Q. Are weeds or other foreign matter tangled on gear housing?

A. Remove foreign matter and clean lower unit.

Q. Is fuel system obstructed?

A. Check for pinched or kinked fuel line or other obstructions in fuel system.

Q. Is fuel filter clogged?

A. Clean or replace filter.

Q. Is fuel contaminated or stale?

A. Fill tank with clean, fresh fuel.

Q. Is spark plug gap incorrect?

A. Inspect and adjust as specified.

Q. Is ignition wiring damaged or poorly connected?

A. Check wires for wear or breaks. Tighten all loose connections. Replace worn or broken wires.

Q. Have electrical parts failed?

A. Have serviced by a Yamaha dealer.

Q. Is specified fuel not being used?

A. Replace fuel with specified type.

Q. Is specified engine oil not being used?

A. Check and replace oil with specified type.

Q. Is thermostat faulty or clogged?

A. Have serviced by a Yamaha dealer.

Q. Is air vent screw closed?

A. Open the air vent screw.

Q. Is fuel pump damaged?

A. Have serviced by a Yamaha dealer.

Trouble Recovery

Q. Is fuel joint connection incorrect?

A. Connect correctly.

Q. Is heat range of spark plug incorrect?

A. Inspect spark plug and replace it with recommended type.

Q. Is high pressure fuel pump drive belt broken?

A. Have serviced by a Yamaha dealer.

Q. Is engine not responding properly to shift lever position?

A. Have serviced by a Yamaha dealer.

Engine vibrates excessively.

Q. Is propeller damaged?

A. Have propeller repaired or replaced.

Q. Is propeller shaft damaged?

A. Have serviced by a Yamaha dealer.

Q. Are weeds or other foreign matter tangled on propeller?

A. Remove and clean propeller.

Q. Is motor mounting bolt loose?

A. Tighten bolt.

Q. Is steering pivot loose or damaged?

A. Tighten or have serviced by a Yamaha dealer.

EMU29433

Temporary action in emergency

EMU29440

Impact damage

EWM00870



WARNING

The outboard motor can be seriously

damaged by a collision while operating or trailering. Damage could make the outboard motor unsafe to operate.

If the outboard motor hits an object in the water, follow the procedure below.



1. Stop the engine immediately.
2. Inspect the control system and all components for damage. Also inspect the boat for damage.
3. Whether damage is found or not, return to the nearest harbor slowly and carefully.
4. Have a Yamaha dealer inspect the outboard motor before operating it again.

EMU29450

Running single engine

When using only engine in an emergency, be sure to keep the unused one tilted up and operate the other engine at low speed.

ECM00370

CAUTION:

If the boat is operated with one engine in the water but not running, water may run into the exhaust pipe due to wave action, causing engine trouble.

NOTE:

When you are maneuvering at low speed, such as near a dock, it is recommended that both engines be running with one in neutral gear if possible.

Trouble Recovery

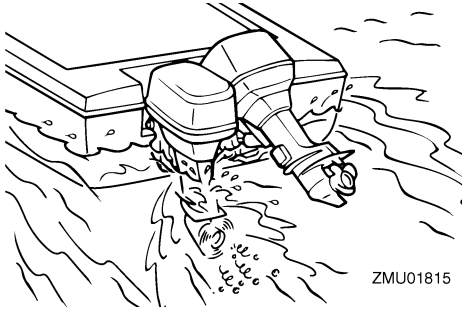

EMU29492

Replacing fuse

If the fuse has blown on an electric start model, open the fuse box and use a fuse puller to replace the fuse with a spare one of the proper amperage.

EWM00630

WARNING

Be sure to use the specified fuse. An incorrect fuse or a piece of wire could allow excessive current flow. This could cause electric system damage and a fire hazard.

ECM01382

CAUTION:

- If a main fuse has blown, be sure to also check the other main fuse.
- If the outboard motor is operated after a main fuse has blown charging capability will be insufficient, and the engine will not start.

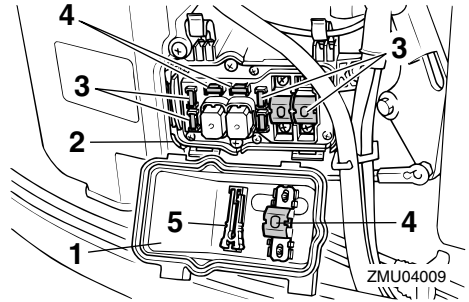

1. Electrical cover
2. Fuse holder
3. Fuse (20 A × 3, 30 A, 80 A × 2)
4. Spare fuse (20 A, 30 A, 80 A)
5. Fuse puller

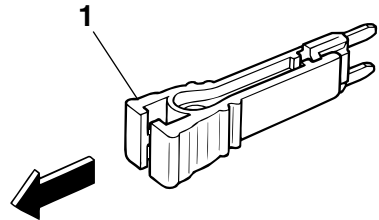

1. Fuse puller

NOTE:

Consult your Yamaha dealer if the new fuse immediately blows again.

EMU29522

Power trim and tilt / power tilt will not operate

If the engine cannot be tilted up or down with the power trim and tilt / the power tilt because of a discharged battery or a failure with the power trim and tilt unit / the power tilt unit, the engine can be tilted manually.

1. Loosen the manual valve screw by turning it counterclockwise until it stops.

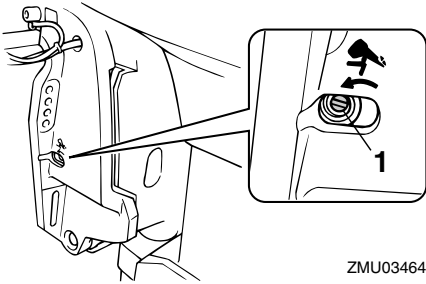

ZMU03464

1. Manual valve screw
2. Put the engine in the desired position, then tighten the manual valve screw by turning it clockwise.

EMU31780

Water separator warning indicator blinks while cruising

EWM01500

WARNING

Gasoline is highly flammable, and its vapors are flammable and explosive.

- Do not perform this procedure on a hot or running engine. Allow the engine to cool.
- There will be fuel in the fuel filter. Keep away from sparks, cigarettes, flames or other sources of ignition.
- This procedure will allow some fuel to spill. Catch fuel in a rag. Wipe up any spilled fuel immediately.
- The fuel filter must be reassembled carefully with the O-ring, filter cup, and hoses in place. Improper assembly or replacement could result in a fuel leak, which could result in a fire or explosion hazard.

If the water separator warning indicator on the tachometer blinks, perform the following procedure.

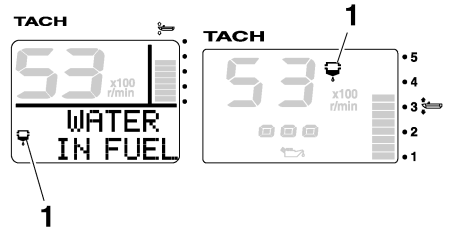

ZMU05442

1. Water separator warning indicator

1. Stop the engine.
2. Remove the top cowling.
3. Disconnect the water detection switch coupler.

ECM01570

CAUTION:

Be careful not to get any water on the water detection switch coupler, otherwise a malfunction could occur.

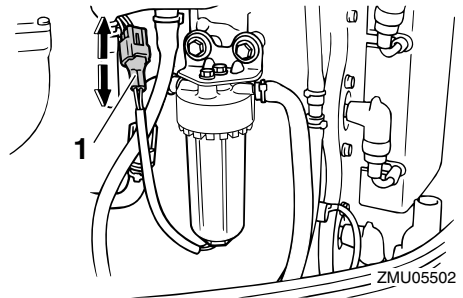

ZMU05502

1. Water detection switch coupler
4. Unscrew the filter cup from the filter housing.

NOTE:

Be careful not to twist the water detection switch lead when unscrewing the filter cup.

Trouble Recovery

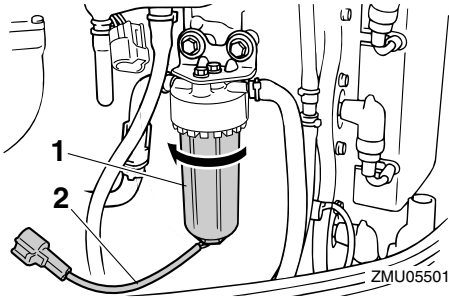

1. Filter cup
2. Water detection switch lead

5. Drain the water in the filter cup by soaking it up with a rag.

NOTE: _____

Properly dispose of the rag.

6. Firmly screw the filter cup onto the filter housing.

NOTE: _____

Be careful not to twist the water detection switch lead when screwing the filter cup onto the filter housing.

7. Connect the water detection switch coupler securely until a click is heard.

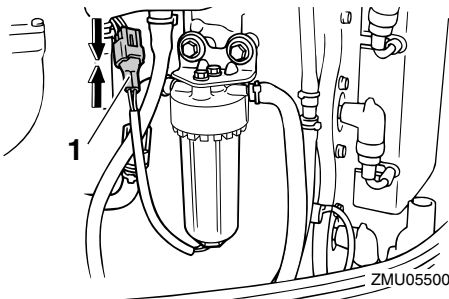

1. Water detection switch coupler

8. Install the top cowling.
9. Start the engine and make sure that the water separator warning indicator re-

mains off.

NOTE: _____

Have a Yamaha dealer inspect the outboard motor after returning to port.

EMU29541

Starter will not operate

If the starter mechanism does not operate (the engine cannot be cranked with the starter), the engine can be started manually with an emergency starter rope. However, the engine cannot be started manually if the battery voltage is low. If the battery is discharged to 9 volts or below, the electric fuel pump will not operate.

EWM01021

WARNING _____

- Use this procedure only in an emergency to return to the nearest port for repairs.
- When the emergency starter rope is used to start the engine, the start-in-gear protection device does not operate. Make sure the remote control lever is in neutral. Otherwise the boat could unexpectedly start to move, which could result in an accident.
- Attach the engine stop switch lanyard to a secure place on your clothing, or your arm or leg while operating the boat.
- Do not attach the lanyard to clothing that could tear loose. Do not route the cord where it could become entangled, preventing it from functioning.
- Avoid accidentally pulling the lanyard during normal operation. Loss of engine power means the loss of most steering control. Also, without engine power, the boat could slow rapidly. This could cause people and objects in the

boat to be thrown forward.

- Make sure no one is standing behind you when pulling the starter rope. It could whip behind you and injure someone.
- An unguarded, rotating flywheel is very dangerous. Keep loose clothing and other objects away when starting the engine. Use the emergency starter rope only as instructed. Do not touch the flywheel or other moving parts when the engine is running. Do not install the starter mechanism or top cowling after the engine is running.
- Do not touch the ignition coil, spark plug wire, spark plug cap, or other electrical components when starting or operating the motor. You could get an electrical shock.

EMU29581

Emergency starting engine

1. Remove the top cowling.
2. Remove the flywheel cover.

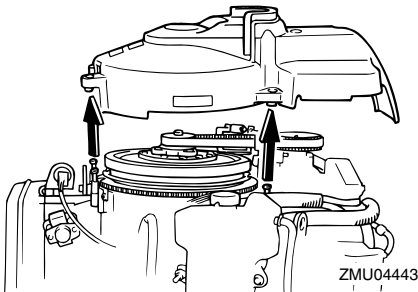

3. Prepare the engine for starting. For further information, see page 37. Be sure the engine is in neutral and that the engine stop switch lanyard lock plate is attached to the engine stop switch.

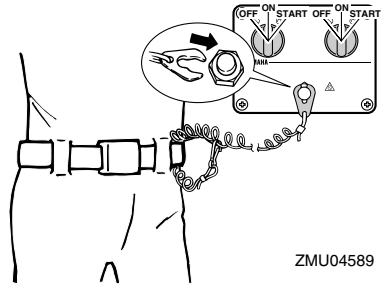
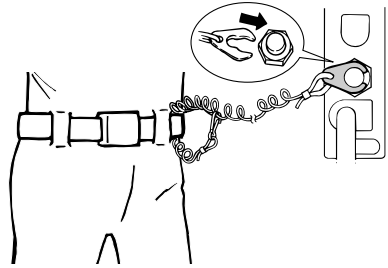

4. Turn on the main switch.

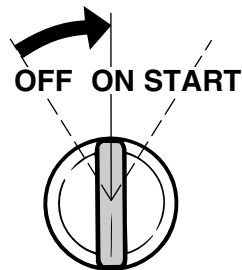

5. Insert the knotted end of the emergency starter rope into the notch in the flywheel rotor and wind the rope around the flywheel several turns clockwise.

Trouble Recovery

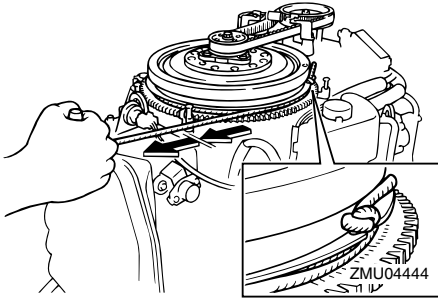

6. Give a strong pull straight out to crank the engine. Repeat if necessary.

EWMM00620



WARNING

Do not install the top cowlings when engine is running.

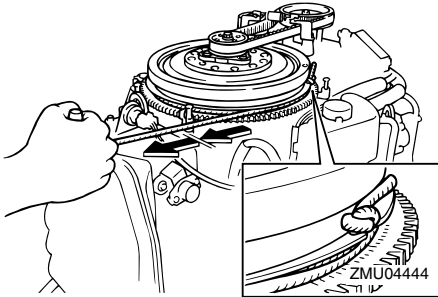

EMU29670

Engine fails to operate

EMU29741

Low oil level warning activates

If the oil level is allowed to drop too low, the red segment will appear on the oil level indicator, the buzzer will sound, and engine speed will be limited to about 2000 r/min. If this happens, a reserve amount of oil can be pumped from the remote oil tank to the engine oil tank using the emergency switch.

EWMM01050



WARNING

Be sure to stop the engine before per-

forming this procedure.

ECM00900

CAUTION:

- If the emergency switch is held up too long, too much oil will be pumped into the engine oil tank, overflowing it. Release the switch when oil reaches the upper level line on the engine oil tank.
- Do not use this emergency procedure unless the oil level warning indicators are working.

1. Remove the top cowlings.
2. Turn on the main switch.

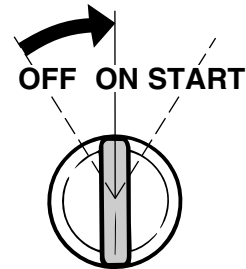

ZMU01906

3. Lift the emergency switch to pump reserve oil into the engine oil tank from the remote oil tank.

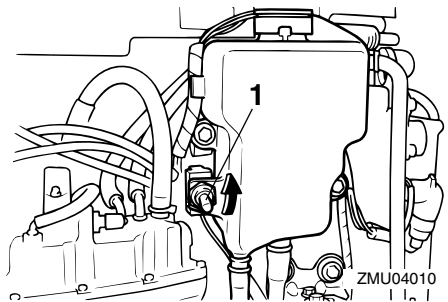

1. Emergency switch

Trouble Recovery

weed, and so on, with fresh water.

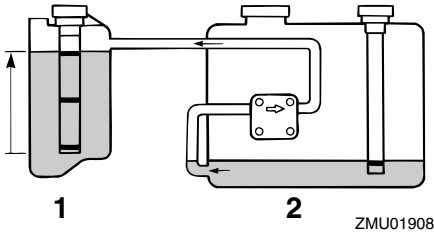

1. Engine oil tank
2. Remote oil tank

4. After using the emergency switch, turn off the main switch, then turn it back on. This resets the warning system to normal operation. The yellow segment will continue to be displayed on the oil level indicator.
5. Start the engine and return to the nearest port for more oil.

NOTE:

- The maximum reserve oil capacity is 1500 cm³ (1.6 US qt, 1.31 Imp qt).
- The oil-feed pump will not operate if the engine is tilted up more than 35°. Put the engine in the upright position (not tilted) before using the emergency switch.

EMU29760

Treatment of submerged motor

If the outboard motor is submerged, immediately take it to a Yamaha dealer. Otherwise some corrosion may begin almost immediately.

If you cannot immediately take the outboard motor to a Yamaha dealer, follow the procedure below in order to minimize engine damage.

EMU29790

Procedure

1. Thoroughly wash away mud, salt, sea-



2. Remove the spark plugs and face the spark plug holes downward to allow any water, mud, or contaminants to drain.

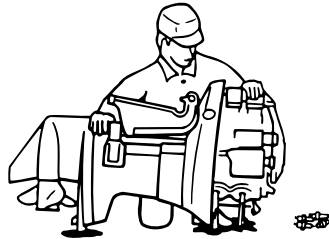

3. Drain the fuel from the vapor separator, fuel filter, and fuel line.
4. Feed fogging oil or engine oil through the intake manifold and spark plug holes while cranking with the emergency starter rope.

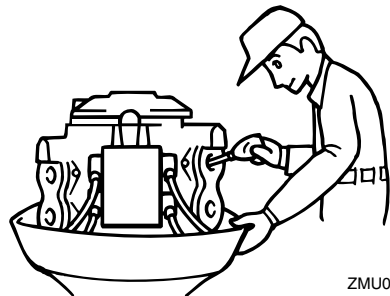

Trouble Recovery

5. Take the outboard motor to a Yamaha dealer as soon as possible.

ECM00400

CAUTION: _____

Do not attempt to run the outboard motor until it has been completely inspected.



YAMAHA MOTOR CO., LTD.

Printed in Japan

April 2006-0.1 × 1 

Printed on recycled paper