



YAMAHA



75C 90A

OWNER'S MANUAL

▲ Read this manual carefully before operating this outboard motor.

67P-28199-76-E0

EMU25052

Read this manual carefully before operating this outboard motor. Keep this manual onboard in a waterproof bag when boating. This manual should stay with the outboard motor if it is sold.

Important manual information

EMU25107

To the owner

Thank you for selecting a Yamaha outboard motor. This Owner's Manual contains information needed for proper operation, maintenance and care. A thorough understanding of these simple instructions will help you obtain maximum enjoyment from your new Yamaha. If you have any question about the operation or maintenance of your outboard motor, please consult a Yamaha dealer.

In this Owner's Manual particularly important information is distinguished in the following ways.

 : This is the safety alert symbol. It is used to alert you to potential personal injury hazards. Obey all safety messages that follow this symbol to avoid possible injury or death.

EWM00781

WARNING

A WARNING indicates a hazardous situation which, if not avoided, could result in death or serious injury.

ECM00701

NOTICE

A NOTICE indicates special precautions that must be taken to avoid damage to the outboard motor or other property.

TIP:

A TIP provides key information to make procedures easier or clearer.

Yamaha continually seeks advancements in product design and quality. Therefore, while this manual contains the most current product information available at the time of printing, there may be minor discrepancies between your machine and this manual. If

there is any question concerning this manual, please consult your Yamaha dealer.

To ensure long product life, Yamaha recommends that you use the product and perform the specified periodic inspections and maintenance by correctly following the instructions in the owner's manual. Any damage resulting from neglect of these instructions is not covered by warranty.

Some countries have laws or regulations restricting users from taking the product out of the country where it was purchased, and it may be impossible to register the product in the destination country. Additionally, the warranty may not apply in certain regions. When planning to take the product to another country, consult the dealer where the product was purchased for further information.

If the product was purchased used, please consult your closest dealer for customer re-registration, and to be eligible for the specified services.

TIP:

The 75CETO, 90AETO and the standard accessories are used as a base for the explanations and illustrations in this manual. Therefore some items may not apply to every model.

EMU25121

**75C, 90A
OWNER'S MANUAL**
©2010 by Yamaha Motor Co., Ltd.
1st Edition, March 2010
All rights reserved.
Any reprinting or unauthorized use
without the written permission of
Yamaha Motor Co., Ltd.
is expressly prohibited.
Printed in Japan

Table of contents

Safety information	1	Fuel requirements.....	12
Outboard motor safety	1	Gasoline	12
Propeller.....	1	Muddy or acidic water.....	12
Rotating parts.....	1	Anti-fouling paint.....	12
Hot parts	1	Motor disposal requirements.....	12
Electric shock.....	1	Emergency equipment.....	12
Power trim and tilt	1	Components	14
Engine shut-off cord (lanyard).....	1	Components diagram.....	14
Gasoline.....	1	Fuel tank	14
Gasoline exposure and spills	2	Fuel joint.....	15
Carbon monoxide.....	2	Fuel gauge	15
Modifications	2	Fuel tank cap.....	15
Boating safety	2	Air vent screw.....	15
Alcohol and drugs	2	Remote control box	15
Personal flotation devices	2	Remote control lever	15
People in the water	2	Neutral interlock trigger	16
Passengers	2	Neutral throttle lever	16
Overloading.....	2	Tiller handle.....	16
Avoid collisions	3	Gear shift lever.....	16
Weather	3	Throttle grip	17
Passenger training	3	Throttle indicator	17
Boating safety publications	3	Throttle friction adjuster.....	17
Laws and regulations	3	Engine shut-off cord (lanyard) and clip.....	18
General information	4	Engine stop button	18
Identification numbers record	4	Main switch	19
Outboard motor serial number	4	Steering friction adjuster	19
Key number.....	4	Power trim and tilt switch on remote control or tiller handle	19
EC Declaration of Conformity (DoC).....	4	Power trim and tilt switch on bottom cowling	20
CE Marking	4	Trim tab with anode.....	20
Read manuals and labels.....	6	Tilt support lever for power trim and tilt model.....	21
Warning labels	6	Cowling lock lever(s) (turn type).....	21
Specifications and requirements	9	Flushing device	21
Specifications	9	Instruments and indicators	22
Installation requirements	10	Digital tachometer	22
Boat horsepower rating	10	Tachometer	22
Mounting motor	10	Trim meter.....	22
Remote control requirements	10	Hour meter	22
Battery requirements	11	Oil level indicator (digital type)	23
Battery specifications	11	Overheat-alert indicator.....	23
Mounting battery	11	Digital speedometer	23
Multiple batteries	11	Speedometer.....	23
Propeller selection.....	11		
Start-in-gear protection	12		
Engine oil requirements	12		

Table of contents

Fuel gauge	24	Warming up engine	42
Trip meter / Clock / Voltmeter	24	Electric start and prime start	
Fuel level-alert indicator	25	models	42
Low battery voltage-alert		Checks after engine warm up	42
indicator	25	Shifting	42
Analog tachometer	25	Stop switches	42
Oil level indicators (three		Shifting	42
indicators)	25	Stopping boat	44
Analog trim meter	26	Stopping engine	44
Engine control system	27	Procedure	44
Alert system	27	Trimming outboard motor	45
Overheat alert	27	Adjusting trim angle (Power trim	
Oil level alert and oil filter clogging		and tilt)	45
alert	27	Adjusting boat trim	46
Installation	29	Tilting up and down	47
Installation	29	Procedure for tilting up (power trim	
Mounting the outboard motor	29	and tilt models)	47
Operation	31	Procedure for tilting down (power	
First-time operation	31	trim and tilt models)	49
Breaking in engine	31	Shallow water	50
Getting to know your boat	31	Power trim and tilt models	50
Checks before starting engine	31	Cruising in other conditions	51
Fuel level	32	Maintenance	52
Remove cowling	32	Transporting and storing outboard	
Fuel system	32	motor	52
Controls	32	Storing outboard motor	52
Engine shut-off cord (lanyard)	33	Procedure	53
Oil	33	Lubrication (oil injection models)	54
Engine	33	Flushing power unit	54
Operation after long period of		Cleaning the outboard motor	55
storage	33	Checking painted surface of	
Flushing device	34	outboard motor	55
Install cowling	34	Periodic maintenance	55
Checking power trim and tilt		Replacement parts	55
system	35	Severe operating conditions	56
Battery	36	Maintenance chart 1	57
Filling fuel and engine oil	36	Maintenance chart 2	59
Filling fuel for portable tank	36	Greasing	60
Filling oil for electric start models	37	Cleaning and adjusting spark	
Oil level indicator operation	38	plug	60
Operating engine	38	Checking fuel filter	61
Sending fuel (portable tank)	38	Inspecting idle speed	61
Starting engine	39	Checking water in engine oil tank	62
Checks after starting engine	42	Inspecting wiring and connectors	62
Cooling water	42	Checking propeller	62

Table of contents

Removing propeller	63
Installing propeller	63
Changing gear oil	64
Cleaning fuel tank	65
Inspecting and replacing anode(s)	65
Checking battery (for electric start models)	66
Connecting the battery	66
Disconnecting the battery	67
Trouble Recovery	68
Troubleshooting	68
Temporary action in emergency	71
Impact damage	71
Replacing fuse	71
Power trim and tilt will not operate	72
Starter will not operate	72
Emergency starting engine	73
Engine fails to operate	74
Ignition system malfunction	74
Cold engine fails to start	74
Treatment of submerged motor	75

EMU33622

Outboard motor safety

Observe these precautions at all times.

EMU36501

Propeller

People can be injured or killed if they come in contact with the propeller. The propeller can keep moving even when the motor is in neutral, and sharp edges of the propeller can cut even when stationary.

- Stop the engine when a person is in the water near you.
- Keep people out of reach of the propeller, even when the engine is off.

EMU33630

Rotating parts

Hands, feet, hair, jewelry, clothing, PFD straps, etc. can become entangled with internal rotating parts of the engine, resulting in serious injury or death.

Keep the top cowling in place whenever possible. Do not remove or replace the cowling with the engine running.

Only operate the engine with the cowling removed according to the specific instructions in the manual. Keep hands, feet, hair, jewelry, clothing, PFD straps, etc. away from any exposed moving parts.

EMU33640

Hot parts

During and after operation, engine parts are hot enough to cause burns. Avoid touching any parts under the top cowling until the engine has cooled.

EMU33650

Electric shock

Do not touch any electrical parts while starting or operating the engine. They can cause shock or electrocution.

EMU33660

Power trim and tilt

Body parts can be crushed between the mo-

tor and the clamp bracket when the motor is trimmed or tilted. Keep body parts out of this area at all times. Be sure no one is in this area before operating the power trim and tilt mechanism.

The power trim and tilt switches operate even when the main switch is off. Keep people away from the switches whenever working around the motor.

Never get under the lower unit while it is tilted, even when the tilt support lever is locked. Severe injury could occur if the outboard motor accidentally falls.

EMU33671

Engine shut-off cord (lanyard)

Attach the engine shut-off cord so that the engine stops if the operator falls overboard or leaves the helm. This prevents the boat from running away under power and leaving people stranded, or running over people or objects.

Always attach the engine shut-off cord to a secure place on your clothing or your arm or leg while operating. Do not remove it to leave the helm while the boat is moving. Do not attach the cord to clothing that could tear loose, or route the cord where it could become entangled, preventing it from functioning.

Do not route the cord where it is likely to be accidentally pulled out. If the cord is pulled during operation, the engine will shut off and you will lose most steering control. The boat could slow rapidly, throwing people and objects forward.

EMU33810

Gasoline

Gasoline and its vapors are highly flammable and explosive. Always, refuel according to the procedure on page 38 to reduce the risk of fire and explosion.

Safety information

EMU33820

Gasoline exposure and spills

Take care not to spill gasoline. If gasoline spills, wipe it up immediately with dry rags. Dispose of rags properly.

If any gasoline spills onto your skin, immediately wash with soap and water. Change clothing if gasoline spills on it.

If you swallow gasoline, inhale a lot of gasoline vapor, or get gasoline in your eyes, get immediate medical attention. Never siphon fuel by mouth.

EMU33900

Carbon monoxide

This product emits exhaust gases which contain carbon monoxide, a colorless, odorless gas which may cause brain damage or death when inhaled. Symptoms include nausea, dizziness, and drowsiness. Keep cockpit and cabin areas well ventilated. Avoid blocking exhaust outlets.

EMU33780

Modifications

Do not attempt to modify this outboard motor. Modifications to your outboard motor may reduce safety and reliability, and render the outboard unsafe or illegal to use.

EMU33740

Boating safety

This section includes a few of the many important safety precautions that you should follow when boating.

EMU33710

Alcohol and drugs

Never operate after drinking alcohol or taking drugs. Intoxication is one of the most common factors contributing to boating fatalities.

EMU33720

Personal flotation devices

Have an approved personal flotation device (PFD) on board for every occupant. Yamaha recommends that you must wear a PFD

whenever boating. At a minimum, children and non-swimmers should always wear PFDs, and everyone should wear PFDs when there are potentially hazardous boating conditions.

EMU33731

People in the water

Always watch carefully for people in the water, such as swimmers, skiers, or divers, whenever the engine is running. When someone is in the water near the boat, shift into neutral and stop the engine.

Stay away from swimming areas. Swimmers can be hard to see.

The propeller can keep moving even when the motor is in neutral. Stop the engine when a person is in the water near you.

EMU33751

Passengers

Consult your boat manufacturer's instructions for details about appropriate passenger locations in your boat and be sure all passengers are positioned properly before accelerating and when operating above an idle speed. Standing or sitting in non-designated locations may result in being thrown either overboard or within the boat due to waves, wakes, or sudden changes in speed or direction. Even when people are positioned properly, alert your passengers if you must make any unusual maneuver. Always avoid jumping waves or wakes.

EMU33760

Overloading

Do not overload the boat. Consult the boat capacity plate or boat manufacturer for maximum weight and number of passengers. Be sure that weight is properly distributed according to the boat manufacturers instructions. Overloading or incorrect weight distribution can compromise the boats handling and lead to an accident, capsizing or

swamping.

EMU33772

Avoid collisions

Scan constantly for people, objects, and other boats. Be alert for conditions that limit your visibility or block your vision of others.

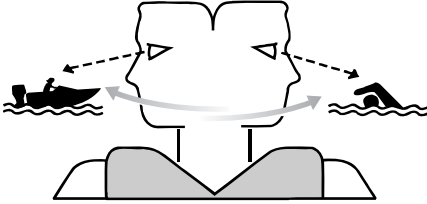

ZMU06025

Operate defensively at safe speeds and keep a safe distance away from people, objects, and other boats.

- Do not follow directly behind other boats or waterskiers.
- Avoid sharp turns or other maneuvers that make it hard for others to avoid you or understand where you are going.
- Avoid areas with submerged objects or shallow water.
- Ride within your limits and avoid aggressive maneuvers to reduce the risk of loss of control, ejection, and collision.
- Take early action to avoid collisions. Remember, boats do not have brakes, and stopping the engine or reducing throttle can reduce the ability to steer. If you are not sure that you can stop in time before hitting an obstacle, apply throttle and turn in another direction.

EMU33790

Weather

Stay informed about the weather. Check weather forecasts before boating. Avoid boating in hazardous weather.

EMU33880

Passenger training

Make sure at least one other passenger is trained to operate the boat in the event of an emergency.

EMU33890

Boating safety publications

Be informed about boating safety. Additional publications and information can be obtained from many boating organizations.

EMU33600

Laws and regulations

Know the marine laws and regulations where you will be boating- and obey them. Several sets of rules prevail according to geographic location, but all are basically the same as the International Rules of the Road.

General information

EMU25171

Identification numbers record

EMU25183

Outboard motor serial number

The outboard motor serial number is stamped on the label attached to the port side of the clamp bracket.

Record your outboard motor serial number in the spaces provided to assist you in ordering spare parts from your Yamaha dealer or for reference in case your outboard motor is stolen.

--	--	--	--

ZMU01693

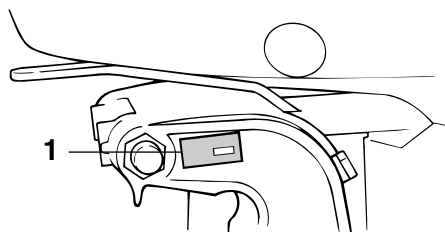

ZMU02931

1. Outboard motor serial number location

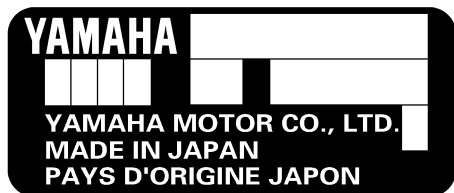

ZMU01692

EMU25190

Key number

If a main key switch is equipped with the motor, the key identification number is stamped on your key as shown in the illustration. Record this number in the space provided for reference in case you need a new key.

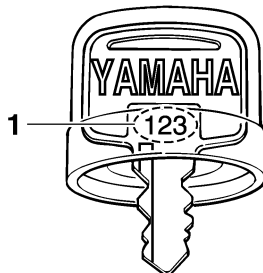

ZMU01694

1. Key number

EMU37290

EC Declaration of Conformity (DoC)

This outboard motor conforms to certain portions of the European Parliament directive relating to machinery.

Each conformed outboard motor accompanied with EC DoC. EC DoC contains the following information;

- Name of Engine Manufacture
- Model name
- Product code of model (Approved model code)
- Code of conformed directives

EMU25203

CE Marking

Outboard motors affixed with this "CE" marking conform with the directives of; 98/37/EC, 94/25/EC - 2003/44/EC and 2004/108/EC.

General information

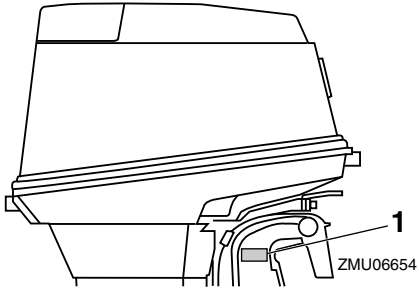

1. CE marking location



ZMU06040

General information

EMU33522

Read manuals and labels

Before operating or working on this outboard motor:

- Read this manual.
- Read any manuals supplied with the boat.
- Read all labels on the outboard motor and the boat.

If you need any additional information, contact your Yamaha dealer.

EMU33832

Warning labels

If these labels are damaged or missing, contact your Yamaha dealer for replacements.

75C, 90A

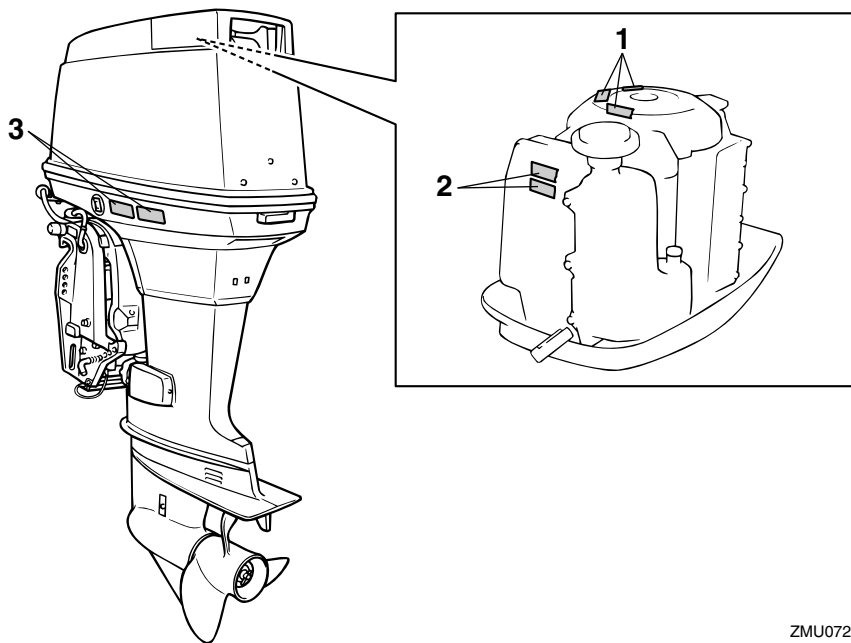

ZMU07220

1

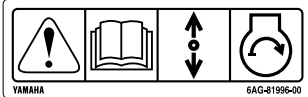

2



3



ZMU05706

EMU33912

Contents of labels

The above warning labels mean as follows.

1

EWM01691

⚠ WARNING
Emergency starting does not have start-in-gear protection. Ensure shift control is in neutral before starting engine.

2

EWM01681

⚠ WARNING
• Keep hands, hair, and clothing away from rotating parts while the engine is running.
• Do not touch or remove electrical parts when starting or during operation.

3

EWM01671

⚠ WARNING
• Read Owner's Manuals and labels.
• Wear an approved personal flotation device (PFD).
• Attach engine shut-off cord (lanyard) to your PFD, arm, or leg so the engine stops if you accidentally leave the helm, which could prevent a runaway boat.

General information

EMU33843

Symbols

The following symbols mean as follows.

Notice/Warning



ZMU05696

Read Owner's Manual



ZMU05664

Hazard caused by continuous rotation

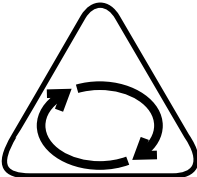

ZMU05665

Electrical hazard

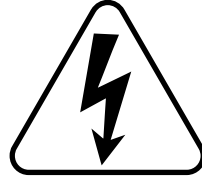

ZMU05666

Remote control lever/gear shift lever operating direction, dual direction



ZMU05667

Engine start/ Engine cranking

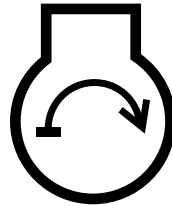

ZMU05668

Specifications and requirements

EMU31480

Specifications

TIP:

“(AL)” stated in the specification data below represents the numerical value for the aluminum propeller installed.

Likewise, “(SUS)” represents the value for stainless steel propeller installed and “(PL)” for plastic propeller installed.

EMU2821J

Dimension:

Overall length:

726 mm (28.6 in)

Overall width:

374 mm (14.7 in)

Overall height L:

1413 mm (55.6 in)

Overall height X:

1540 mm (60.6 in)

Transom height L:

520 mm (20.5 in)

Transom height X:

647 mm (25.5 in)

Weight (AL) L:

120.5 kg (266 lb)

Weight (AL) X:

123.5 kg (272 lb)

Weight (SUS) L:

122.5 kg (270 lb)

Weight (SUS) X:

125.5 kg (277 lb)

Performance:

Full throttle operating range:

4500–5500 r/min

Maximum output:

75CETO 55.2 kW@5000 r/min

(75 HP@5000 r/min)

90AETO 66.2 kW@5000 r/min

(90 HP@5000 r/min)

Idle speed (in neutral):

800 ±50 r/min

Engine:

Type:

2-stroke L

Displacement:

1140.0 cm³

Bore × stroke:

82.0 × 72.0 mm (3.23 × 2.83 in)

Ignition system:

CDI (micro computer)

Spark plug with resistor (NGK):

BR8HS-10

Spark plug gap:

0.9–1.0 mm (0.035–0.039 in)

Control system:

Remote control

Starting system:

Electric starter

Starting carburetion system:

Prime start

Min. cold cranking amps (CCA/EN):

430.0 A

Min. rated capacity (20HR/IEC):

70.0 Ah

Maximum generator output:

10 A

Drive unit:

Gear positions:

Forward-neutral-reverse

Gear ratio:

2.00 (26/13)

Trim and tilt system:

Power trim and tilt

Propeller mark:

K

Fuel and oil:

Recommended fuel:

Regular unleaded gasoline

Min. research octane:

75CETO 90

90AETO 90

Specifications and requirements

Fuel tank capacity:

24 L (6.34 US gal, 5.28 Imp.gal),

25 L (6.60 US gal, 5.50 Imp.gal)

Recommended engine oil:

YAMALUBE 2-stroke outboard motor oil

Recommended engine oil:

TC-W3

Lubrication:

Oil injection

Engine oil tank capacity:

3.3 L (3.49 US qt, 2.90 Imp.qt)

Recommended gear oil:

Hypoid gear oil SAE#90

Gear oil quantity:

0.610 L (0.645 US qt, 0.537 Imp.qt)

Tightening torque for engine:

Spark plug:

25.0 Nm (2.55 kgf-m, 18.4 ft-lb)

Propeller nut:

35.0 Nm (3.57 kgf-m, 25.8 ft-lb)

Noise and vibration level:

Operator sound pressure level

(ICOMIA 39/94 and 40/94):

75CETO 91.1 dB(A)

90AETO 91.1 dB(A)

Sound power level

(ICOMIA 39/94 and 40/94):

75CETO 98.9 dB(A)

90AETO 98.9 dB(A)

Vibration on tiller handle (ICOMIA 38/94):

75CETO 2.8 m/s²

90AETO 2.8 m/s²

EMU33554

Installation requirements

EMU33564

Boat horsepower rating

EWMM01560



Overpowering a boat can cause severe instability.

Before installing the outboard motor(s), confirm that the total horsepower of your outboard motor(s) does not exceed the boat's maximum horsepower rating. See the boat's capacity plate or contact the manufacturer.

EMU33571

Mounting motor

EWMM01570



- **Improper mounting of the outboard motor could result in hazardous conditions such as poor handling, loss of control, or fire hazards.**
 - **Because the motor is very heavy, special equipment and training is required to mount it safely.**
-

Your dealer or other person experienced in proper rigging should mount the motor using correct equipment and complete rigging instructions. For further information, see page 29.

EMU33581

Remote control requirements

EWMM01580



- **If the engine starts in gear, the boat can move suddenly and unexpectedly, possibly causing a collision or throwing passengers overboard.**
 - **If the engine ever starts in gear, the start-in-gear protection device is not working correctly and you should discontinue using the outboard. Contact your Yamaha dealer.**
-

The remote control unit must be equipped with a start-in-gear protection device(s). This device prevents the engine from starting unless it is in neutral.

Specifications and requirements

EMU25694

Battery requirements

EMU25721

Battery specifications

Minimum cold cranking amps (CCA/EN): 430.0 A
Minimum rated capacity (20HR/IEC): 70.0 Ah

The engine cannot be started if battery voltage is too low.

EMU36290

Mounting battery

Mount the battery holder securely in a dry, well-ventilated, vibration-free location in the boat. **WARNING! Do not put flammable items, or loose heavy or metal objects in the same compartment as the battery. Fire, explosion or sparks could result.**

[EWM01820]

EMU36300

Multiple batteries

To connect multiple batteries, such as for multiple engine configurations or for an accessory battery, consult your Yamaha dealer about battery selection and correct wiring.

EMU34194

Propeller selection

Next to selecting an outboard motor, selecting the right propeller is one of the most important purchasing decisions a boater can make. The type, size, and design of your propeller have a direct impact on acceleration, top speed, fuel economy, and even engine life. Yamaha designs and manufactures propellers for every Yamaha outboard motor and every application.

Your outboard motor came with a Yamaha propeller selected to perform well over a range of applications, but there may be uses where a different propeller would be more appropriate.

Your Yamaha dealer can help you select the right propeller for your boating needs. Select a propeller that will allow the engine to reach the middle or upper half of the operating range at full throttle with the maximum boat-load. Generally, select a larger pitch propeller for a smaller operating load and a smaller pitch propeller for a heavier load. If you carry loads that vary widely, select the propeller that lets the engine run in the proper range for your maximum load but remember that you may need to reduce your throttle setting to stay within the recommended engine speed range when carrying lighter loads. To check the propeller, see page 62.

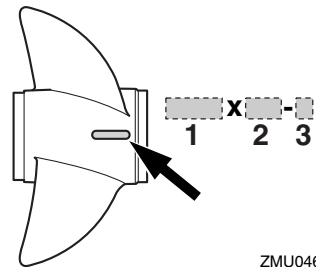

1. Propeller diameter in inches
2. Propeller pitch in inches
3. Type of propeller (propeller mark)

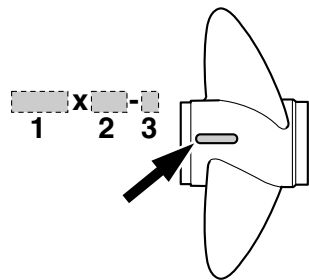

1. Propeller diameter in inches
2. Propeller pitch in inches

Specifications and requirements

3. Type of propeller (propeller mark)

EMU25770

Start-in-gear protection

Yamaha outboard motors or Yamaha-approved remote control units are equipped with start-in-gear protection device(s). This feature permits the engine to be started only when it is in neutral. Always select neutral before starting the engine.

EMU25651

Engine oil requirements

Recommended engine oil:
YAMALUBE 2-stroke outboard motor oil

If the recommended engine oil is not available, another 2-stroke engine oil with an NMMA-certified TC-W3 rating may be used.

EMU36360

Fuel requirements

EMU36802

Gasoline

Use a good quality gasoline that meets the minimum octane rating. If knocking or ping-ing occurs, use a different brand of gasoline or premium unleaded fuel.

Recommended gasoline:
Regular unleaded gasoline with a minimum octane rating of 90 (Research Octane Number).

ECM01981

NOTICE

- **Do not use leaded gasoline. Leaded gasoline can seriously damage the engine.**
- **Avoid getting water and contaminants in the fuel tank. Contaminated fuel can cause poor performance or engine damage. Use only fresh gasoline that**

has been stored in clean containers.

EMU36880

Muddy or acidic water

Yamaha strongly recommends that you have your dealer install the optional chromium-plated water pump kit if you use the outboard motor in muddy or acidic water conditions. However, depending on the model it might not be required.

EMU36330

Anti-fouling paint

A clean hull improves boat performance. The boat bottom should be kept as clean of marine growth as possible. If necessary, the boat bottom can be coated with an anti-fouling paint approved for your area to inhibit marine growth.

Do not use anti-fouling paint which includes copper or graphite. These paints can cause more rapid engine corrosion.

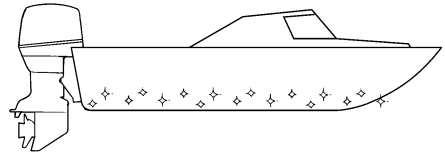

ZMU05176

EMU36341

Motor disposal requirements

Never illegally discard (dump) the motor. Yamaha recommends consulting the dealer about discarding the motor.

EMU36352

Emergency equipment

Keep the following items onboard in case there is trouble with the outboard motor.

- A tool kit with assorted screwdrivers, pliers, wrenches (including metric sizes), and

Specifications and requirements

electrical tape.

- Waterproof flashlight with extra batteries.
- An extra engine shut-off cord (lanyard) with clip.
- Spare parts, such as an extra set of spark plugs.

Consult your Yamaha dealer for details.

Components

EMU2579T

Components diagram

TIP:

* May not be exactly as shown; also may not be included as standard equipment on all models (order from dealer).

75C, 90A

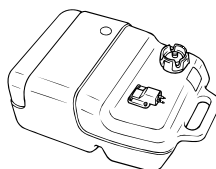
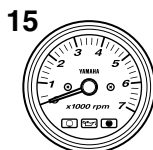
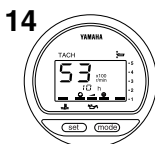
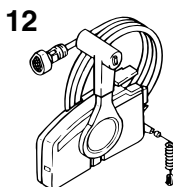
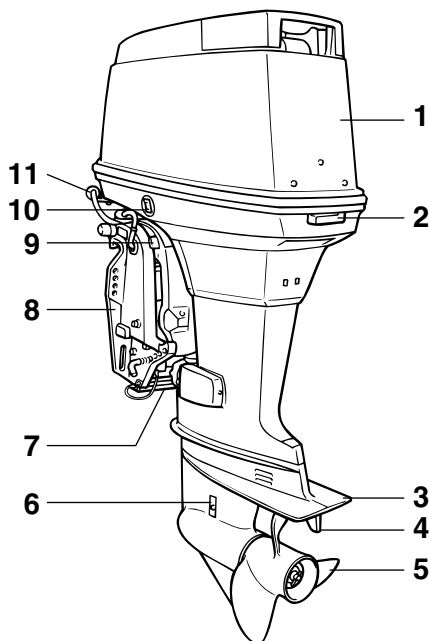

ZMU07226

1. Top cowling
2. Cowling lock lever(s)
3. Anti-cavitation plate
4. Trim tab (anode)
5. Propeller
6. Cooling water inlet
7. Anode
8. Clamp bracket
9. Tilt support lever
10. Power trim and tilt switch
11. Flushing device
12. Remote control box (side mount type)
13. Digital speedometer*
14. Digital tachometer
15. Tachometer*

16. Trim meter*
17. Fuel tank

EMU25802

Fuel tank

If your model was equipped with a portable fuel tank, its function is as follows.

EWM00020



WARNING

The fuel tank supplied with this engine is its dedicated fuel reservoir and must not be used as a fuel storage container. Commercial users should conform to relevant licensing or approval authority regula-

tions.

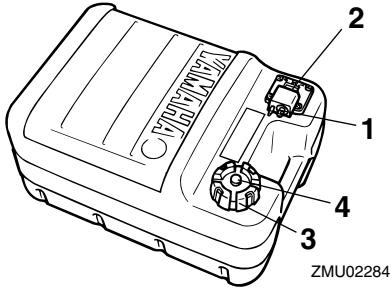

ZMU02284

1. Fuel joint
2. Fuel gauge
3. Fuel tank cap
4. Air vent screw

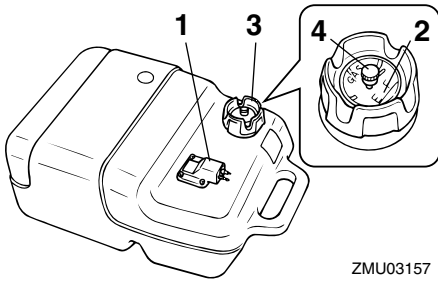

ZMU03157

1. Fuel joint
2. Fuel gauge
3. Fuel tank cap
4. Air vent screw

EMU25830

Fuel joint

This joint is used to connect the fuel line.

EMU25841

Fuel gauge

This gauge is located on either the fuel tank cap or on the fuel joint base. It shows the approximate amount of fuel remaining in the tank.

EMU25850

Fuel tank cap

This cap seals the fuel tank. When removed, the tank can be filled with fuel. To remove the cap, turn it counterclockwise.

EMU25860

Air vent screw

This screw is on the fuel tank cap. To loosen the screw, turn it counterclockwise.

EMU26181

Remote control box

The remote control lever actuates both the shifter and the throttle. The electrical switches are mounted on the remote control box.

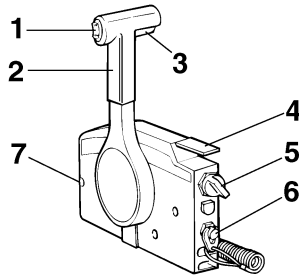

ZMU01723

1. Power trim and tilt switch
2. Remote control lever
3. Neutral interlock trigger
4. Neutral throttle lever
5. Main switch
6. Engine shut-off switch
7. Throttle friction adjuster

EMU26190

Remote control lever

Moving the lever forward from the neutral position engages forward gear. Pulling the lever back from neutral engages reverse. The engine will continue to run at idle until the lever is moved about 35° (a detent can be felt). Moving the lever farther opens the throttle, and the engine will begin to accelerate.

Components

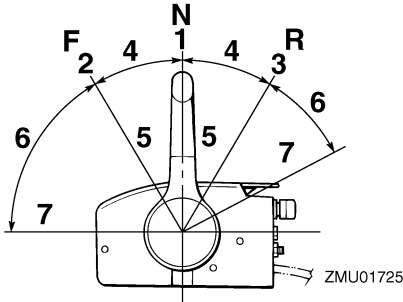

1. Neutral "N"
2. Forward "F"
3. Reverse "R"
4. Shift
5. Fully closed
6. Throttle
7. Fully open

EMU26201

Neutral interlock trigger

To shift out of neutral, first pull the neutral interlock trigger up.

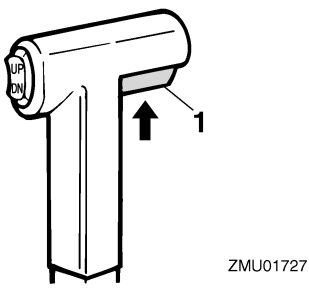

1. Neutral interlock trigger

EMU26212

Neutral throttle lever

To open the throttle without shifting into either forward or reverse, put the remote control lever in the neutral position and lift the neutral throttle lever.

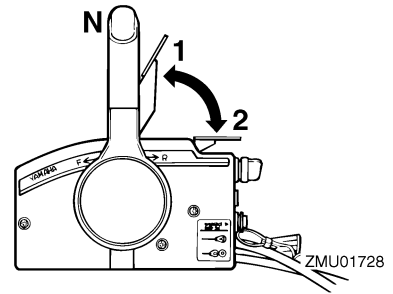

1. Fully open
2. Fully closed

TIP:

The neutral throttle lever will operate only when the remote control lever is in neutral. The remote control lever will operate only when the neutral throttle lever is in the closed position.

EMU25912

Tiller handle

To change direction, move the tiller handle to the left or right as necessary.

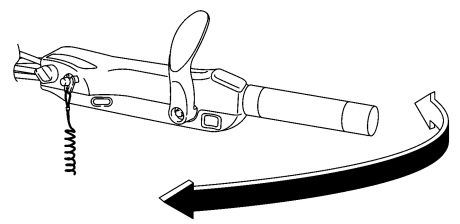

EMU25923

Gear shift lever

Move the gear shift lever forward to engage the forward gear or rearward to engage the reverse gear.

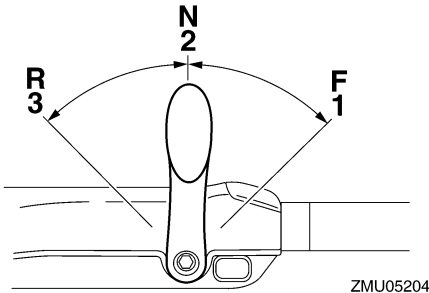

ZMU05204

1. Forward "F"
2. Neutral "N"
3. Reverse "R"

EMU25941

Throttle grip

The throttle grip is on the tiller handle. Turn the grip counterclockwise to increase speed and clockwise to decrease speed.

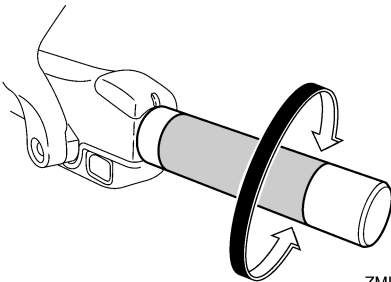

ZMU05205

EMU25961

Throttle indicator

The fuel consumption curve on the throttle indicator shows the relative amount of fuel consumed for each throttle position. Choose the setting that offers the best performance and fuel economy for the desired operation.

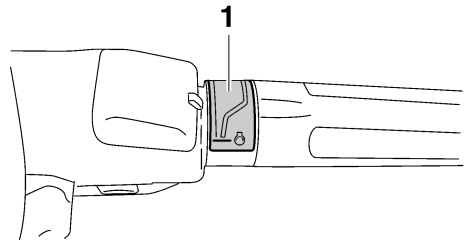

ZMU05206

1. Throttle indicator

EMU25976

Throttle friction adjuster

A friction device provides adjustable resistance to movement of the throttle grip or the remote control lever, and can be set according to operator preference.

To increase resistance, turn the adjuster clockwise. To decrease resistance, turn the adjuster counterclockwise. **WARNING! Do not overtighten the friction adjuster. If there is too much resistance, it could be difficult to move the remote control lever or throttle grip, which could result in an accident.** [EWM00032]

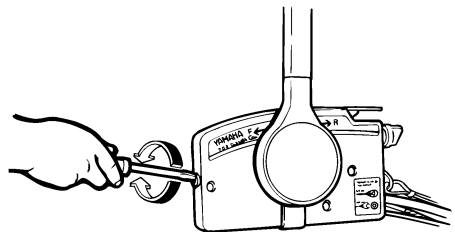

ZMU01714

Components

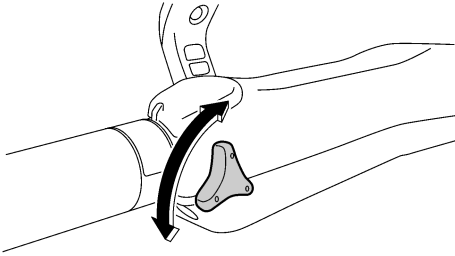

ZMU05207

When constant speed is desired, tighten the adjuster to maintain the desired throttle setting.

EMU25994

Engine shut-off cord (lanyard) and clip

The clip must be attached to the engine shut-off switch for the engine to run. The cord should be attached to a secure place on the operator's clothing, or arm or leg. Should the operator fall overboard or leave the helm, the cord will pull out the clip, stopping ignition to the engine. This will prevent the boat from running away under power. **WARNING! Attach the engine shut-off cord to a secure place on your clothing, or your arm or leg while operating. Do not attach the cord to clothing that could tear loose. Do not route the cord where it could become entangled, preventing it from functioning. Avoid accidentally pulling the cord during normal operation. Loss of engine power means the loss of most steering control. Also, without engine power, the boat could slow rapidly. This could cause people and objects in the boat to be thrown forward.** [EWM00122]

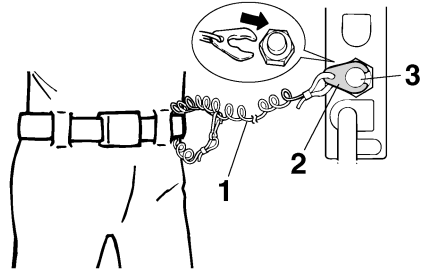

ZMU01716

1. Cord
2. Clip
3. Engine shut-off switch

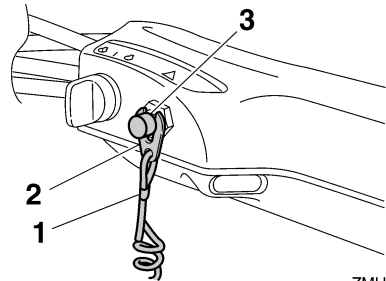

ZMU05208

1. Cord
2. Clip
3. Engine shut-off switch

EMU26002

Engine stop button

The engine stop button stops the engine when the button is pushed.

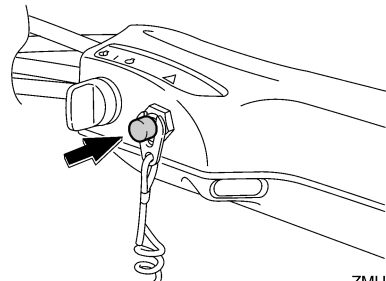

ZMU05209

EMU26091

Main switch

The main switch controls the ignition system; its operation is described below.

- “OFF” (off)

With the main switch in the “OFF” (off) position, the electrical circuits are off, and the key can be removed.

- “ON” (on)

With the main switch in the “ON” (on) position, the electrical circuits are on, and the key cannot be removed.

- “START” (start)

With the main switch in the “START” (start) position, the starter motor turns to start the engine. When the key is released, it returns automatically to the “ON” (on) position.

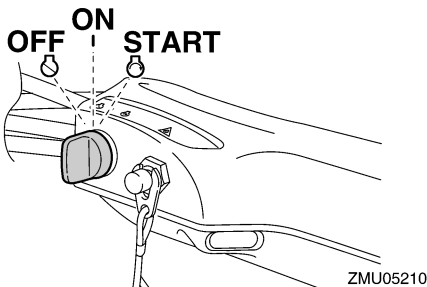
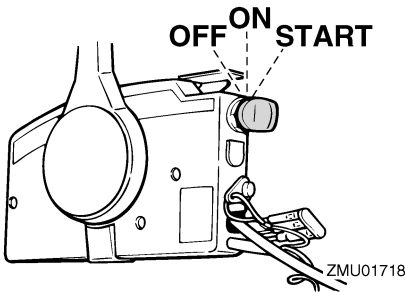

EMU26130

Steering friction adjuster

A friction device provides adjustable resistance to the steering mechanism, and can be

set according to operator preference. An adjusting screw or bolt is located on the clamp bracket, on the right (starboard) side of the through tube end.

To increase resistance, turn the adjuster clockwise.

To decrease resistance, turn the adjuster counterclockwise.

EWMM0040

WARNING

Do not overtighten the friction adjuster. If there is too much resistance, it could be difficult to steer, which could result in an accident.

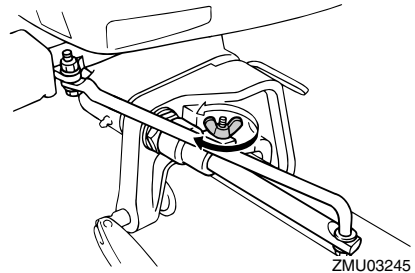

EMU26143

Power trim and tilt switch on remote control or tiller handle

The power trim and tilt system adjusts the outboard motor angle in relation to the transom. Pressing the switch “UP” (up) trims the outboard motor up, and then tilts it up. Pressing the switch “DN” (down) tilts the outboard motor down and trims it down. When the switch is released, the outboard motor will stop in its current position.

For instructions on using the power trim and tilt switch, see pages 45 and 47.

Components

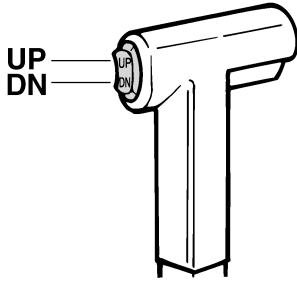

ZMU01720

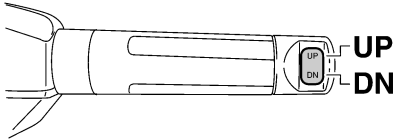

ZMU05211

EMU26154

Power trim and tilt switch on bottom cowling

The power trim and tilt switch is located on the side of the bottom cowling. Pushing the switch “UP” (up) trims the outboard motor up, and then tilts it up. Pushing the switch “DN” (down) tilts the outboard motor down and trims it down. When the switch is released, the outboard motor will stop in its current position.

For instructions on using the power trim and tilt switch, see page 47.

EWMM01031

WARNING

Use the power trim and tilt switch located on the bottom cowling only when the boat is at a complete stop with the engine off. Attempting to use this switch while the boat is moving could increase the risk of falling overboard and could distract the

operator, increasing the risk of collision with another boat or an obstacle.

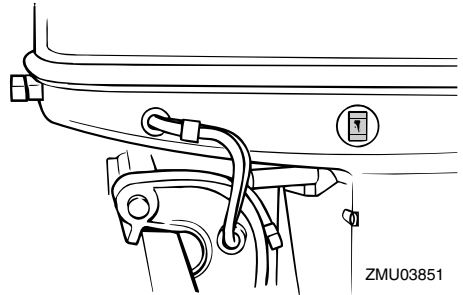

ZMU03851

EMU26244

Trim tab with anode

EWMM00840

WARNING

An improperly adjusted trim tab could cause difficult steering. Always test run after the trim tab has been installed or replaced to be sure steering is correct. Be sure you have tightened the bolt after adjusting the trim tab.

The trim tab should be adjusted so that the steering control can be turned to either the right or left by applying the same amount of force.

If the boat tends to veer to the left (port side), turn the trim tab rear end to the port side “A” in the figure. If the boat tends to veer to the right (starboard side), turn the trim tab end to the starboard side “B” in the figure.

ECM00840

NOTICE

The trim tab also serves as an anode to protect the engine from electrochemical corrosion. Never paint the trim tab as it will become ineffective as an anode.

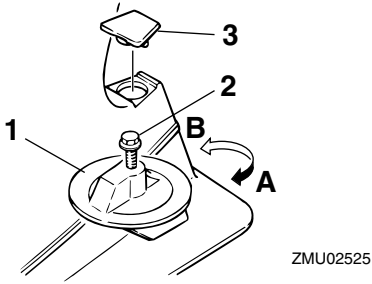

1. Trim tab
2. Bolt
3. Cap

Bolt tightening torque:
37.0 Nm (3.7 kgf-m, 27.3 ft-lb)

EMU26341

Tilt support lever for power trim and tilt model

To keep the outboard motor in the tilted up position, lock the tilt support lever to the clamp bracket.

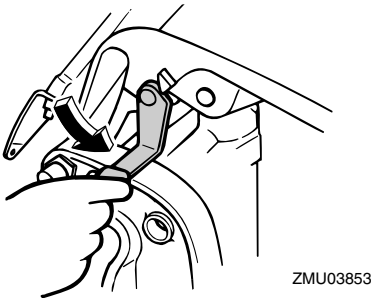

ECM00660

NOTICE

Do not use the tilt support lever or knob when trailering the boat. The outboard motor could shake loose from the tilt support and fall. If the motor cannot be trailered in the normal running position, use an additional support device to secure it

in the tilt position.

EMU26373

Cowling lock lever(s) (turn type)

To remove the engine top cowling, turn the cowling lock lever(s) and lift off the cowling. When installing the cowling, check to be sure it fits properly in the rubber seal. Then lock the cowling again by returning the cowling lock lever(s) to the lock position.

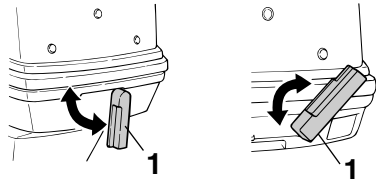

1. Cowling lock lever(s)

EMU26462

Flushing device

This device is used to clean the cooling water passages of the motor using a garden hose and tap water.

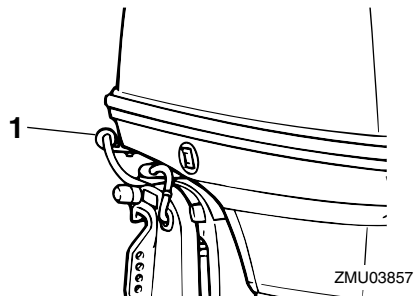

1. Flushing device

TIP:

For details on usage, see page 54.

Instruments and indicators

EMU31414

Digital tachometer

The tachometer shows the engine speed and has the following functions.

All segments of the display will light momentarily after the main switch is turned on and will return to normal thereafter.

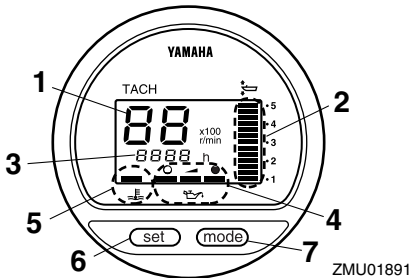

ZMU01891

1. Tachometer
2. Trim meter
3. Hour meter
4. Oil level indicator
5. Overheat-alert indicator
6. Set button
7. Mode button

TIP:

The water separator-alert indicator and engine trouble-alert indicator on the digital tachometer do not operate for this engine.

EMU36050

Tachometer

The tachometer displays engine speed in hundreds of revolutions per minute (r/min). For example, if the tachometer display reads "22" then the engine speed is 2200 r/min.

EMU26621

Trim meter

This meter shows the trim angle of your outboard motor.

- Memorize the trim angles that work best for your boat under different conditions. Adjust the trim angle to the desired using

the power trim and tilt switch.

- If the trim angle of your motor exceeds the trim operating range, the top segment on the trim meter display will blink.

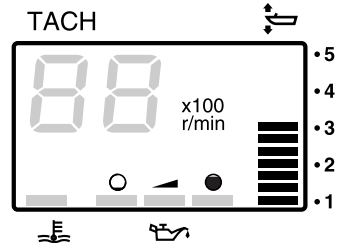

ZMU01869

EMU26651

Hour meter

This meter shows the number of hours the engine has been run. It can be set to show the total number of hours or the number of hours for the current trip. The display can also be turned on and off.

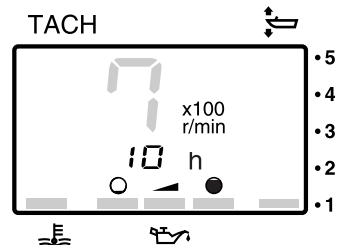

ZMU01870

To change the display format, press the "mode" (mode) button. The display can show total hours or trip hours, or turn off.

To reset the trip hours, simultaneously press the "set" (set) and "mode" (mode) buttons for more than 1 second while the trip hours are displayed. This resets the trip counter to 0 (zero).

The total number of hours the engine has been run cannot be reset.

Instruments and indicators

EMU26551

Oil level indicator (digital type)

This indicator shows the engine oil level. If the oil level falls below the lower limit, the alert indicator will start to blink. For further information, see page 27.

ECM00030

NOTICE

Do not operate the engine without oil. Serious engine damage will occur.

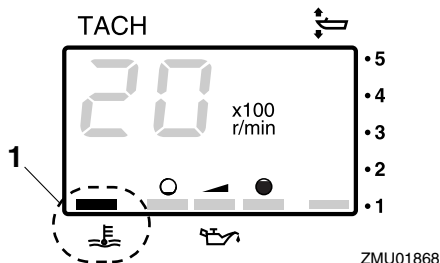

1. Overheat-alert indicator

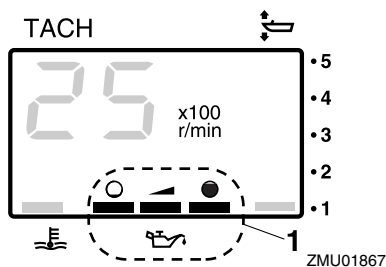

1. Oil level indicator

EMU26583

Overheat-alert indicator

If the engine temperature rises too high, the alert indicator will start to blink. For further information on reading the indicator, see page 27.

ECM00052

NOTICE

Do not continue to run the engine if the overheat-alert indicator is on. Serious engine damage will occur.

EMU26602

Digital speedometer

This gauge shows the boat speed and other information.

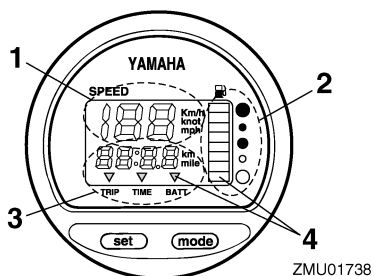

1. Speedometer
2. Fuel gauge
3. Trip meter/clock/voltmeter
4. Alert indicator(s)

All segments of the display will light momentarily after the main switch is turned on and will return to normal thereafter.

EMU36061

Speedometer

The speedometer displays km/h, mph, or knots, according to operator preference. Select the desired units of measurement by setting the selector switch on the back of the gauge. See the illustration for settings.

Instruments and indicators

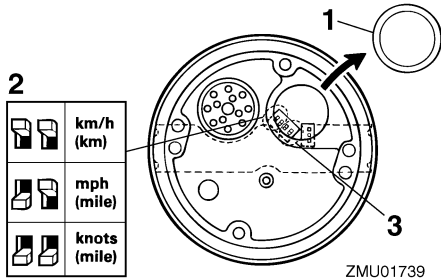

ZMU01739

1. Cap
2. Selector switch (for speed unit)
3. Selector switch (for fuel sensor)

EMU26713

Fuel gauge

Eight segments indicate the fuel level. When all segments are showing, the fuel tank is full.

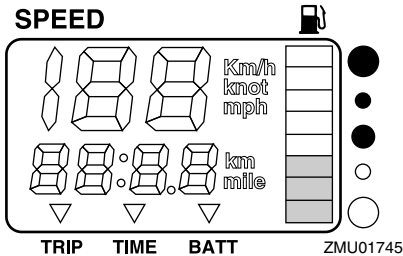

ZMU01745

The fuel level reading can be inaccurate due to the position of the sensor in the fuel tank and the attitude of the boat in the water. Operation with bow-up trim or continuous turning can give false readings.

Do not adjust the selector switch for fuel sensor. Incorrectly setting the selector switch on the gauge will give false readings. Consult your Yamaha dealer on how to correctly set the selector switch. **NOTICE: Running out of fuel can damage the engine.** [ECM01770]

EMU36071

Trip meter / Clock / Voltmeter

The display shows either the trip meter, the clock, or the voltmeter.

To change the display, press the “mode” (mode) button repeatedly until the indicator on the face of the gauge points to “TRIP” (trip meter), “TIME” (clock), or “BATT” (voltmeter).

EMU26691

Trip meter

This gauge displays the distance the boat has traveled since the gauge was last reset. The trip distance is shown in kilometers or miles depending upon the unit of measurement selected for the speedometer.

To reset the trip meter to zero, press the “set” (set) and “mode” (mode) buttons at the same time.

The trip distance is kept in memory by battery power. The stored data will be lost if the battery is disconnected.

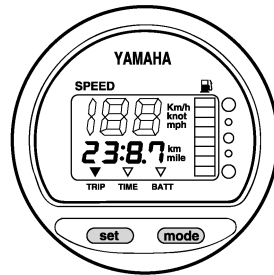

ZMU01743

EMU26701

Clock

To set the clock:

1. Be sure the gauge is in the “TIME” (time) mode.
2. Press the “set” (set) button; the hour display will begin blinking.
3. Press the “mode” (mode) button until the desired hour is displayed.
4. Press the “set” (set) button again, the minute display will begin blinking.

Instruments and indicators

- Press the “mode” (mode) button until the desired minute is displayed.
- Press the “set” (set) button again to start the clock.

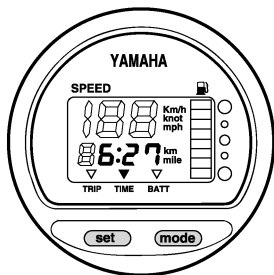

ZMU01744

The clock operates on battery power. Disconnecting the battery will stop the clock. Reset the clock after connecting the battery.

EMU36080

Voltmeter

The voltmeter displays the charge of the battery in volts(V).

EMU26721

Fuel level-alert indicator

If the fuel level decreases to one segment, the fuel level alert segment will blink.

Do not continue to operate the engine with full throttle if an alert device has activated. Get back to the port within trolling engine speed. **NOTICE: Running out of fuel can damage the engine.** [ECM01770]

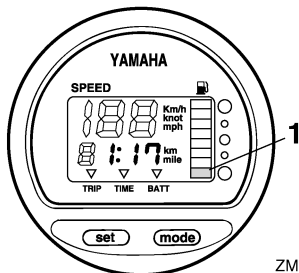

ZMU01746

- Fuel level-alert segment

EMU26732

Low battery voltage-alert indicator

If battery voltage drops, the display will automatically turn on and blink.

Get back to the port soon if an alert device has activated. For charging the battery, consult your Yamaha dealer.

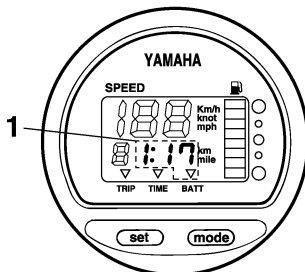

ZMU01747

- Low battery indicator

EMU26471

Analog tachometer

This gauge shows the engine speed and has the following functions.

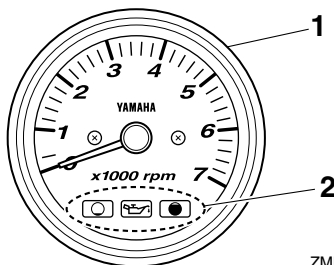

ZMU04577

- Tachometer
- Oil level indicator

EMU26541

Oil level indicators (three indicators)

The indicators on the gauge show the status of the oil level. For details on how to read the indicators, see page 38.

Instruments and indicators

ECM00030

NOTICE

Do not operate the engine without oil. Serious engine damage will occur.

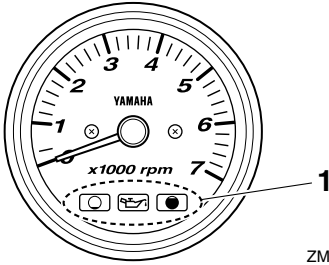

ZMU04580

1. Oil level indicators

EMU26611

Analog trim meter

This gauge shows the trim angle of your out-board motor.

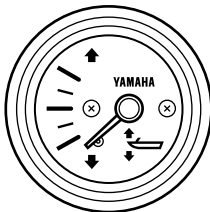

ZMU04581

Memorize the trim angles that work best for your boat under different conditions. Adjust the trim angle to the desired setting with the power trim and tilt switch.

EMU26803

Alert system

ECM00091

NOTICE

Do not continue to operate the engine if a alert device has activated. Consult your Yamaha dealer if the problem cannot be located and corrected.

EMU2681C

Overheat alert

This engine has an overheat-alert device. If the engine temperature rises too high, the alert device will activate.

- The engine speed will automatically decrease to about 2000 r/min.
- The overheat-alert indicator will light or blink.

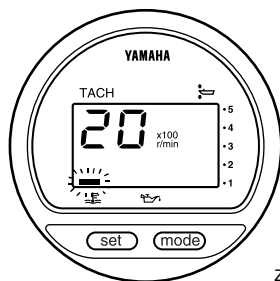

ZMU01757

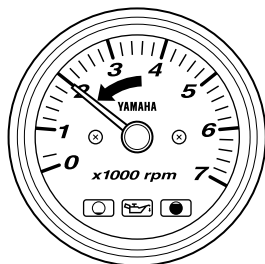

ZMU04766

- The buzzer will sound (if equipped on the tiller handle, remote control box, or main switch panel).

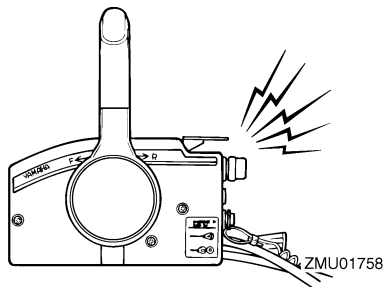

If the alert system has activated, stop the engine and check the cooling water inlets:

- Check trim angle to be sure that the cooling water inlet is submerged.
- Check the cooling water inlet for clogging.

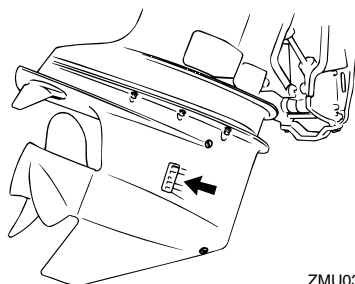

ZMU03858

EMU26848

Oil level alert and oil filter clogging alert

Oil injection models

This engine has an oil level alert system. If the oil level falls below the lower limit, the alert system will activate.

Activation of alert device

- Engine speed will automatically decrease to about 2000 r/min.
- The oil level-alert indicator will light or blink.

Engine control system

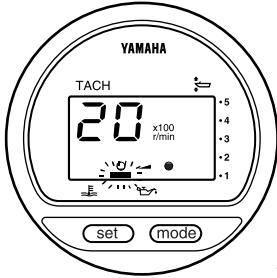

ZMU03942

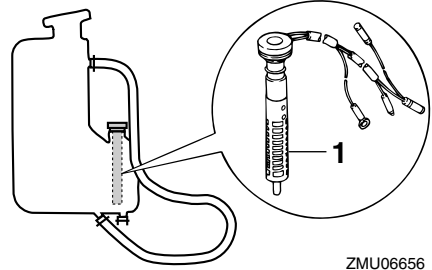

ZMU06656

1. Oil filter

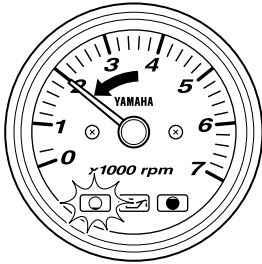

ZMU04586

- The buzzer will sound (if equipped on the tiller handle, remote control box, or main switch panel).

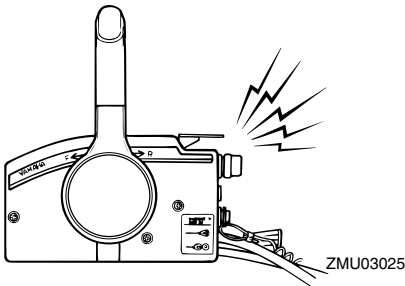

ZMU03025

If the alert system has been activated, stop the engine and check for the cause.

TIP:

The alert for oil filter clogging is similar to the alerts for low oil level and overheating. To make troubleshooting easier, check for engine overheating first, then oil level, and finally oil filter clogging.

EMU26902

Installation

The information presented in this section is intended as reference only. It is not possible to provide complete instructions for every possible boat and motor combination. Proper mounting depends in part on experience and the specific boat and motor combination.

EWMO1590

WARNING

- **Overpowering a boat could cause severe instability. Do not install an outboard motor with more horsepower than the maximum rating on the capacity plate of the boat. If the boat does not have a capacity plate, consult the boat manufacturer.**
- **Improper mounting of the outboard motor could result in hazardous conditions such as poor handling, loss of control, or fire hazards. For permanently mounted models, your dealer or other person experienced in proper rigging should mount the motor.**

EMU33470

Mounting the outboard motor

The outboard motor should be mounted so that the boat is well balanced. Otherwise, the boat could be hard to steer. For single-engine boats, mount the outboard motor on the centerline (keel line) of the boat.

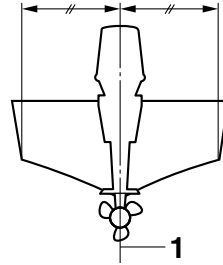

ZMU01760

1. Center line (keel line)

EMU26933

Mounting height (boat bottom)

The mounting height of your outboard motor affects its efficiency and reliability. If it is mounted too high, propeller ventilation may occur, which will reduce propulsion due to excessive propeller slip, and the water intakes for the cooling system may not get adequate water supply, which can cause engine overheating. If the engine is mounted too low, water resistance (drag) will increase, thereby reducing engine efficiency and performance.

Most commonly, outboard motor should be mounted so that the anti-cavitation plate is in alignment with the bottom of the boat. The optimum mounting height of the outboard motor is affected by the boat/motor combination and the desired use. Test runs at different heights can help determine the optimum mounting height. Consult your Yamaha dealer or boat manufacturer for further information on determining the proper mounting height.

Installation

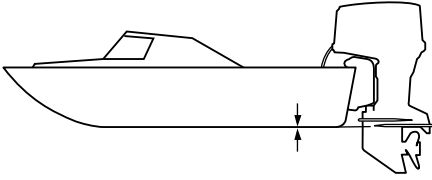

ZMU01762

ECM01634

NOTICE

- Make sure that the idle hole is high enough to prevent water from entering the engine even if the boat is stationary with the maximum load.
 - Incorrect engine height or obstructions to the smooth flow of water (such as the design or condition of the boat, or accessories, such as transom ladders or depth finder transducers) can create airborne water spray while the boat is cruising. If the outboard motor is operated continuously in the presence of airborne water spray, enough water could enter the engine through the air intake opening in the top cowling to cause severe engine damage. Remove the cause of the airborne water spray.
-

EMU36381

First-time operation

EMU27020

Breaking in engine

Your new engine requires a period of break-in to allow mating surfaces of moving parts to wear in evenly. Correct break-in will help ensure proper performance and longer engine life.



ECM00140

NOTICE



- Failure to follow the break-in procedure could result in reduced engine life or even severe engine damage.
- Premix fuel must be used during break-in in addition to oil in the oil injection system.

EMU27060

Gasoline and engine oil mixing chart (50:1)

	50:1			
	1 L (0.26 US gal, 0.22 Imp gal)	12 L (3.2 US gal, 2.6 Imp gal)	14 L (3.7 US gal, 3.1 Imp gal)	24 L (6.3 US gal, 5.3 Imp gal)
	0.02L (0.02 US qt, 0.02 Imp qt)	0.24 L (0.25 US qt, 0.21 Imp qt)	0.28 L (0.3US qt, 0.25 Imp qt)	0.48 L (0.51 US qt, 0.42Imp qt)

ZMU02442

1. : Gasoline
2. : Engine oil

ECM00150

NOTICE

Be sure to mix gasoline and oil completely, otherwise the engine may be damaged.

EMU30311

Procedure for oil injection models

Run the engine under load (in gear with a propeller installed) for 10 hours as follows.

1. First 10 minutes:
Run the engine at the lowest possible

speed. A fast idle in neutral is best.

2. Next 50 minutes:
Do not exceed half throttle (approximately 3000 r/min). Vary engine speed occasionally. If you have an easy-planing boat, accelerate at full throttle onto plane, then immediately reduce the throttle to 3000 r/min or less.
3. Next two hours:
Accelerate at full throttle onto plane, then reduce engine speed to three-quarter throttle (approximately 4000 r/min). Vary engine speed occasionally. Run at full throttle for one minute, then allow about 10 minutes of operation at three-quarter throttle or less to let the engine cool.
4. Remaining seven hours:
Run the engine at any speed. However, avoid operating at full throttle for more than 5 minutes at a time.
5. After the first 10 hours:
Operate the engine normally. Use only straight gasoline in the fuel tank. The Yamaha oil injection system provides proper lubrication for normal operation.

EMU36400

Getting to know your boat

Different boats handle differently. Operate cautiously while you learn how your boat handles under different conditions and with different trim angles (see page 45).

EMU36413

Checks before starting engine

EWM01921

WARNING

If any item in “Checks before starting engine” is not working properly, have it inspected and repaired before operating the outboard motor. Otherwise, an accident could occur.

Operation

ECM00120

NOTICE

Do not start the engine out of water. Overheating and serious engine damage can occur.

EMU37151

Fuel level

Be sure you have plenty of fuel for your trip. A good rule is to use 1/3 of your fuel to get to the destination, 1/3 to return, and to keep 1/3 as an emergency reserve. With the boat level on a trailer or in the water, turn the key to "ON" (on) and check the fuel level. For fuel filling instructions, see page 36.

EMU36431

Remove cowling

For the following checks, remove the top cowling from the engine. To remove the engine cowling, release all the lock levers and lift off the cowling.

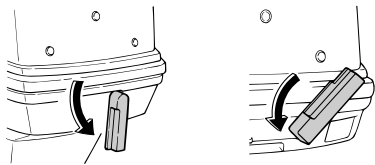

ZMU06093

EMU36442

Fuel system

EWM00060

WARNING

Gasoline and its vapors are highly flammable and explosive. Keep away from sparks, cigarettes, flames, or other sources of ignition.

EWM00910

WARNING

Leaking fuel can result in fire or explosion.

sion.

- Check for fuel leakage regularly.
- If any fuel leakage is found, the fuel system must be repaired by a qualified mechanic. Improper repairs can make the outboard unsafe to operate.

EMU36451

Check for fuel leaks

- Check for fuel leaks or gasoline fumes in the boat.
- Check for fuel leakage from the fuel system.
- Check the fuel tank and fuel lines for cracks, swellings, or other damages.

EMU37321

Checking the fuel filter

Check that the fuel filter is clean and free of water. If any water is found in the fuel, or if a significant amount of debris is found, the fuel tank should be checked and cleaned by a Yamaha dealer.

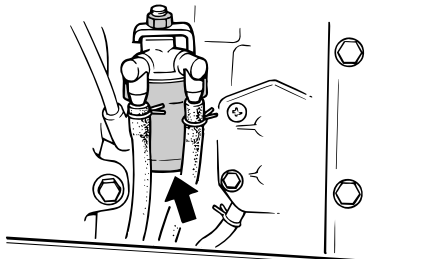

ZMU06184

EMU36902

Controls

Tiller handle models:

- Move the tiller handle fully to the left and right to make sure operation is smooth.
- Turn the throttle grip from the fully closed to the fully open position. Make sure that it turns smoothly and that it completely returns to the fully closed position.
- Look for loose or damaged connections of the throttle and shift cables.

Remote control models:

- Turn the steering wheel full-right and full-left. Make sure operation is smooth and unrestricted throughout the whole range with no binding or excessive free play.
- Operate the throttle levers several times to make sure there is no hesitation in their travel. Operation should be smooth over the complete range of motion, and each lever should return completely to the idle position.
- Look for loose or damaged connections of the throttle and shift cables.

EMU36483

Engine shut-off cord (lanyard)

Inspect the engine shut-off cord and clip for damage, such as cuts, breaks, and wear.

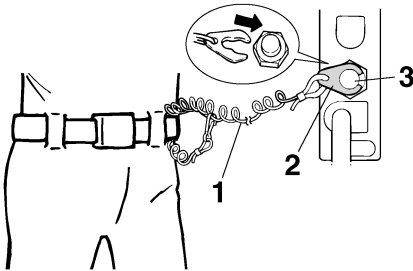

ZMU01716

1. Cord
2. Clip
3. Engine shut-off switch

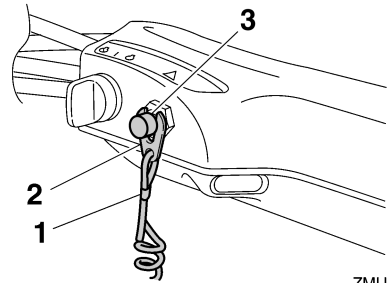

ZMU05208

1. Cord
2. Clip
3. Engine shut-off switch

EMU27120

Oil

- Check to be sure you have plenty of oil for your trip.

EMU27153

Engine

- Check the engine and engine mounting.
- Look for loose or damaged fasteners.
- Check the propeller for damage.
- Check for engine oil leaks.

EMU27181

Operation after long period of storage

Oil injection models

When operating the engine after a long period (12 months) of storage, proceed as follows:

1. Use a 50:1 gasoline to oil mixture to start the engine.
2. Start the engine. Leave it idling.
WARNING! Do not touch or remove electrical parts when starting or during operation. Keep hands, hair, and clothes away from the flywheel and other rotating parts while the engine is running. [EWM01331]
3. Watch for oil flowing through the oil feed pipes. After any air in the oil lines has

Operation

been expelled, the oil injection system should supply oil normally. If no oil is flowing after 10 minutes of idling, consult your Yamaha dealer.

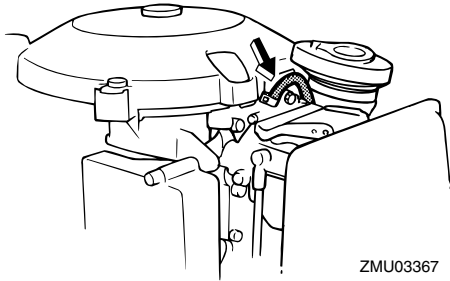

ECM01260

NOTICE

Be sure to take the above steps when operating the engine after a long period of storage. Otherwise engine seizure could occur.

EMU36492

Flushing device

Check that the flushing device's garden hose connector is securely screwed on to the fitting on the bottom cowling. **NOTICE: If the garden hose connector is not properly connected, cooling water can leak out and the engine can overheat during operation.** [ECM01801]

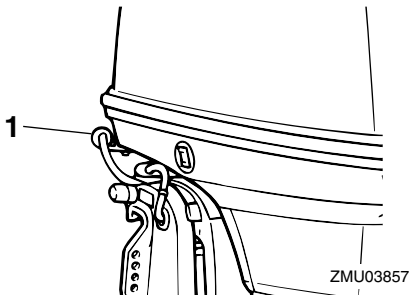

1. Flushing device

EMU36963

Install cowling

1. Be sure that all cowling lock levers are released.
2. Be sure that the rubber seal is seated all the way around the top cowling.
3. Place the top cowling on bottom cowling.
4. Check to be sure the rubber seal fits correctly all the way around the engine.
5. Move the levers to lock the cowling as shown. **NOTICE: If the top cowling is not installed correctly, water spray under the top cowling can damage the engine, or the top cowling can blow off at high speeds.** [ECM01991]

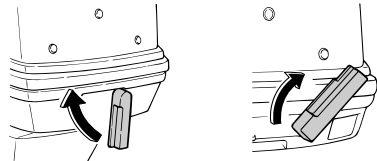

After installing, check the fitting of the top cowling by pushing it with both hands. If the top cowling is loose, have it repaired by your Yamaha dealer.

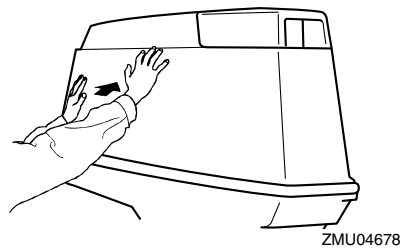

EMU29158

Checking power trim and tilt system

EWM01930

WARNING

- Never get under the lower unit while it is tilted, even when the tilt support lever is locked. Severe injury could occur if the outboard motor accidentally falls.
- Body parts can be crushed between the motor and the clamp bracket when the motor is trimmed or tilted.
- Be sure no one is near the outboard motor before performing this check.

1. Check the power trim and tilt unit for any sign of oil leaks.
2. Operate each of the power trim and tilt switches on the remote control and engine bottom cowling to check that all switches work.
3. Tilt the outboard motor up and check that the tilt rod and trim rods are extended completely.

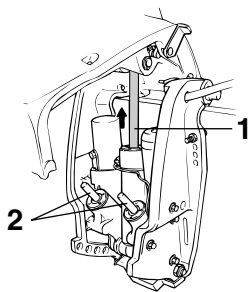

ZMU03531

1. Tilt rod
2. Trim rods

4. Use the tilt support lever to lock the motor in the up position. Operate the tilt down switch briefly so the motor is supported by the tilt support lever.

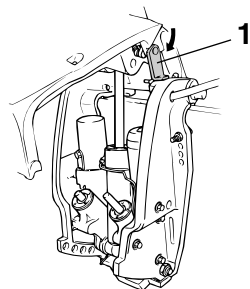

ZMU03533

1. Tilt support lever
5. Check that the tilt rod and trim rods are free of corrosion or other flaws.
6. Activate the tilt-down switch until the trim rods have retracted completely into the cylinders.

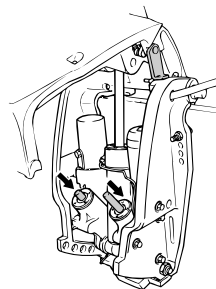

ZMU05037

7. Activate the trim-up switch until the tilt rod is fully extended. Unlock the tilt support lever.

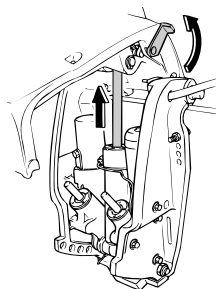

ZMU03532

8. Tilt the outboard motor down. Check that

Operation

the tilt rod and trim rods operate smoothly.

EMU36582

Battery

Check that the battery is in good condition, and fully charged. Check that the battery connections are clean, secure and covered by insulating covers. The electrical contacts of the battery and cables must be clean and properly connected or the battery will not start the engine.

Refer to the battery manufacturer's instructions for checks for your particular battery.

EMU27234

Filling fuel and engine oil

EMU27248

Filling fuel for portable tank

EWM01830

WARNING

- Gasoline and its vapors are highly flammable and explosive. Always refuel according to this procedure to reduce the risk of fire and explosion.
- Gasoline is poisonous and can cause injury or death. Handle gasoline with care. Never siphon gasoline by mouth. If you should swallow some gasoline or inhale a lot of gasoline vapor, or get some gasoline in your eyes, see your doctor immediately. If gasoline spills on your skin, wash with soap and water. If gasoline spills on your clothing, change your clothes.

1. Be sure the engine is stopped.
2. Disconnect the fuel line from the fuel tank and tighten the air vent screw on the fuel tank cap.

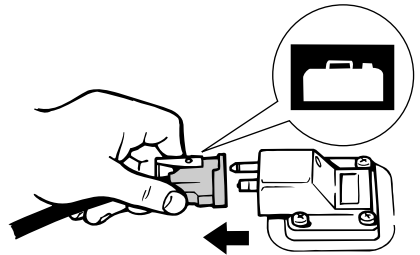

ZMU06621

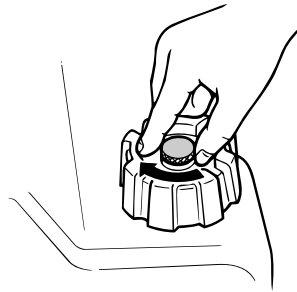

ZMU02301

3. Remove the portable tank from the boat.
4. Be sure you are in a well-ventilated outdoor area, either securely moored or trailered.
5. Do not smoke and keep away from sparks, flames, static electric discharge, or other sources of ignition.
6. If you use a portable container to store and dispense fuel, use only an approved GASOLINE container.
7. Touch the fuel nozzle to the filler opening or funnel to help prevent electrostatic sparks.
8. Fill the fuel tank, but do not overfill. **WARNING! Do not overfill. Otherwise fuel can expand and overflow if the temperature increases.** [EWM02610]

Fuel tank capacity:

24 L (6.34 US gal, 5.28 Imp.gal),
25 L (6.60 US gal, 5.50 Imp.gal)

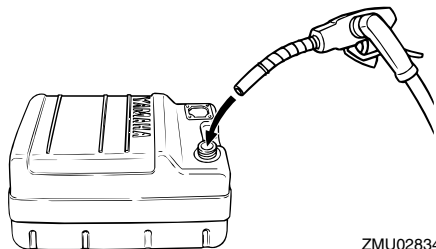

ZMU02834

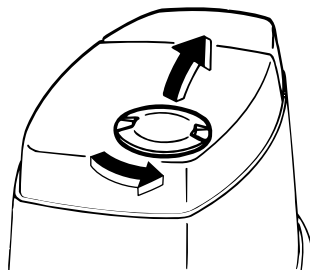

ZMU03369

9. Tighten the filler cap securely.
10. Wipe up any spilled gasoline immediately with dry rags. Dispose rags properly according to local laws or regulations.

EMU27311

Filling oil for electric start models

EWM00530



WARNING

Do not add gasoline into the oil tank. Fire or explosion could result.

This engine uses the Yamaha oil injection system, which provides superior lubrication by ensuring the proper oil ratio for all operating conditions. No fuel premixing is needed. Simply pour gasoline into the fuel tank and oil into the oil tank. Convenient indicator segments indicate the status of the oil supply. For details on reading the indicator segments, see page 38.

To fill the engine oil tank, proceed as follows:

Engine oil tank capacity: 3.3 L (3.49 US qt, 2.90 Imp.qt)
--

2. Open the oil tank filler cap by pulling the tab on the cap.

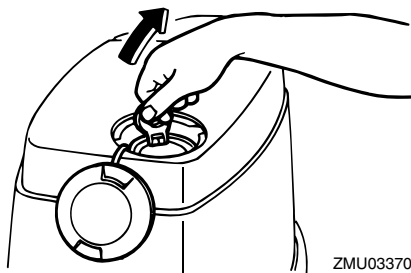

ZMU03370

3. Slowly pour the engine oil into the engine oil tank.

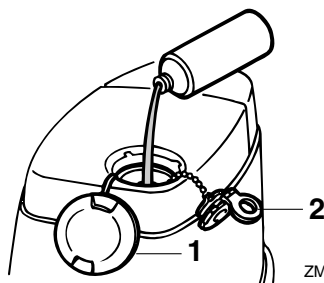

ZMU03371

1. Turn the oil filler access cap on the top cowling counterclockwise and open it.

1. Oil filler access cap
2. Oil tank filler cap

4. After filling, replace the all caps securely.

Operation









EMU27321

Oil level indicator operation

The various functions of the oil level system are as follows:

EMU27372

Electric start models

Oil level-alert indicator (digital tachometer)	Oil level-alert indicator (analog tachometer/ bottom cowling)	Engine oil tank	Remarks
	Green 	 more than 1130 cm ³ (1.19 US qt, 0.99 Imp qt)	No refilling necessary.
	Yellow 	 from 1130 cm ³ (1.19 US qt, 0.99 Imp qt) down to 310 cm ³ (0.33 US qt, 0.27 Imp qt)	Add oil; see page 37.
	Red 	 310 cm ³ (0.33 US qt, 0.27 Imp qt) or less	<ul style="list-style-type: none"> ● Buzzer sounds in remote control box and engine speed is limited to about 2000 r/min to help conserve oil. ● Check oil filter for clogging.

EMU27452

Operating engine

EWM00420

WARNING

- Before starting the engine, make sure that the boat is tightly moored and that you can steer clear of any obstructions. Be sure there are no swimmers in the water near you.
- When the air vent screw is loosened, gasoline vapor will be released. Gasoline is highly flammable, and its vapors are flammable and explosive. Refrain from smoking, and keep away from

open flames and sparks while loosening the air vent screw.

- This product emits exhaust gases which contain carbon monoxide, a colorless, odorless gas which could cause brain damage or death when inhaled. Symptoms include nausea, dizziness, and drowsiness. Keep cockpit and cabin areas well ventilated. Avoid blocking exhaust outlets.

EMU35704

Sending fuel (portable tank)

1. If there is an air vent screw on the fuel tank cap, loosen it 2 or 3 turns.

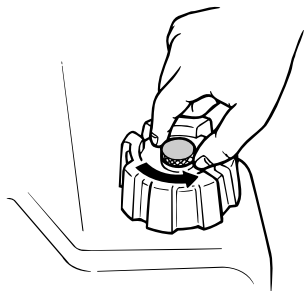

ZMU02295

2. If there is a fuel joint on the motor, align the fuel joint on the fuel line with the fuel joint on the motor and firmly connect the fuel line to the joint while pinching the joint. Then firmly connect the other end of the fuel line to the joint on the fuel tank.

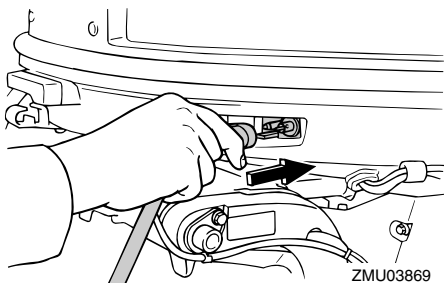

ZMU03869

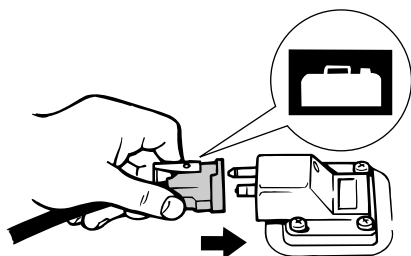

ZMU02024

TIP:

Wipe up any spilled gasoline immediately with dry rags. Dispose rags properly according to local laws or regulations.

3. If a steering friction adjuster is provided on your outboard motor, securely attach the fuel line to the fuel line clamp.
4. Squeeze the primer pump, with the arrow pointing up, until you feel it become firm. During engine operation place the tank horizontally, otherwise fuel cannot be drawn from the fuel tank.

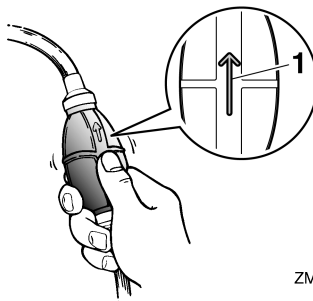

ZMU02025

1. Arrow

EMU27493

Starting engine

EWM01600



WARNING

Before starting the engine, make sure that the boat is tightly moored and that you can steer clear of any obstructions. Be sure there are no swimmers in the water near you.

EMU27595

Electric start / prime start models

EWM01840



WARNING

- Failure to attached engine shut-off cord could result in a runaway boat if operator is ejected. Attach the engine shut-off cord to a secure place on your clothing, or your arm or leg while operating. Do not attach the cord to clothing that could tear loose. Do not route the cord where it could become entangled, pre-

Operation

venting it from functioning.

- **Avoid accidentally pulling the cord during normal operation. Loss of engine power means the loss of most steering control. Also, without engine power, the boat could slow rapidly. This could cause people and objects in the boat to be thrown forward.**

1. Place the gear shift lever in neutral.

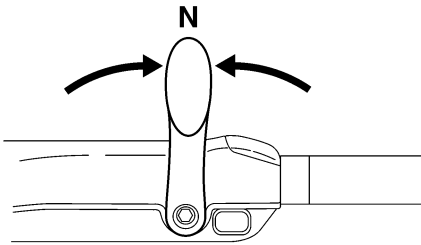

ZMU05215

TIP:

The start-in-gear protection device prevents the engine from starting except when in neutral.

2. Attach the engine shut-off cord to a secure place on your clothing, or your arm or leg. Then install the clip on the other end of the cord into the engine shut-off switch.

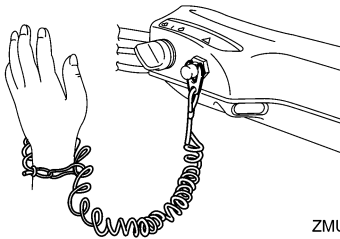

ZMU05216

3. Place the throttle grip in the “START” (start) position. After the engine starts,

return the throttle to the fully closed position.

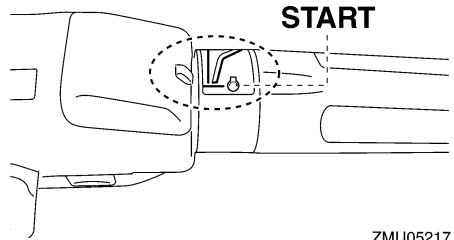

ZMU05217

4. Turn the main switch to “START” (start), and hold it for a maximum of 5 seconds.

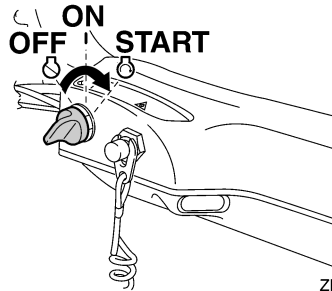

ZMU05218

5. Immediately after the engine starts, release the main switch and allow it to return to “ON” (on). **NOTICE: Never turn the main switch to “START” (start) while the engine is running. Do not keep the starter motor turning for more than 5 seconds. If the starter motor is turned continuously for more than 5 seconds, the battery will be quickly discharged, thus making it impossible to start the engine. The starter can also be damaged. If the engine will not start after 5 seconds of cranking, return the main switch to “ON” (on), wait 10 seconds, then crank the engine again.** [ECM00192]

TIP:

- When the engine is cold, it needs to be warmed up. For further information, see page 42.
- If the engine is warm and fails to start, open the throttle slightly and try to start the engine again. If the engine still fails to start, see page 68.

EMU27664

Electric start and remote control models

EWM01840

WARNING

- Failure to attached engine shut-off cord could result in a runaway boat if operator is ejected. Attach the engine shut-off cord to a secure place on your clothing, or your arm or leg while operating. Do not attach the cord to clothing that could tear loose. Do not route the cord where it could become entangled, preventing it from functioning.
- Avoid accidentally pulling the cord during normal operation. Loss of engine power means the loss of most steering control. Also, without engine power, the boat could slow rapidly. This could cause people and objects in the boat to be thrown forward.

1. Place the remote control lever in neutral.

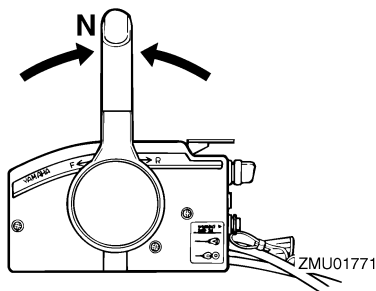

TIP:

The start-in-gear protection device prevents

the engine from starting except when in neutral.

2. Attach the engine shut-off cord to a secure place on your clothing, or your arm or leg. Then install the clip on the other end of the cord into the engine shut-off switch.

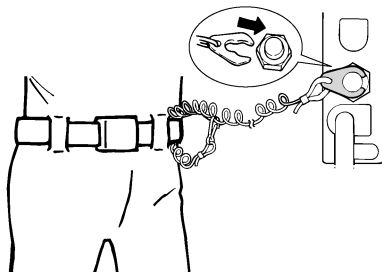

ZMU01772

3. Turn the main switch to "ON" (on).
4. Turn the main switch to "START" (start), and hold it for a maximum of 5 seconds.

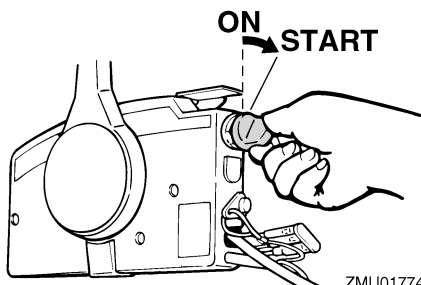

ZMU01774

5. Immediately after the engine starts, release the main switch and allow it to return to "ON" (on). **NOTICE: Never turn the main switch to "START" (start) while the engine is running. Do not keep the starter motor turning for more than 5 seconds. If the starter motor is turned continuously for more than 5 seconds, the battery will be quickly discharged, thus making it impossible to start the engine. The**

Operation

starter can also be damaged. If the engine will not start after 5 seconds of cranking, return the main switch to “ON” (on), wait 10 seconds, then crank the engine again. [ECM00192]

TIP:

- When the engine is cold, it needs to be warmed up. For further information, see page 42.
- If the engine is warm and fails to start, open the throttle slightly and try to start the engine again. If the engine still fails to start, see page 68.

EMU36510

Checks after starting engine

EMU36522

Cooling water

Check for a steady flow of water from the cooling water pilot hole. A continuous flow of water from the pilot hole indicates that the water pump is pumping water through the cooling water passages. If the cooling water passages are frozen, it may take a while for water to start flowing out of the pilot hole.

ECM01810

NOTICE

If water is not flowing out of the pilot hole at all times while the engine is running, overheating and serious damage could occur. Stop the engine and check whether the cooling water inlet on the lower case or the cooling water pilot hole is blocked. Consult your Yamaha dealer if the problem cannot be located and corrected.

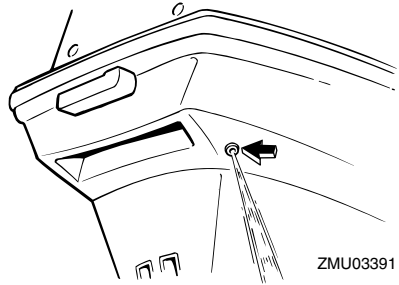

EMU27670

Warming up engine

EMU27704

Electric start and prime start models

After starting the engine, allow it to idle for 3 minutes to warm up. Failure to do so will shorten engine life.

EMU36531

Checks after engine warm up

EMU36541

Shifting

While the boat is tightly moored, and without applying throttle, confirm that the engine shifts smoothly into forward and reverse, and back to neutral.

EMU36980

Stop switches

- Turn the main switch to “OFF”, or press the engine stop button and make sure the engine stops.
- Confirm that removing the clip from the engine shut-off switch stops the engine.
- Confirm that the engine cannot be started with the clip removed from the engine shut-off switch.

EMU33492

Shifting

EWMM00180



Before shifting, make sure there are no swimmers or obstacles in the water near you.

ECM01610

NOTICE

Warm up the engine before shifting into gear. Until the engine is warm, the idle speed may be higher than normal. High idle speed can prevent you from shifting back to neutral. If this occurs, stop the engine, shift to neutral, then restart the engine and allow it to warm up.

To shift out of neutral

1. Pull the neutral interlock trigger up (if equipped).

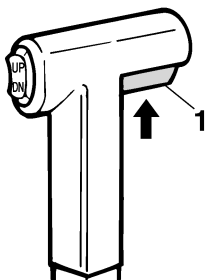

ZMU01727

1. Neutral interlock trigger

2. Move the remote control lever / gear shift lever firmly and crisply forward (for forward gear) or backward (for reverse gear) [about 35° (a detent can be felt) for remote control models].

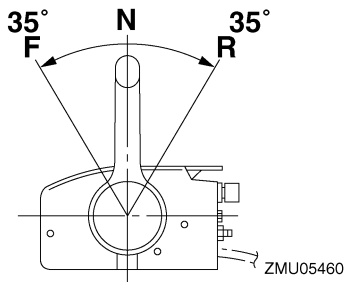

ZMU05460

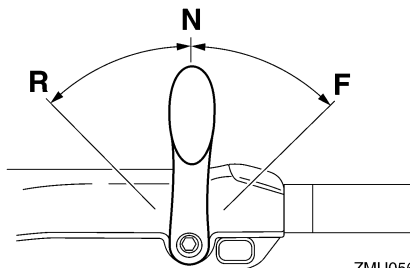

ZMU05674

To shift from in gear (forward/reverse) to neutral

1. Close the throttle so that the engine slows to idle speed.

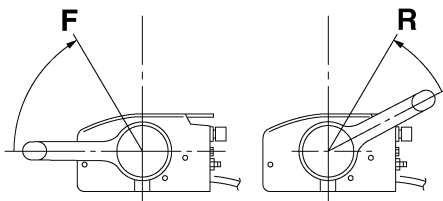

ZMU05462

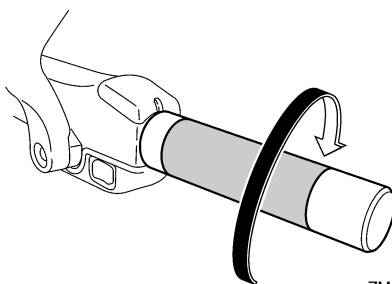

ZMU05219

2. After the engine is at idle speed in gear move the remote control lever / gear shift lever firmly and crisply into the neutral position.

Operation

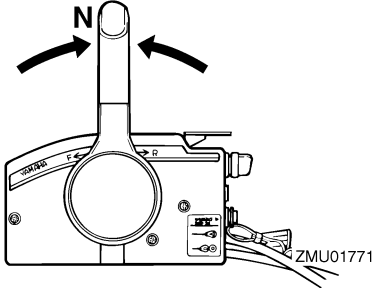

EMU27821

Stopping engine

Before stopping the engine, first let it cool off for a few minutes at idle or low speed. Stopping the engine immediately after operating at high speed is not recommended.

EMU27847

Procedure

1. Push and hold the engine stop button or turn the main switch to “OFF” (off).

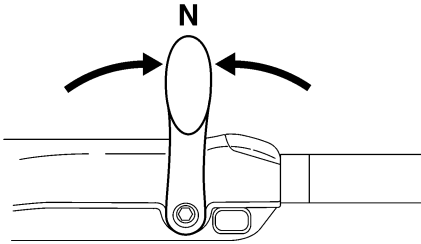

ZMU05215

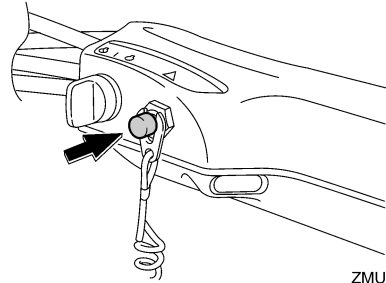

ZMU05209

EMU31742

Stopping boat

EWM01510

WARNING

- Do not use the reverse function to slow down or stop the boat as it could cause you to lose control, be ejected, or impact the steering wheel or other parts of the boat. This could increase the risk of serious injury. It could also damage the shift mechanism.
- Do not shift into reverse while traveling at planing speeds. Loss of control, boat swamping, or damage to the boat could occur.

The boat is not equipped with a separate braking system. Water resistance stops it after the throttle lever is moved back to idle. The stopping distance varies depending on gross weight, water surface conditions, and wind direction.

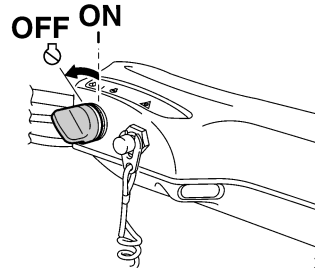

ZMU05223

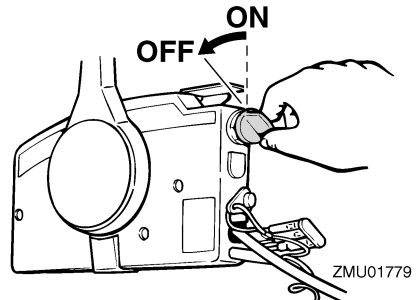

ZMU01779

2. After stopping the engine, disconnect

the fuel line if there is a fuel joint on the outboard motor.

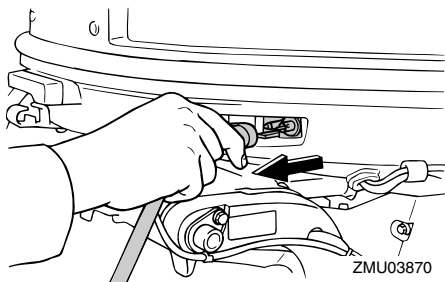

3. Tighten the air vent screw on the fuel tank cap (if equipped).

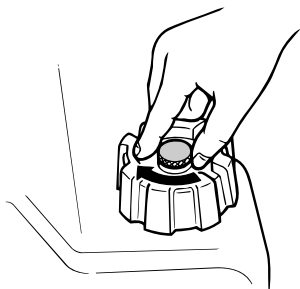

4. Remove the key if the boat will be left unattended.

TIP:

The engine can also be stopped by pulling the cord and removing the clip from the engine shut-off switch, then turning the main switch to "OFF" (off).

EMU27862

Trimming outboard motor

EWM00740

WARNING

Excessive trim for the operating conditions (either trim up or trim down) can cause boat instability and can make steering the boat more difficult. This increases the possibility of an accident. If the boat begins to feel unstable or is hard

to steer, slow down and/or readjust the trim angle.

The trim angle of the outboard motor helps determine the position of the bow of the boat in the water. Correct trim angle will help improve performance and fuel economy while reducing strain on the engine. Correct trim angle depends upon the combination of boat, engine, and propeller. Correct trim is also affected by variables such as the load in the boat, sea conditions, and running speed.

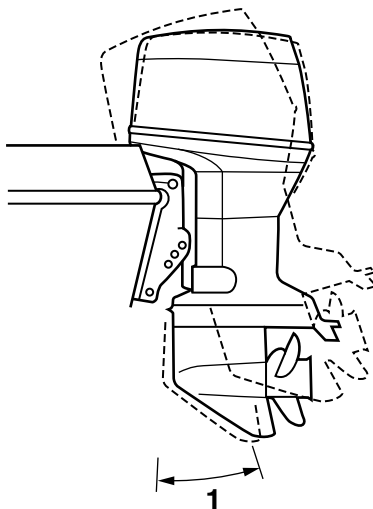

ZMU03109

1. Trim operating angle

EMU27885

Adjusting trim angle (Power trim and tilt)

EWM00753

WARNING

- Be sure all people are clear of the outboard motor when adjusting the trim angle. Body parts can be crushed be-

Operation

tween the motor and the clamp bracket when the motor is trimmed or tilted.

- Use caution when trying a trim position for the first time. Increase speed gradually and watch for any signs of instability or control problems. Improper trim angle can cause loss of control.
- If equipped with a power trim and tilt switch located on the bottom cowling, use the switch only when the boat is at a complete stop with the engine off. Do not adjust the trim angle with this switch while the boat is moving.

Adjust the outboard motor trim angle using the power trim and tilt switch.

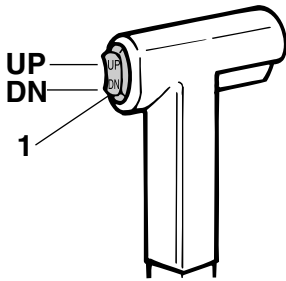

ZMU03110

1. Power trim and tilt switch

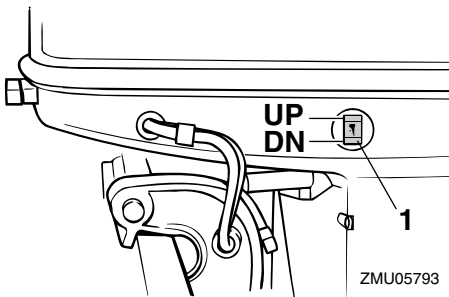

ZMU05793

1. Power trim and tilt switch

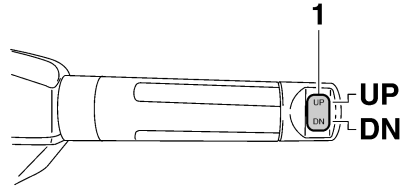

ZMU05224

1. Power trim and tilt switch

To raise the bow (trim-out), press the switch "UP" (up).

To lower the bow (trim-in), press the switch "DN" (down).

Make test runs with the trim set to different angles to find the position that works best for your boat and operating conditions.

EMU27912

Adjusting boat trim

When the boat is on plane, a bow-up attitude results in less drag, greater stability and efficiency. This is generally when the keel line of the boat is up about 3 to 5 degrees. With the bow up, the boat may have a greater tendency to steer to one side or the other. Compensate for this as you steer. When the bow of the boat is down, it is easier to accelerate from a standing start onto plane.

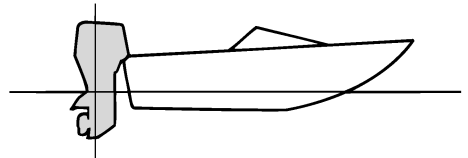

ZMU01784

Bow Up

Too much trim-out puts the bow of the boat too high in the water. Performance and economy are decreased because the hull of the boat is pushing the water and there is more air drag. Excessive trim-out can also cause the propeller to ventilate, which reduces performance further, and the boat may “porpoise” (hop in the water), which could throw the operator and passengers overboard.

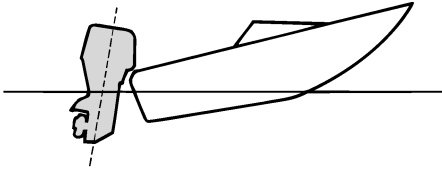

ZMU01785

Bow Down

Too much trim-in causes the boat to “plow” through the water, decreasing fuel economy and making it hard to increase speed. Operating with excessive trim-in at higher speeds also makes the boat unstable. Resistance at the bow is greatly increased, heightening the danger of “bow steering” and making operation difficult and dangerous.

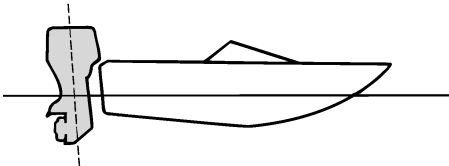

ZMU01786

TIP:

Depending on the type of boat, the outboard

motor trim angle may have little effect on the trim of the boat when operating.

EMU27935

Tilting up and down

If the engine will be stopped for some time or if the boat is moored in shallows, the outboard motor should be tilted up to protect the propeller and lower casing from damage by collision with obstructions, and also to reduce salt corrosion.

EWM00222

WARNING

Make sure that no one is near the outboard motor when tilting the outboard motor up or down. Otherwise, body parts could be crushed between the outboard motor and the clamp bracket.

EWM00250

WARNING

Leaking fuel is a fire hazard. If there is a fuel joint on the outboard motor, disconnect the fuel line or close the fuel cock if the engine will be tilted for more than a few minutes. Otherwise fuel may leak.

ECM00241

NOTICE

- Before tilting the outboard motor, stop the engine by following the procedure on page 44. Never tilt the outboard motor while the engine is running. Severe damage from overheating can result.
- Do not tilt up the engine by pushing the tiller handle (if equipped) because this could break the handle.

EMU32724

Procedure for tilting up (power trim and tilt models)

1. Place the remote control lever / gear shift lever in neutral.

Operation

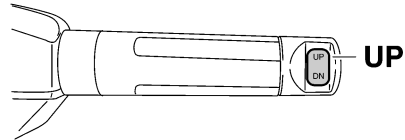
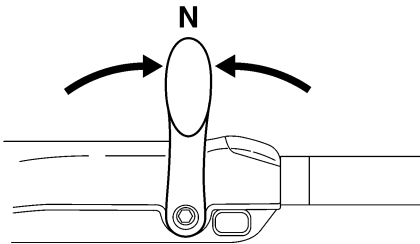
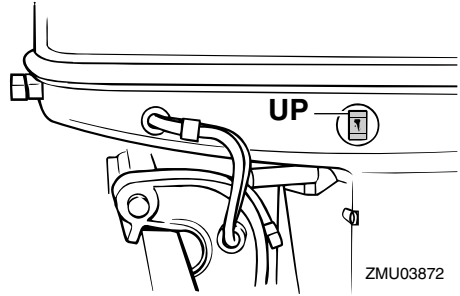
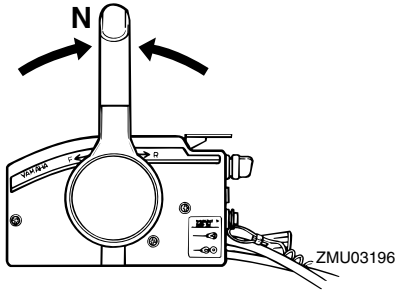

2. Press the power trim and tilt switch “UP” (up) until the outboard motor has tilted up completely.

3. Pull the tilt support lever toward you to support the engine. **WARNING!** After tilting the outboard motor, be sure to support it with the tilt support knob or tilt support lever. Otherwise the outboard motor could fall back down suddenly if oil in the power trim and tilt unit or in the power tilt unit loses pressure. [EWM00262] **NOTICE:** Do not use the tilt support lever or knob when trailering the boat. The outboard motor could shake loose from the tilt support and fall. If the motor cannot be trailered in the normal running position, use an additional support device to secure it in the tilt position. For more detailed information, see page 52. [ECM01641]

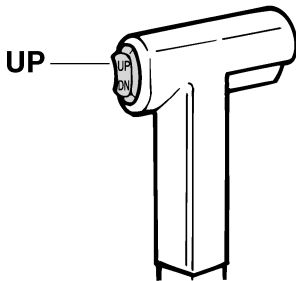

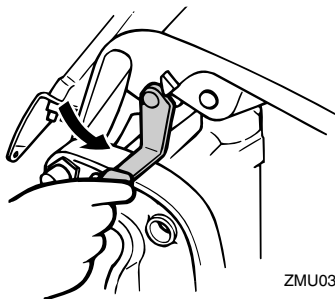

ZMU03115

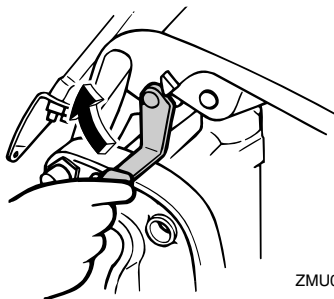

ZMU03875

4. Models equipped with trim rods: Once the outboard motor is supported with the tilt support lever, press the power trim and tilt switch “DN” (down) to retract the trim rods. **NOTICE: Make sure that the trim rods retract completely during mooring. This protects the rods from marine growth and corrosion, which could damage the power trim and tilt mechanism.** [ECM00252]
3. Push the power trim and tilt switch “DN” (down) to lower the outboard motor to the desired position.

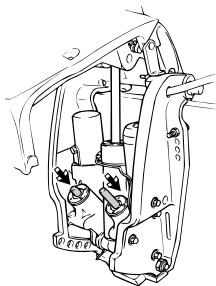

ZMU03874

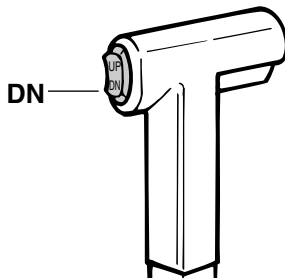

ZMU01936

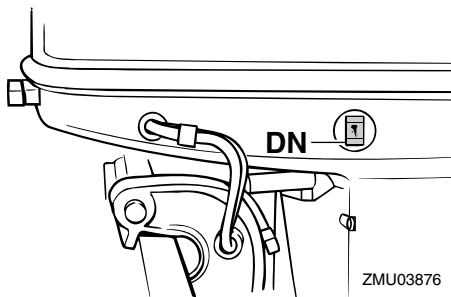

ZMU03876

EMU33121

Procedure for tilting down (power trim and tilt models)

1. Push the power trim and tilt switch “UP” (up) until the outboard motor is supported by the tilt rod and the tilt support lever becomes free.
2. Release the tilt support lever.

Operation

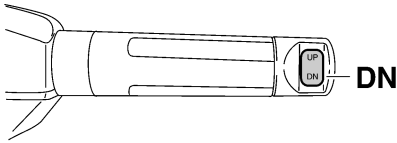

ZMU05228

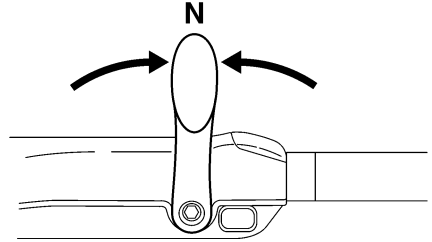

ZMU05215

EMU28061

Shallow water

EMU32851

Power trim and tilt models

The outboard motor can be tilted up partially to allow operation in shallow water.

ECM00260

NOTICE

Do not tilt the outboard motor up so that the cooling water inlet on the lower unit is above the surface of the water when setting up for and cruising in shallow water. Otherwise severe damage from overheating can result.

EMU32913

Procedure for power trim and tilt models

1. Place the remote control lever / gear shift lever in neutral.

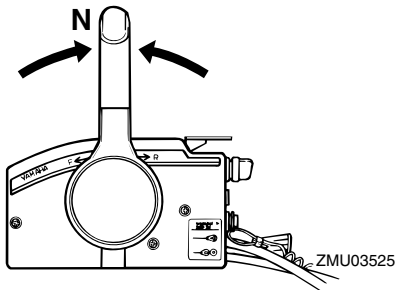

ZMU03525

2. Slightly tilt the outboard motor up to the desired position using the power trim and tilt switch. **WARNING! Using the power trim and tilt switch on the bottom cowling while the boat is moving or engine is on could increase the risk of falling overboard and could distract the operator, increasing the risk of collision with another boat or an obstacle.** [EWM01850]

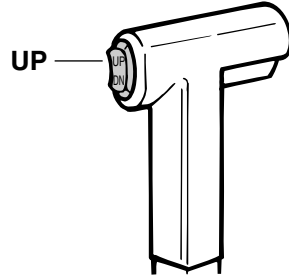

ZMU01935

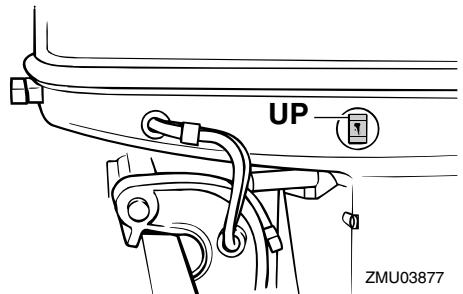

ZMU03877

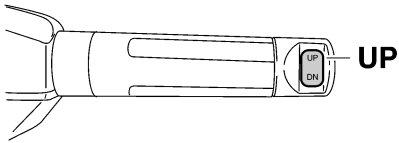

ZMU05226

3. To return the outboard motor to the normal running position, press the power trim and tilt switch and slowly tilt the outboard motor down.

EMU28195

Cruising in other conditions

Cruising in salt water

After operating in salt water, flush the cooling water passages with fresh water to prevent them from becoming clogged. Also rinse the outside of the outboard motor with fresh water.

Cruising in muddy, turbid, or acidic water

Yamaha strongly recommends that you use the optional chromium-plated water pump kit (see page 12) if you use the outboard motor in acidic water or water with a lot of sediment in it, such as muddy or turbid (cloudy) water. After operating in such water, flush the cooling passages with fresh water to prevent corrosion. Also rinse the outside of the outboard motor with fresh water.

Maintenance

EMU2822A

Transporting and storing outboard motor

EWM02620

WARNING

- **USE CARE** when transporting fuel tank, whether in a boat or car.
- **DO NOT** fill fuel container to maximum capacity. Gasoline will expand considerably as it warms up and can build up pressure in the fuel container. This can cause fuel leakage and a potential fire hazard.
- **Leaking fuel is a fire hazard. When transporting and storing the outboard motor, disconnect the fuel line from the outboard motor to prevent fuel from leaking.**
- **Never get under the outboard motor while it is tilted. Severe injury could occur if the outboard motor accidentally falls.**
- **Do not use the tilt support lever or knob when trailering the boat. The outboard motor could shake loose from the tilt support and fall. If the outboard motor cannot be trailered in the normal running position, use an additional support device to secure it in the tilt position.**

ECM02440

NOTICE

When storing the outboard motor for prolonged time, fuel must be drained from the fuel tank. The deteriorated fuel could clog the fuel line causing engine start difficulty or malfunction.

When storing or transporting the outboard motor, make sure to follow the procedure listed below.

- Disconnect the fuel line from the outboard motor.
- Tighten the fuel tank cap and its air vent screw.
- When the outboard motor is tilted prolonged time for mooring or trailering the boat, disconnect the fuel line from the outboard motor. Tighten the fuel tank cap and its air vent screw.

The outboard motor should be transported and stored in the normal running position. If there is insufficient road clearance in this position, then trailer the outboard motor in the tilt position using a motor support device such as a transom saver bar. Consult your Yamaha dealer for further details.

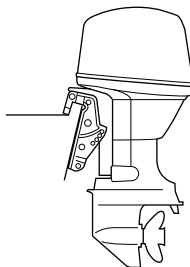

ZMU03659

EMU30272

Storing outboard motor

When storing your Yamaha outboard motor for prolonged periods of time (2 months or longer), several important procedures must be performed to prevent excessive damage. It is advisable to have your outboard motor serviced by an authorized Yamaha dealer prior to storage. However, you, the owner, with a minimum of tools, can perform the following procedures.

ECM01411

NOTICE

- **Do not place the outboard motor on its side before the cooling water has**

drained from it completely, otherwise water may enter the cylinder through the exhaust port and cause engine trouble.

- Store the outboard motor in a dry, well-ventilated place, not in direct sunlight.

EMU28305

Procedure

EMU28323

Flushing with the flushing attachment

Flushing with the flushing attachment

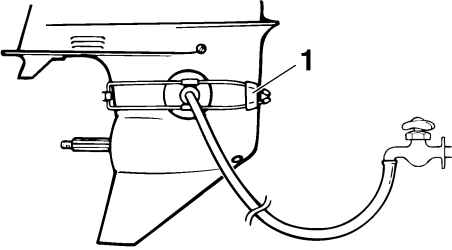
1. Wash the outboard motor body using fresh water. **NOTICE: Do not spray water into the air intake.** [ECM01840] For further information, see page 55.
 2. Disconnect the fuel line from the motor or shut off the fuel cock, if equipped.
 3. Remove the engine top cowling and silencer cover. Remove the propeller.
 4. Install the flushing attachment over the cooling water inlet. **NOTICE: Do not run the engine without supplying it with cooling water. Either the engine water pump will be damaged or the engine will be damaged from overheating. Before starting the engine, be sure to supply water to the cooling water passages. Avoid running the outboard motor at high speed while on the flushing attachment, otherwise overheating could occur.** [ECM02000]
- 
- ZMU01830
5. Flushing attachment
 5. Cooling system flushing is essential to prevent the cooling system from clogging up with salt, sand, or dirt. In addition, fogging/lubricating of the engine is mandatory to prevent excessive engine damage due to rust. Perform the flushing and fogging at the same time. **WARNING! Do not touch or remove electrical parts when starting or during operation. Keep hands, hair, and clothes away from the flywheel and other rotating parts while the engine is running.** [EWM00091]
 6. Run the engine at a fast idle for a few minutes in neutral position.
 7. Just prior to turning off the engine, quickly spray "Fogging Oil" alternately into each carburetor or the fogging hole of the silencer cover, if equipped. When properly done, the engine will smoke excessively and almost stall.
 8. Remove the flushing attachment.
 9. Install the silencer cover/cap of fogging hole and top cowling.
 10. If the "Fogging Oil" is not available, run the engine at a fast idle until the fuel system becomes empty and the engine stops.
 11. Drain the cooling water completely out of

Maintenance

the motor. Clean the body thoroughly.

12. If the "Fogging Oil" is not available, remove the spark plug(s). Pour a teaspoonful of clean engine oil into each cylinder. Crank several times manually. Replace the spark plug(s).

TIP:

A flushing attachment is available from your Yamaha dealer.

EMU28411

Lubrication (oil injection models)

1. Install the spark plug(s) and torque to proper specification. For information on spark plug installation, see page 60.
2. Fill the oil tanks. This prevents the formation of condensation. For models with a remote oil tank, it may be necessary to manually override the control unit to completely fill the engine oil tank.
3. Change the gear oil. For instructions, see page 64. Inspect the oil for the presence of water which indicates a leaky seal. Seal replacement should be performed by an authorized Yamaha dealer prior to use.
4. Grease all grease fittings. For further details, see page 60.

TIP:

For long-term storage, fogging the engine with oil is recommended. Contact your Yamaha dealer for information about fogging oil and procedures for your engine.

EMU28444

Flushing power unit

Perform this procedure right after operation for the most thorough flushing.

ECM01530

NOTICE

Do not perform this procedure while the engine is running. The water pump may be damaged and severe damage from

overheating can result.

1. After shutting off the engine, unscrew the garden hose connector from the fitting on the bottom cowling.

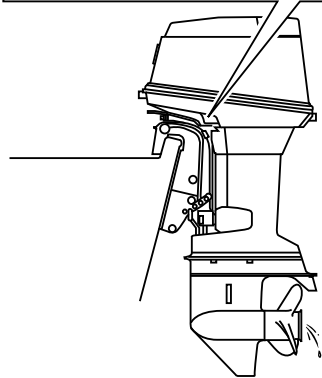
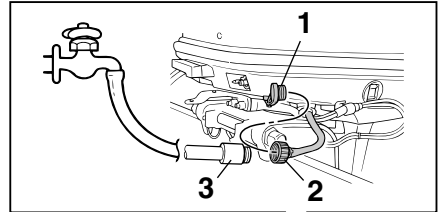

ZMU04697

1. Fitting
 2. Garden hose adapter
 3. Garden hose connector
2. Screw the garden hose adapter onto a garden hose, which is connected to a fresh water supply, and then connect it to the garden hose connector.
 3. With the engine off, turn on the water tap and let the water flush through the cooling passages for about 15 minutes. Turn off the water and disconnect the garden hose adapter from the garden hose connector.
 4. Reinstall the garden hose connector onto the fitting on the bottom cowling. Tighten the connector securely.

NOTICE: Do not leave the garden hose connector loose on the bottom cowling fitting or let the hose hang free during normal operation. Water will leak out of the connector instead of cooling the engine, which can cause serious overheating. Be sure the connector is tightened securely on the fitting after flushing the engine. [ECM00541]

TIP:

- When flushing the engine with the boat in the water, tilting up the outboard motor until it is completely out of the water will achieve better results.
- For cooling system flushing instructions, see page 52.

EMU28451

Cleaning the outboard motor

After use, wash the exterior of the outboard motor with fresh water. Flush the cooling system with fresh water.

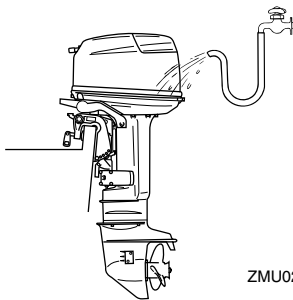

ZMU02988

EMU28461

Checking painted surface of outboard motor

Check the outboard motor for scratches, nicks, or flaking paint. Areas with damaged paint are more likely to corrode. If necessary, clean and paint the areas. A touch-up paint is available from your Yamaha dealer.

EMU2847C

Periodic maintenance

EWMO1871



WARNING

These procedures require mechanical skills, tools, and supplies. If you do not have the proper skills, tools, or supplies to perform a maintenance procedure, have a Yamaha dealer or other qualified mechanic do the work.

The procedures involve disassembling the motor and exposing dangerous parts. To reduce the risk of injury from moving, hot, or electrical parts:

- Turn off the engine and keep the key(s) and engine shut-off cord (lanyard) with you when you perform maintenance unless otherwise specified.
- The power trim and tilt switches operate even when the ignition key is off. Keep people away from the switches whenever working around the motor. When the motor is tilted, keep away from the area under it or between it and the clamp bracket. Be sure no one is in this area before operating the power trim and tilt mechanism.
- Allow the engine to cool before handling hot parts or fluids.
- Always completely reassemble the motor before operation.

EMU28511

Replacement parts

If replacement parts are necessary, use only genuine Yamaha parts or parts of equivalent design and quality. Any part of inferior quality may malfunction, and the resulting loss of control could endanger the operator and passengers. Yamaha genuine parts and accessories are available from your Yamaha dealer.

Maintenance

EMU34151

Severe operating conditions

Severe operating conditions involve one or more of the following types of operation on a regular basis:

- Operating continuously at or near maximum engine speed (rpm) for many hours
- Operating continuously at a low engine speed (rpm) for many hours
- Operating without sufficient time for engine to warm up and cool down
- Frequent quick acceleration and deceleration
- Frequent shifting
- Frequently starting and stopping the engine(s)
- Operation that fluctuates often between light and heavy cargo loads

Outboard motors operating under any of these above conditions require more frequent maintenance. Yamaha recommends that you do this service twice as often as specified in the maintenance chart. For example, if a particular service should be done at 50 hours, do it instead at 25 hours. This will help prevent more rapid deterioration of engine components.

EMU34446

Maintenance chart 1

TIP:

- Refer to the sections in this chapter for explanations of each owner-specific action.
- The maintenance cycle on these charts assume usage of 100 hours per year and regular flushing of the cooling water passages. Maintenance frequency should be adjusted when operating the engine under adverse conditions such as extended trolling.
- Disassembly or repairs may be necessary depending on the outcome of maintenance checks.
- Expendable or consumable parts and lubricants will lose their effectiveness over time and through normal usage regardless of the warranty period.
- When operating in salt water, muddy, other turbid (cloudy), acidic water, the engine should be flushed with clean water after each use.

The “●” symbol indicates the check-ups which you may carry out yourself.

The “○” symbol indicates work to be carried out by your Yamaha dealer.

Item	Actions	Initial	Every		
		20 hours (3 months)	100 hours (1 year)	300 hours (3 years)	500 hours (5 years)
Anode(s) (external)	Inspection or replacement as necessary		●/○		
Anode(s) (cylinder head, thermostat cover)	Inspection or replacement as necessary				○
Anodes (exhaust cover, cooling water passage cover, Rectifier Regulator cover)	Replacement				○
Battery (electrolyte level, terminal)	Inspection	●/○	●/○		
Battery (electrolyte level, terminal)	Fill, charging or replacing as necessary		○		
Cooling water leakage	Inspection or replacement as necessary	○	○		
Cowling lock lever	Inspection		●/○		
Engine starting condition/noise	Inspection	●/○	●/○		
Engine idle speed/noise	Inspection	●/○	●/○		
Fuel filter (can be disassembled)	Inspection or replacement as necessary	●/○	●/○		
Fuel line (High pressure)	Inspection	●	●		

Maintenance

Item	Actions	Initial	Every		
		20 hours (3 months)	100 hours (1 year)	300 hours (3 years)	500 hours (5 years)
Fuel line (High pressure)	Inspection or replacement as necessary	○	○		
Fuel line (Low pressure)	Inspection	●	●		
Fuel line (Low pressure)	Inspection or replacement as necessary	○	○		
Fuel pump	Inspection or replacement as necessary			○	
Fuel/engine oil leakage	Inspection	○	○		
Gear oil	Replacement	●/○	●/○		
Greasing points	Greasing	●/○	●/○		
Impeller/water pump housing	Inspection or replacement as necessary		○		
Impeller/water pump housing	Replacement			○	
Oil tank water drain	Inspection or cleaning	●/○	●/○		
Oil injection pump/oil feed pump	Inspection or Adjustment	○	○		
Power trim and tilt unit/Operation, noise and oil leakage	Inspection	●/○	●/○		
Propeller/propeller nut/cotter pin	Inspection or replacement as necessary	●/○	●/○		
PCV (Pressure Control Valve)	Inspection or replacement as necessary		○		
Shift link/shift cable	Inspection, adjustment or replacement as necessary	○	○		
Spark plug(s)	Inspection or replacement as necessary		●/○		
Spark plug caps/spark plug wires	Inspection or replacement as necessary	○	○		
Water from the cooling water pilot hole	Inspection	●/○	●/○		
Throttle link/throttle cable/throttle pick-up timing	Inspection, adjustment or replacement as necessary	○	○		
Thermostat	Inspection or replacement as necessary		○		

Maintenance

Item	Actions	Initial	Every		
		20 hours (3 months)	100 hours (1 year)	300 hours (3 years)	500 hours (5 years)
Cooling water inlet	Inspection	●/○	●/○		
Main switch/stop switch/choke switch	Inspection or replacement as necessary	○	○		
Wire harness connections/wire coupler connections	Inspection or replacement as necessary	○	○		
(Yamaha) Meter/gauge	Inspection	○	○		
Fuel tank (Yamaha portable tank)	Inspection and cleaning as necessary		○		

EMU34451

Maintenance chart 2

Item	Actions	Every
		1000 hours
Exhaust guide/exhaust manifold	Inspection or replacement as necessary	○

Maintenance

EMU28943

Greasing

Yamaha grease A (water resistant grease)

Yamaha grease D (corrosion resistant grease; for propeller shaft)

75C, 90A

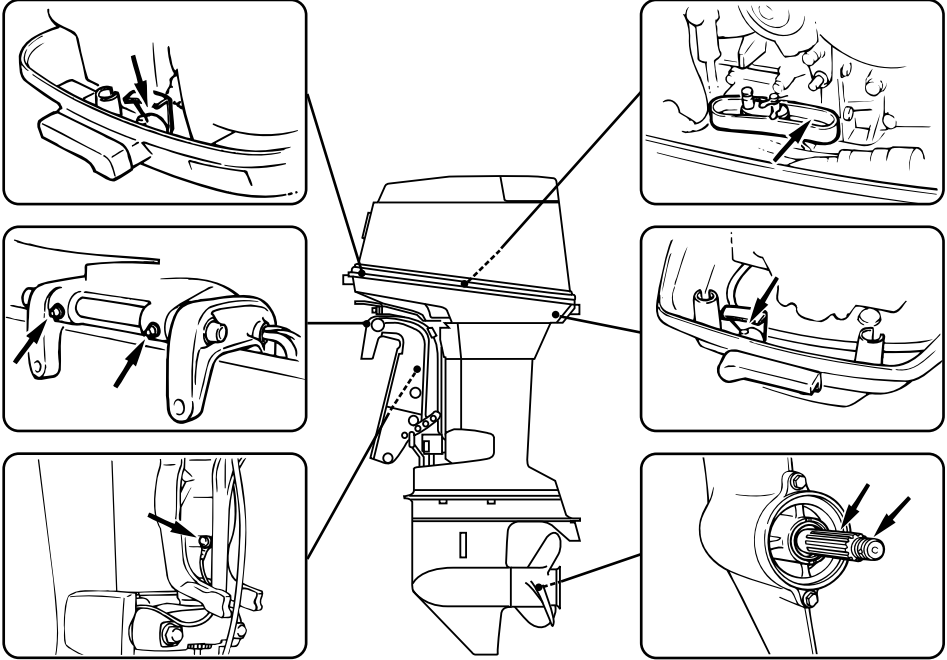

ZMU03879

EMU28957

Cleaning and adjusting spark plug

The spark plug is an important engine component and is easy to inspect. The condition of the spark plug can indicate something about the condition of the engine. For example, if the center electrode porcelain is very white, this could indicate an intake air leak or carburetion problem in that cylinder. Do not attempt to diagnose any problems yourself. Instead, take the outboard motor to a Yamaha dealer. You should periodically remove and inspect the spark plug because heat and deposits will cause the spark plug to slowly break down and erode.

1. Remove the spark plug caps from the spark plugs.
2. Remove the spark plug. If electrode erosion becomes excessive, or if carbon and other deposits are excessive, you should replace the spark plug with another of the correct type. **WARNING!** When removing or installing a spark plug, be careful not to damage the insulator. A damaged insulator could allow external sparks, which could lead to explosion or fire. [EWM00561]

Standard spark plug:
BR8HS-10

3. Be sure to use the specified spark plug, otherwise the engine may not operate properly. Before fitting the spark plug, measure the electrode gap with a wire thickness gauge; replace it if out of specification.

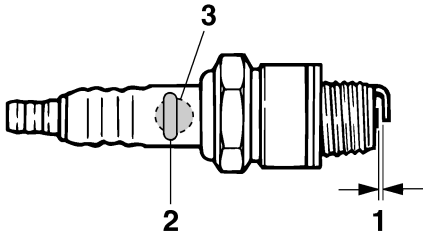

1. Spark plug gap
2. Spark plug part number
3. Spark plug I.D. mark (NGK)

Spark plug gap:
0.9–1.0 mm (0.035–0.039 in)

4. When fitting the plug, wipe off any dirt from the threads, and then screw it in to the correct torque.

Spark plug torque:
25.0 Nm (2.55 kgf-m, 18.4 ft-lb)

TIP:

If a torque-wrench is not available when you are fitting a spark plug, a good estimate of the correct torque is 1/4 to 1/2 a turn past finger-tight. Have the spark plug adjusted to the correct torque as soon as possible with a torque-wrench.

EMU37450

Checking fuel filter

Check the fuel filter periodically. If any water or foreign matter is found in the filter, clean or replace it. For cleaning or replacement of the

fuel filter, consult your Yamaha dealer.

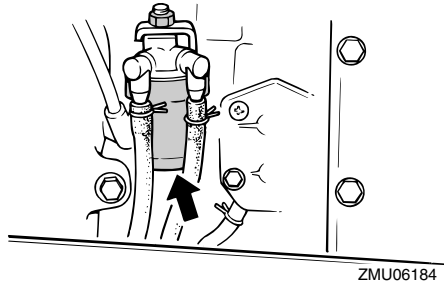

EMU29044

Inspecting idle speed

EWM00451



WARNING

- Do not touch or remove electrical parts when starting or during operation.
- Keep hands, hair, and clothes away from the flywheel and other rotating parts while the engine is running.

ECM00490

NOTICE

This procedure must be performed while the outboard motor is in the water. A flushing attachment or test tank can be used.

If the boat is not equipped with a tachometer for the outboard motor, use a diagnostic tachometer for this procedure. Results may vary depending on whether testing is conducted with the flushing attachment, in a test tank, or with the outboard motor in the water.

1. Start the engine and allow it to warm up fully in neutral until it is running smoothly.
2. Once the engine has warmed up, verify whether the idle speed is set to specification. For idle speed specifications, see page 9. If you have difficulty verifying the idle speed, or the idle speed requires ad-

Maintenance

justment, consult a Yamaha dealer or other qualified mechanic.

EMU29061

Checking water in engine oil tank

A translucent water drain hose is connected from the bottom of the oil tank to the filler neck. If water or foreign matter collects in this hose, consult a Yamaha dealer.

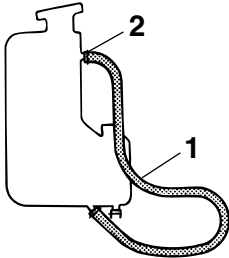

ZMU03881

1. Drain hose
2. Filler neck side

EMU29114

Inspecting wiring and connectors

- Inspect that each connector is engaged securely.
- Inspect that each ground lead is properly secured.

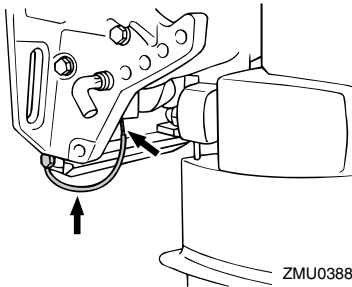

ZMU03882

EMU32112

Checking propeller

EWM01881

WARNING

You could be seriously injured if the en-

gine accidentally starts when you are near the propeller. Before inspecting, removing, or installing the propeller, place the shift control in neutral, turn the main switch to "OFF" (off) and remove the key, and remove the clip from the engine shut-off switch. Turn off the battery cut-off switch if your boat has one.

Do not use your hand to hold the propeller when loosening or tightening the propeller nut. Put a wood block between the anti-cavitation plate and the propeller to prevent the propeller from turning.

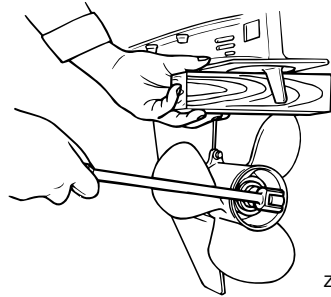

ZMU01897

Checkpoints

- Check each of the propeller blades for erosion from cavitation or ventilation, or other damage.
- Check the propeller shaft for damage.
- Check the splines for wear or damage.
- Check for fish line tangled around the propeller shaft.

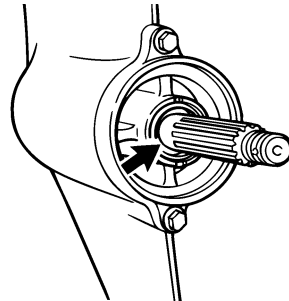

ZMU02274

- Check the propeller shaft oil seal for damage.

EMU30662

Removing propeller

EMU29197

Spine models

1. Straighten the cotter pin and pull it out using a pair of pliers.
2. Remove the propeller nut, washer, and spacer (if equipped). **WARNING! Do not use your hand to hold the propeller when loosening the propeller nut.**

[EWM01890]

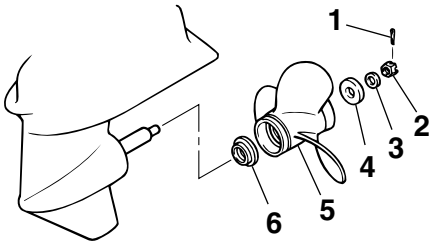

ZMU01898

1. Cotter pin
2. Propeller nut
3. Washer
4. Spacer
5. Propeller
6. Thrust washer

3. Remove the propeller, washer (if equipped), and thrust washer.

EMU30672

Installing propeller

EMU29234

Spine models

ECM00501

NOTICE

Make sure to use a new cotter pin and bend the ends over securely. Otherwise, the propeller could come off during operation and be lost.

1. Apply Yamaha marine grease or a corrosion resistant grease to the propeller shaft.
2. Install the spacer (if equipped), thrust washer, washer (if equipped), and propeller on the propeller shaft. **NOTICE: Make sure to install the thrust washer before installing the propeller. Otherwise, the lower case and propeller boss could be damaged.** [ECM01881]
3. Install the spacer (if equipped) and the washer. Tighten the propeller nut to the specified torque.

Propeller nut tightening torque:
35.0 Nm (3.57 kgf-m, 25.8 ft-lb)

4. Align the propeller nut with the propeller shaft hole. Insert a new cotter pin in the hole and bend the cotter pin ends. **NOTICE: Do not reuse the cotter pin. Otherwise, the propeller can come off during operation.** [ECM01891]

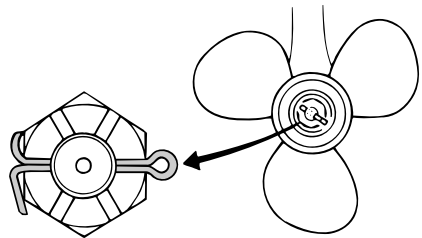

ZMU02063

TIP:

If the propeller nut does not align with the propeller shaft hole after tightening to the specified torque, tighten the nut further to align it with the hole.

Maintenance

EMU29289

Changing gear oil

EWM00800

WARNING

- Be sure the outboard motor is securely fastened to the transom or a stable stand. You could be severely injured if the outboard motor falls on you.
- Never get under the lower unit while it is tilted, even when the tilt support lever or knob is locked. Severe injury could occur if the outboard motor accidentally falls.

1. Tilt the outboard motor so that the gear oil drain screw is at the lowest point possible.
2. Place a suitable container under the gear case.
3. Remove the gear oil drain screw and gasket. **NOTICE: If there is an excessive quantity of metal particles on the magnetic gear oil drain screw, this can indicate lower unit problem. Consult your Yamaha dealer.** [ECM01900]

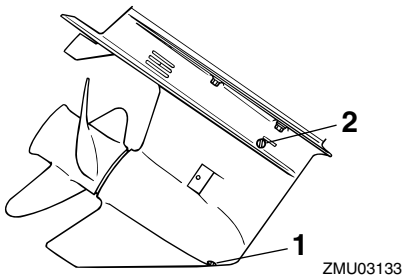

1. Gear oil drain screw
2. Oil level plug

TIP:

- If a magnetic gear oil drain screw is equipped, remove all metal particles from the screw before installing it.

- Always use new gaskets. Do not reuse the removed gaskets.

4. Remove the oil level plug and gasket to allow the oil to drain completely. **NOTICE: Check the used gear oil after it has been drained. If the gear oil is milky or contains water or a large amount of metal particles, the gear case may be damaged. Have a Yamaha dealer check and repair the outboard motor.** [ECM00713]

TIP:

For disposal of used oil, consult your Yamaha dealer.

5. Put the outboard motor in a vertical position. Using a flexible or pressurized filling device, inject the gear oil into the gear oil drain screw hole.

Recommended gear oil:

Hypoid gear oil SAE#90

Gear oil quantity:

0.610 L (0.645 US qt, 0.537 Imp.qt)

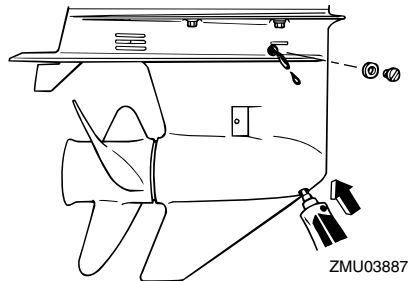

6. Put a new gasket on the oil level plug. When the oil begins to flow out of the oil level plug hole, insert and tighten the oil level plug.

Tightening torque:

9 Nm (0.9 kgf-m, 6.6 ft-lb)

- Put a new gasket on the gear oil drain screw. Insert and tighten the gear oil drain screw.

Tightening torque:

9 Nm (0.9 kgf-m, 6.6 ft-lb)

EMU29302

Cleaning fuel tank

EWM00920



WARNING

Gasoline is highly flammable, and its vapors are flammable and explosive.

- If you have any question about properly doing this procedure, consult your Yamaha dealer.
- Keep away from sparks, cigarettes, flames, or other sources of ignition when cleaning the fuel tank.
- Remove the fuel tank from the boat before cleaning it. Work only outdoors in an area with good ventilation.
- Wipe up any spilled fuel immediately.
- Reassemble the fuel tank carefully. Improper assembly can result in a fuel leak, which could result in a fire or explosion hazard.
- Dispose of old gasoline according to local regulations.

- Empty the fuel tank into an approved container.
- Pour a small amount of suitable solvent into the tank. Install the cap and shake the tank. Drain the solvent completely.
- Remove the screws holding the fuel joint assembly. Pull the assembly out of the tank.

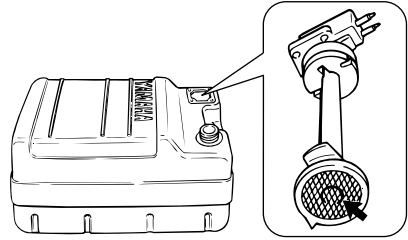

ZMU02324

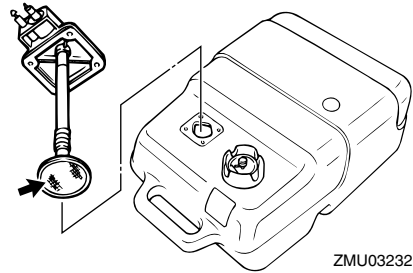

ZMU03232

- Clean the filter (located on the end of the suction pipe) in a suitable cleaning solvent. Allow the filter to dry.
- Replace the gasket with a new one. Reinstall the fuel joint assembly and tighten the screws firmly.

EMU29313

Inspecting and replacing anode(s)

Yamaha outboard motors are protected from corrosion by sacrificial anodes. Inspect the external anodes periodically. Remove scales from the surfaces of the anodes. Consult a Yamaha dealer for replacement of external anodes.

ECM00720

NOTICE

Do not paint anodes, as this would render them ineffective.

Maintenance

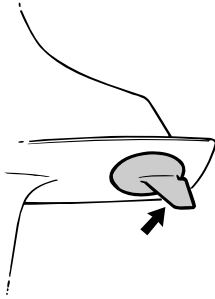

ZMU01901

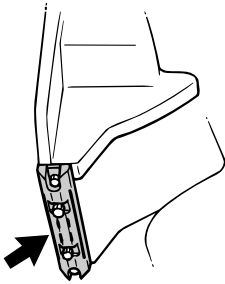

ZMU03888

TIP:

Inspect ground leads attached to external anodes on equipped models. Consult a Yamaha dealer for inspection and replacement of internal anodes attached to the power unit.

EMU29323

Checking battery (for electric start models)

EWM01902

WARNING

Battery electrolyte is poisonous and caustic, and batteries generate explosive hydrogen gas. When working near the battery:

- Wear protective eye gear and rubber gloves.
- Do not smoke or bring any other source of ignition near the battery.

The procedure for checking the battery varies for different batteries. This procedure

contains typical checks that apply to many batteries, but you should always refer to the battery manufacturer's instructions.

ECM01920

NOTICE

A poorly maintained battery will quickly deteriorate.

1. Check the electrolyte level.

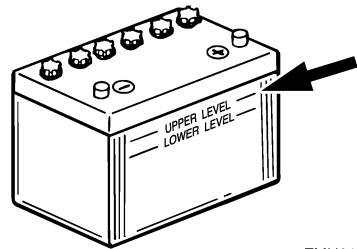

ZMU01810

2. Check the battery's charge. If your boat is equipped with the digital speedometer, the voltmeter and low battery alert functions will help you monitor the battery's charge. If the battery needs charging, consult your Yamaha dealer.
3. Check the battery connections. They should be clean, secure, and covered by an insulating cover. **WARNING! Bad connections can produce shorting or arcing and cause an explosion.**

[EWM01912]

EMU29334

Connecting the battery

EWM00572

WARNING

Mount the battery holder securely in a dry, well-ventilated, vibration-free location in the boat. Install a fully charged battery in the holder.

ECM01124

NOTICE

Do not reverse the battery cables. Other-

wise, the electrical parts could be damaged.

1. Make sure the main switch (on applicable models) is “OFF” (off) before working on the battery.
2. Connect the red battery cable to the POSITIVE (+) terminal first. Then connect the black battery cable to the NEGATIVE (-) terminal.

4. Clean, maintain, and store the battery according to the manufacturer’s instructions.

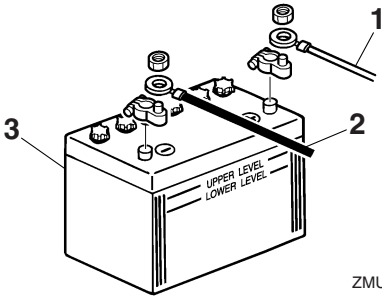

ZMU01811

1. Red cable
2. Black cable
3. Battery

3. The electrical contacts of the battery and cables must be clean and properly connected, or the battery will not start the engine.

EMU29371

Disconnecting the battery

1. Turn off the battery cut-off switch (if equipped) and main switch. **NOTICE: If they are left on, the electrical system can be damaged.** [ECM01930]
2. Disconnect the negative cable(s) from the negative (-) terminal. **NOTICE: Always disconnect all negative (-) cables first to avoid a short circuit and damage to the electrical system.**

[ECM01940]

3. Disconnect the positive cable(s) and remove the battery from the boat.

Trouble Recovery

EMU29427

Troubleshooting

A problem in the fuel, compression, or ignition systems can cause poor starting, loss of power, or other problems. This section describes basic checks and possible remedies, and covers all Yamaha outboard motors. Therefore some items may not apply to your model.

If your outboard motor requires repair, bring it to your Yamaha dealer.

If the engine trouble-alert indicator is flashing, consult your Yamaha dealer.

Starter will not operate.

Q. Is battery capacity weak or low?

A. Check battery condition. Use battery of recommended capacity.

Q. Are battery connections loose or corroded?

A. Tighten battery cables and clean battery terminals.

Q. Is fuse for electric start relay or electric circuit blown?

A. Check for cause of electric overload and repair. Replace fuse with one of correct amperage.

Q. Are starter components faulty?

A. Have serviced by a Yamaha dealer.

Q. Is shift lever in gear?

A. Shift to neutral.

Engine will not start (starter operates).

Q. Is fuel tank empty?

A. Fill tank with clean, fresh fuel.

Q. Is fuel contaminated or stale?

A. Fill tank with clean, fresh fuel.

Q. Is fuel filter clogged?

A. Clean or replace filter.

Q. Is starting procedure incorrect?

A. See page 39.

Q. Has fuel pump malfunctioned?

A. Have serviced by a Yamaha dealer.

Q. Are spark plug(s) fouled or of incorrect type?

A. Inspect spark plug(s). Clean or replace with recommended type.

Q. Are spark plug cap(s) fitted incorrectly?

A. Check and re-fit cap(s).

Q. Is ignition wiring damaged or poorly connected?

A. Check wires for wear or breaks. Tighten all loose connections. Replace worn or broken wires.

Q. Are ignition parts faulty?

A. Have serviced by a Yamaha dealer.

Q. Is engine shut-off cord (lanyard) not attached?

A. Attach cord.

Q. Are engine inner parts damaged?

A. Have serviced by a Yamaha dealer.

Engine idles irregularly or stalls.

Q. Are spark plug(s) fouled or of incorrect type?

A. Inspect spark plug(s). Clean or replace with recommended type.

Trouble Recovery

Q. Is fuel system obstructed?

A. Check for pinched or kinked fuel line or other obstructions in fuel system.

Q. Is fuel contaminated or stale?

A. Fill tank with clean, fresh fuel.

Q. Is fuel filter clogged?

A. Clean or replace filter.

Q. Have ignition parts failed?

A. Have serviced by a Yamaha dealer.

Q. Has alert system activated?

A. Find and correct cause of alert.

Q. Is spark plug gap incorrect?

A. Inspect and adjust as specified.

Q. Is ignition wiring damaged or poorly connected?

A. Check wires for wear or breaks. Tighten all loose connections. Replace worn or broken wires.

Q. Is specified engine oil not being used?

A. Check and replace oil as specified.

Q. Is thermostat faulty or clogged?

A. Have serviced by a Yamaha dealer.

Q. Are carburetor adjustments incorrect?

A. Have serviced by a Yamaha dealer.

Q. Is fuel pump damaged?

A. Have serviced by a Yamaha dealer.

Q. Is air vent screw on fuel tank closed?

A. Open air vent screw.

Q. Is choke knob pulled out?

A. Return to home position.

Q. Is motor angle too high?

A. Return to normal operating position.

Q. Is carburetor clogged?

A. Have serviced by a Yamaha dealer.

Q. Is fuel joint connection incorrect?

A. Connect correctly.

Q. Is throttle valve adjustment incorrect?

A. Have serviced by a Yamaha dealer.

Q. Is battery cable disconnected?

A. Connect securely.

Alert buzzer sounds or indicator lights.

Q. Is cooling system clogged?

A. Check water intake for restriction.

Q. Is engine oil level low?

A. Fill oil tank with specified engine oil.

Q. Is heat range of spark plug incorrect?

A. Inspect spark plug and replace it with recommended type.

Q. Is specified engine oil not being used?

A. Check and replace oil with specified type.

Q. Is engine oil contaminated or deteriorated?

A. Replace oil with fresh, specified type.

Q. Is oil filter clogged?

A. Have serviced by a Yamaha dealer.

Q. Has oil feed/injection pump malfunctioned?

A. Have serviced by a Yamaha dealer.

Trouble Recovery

Q. Is load on boat improperly distributed?

A. Distribute load to place boat on an even plane.

Q. Is water pump or thermostat faulty?

A. Have serviced by a Yamaha dealer.

Q. Is there excess water in fuel filter cup?

A. Drain filter cup.

Engine power loss.

Q. Is propeller damaged?

A. Have propeller repaired or replaced.

Q. Is propeller pitch or diameter incorrect?

A. Install correct propeller to operate outboard at its recommended speed (r/min) range.

Q. Is trim angle incorrect?

A. Adjust trim angle to achieve most efficient operation.

Q. Is motor mounted at incorrect height on transom?

A. Have motor adjusted to proper transom height.

Q. Has alert system activated?

A. Find and correct cause of alert.

Q. Is boat bottom fouled with marine growth?

A. Clean boat bottom.

Q. Are spark plug(s) fouled or of incorrect type?

A. Inspect spark plug(s). Clean or replace with recommended type.

Q. Are weeds or other foreign matter tangled

on gear housing?

A. Remove foreign matter and clean lower unit.

Q. Is fuel system obstructed?

A. Check for pinched or kinked fuel line or other obstructions in fuel system.

Q. Is fuel filter clogged?

A. Clean or replace filter.

Q. Is fuel contaminated or stale?

A. Fill tank with clean, fresh fuel.

Q. Is spark plug gap incorrect?

A. Inspect and adjust as specified.

Q. Is ignition wiring damaged or poorly connected?

A. Check wires for wear or breaks. Tighten all loose connections. Replace worn or broken wires.

Q. Have electrical parts failed?

A. Have serviced by a Yamaha dealer.

Q. Is specified fuel not being used?

A. Replace fuel with specified type.

Q. Is specified engine oil not being used?

A. Check and replace oil with specified type.

Q. Is thermostat faulty or clogged?

A. Have serviced by a Yamaha dealer.

Q. Is air vent screw closed?

A. Open the air vent screw.

Q. Is fuel pump damaged?

A. Have serviced by a Yamaha dealer.

Trouble Recovery

Q. Is fuel joint connection incorrect?

A. Connect correctly.

Q. Is heat range of spark plug incorrect?

A. Inspect spark plug and replace it with recommended type.

Q. Is high pressure fuel pump drive belt broken?

A. Have serviced by a Yamaha dealer.

Q. Is engine not responding properly to shift lever position?

A. Have serviced by a Yamaha dealer.

Engine vibrates excessively.

Q. Is propeller damaged?

A. Have propeller repaired or replaced.

Q. Is propeller shaft damaged?

A. Have serviced by a Yamaha dealer.

Q. Are weeds or other foreign matter tangled on propeller?

A. Remove and clean propeller.

Q. Is motor mounting bolt loose?

A. Tighten bolt.

Q. Is steering pivot loose or damaged?

A. Tighten or have serviced by a Yamaha dealer.

EMU29433

Temporary action in emergency

EMU29441

Impact damage

EWM00870



The outboard motor can be seriously damaged by a collision while operating or

trailing. Damage could make the outboard motor unsafe to operate.

If the outboard motor hits an object in the water, follow the procedure below.



1. Stop the engine immediately.
2. Check the control system and all components for damage. Also, check the boat for damage.
3. Whether damage is found or not, return to the nearest harbor slowly and carefully.
4. Have a Yamaha dealer check the outboard motor before operating it again.

EMU29463

Replacing fuse

If the fuse has blown on an electric start model, open the fuse holder and replace the fuse with a new one of the proper amperage.

EWM00631



Substituting an incorrect fuse or a piece of wire could allow excessive current flow. This could cause electric system damage and a fire hazard.

Trouble Recovery

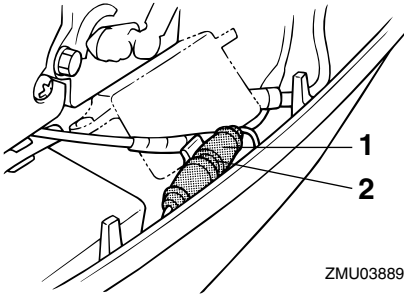

ZMU03889

1. Fuse holder
2. Fuse (20 A)

Consult your Yamaha dealer if the new fuse immediately blows again.

EMU29512

Power trim and tilt will not operate

If the engine cannot be tilted up or down with the power trim and tilt because of a discharged battery or a failure with the power trim and tilt unit, the engine can be tilted manually.

1. Loosen the manual valve screw by turning it clockwise until it stops.

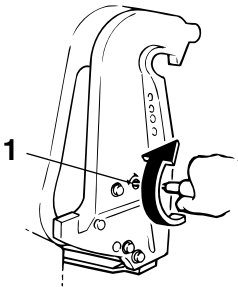

ZMU03890

1. Manual valve screw
2. Put the engine in the desired position, then tighten the manual valve screw by turning it counterclockwise.

EMU29533

Starter will not operate

If the starter mechanism does not operate

(the engine cannot be cranked with the starter), the engine can be started with an emergency starter rope.

EWMM01022

WARNING

- Use this procedure only in an emergency to return to the nearest port for repairs.
- When the emergency starter rope is used to start the engine, the start-in-gear protection device does not operate. Make sure the remote control lever is in neutral. Otherwise the boat could unexpectedly start to move, which could result in an accident.
- Attach the engine shut-off cord to a secure place on your clothing, or your arm or leg while operating the boat.
- Do not attach the cord to clothing that could tear loose. Do not route the cord where it could become entangled, preventing it from functioning.
- Avoid accidentally pulling the cord during normal operation. Loss of engine power means the loss of most steering control. Also, without engine power, the boat could slow rapidly. This could cause people and objects in the boat to be thrown forward.
- Make sure no one is standing behind you when pulling the starter rope. It could whip behind you and injure someone.
- An unguarded, rotating flywheel is very dangerous. Keep loose clothing and other objects away when starting the engine. Use the emergency starter rope only as instructed. Do not touch the flywheel or other moving parts when the engine is running. Do not install the starter mechanism or top cowling after

the engine is running.

- Do not touch the ignition coil, spark plug wire, spark plug cap, or other electrical components when starting or operating the motor. You could get an electrical shock.

EMU29574

Emergency starting engine

1. Remove the top cowling.
2. Disconnect the start-in-gear protection cable from the starter, if equipped.
3. Remove the starter/flywheel cover after removing the bolt(s).

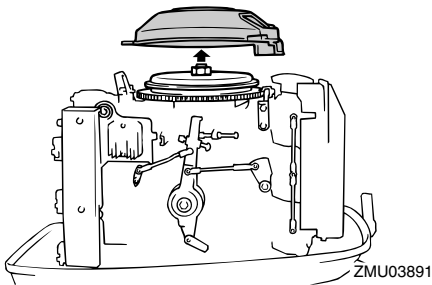

4. Prepare the engine for starting. For further information, see page 39. Be sure the engine is in neutral and that the clip is attached to the engine shut-off switch. The main switch must be "ON" (on), if equipped.

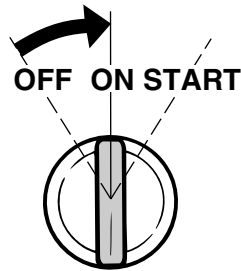
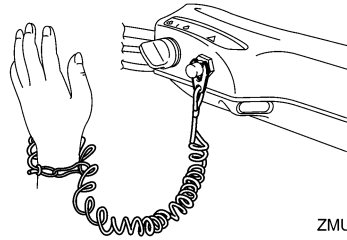
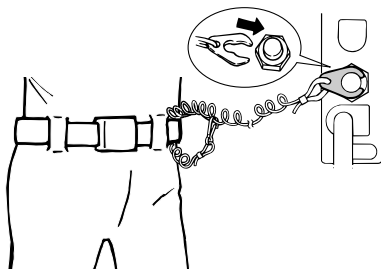

5. Insert the knotted end of the emergency starter rope into the notch in the flywheel rotor and wind the rope several turns around the flywheel clockwise.
6. Pull the rope slowly until resistance is felt.
7. Give a strong pull straight out to crank and start the engine. Repeat if necessary.

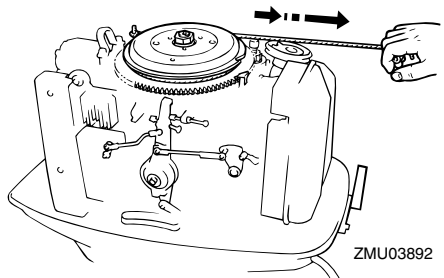

TIP:

When the engine does not start with this pro-

Trouble Recovery

cedure, see page 74.

EMU29671

Engine fails to operate

EMU29691

Ignition system malfunction

If the battery voltage is low or in the unlikely event of an ignition system malfunction, the engine speed may become erratic or the engine may stop. In such a situation, follow the procedure below.

1. Remove the CDI unit cover or electrical cover, if equipped.
2. Disconnect the yellow cord (emergency circuit) of the CDI unit to return to port.

EWM00350

WARNING

When the yellow cord is disconnected, the idle and low speeds are slightly higher than normal. Use care when starting off or stopping.

ECM00380

NOTICE

Follow this procedure only in an emergency and just long enough to return to port for repairs.

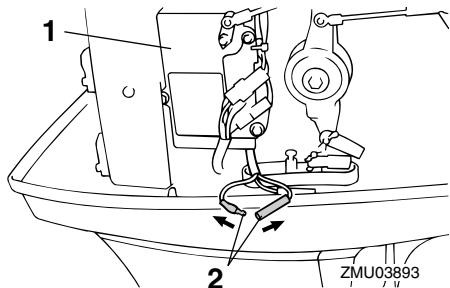

1. CDI unit
2. Yellow cord

EMU29706

Cold engine fails to start

If the engine fails to start when it is cold, use

the following procedure.

EWM00410

WARNING

When starting or operating the engine, do not touch the ignition coil, spark plug wire, spark plug cap, or other electrical parts carrying high voltage. Keep loose clothing and other objects away from the engine when starting it. Do not touch the flywheel or other moving parts when the engine is running.

1. Adjust the trim angle so that the drive shaft is at right angles to the water surface or is trimmed in.
2. On models equipped with an emergency starter valve, open it. The valve is located behind the silencer cover on the front of the engine.

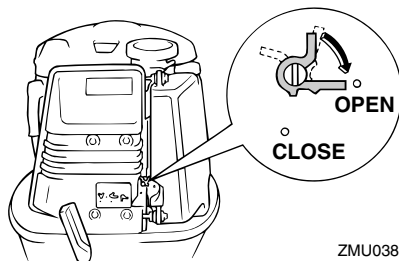

3. Squeeze the primer pump two or three times to feed fuel.



Trouble Recovery

- Open the throttle slightly without shifting using the throttle grip, neutral throttle lever or free accelerator. It is necessary to change the throttle opening slightly depending on the engine temperature. After the engine starts, return the throttle to its original position.

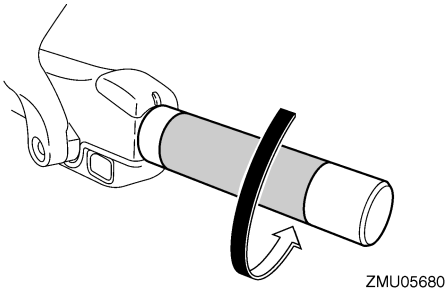
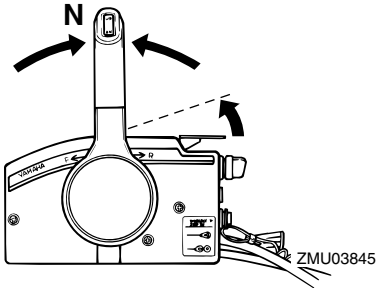

- Turn the main switch to "ON" (on).

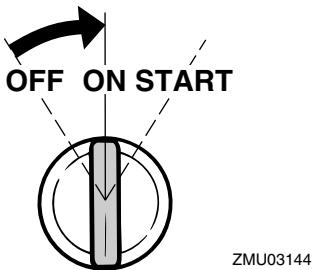

- Turn the main switch to "START" (start). **NOTICE:** Never turn the main switch to "START" (start) while the engine is

running. Do not keep the starter motor turning for more than 5 seconds. If the starter motor is turned continuously for more than 5 seconds, the battery will be quickly discharged, thus making it impossible to start the engine. The starter can also be damaged. If the engine will not start after 5 seconds of cranking, return the main switch to "ON" (on), wait 10 seconds, then crank the engine again.

[ECM00192]

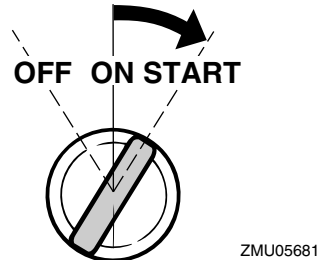

- After the engine starts, close the emergency starter valve (if used), then return the throttle to its original position.

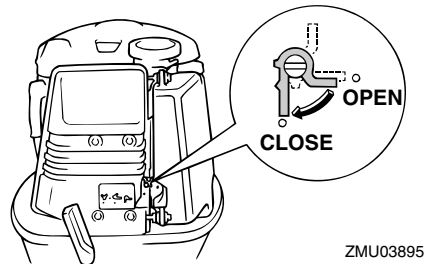

TIP:

When the starter mechanism malfunctions, see page 72.

EMU33501

Treatment of submerged motor

If the outboard motor is submerged, immedi-

Trouble Recovery

ately take it to a Yamaha dealer. Otherwise some corrosion may begin almost immediately. **NOTICE: Do not attempt to run the outboard motor until it has been completely inspected.** [ECM00401]



YAMAHA

YAMAHA MOTOR CO., LTD.

Printed in Japan

March 2010-0.1 × 1 

Printed on recycled paper