

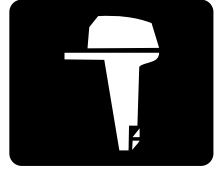

YAMAHA



9.9F
15F

OWNER'S MANUAL

▲ Read this manual carefully before operating this outboard motor.

63V-28199-7C-E0

Read this manual carefully before operating this outboard motor. Keep this manual onboard in a waterproof bag when boating. This manual should stay with the outboard motor if it is sold.

Important manual information

EMU25107

To the owner

Thank you for selecting a Yamaha outboard motor. This Owner's Manual contains information needed for proper operation, maintenance and care. A thorough understanding of these simple instructions will help you obtain maximum enjoyment from your new Yamaha. If you have any question about the operation or maintenance of your outboard motor, please consult a Yamaha dealer.

In this Owner's Manual particularly important information is distinguished in the following ways.



: This is the safety alert symbol. It is used to alert you to potential personal injury hazards. Obey all safety messages that follow this symbol to avoid possible injury or death.

EWV00781



WARNING

A WARNING indicates a hazardous situation which, if not avoided, could result in death or serious injury.

ECM00701

NOTICE

A NOTICE indicates special precautions that must be taken to avoid damage to the outboard motor or other property.

TIP:

A TIP provides key information to make procedures easier or clearer.

Yamaha continually seeks advancements in product design and quality. Therefore, while this manual contains the most current product information available at the time of printing, there may be minor discrepancies between

your machine and this manual. If there is any question concerning this manual, please consult your Yamaha dealer.

To ensure long product life, Yamaha recommends that you use the product and perform the specified periodic inspections and maintenance by correctly following the instructions in the owner's manual. Any damage resulting from neglect of these instructions is not covered by warranty.

Some countries have laws or regulations restricting users from taking the product out of the country where it was purchased, and it may be impossible to register the product in the destination country. Additionally, the warranty may not apply in certain regions. When planning to take the product to another country, consult the dealer where the product was purchased for further information.

If the product was purchased used, please consult your closest dealer for customer re-registration, and to be eligible for the specified services.

TIP:

The 9.9FMH, 15FMH and the standard accessories are used as a base for the explanations and illustrations in this manual. Therefore some items may not apply to every model.

EMU25121

**9.9F, 15F
OWNER'S MANUAL
©2010 by Yamaha Motor Co., Ltd.
1st Edition, February 2010
All rights reserved.
Any reprinting or unauthorized use
without the written permission of
Yamaha Motor Co., Ltd.
is expressly prohibited.
Printed in Japan**

Table of contents

Safety information	1	Muddy or acidic water	10
Outboard motor safety	1	Anti-fouling paint	10
Propeller	1	Motor disposal requirements.....	11
Rotating parts	1	Emergency equipment.....	11
Hot parts.....	1	Components	12
Electric shock	1	Components diagram.....	12
Engine shut-off cord (lanyard)	1	Fuel tank.....	12
Gasoline	1	Fuel joint.....	13
Gasoline exposure and spills	1	Fuel gauge	13
Carbon monoxide.....	1	Fuel tank cap.....	13
Modifications	2	Air vent screw.....	13
Boating safety	2	Tiller handle.....	13
Alcohol and drugs.....	2	Gear shift lever	13
Personal flotation devices	2	Throttle grip	13
People in the water.....	2	Throttle indicator.....	14
Passengers	2	Throttle friction adjuster.....	14
Overloading	2	Engine shut-off cord (lanyard) and	
Avoid collisions.....	2	clip.....	14
Weather.....	3	Engine stop button	15
Passenger training	3	Choke knob	15
Boating safety publications.....	3	Manual starter handle.....	15
Laws and regulations	3	Steering friction adjuster.....	15
General information	4	Trim rod (tilt pin)	16
Identification numbers record	4	Tilt lock mechanism.....	16
Outboard motor serial number	4	Tilt support bar	16
EC Declaration of Conformity		Cowling lock lever(s) (turn type).....	17
(DoC).....	4	2-pin connector.....	17
CE Marking	4	Battery charging information	17
Read manuals and labels.....	5	Installation	18
Warning labels.....	5	Installation.....	18
Specifications and requirements	8	Mounting the outboard motor	18
Specifications	8	Clamping the outboard motor.....	19
Installation requirements	9	Operation	21
Boat horsepower rating	9	First-time operation	21
Mounting motor	9	Breaking in engine.....	21
Propeller selection.....	9	Getting to know your boat	21
Start-in-gear protection	10	Checks before starting engine	21
Engine oil requirements	10	Fuel level	21
Fuel requirements	10	Remove the top cowling	22
Gasoline	10	Fuel system	22
		Controls	22
		Engine shut-off cord (lanyard)	22
		Oil	23
		Engine	23

Table of contents

Install top cowling.....	23	Severe operating conditions.....	39
Filling fuel and engine oil.....	23	Maintenance chart 1.....	40
Filling fuel for portable tank.....	23	Maintenance chart 2.....	41
Gasoline and oil mixing (100:1).....	24	Greasing.....	42
Operating engine.....	25	Cleaning and adjusting spark plug ...	43
Sending fuel (portable tank).....	26	Checking fuel filter.....	43
Starting engine.....	26	Inspecting idle speed.....	43
Checks after starting engine.....	28	Inspecting wiring and connectors.....	44
Cooling water.....	28	Checking propeller.....	44
Warming up engine.....	28	Removing propeller.....	45
Choke start models.....	28	Installing propeller.....	45
Checks after engine warm up.....	28	Changing gear oil.....	46
Shifting.....	28	Cleaning fuel tank.....	47
Stop switches.....	28	Inspecting and replacing anode(s) ...	48
Shifting.....	29	Trouble Recovery.....	49
Stopping boat.....	30	Troubleshooting.....	49
Stopping engine.....	30	Temporary action in emergency ...	52
Procedure.....	30	Impact damage.....	52
Trimming outboard motor.....	30	Starter will not operate.....	52
Adjusting trim angle for manual tilt		Emergency starting engine.....	53
models.....	31	Treatment of submerged motor	54
Adjusting boat trim.....	31		
Tilting up and down.....	32		
Procedure for tilting up (manual tilt			
models).....	33		
Procedure for tilting down (manual			
tilt models).....	33		
Shallow water.....	34		
Cruising in shallow water (manual			
tilt models).....	34		
Cruising in other conditions.....	35		
Maintenance.....	36		
Transporting and storing outboard			
motor.....	36		
Clamp screw mounting models.....	36		
Storing outboard motor.....	37		
Procedure.....	37		
Lubrication.....	38		
Cleaning the outboard motor.....	38		
Checking painted surface of			
outboard motor.....	38		
Periodic maintenance.....	38		
Replacement parts.....	39		

Safety information

EMU33622

Outboard motor safety

Observe these precautions at all times.

EMU36501

Propeller

People can be injured or killed if they come in contact with the propeller. The propeller can keep moving even when the motor is in neutral, and sharp edges of the propeller can cut even when stationary.

- Stop the engine when a person is in the water near you.
- Keep people out of reach of the propeller, even when the engine is off.

EMU33630

Rotating parts

Hands, feet, hair, jewelry, clothing, PFD straps, etc. can become entangled with internal rotating parts of the engine, resulting in serious injury or death.

Keep the top cowling in place whenever possible. Do not remove or replace the cowling with the engine running.

Only operate the engine with the cowling removed according to the specific instructions in the manual. Keep hands, feet, hair, jewelry, clothing, PFD straps, etc. away from any exposed moving parts.

EMU33640

Hot parts

During and after operation, engine parts are hot enough to cause burns. Avoid touching any parts under the top cowling until the engine has cooled.

EMU33650

Electric shock

Do not touch any electrical parts while starting or operating the engine. They can cause shock or electrocution.

EMU33671

Engine shut-off cord (lanyard)

Attach the engine shut-off cord so that the engine stops if the operator falls overboard or leaves the helm. This prevents the boat from

running away under power and leaving people stranded, or running over people or objects.

Always attach the engine shut-off cord to a secure place on your clothing or your arm or leg while operating. Do not remove it to leave the helm while the boat is moving. Do not attach the cord to clothing that could tear loose, or route the cord where it could become entangled, preventing it from functioning.

Do not route the cord where it is likely to be accidentally pulled out. If the cord is pulled during operation, the engine will shut off and you will lose most steering control. The boat could slow rapidly, throwing people and objects forward.

EMU33810

Gasoline

Gasoline and its vapors are highly flammable and explosive. Always, refuel according to the procedure on page 25 to reduce the risk of fire and explosion.

EMU33820

Gasoline exposure and spills

Take care not to spill gasoline. If gasoline spills, wipe it up immediately with dry rags. Dispose of rags properly.

If any gasoline spills onto your skin, immediately wash with soap and water. Change clothing if gasoline spills on it.

If you swallow gasoline, inhale a lot of gasoline vapor, or get gasoline in your eyes, get immediate medical attention. Never siphon fuel by mouth.

EMU33900

Carbon monoxide

This product emits exhaust gases which contain carbon monoxide, a colorless, odorless gas which may cause brain damage or death when inhaled. Symptoms include nausea, dizziness, and drowsiness. Keep cockpit and cabin areas well ventilated. Avoid blocking exhaust outlets.

EMU33780

Modifications

Do not attempt to modify this outboard motor. Modifications to your outboard motor may reduce safety and reliability, and render the outboard unsafe or illegal to use.

EMU33740

Boating safety

This section includes a few of the many important safety precautions that you should follow when boating.

EMU33710

Alcohol and drugs

Never operate after drinking alcohol or taking drugs. Intoxication is one of the most common factors contributing to boating fatalities.

EMU33720

Personal flotation devices

Have an approved personal flotation device (PFD) on board for every occupant. Yamaha recommends that you must wear a PFD whenever boating. At a minimum, children and non-swimmers should always wear PFDs, and everyone should wear PFDs when there are potentially hazardous boating conditions.

EMU33731

People in the water

Always watch carefully for people in the water, such as swimmers, skiers, or divers, whenever the engine is running. When someone is in the water near the boat, shift into neutral and stop the engine.

Stay away from swimming areas. Swimmers can be hard to see.

The propeller can keep moving even when the motor is in neutral. Stop the engine when a person is in the water near you.

EMU33751

Passengers

Consult your boat manufacturer's instructions for details about appropriate passenger locations in your boat and be sure all passengers are positioned properly before accelerating

and when operating above an idle speed. Standing or sitting in non-designated locations may result in being thrown either overboard or within the boat due to waves, wakes, or sudden changes in speed or direction. Even when people are positioned properly, alert your passengers if you must make any unusual maneuver. Always avoid jumping waves or wakes.

EMU33760

Overloading

Do not overload the boat. Consult the boat capacity plate or boat manufacturer for maximum weight and number of passengers. Be sure that weight is properly distributed according to the boat manufacturer's instructions. Overloading or incorrect weight distribution can compromise the boat's handling and lead to an accident, capsizing or swamping.

EMU33772

Avoid collisions

Scan constantly for people, objects, and other boats. Be alert for conditions that limit your visibility or block your vision of others.

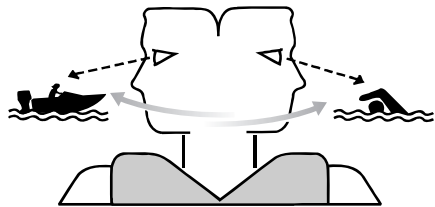

ZMU06025

Operate defensively at safe speeds and keep a safe distance away from people, objects, and other boats.

- Do not follow directly behind other boats or waterskiers.

Safety information

- Avoid sharp turns or other maneuvers that make it hard for others to avoid you or understand where you are going.
- Avoid areas with submerged objects or shallow water.
- Ride within your limits and avoid aggressive maneuvers to reduce the risk of loss of control, ejection, and collision.
- Take early action to avoid collisions. Remember, boats do not have brakes, and stopping the engine or reducing throttle can reduce the ability to steer. If you are not sure that you can stop in time before hitting an obstacle, apply throttle and turn in another direction.

EMU33790

Weather

Stay informed about the weather. Check weather forecasts before boating. Avoid boating in hazardous weather.

EMU33880

Passenger training

Make sure at least one other passenger is trained to operate the boat in the event of an emergency.

EMU33890

Boating safety publications

Be informed about boating safety. Additional publications and information can be obtained from many boating organizations.

EMU33600

Laws and regulations

Know the marine laws and regulations where you will be boating- and obey them. Several sets of rules prevail according to geographic location, but all are basically the same as the International Rules of the Road.

EMU25171

Identification numbers record

EMU25183

Outboard motor serial number

The outboard motor serial number is stamped on the label attached to the port side of the clamp bracket.

Record your outboard motor serial number in the spaces provided to assist you in ordering spare parts from your Yamaha dealer or for reference in case your outboard motor is stolen.

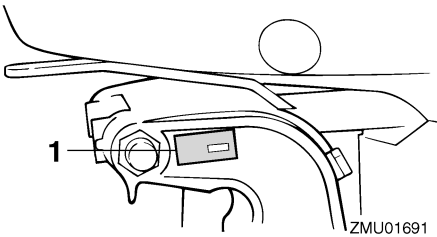

1. Outboard motor serial number location

- Name of Engine Manufacture
- Model name
- Product code of model (Approved model code)
- Code of conformed directives

EMU25203

CE Marking

Outboard motors affixed with this “CE” marking conform with the directives of; 98/37/EC, 94/25/EC - 2003/44/EC and 2004/108/EC.

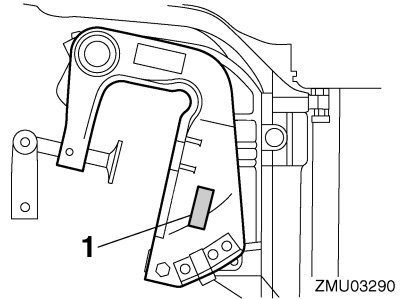

1. CE marking location

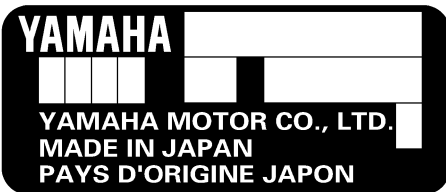

ZMU01692



ZMU06040

EMU37290

EC Declaration of Conformity (DoC)

This outboard motor conforms to certain portions of the European Parliament directive relating to machinery.

Each conformed outboard motor accompanied with EC DoC. EC DoC contains the following information;

General information

EMU33522

Read manuals and labels

Before operating or working on this outboard motor:

- Read this manual.
- Read any manuals supplied with the boat.
- Read all labels on the outboard motor and the boat.

If you need any additional information, contact your Yamaha dealer.

EMU33832

Warning labels

If these labels are damaged or missing, contact your Yamaha dealer for replacements.

9.9F, 15F

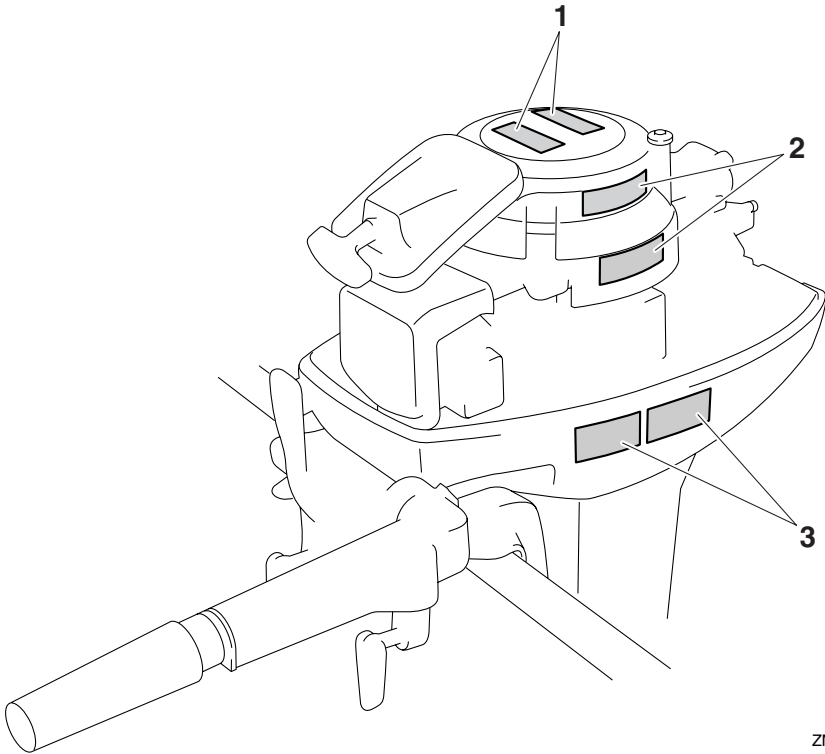

ZMU06038

1



2



3

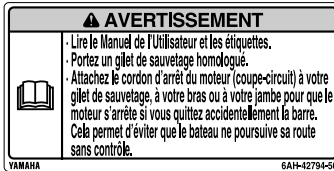
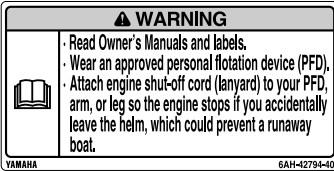

ZMU05740

EMU33912

Contents of labels

The above warning labels mean as follows.

1

EWM01691



Emergency starting does not have start-in-gear protection. Ensure shift control is in neutral before starting engine.

2

EWM01681



- Keep hands, hair, and clothing away from rotating parts while the engine is running.
- Do not touch or remove electrical parts when starting or during operation.

3

EWM01671



- Read Owner's Manuals and labels.
- Wear an approved personal flotation device (PFD).
- Attach engine shut-off cord (lanyard) to your PFD, arm, or leg so the engine stops if you accidentally leave the helm, which could prevent a runaway boat.

General information

EMU33843

Symbols

The following symbols mean as follows.

Notice/Warning



ZMU05696

Read Owner's Manual



ZMU05664

Hazard caused by continuous rotation

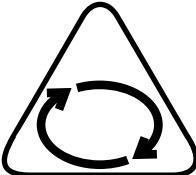

ZMU05665

Electrical hazard

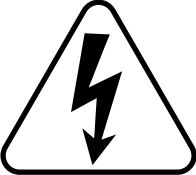

ZMU05666

Remote control lever/gear shift lever operating direction, dual direction



ZMU05667

Engine start/ Engine cranking

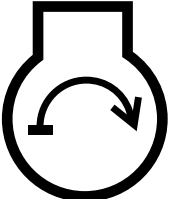

ZMU05668

Specifications and requirements

EMU31480

Specifications

TIP:

“(AL)” stated in the specification data below represents the numerical value for the aluminum propeller installed.

Likewise, “(SUS)” represents the value for stainless steel propeller installed and “(PL)” for plastic propeller installed.

EMU2821J

Dimension:

Overall length:

873 mm (34.4 in)

Overall width:

332 mm (13.1 in)

Overall height S:

1040 mm (40.9 in)

Overall height L:

1167 mm (45.9 in)

Transom height S:

440 mm (17.3 in)

Transom height L:

567 mm (22.3 in)

Weight (AL) S:

36.0 kg (79 lb)

Weight (AL) L:

37.5 kg (83 lb)

Performance:

Full throttle operating range:

4500–5500 r/min

Maximum output:

15FMH 11.0 kW @ 5000 r/min (15

HP @ 5000 r/min)

9.9FMH 7.3 kW @ 5000 r/min (9.9

HP @ 5000 r/min)

Idle speed (in neutral):

750 ±50 r/min

Engine:

Type:

2-stroke L

Displacement:

246.0 cm³

Bore × stroke:

56.0 × 50.0 mm (2.20 × 1.97 in)

Ignition system:

CDI

Spark plug (NGK):

BR7HS-10

Spark plug gap:

0.9–1.0 mm (0.035–0.039 in)

Control system:

Tiller handle

Starting system:

Manual starter

Starting carburetion system:

Choke valve

Alternator output:

80 W

Drive unit:

Gear positions:

Forward-neutral-reverse

Gear ratio:

2.08 (27/13)

Trim and tilt system:

Manual tilt

Propeller mark:

J

Fuel and oil:

Recommended fuel:

Regular unleaded gasoline

Min. research octane:

90

Fuel tank capacity:

25.0 L (6.61 US gal, 5.50 Imp.gal)

Recommended engine oil:

YAMALUBE 2-stroke outboard motor oil

Recommended engine oil:

TC-W3

Fuel:oil ratio:

Regular gasoline:

100 :1

Specifications and requirements

Lubrication:

Pre-mixed fuel and oil

Recommended gear oil:

Hypoid gear oil SAE#90

Gear oil quantity:

0.250 L (0.264 US qt, 0.220 Imp.qt)

Tightening torque for engine:

Spark plug:

25.0 Nm (2.55 kgf-m, 18.4 ft-lb)

Propeller nut:

17.0 Nm (1.73 kgf-m, 12.5 ft-lb)

Noise and vibration level:

Operator sound pressure level (ICOMIA 39/94 and 40/94):

85.2 dB(A)

Sound power level (ICOMIA 39/94 and 40/94):

92.1 dB(A)

Vibration on tiller handle (ICOMIA 38/94):

Vibration on tiller handle is under 2.5 m/s²

EMU33554

Installation requirements

EMU33564

Boat horsepower rating

EWM01560



Overpowering a boat can cause severe instability.

Before installing the outboard motor(s), confirm that the total horsepower of your outboard motor(s) does not exceed the boat's maximum horsepower rating. See the boat's capacity plate or contact the manufacturer.

EMU33571

Mounting motor

EWM01570



- **Improper mounting of the outboard motor could result in hazardous conditions such as poor handling, loss of control, or fire hazards.**

- **Because the motor is very heavy, special equipment and training is required to mount it safely.**
-

Your dealer or other person experienced in proper rigging should mount the motor using correct equipment and complete rigging instructions. For further information, see page 18.

EMU34194

Propeller selection

Next to selecting an outboard motor, selecting the right propeller is one of the most important purchasing decisions a boater can make. The type, size, and design of your propeller have a direct impact on acceleration, top speed, fuel economy, and even engine life. Yamaha designs and manufactures propellers for every Yamaha outboard motor and every application.

Your outboard motor came with a Yamaha propeller selected to perform well over a range of applications, but there may be uses where a different propeller would be more appropriate.

Your Yamaha dealer can help you select the right propeller for your boating needs. Select a propeller that will allow the engine to reach the middle or upper half of the operating range at full throttle with the maximum boat-load. Generally, select a larger pitch propeller for a smaller operating load and a smaller pitch propeller for a heavier load. If you carry loads that vary widely, select the propeller that lets the engine run in the proper range for your maximum load but remember that you may need to reduce your throttle setting to stay within the recommended engine speed range when carrying lighter loads.

To check the propeller, see page 44.

Specifications and requirements

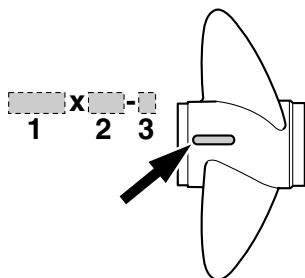

ZMU04606

1. Propeller diameter in inches
2. Propeller pitch in inches
3. Type of propeller (propeller mark)

EMU25770

Start-in-gear protection

Yamaha outboard motors or Yamaha-approved remote control units are equipped with start-in-gear protection device(s). This feature permits the engine to be started only when it is in neutral. Always select neutral before starting the engine.

EMU25651

Engine oil requirements

Recommended engine oil:
YAMALUBE 2-stroke outboard motor oil

If the recommended engine oil is not available, another 2-stroke engine oil with an NMMA-certified TC-W3 rating may be used.

EMU36360

Fuel requirements

EMU36802

Gasoline

Use a good quality gasoline that meets the minimum octane rating. If knocking or pinging occurs, use a different brand of gasoline or premium unleaded fuel.

Recommended gasoline:
Regular unleaded gasoline with a minimum octane rating of 90 (Research Octane Number).

ECM01981

NOTICE

- Do not use leaded gasoline. Leaded gasoline can seriously damage the engine.
- Avoid getting water and contaminants in the fuel tank. Contaminated fuel can cause poor performance or engine damage. Use only fresh gasoline that has been stored in clean containers.

EMU36880

Muddy or acidic water

Yamaha strongly recommends that you have your dealer install the optional chromium-plated water pump kit if you use the outboard motor in muddy or acidic water conditions. However, depending on the model it might not be required.

EMU36330

Anti-fouling paint

A clean hull improves boat performance. The boat bottom should be kept as clean of marine growth as possible. If necessary, the boat bottom can be coated with an anti-fouling paint approved for your area to inhibit marine growth.

Do not use anti-fouling paint which includes copper or graphite. These paints can cause more rapid engine corrosion.

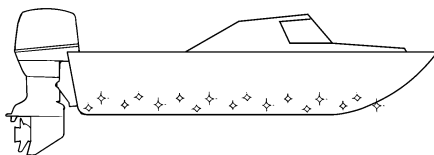

ZMU05176

Specifications and requirements

EMU36341

Motor disposal requirements

Never illegally discard (dump) the motor. Yamaha recommends consulting the dealer about discarding the motor.

EMU36352

Emergency equipment

Keep the following items onboard in case there is trouble with the outboard motor.

- A tool kit with assorted screwdrivers, pliers, wrenches (including metric sizes), and electrical tape.
- Waterproof flashlight with extra batteries.
- An extra engine shut-off cord (lanyard) with clip.
- Spare parts, such as an extra set of spark plugs.

Consult your Yamaha dealer for details.

EMU2579T

Components diagram

TIP:

* May not be exactly as shown; also may not be included as standard equipment on all models (order from dealer).

9.9F, 15F

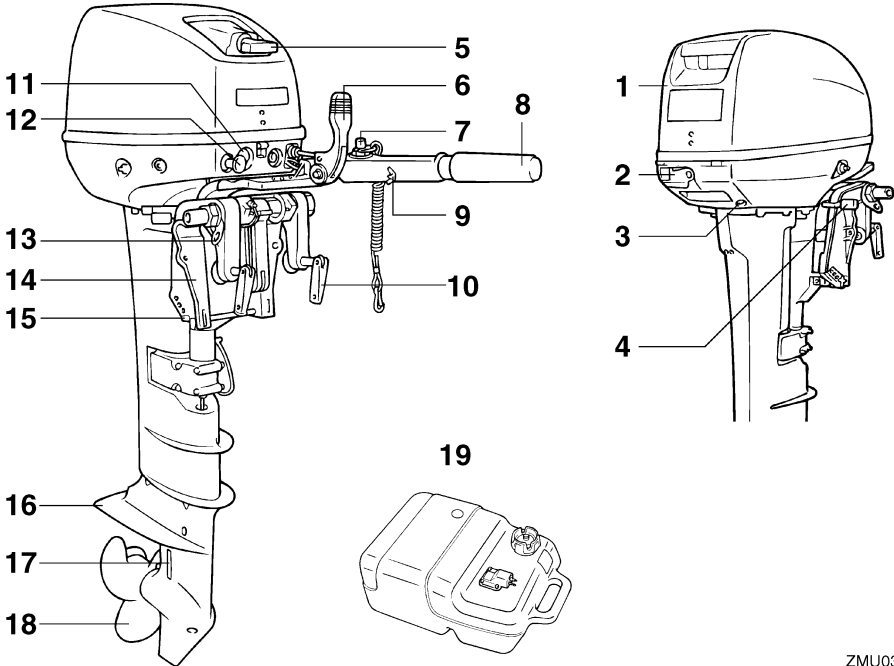

1. Top cowling
2. Cowling lock lever
3. Cooling water pilot hole
4. Tilt lock lever
5. Manual starter handle
6. Gear shift lever
7. Engine stop button/Engine shut-off switch
8. Tiller handle
9. Throttle friction adjuster
10. Clamp screw
11. 2-pin connector*
12. Choke knob
13. Restraint cable attachment
14. Clamp bracket
15. Trim rod

16. Anti-cavitation plate
17. Cooling water inlet
18. Propeller
19. Fuel tank

EMU25802

Fuel tank

If your model was equipped with a portable fuel tank, its function is as follows.

EWV00020

WARNING

The fuel tank supplied with this engine is its dedicated fuel reservoir and must not be used as a fuel storage container. Com-

ZMU03293

Components

mercial users should conform to relevant licensing or approval authority regulations.

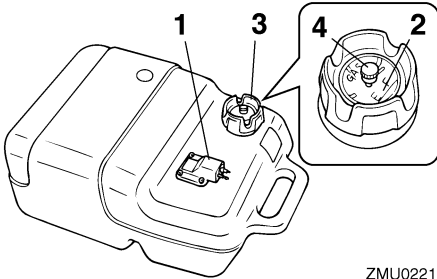

ZMU02219

1. Fuel joint
2. Fuel gauge
3. Fuel tank cap
4. Air vent screw

EMU25830

Fuel joint

This joint is used to connect the fuel line.

EMU25841

Fuel gauge

This gauge is located on either the fuel tank cap or on the fuel joint base. It shows the approximate amount of fuel remaining in the tank.

EMU25850

Fuel tank cap

This cap seals the fuel tank. When removed, the tank can be filled with fuel. To remove the cap, turn it counterclockwise.

EMU25860

Air vent screw

This screw is on the fuel tank cap. To loosen the screw, turn it counterclockwise.

EMU25912

Tiller handle

To change direction, move the tiller handle to the left or right as necessary.

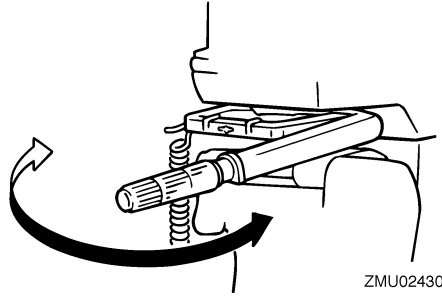

ZMU02430

EMU25923

Gear shift lever

Move the gear shift lever forward to engage the forward gear or rearward to engage the reverse gear.

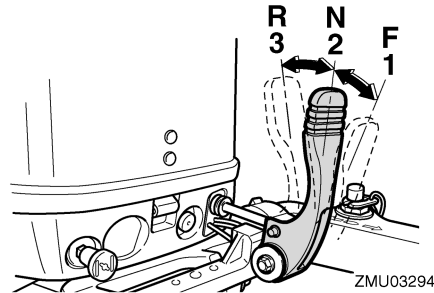

ZMU03294

1. Forward "F"
2. Neutral "N"
3. Reverse "R"

EMU25941

Throttle grip

The throttle grip is on the tiller handle. Turn the grip counterclockwise to increase speed and clockwise to decrease speed.

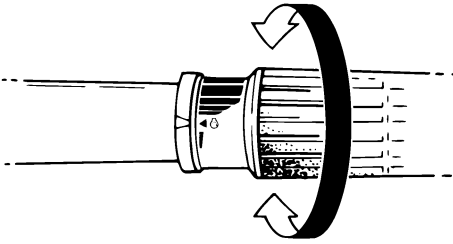

ZMU02432

EMU25961

Throttle indicator

The fuel consumption curve on the throttle indicator shows the relative amount of fuel consumed for each throttle position. Choose the setting that offers the best performance and fuel economy for the desired operation.

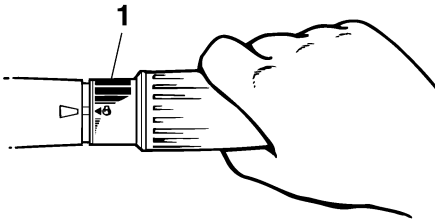

ZMU02433

1. Throttle indicator

EMU25976

Throttle friction adjuster

A friction device provides adjustable resistance to movement of the throttle grip or the remote control lever, and can be set according to operator preference.

To increase resistance, turn the adjuster clockwise. To decrease resistance, turn the adjuster counterclockwise. **WARNING! Do not overtighten the friction adjuster. If there is too much resistance, it could be difficult to move the remote control lever or throttle grip, which could result in an accident.** [EWM00032]

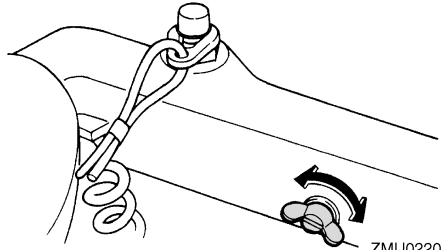

ZMU02208

When constant speed is desired, tighten the adjuster to maintain the desired throttle setting.

EMU25994

Engine shut-off cord (lanyard) and clip

The clip must be attached to the engine shut-off switch for the engine to run. The cord should be attached to a secure place on the operator's clothing, or arm or leg. Should the operator fall overboard or leave the helm, the cord will pull out the clip, stopping ignition to the engine. This will prevent the boat from running away under power. **WARNING! Attach the engine shut-off cord to a secure place on your clothing, or your arm or leg while operating. Do not attach the cord to clothing that could tear loose. Do not route the cord where it could become entangled, preventing it from functioning. Avoid accidentally pulling the cord during normal operation. Loss of engine power means the loss of most steering control. Also, without engine power, the boat could slow rapidly. This could cause people and objects in the boat to be thrown forward.**

[EWM00122]

Components

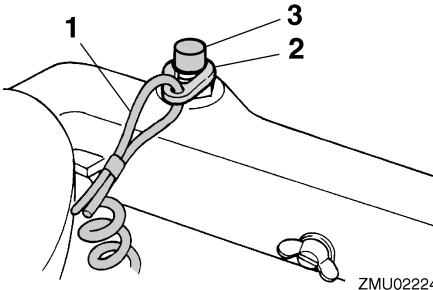

1. Cord
2. Clip
3. Engine shut-off switch

EMU26002

Engine stop button

The engine stop button stops the engine when the button is pushed.

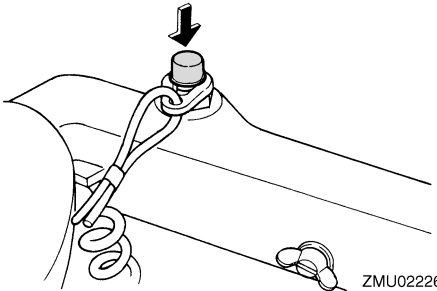

EMU26030

Choke knob

To supply the engine with the rich fuel mixture required to start, pull out this knob. The choke knob has the 4 operating positions shown in the following illustration.

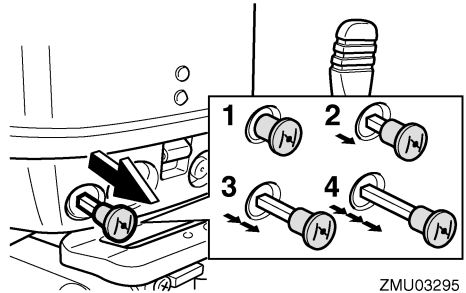

1. Use to start a hot engine
2. Use to warm up a cold engine or restart a warm engine
3. Use to warm up a cold engine or restart a warm engine
4. Use to start a cold engine

EMU26073

Manual starter handle

The manual starter handle is used to crank and start the engine.

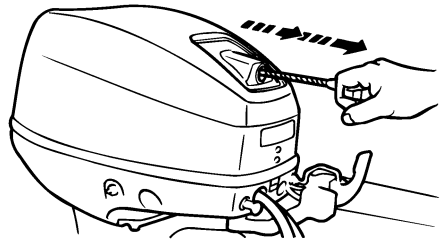

EMU26122

Steering friction adjuster

A friction device provides adjustable resistance to the steering mechanism, and can be set according to operator preference. An adjusting screw or bolt is located on the swivel bracket.

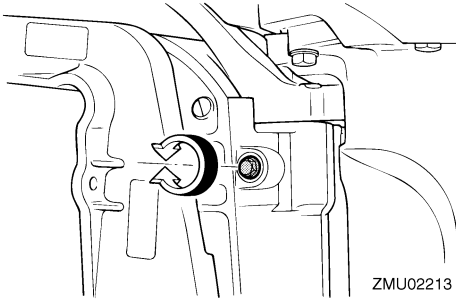

To increase resistance, turn the adjuster clockwise.

To decrease resistance, turn the adjuster counterclockwise.

EWU00040

WARNING

Do not overtighten the friction adjuster. If there is too much resistance, it could be difficult to steer, which could result in an accident.

EMU26262

Trim rod (tilt pin)

The position of the trim rod determines the minimum trim angle of the outboard motor in relation to the transom.

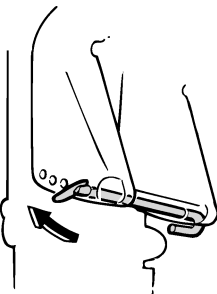



EMU30440

Tilt lock mechanism

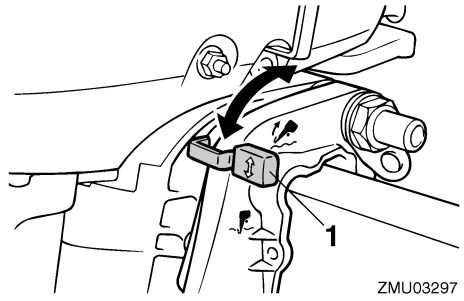
The tilt lock mechanism is used to prevent the outboard motor from lifting out of the water when in reverse gear.



1. Tilt lock lever

To tilt the outboard motor up, set the tilt lock lever to the “” (up) position. To tilt the outboard motor down, set the tilt lock lever to the “” (down) position.

EMU26333

Tilt support bar

The tilt support bar keeps the outboard motor in the tilted up position.

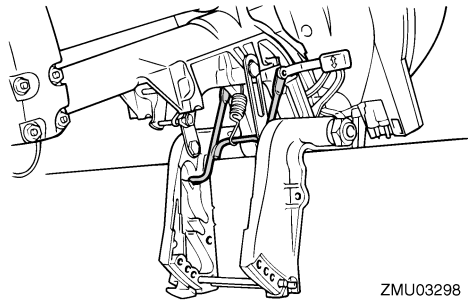

ECM01660

NOTICE

Do not use the tilt support bar when trailering the boat. The outboard motor could shake loose from the tilt support and fall. If the motor cannot be trailered in the normal running position, use an additional support device to secure it in the tilt position.

Components

EMU26373

Cowling lock lever(s) (turn type)

To remove the engine top cowling, turn the cowling lock lever(s) and lift off the cowling. When installing the cowling, check to be sure it fits properly in the rubber seal. Then lock the cowling again by returning the cowling lock lever(s) to the lock position.

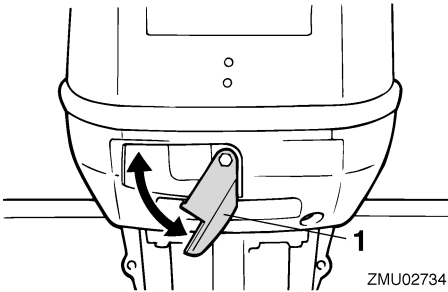

ZMU02734

1. Cowling lock lever(s)

EMU26410

2-pin connector

AC 12 V-40/60/80W power is delivered through this connector. When using it, keep in mind the following points:

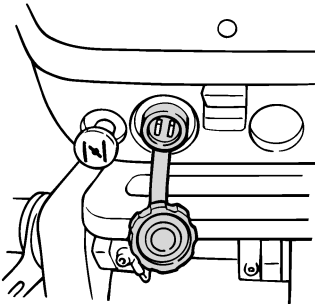

ZMU03299

- Use a genuine Yamaha connector.
- Use lighting equipment only.
- Connect lighting equipment directly to the 2-pin connector.
- Capacity of the lighting equipment must be more than 12 V-40/60/80W; otherwise the bulb could burn out.

- When the connector is not in use, place the cap on it.

ECM01000

NOTICE

Do not connect the 2-pin connector directly to the battery terminals. Otherwise the electric system will be damaged.

EMU26420

Battery charging information

If you need to charge the battery, use a genuine charge cable to make the charging circuit. For details on the cable connections, consult your Yamaha dealer.

TIP:

- Do not use the 2-pin connector while charging. The battery will not be charged.
- If you need to use lighting equipment while charging the battery, connect it to the battery, not to the 2-pin connector.

EMU26902

Installation

The information presented in this section is intended as reference only. It is not possible to provide complete instructions for every possible boat and motor combination. Proper mounting depends in part on experience and the specific boat and motor combination.

EWM01590

WARNING

- **Overpowering a boat could cause severe instability. Do not install an outboard motor with more horsepower than the maximum rating on the capacity plate of the boat. If the boat does not have a capacity plate, consult the boat manufacturer.**
- **Improper mounting of the outboard motor could result in hazardous conditions such as poor handling, loss of control, or fire hazards. For permanently mounted models, your dealer or other person experienced in proper rigging should mount the motor.**

EMU26911

Mounting the outboard motor

EWM01720

WARNING

Your dealer or other person experienced in proper outboard motor mounting should show you how to mount your outboard motor.

The outboard motor should be mounted so that the boat is well balanced. Otherwise, the boat could be hard to steer. For single-engine boats, mount the outboard motor on the centerline (keel line) of the boat.

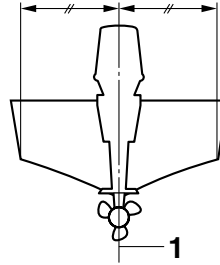

ZMU01760

1. Center line (keel line)

EMU26925

Mounting height

To run your boat at optimum efficiency, the water resistance (drag) of the boat and outboard motor must be made as little as possible. The mounting height of the outboard motor greatly affects the water resistance. If the mounting height is too high, cavitation tends to occur, thus reducing the propulsion; and if the propeller tips cut the air, the engine speed will rise abnormally and cause the engine to overheat. If the mounting height is too low, the water resistance will increase and thereby reduce engine efficiency. Mount the outboard motor so that the anti-cavitation plate is between the bottom of the boat and a level 25 mm (1 in) below it.

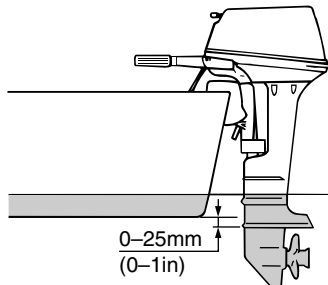

ZMU02011

Installation

ECM01634

NOTICE

- Make sure that the idle hole is high enough to prevent water from entering the engine even if the boat is stationary with the maximum load.
- Incorrect engine height or obstructions to the smooth flow of water (such as the design or condition of the boat, or accessories, such as transom ladders or depth finder transducers) can create airborne water spray while the boat is cruising. If the outboard motor is operated continuously in the presence of airborne water spray, enough water could enter the engine through the air intake opening in the top cowling to cause severe engine damage. Remove the cause of the airborne water spray.

TIP:

- The optimum mounting height of the outboard motor is affected by the boat and motor combination and the desired use. Test runs at different heights can help determine the optimum mounting height. Consult your Yamaha dealer or boat manufacturer for further information on determining the proper mounting height.
- For instructions on setting the trim angle of the outboard motor, see page 30.

EMU26973

Clamping the outboard motor

1. Place the outboard motor on the transom so that it is positioned as close to the center as possible. Tighten the transom clamp screws evenly and securely. Occasionally check the clamp screws for tightness during operation of the outboard motor because they could become loose due to engine vibration. **WARNING! Loose clamp screws could**

allow the outboard motor to fall off or move on the transom. This could cause loss of control and serious injury. Make sure the clamp screws are tightened securely. Occasionally check the screws for tightness during operation. [EWM00642]

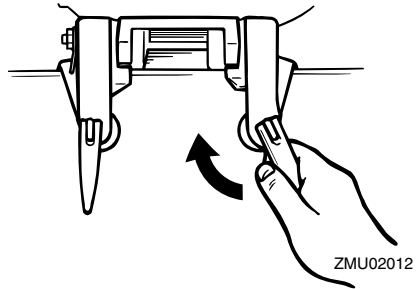

2. If the restraint cable attachment is equipped on your engine, a restraint cable or chain should be used. Attach one end to the restraint cable attachment and the other to a secure mounting point on the boat. Otherwise the engine could be completely lost if it accidentally falls off the transom.

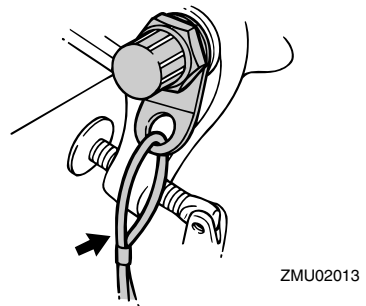

3. Secure the clamp bracket to the transom using the bolts provided with the outboard (if packed). For details, consult your Yamaha dealer. **WARNING! Avoid using bolts, nuts or washers other than those contained in the engine**

packaging. If used, they must be of at least the same quality of material and strength and must be tightened securely. After tightening, test run the engine and check their tightness.

[EWM00651]

Operation

EMU36381

First-time operation



EMU30174

Breaking in engine



Your new engine requires a period of break-in to allow mating surfaces of moving parts to wear in evenly. Correct break-in will help ensure proper performance and longer engine life. **NOTICE: Failure to follow the break-in procedure could result in reduced engine life or even severe engine damage.** [ECM00801]

EMU27060

Gasoline and engine oil mixing chart (50:1)

		50:1			
		1 L	12 L	14 L	24 L
		(0.26 US gal, 0.22 Imp gal)	(3.2 US gal, 2.6 Imp gal)	(3.7 US gal, 3.1 Imp gal)	(6.3 US gal, 5.3 Imp gal)
		0.02L (0.02 US qt, 0.02 Imp qt)	0.24 L (0.25 US qt, 0.21 Imp qt)	0.28 L (0.3US qt, 0.25 Imp qt)	0.48 L (0.51 US qt, 0.42 Imp qt)

ZMU02442

1. : Gasoline
2. : Engine oil

ECM00150

NOTICE

Be sure to mix gasoline and oil completely, otherwise the engine may be damaged.

EMU27074

Procedure for pre-mixed models

Run the engine under load (in gear with a propeller installed) for 10 hours as follows.

1. First 10 minutes:
Run the engine at the lowest possible speed. A fast idle in neutral is best.
2. Next 50 minutes:
Do not exceed half throttle (approximately 3000 r/min). Vary engine speed occasionally. If you have an easy-planing boat, accelerate at full throttle onto plane, then immediately reduce the throttle to 3000 r/min or less.

3. Next two hours:

Accelerate at full throttle onto plane, then reduce engine speed to three-quarter throttle (approximately 4000 r/min). Vary engine speed occasionally. Run at full throttle for one minute, then allow about 10 minutes of operation at three-quarter throttle or less to let the engine cool.

4. Remaining seven hours:

Run the engine at any speed. However, avoid operating at full throttle for more than 5 minutes at a time.

5. After the first 10 hours:

Operate the engine normally. Use the standard premix ratio of gasoline and oil. For details on mixing fuel and oil, see page 23.

EMU36400

Getting to know your boat

Different boats handle differently. Operate cautiously while you learn how your boat handles under different conditions and with different trim angles (see page 30).

EMU36413

Checks before starting engine

EWMO1921

WARNING

If any item in “Checks before starting engine” is not working properly, have it inspected and repaired before operating the outboard motor. Otherwise, an accident could occur.

ECM00120

NOTICE

Do not start the engine out of water. Overheating and serious engine damage can occur.

EMU37141

Fuel level

Be sure you have plenty of fuel for your trip. A good rule is to use 1/3 of your fuel to get to the destination, 1/3 to return, and to keep 1/3 as

an emergency reserve. With the boat level on a trailer or in the water, check the fuel level. For fuel filling instructions, see page 23.

EMU36571

Remove the top cowling

For the following checks, remove the top cowling from the bottom cowling. To remove the top cowling, release the cowling lock lever and lift off the top cowling.

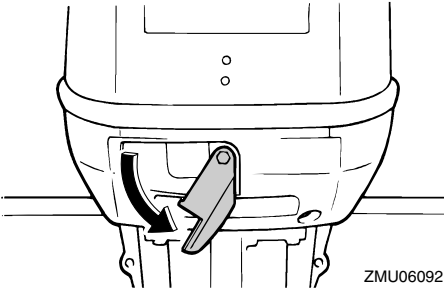

EMU36442

Fuel system

EWM00060

WARNING

Gasoline and its vapors are highly flammable and explosive. Keep away from sparks, cigarettes, flames, or other sources of ignition.

EWM00910

WARNING

Leaking fuel can result in fire or explosion.

- Check for fuel leakage regularly.
- If any fuel leakage is found, the fuel system must be repaired by a qualified mechanic. Improper repairs can make the outboard unsafe to operate.

EMU36451

Check for fuel leaks

- Check for fuel leaks or gasoline fumes in the boat.
- Check for fuel leakage from the fuel system.
- Check the fuel tank and fuel lines for cracks, swellings, or other damages.

EMU37321

Checking the fuel filter

Check that the fuel filter is clean and free of water. If any water is found in the fuel, or if a significant amount of debris is found, the fuel tank should be checked and cleaned by a Yamaha dealer.

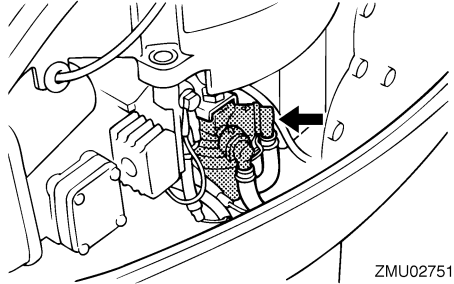

EMU36891

Controls

- Move the tiller handle fully to the left and right to make sure operation is smooth.
- Turn the throttle grip from the fully closed to the fully open position. Make sure that it turns smoothly and that it completely returns to the fully closed position.
- Look for loose or damaged connections of the throttle and shift cables.

EMU36483

Engine shut-off cord (lanyard)

Inspect the engine shut-off cord and clip for damage, such as cuts, breaks, and wear.

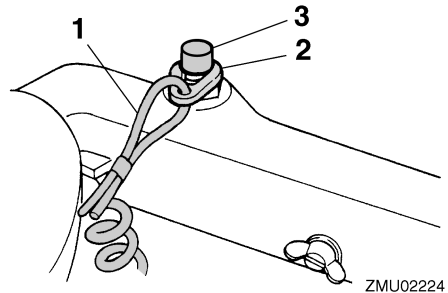

1. Cord
2. Clip

Operation

3. Engine shut-off switch

EMU27120

Oil

- Check to be sure you have plenty of oil for your trip.

EMU27141

Engine

- Check the engine and engine mounting.
- Look for loose or damaged fasteners.
- Check the propeller for damage.

EMU36954

Install top cowling

1. Be sure that the cowling lock lever is released.
2. Be sure that the rubber seal is seated all the way around the top cowling.
3. Place the top cowling on the bottom cowling.
4. Check to be sure the rubber seal is seated correctly between the top cowling and the bottom cowling.
5. Move the lever to lock the cowling as shown. **NOTICE: If the top cowling is not installed correctly, water spray under the top cowling can damage the engine, or the top cowling can blow off at high speeds.** [ECM01991]

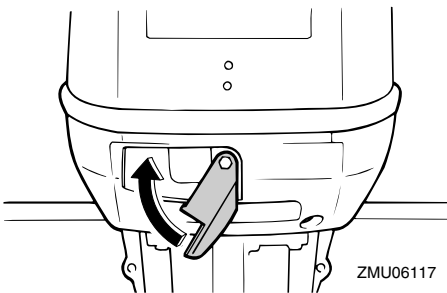

After installing, check the fitting of the top cowling by pushing it with both hands. If the top cowling is loose, have it repaired by your Yamaha dealer.

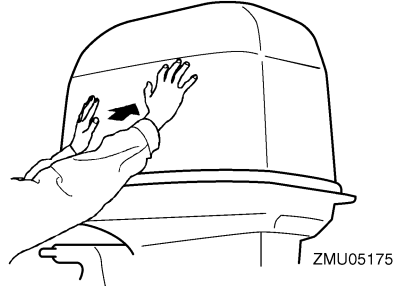

EMU27234

Filling fuel and engine oil

EMU27248

Filling fuel for portable tank

EWM01830

! WARNING

- Gasoline and its vapors are highly flammable and explosive. Always refuel according to this procedure to reduce the risk of fire and explosion.
- Gasoline is poisonous and can cause injury or death. Handle gasoline with care. Never siphon gasoline by mouth. If you should swallow some gasoline or inhale a lot of gasoline vapor, or get some gasoline in your eyes, see your doctor immediately. If gasoline spills on your skin, wash with soap and water. If gasoline spills on your clothing, change your clothes.

1. Be sure the engine is stopped.
2. Disconnect the fuel line from the fuel tank and tighten the air vent screw on the fuel tank cap.

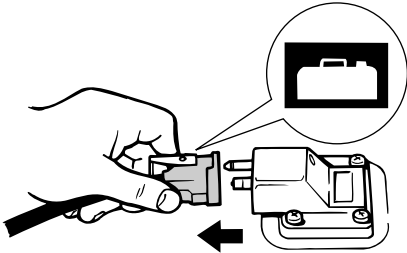

ZMU06621

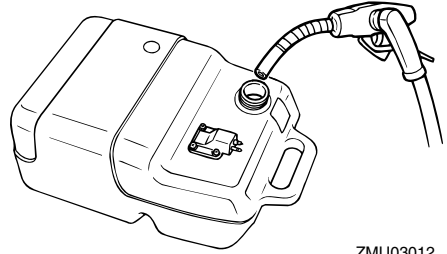

ZMU03012

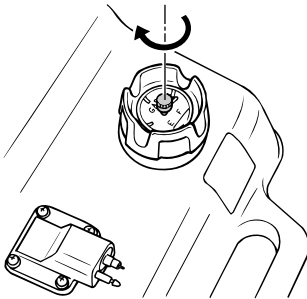

ZMU02041

3. Remove the portable tank from the boat.
4. Be sure you are in a well-ventilated outdoor area, either securely moored or trailered.
5. Do not smoke and keep away from sparks, flames, static electric discharge, or other sources of ignition.
6. If you use a portable container to store and dispense fuel, use only an approved GASOLINE container.
7. Touch the fuel nozzle to the filler opening or funnel to help prevent electrostatic sparks.
8. Fill the fuel tank, but do not overfill.

WARNING! Do not overfill. Otherwise fuel can expand and overflow if the temperature increases. [EWM02610]

Fuel tank capacity:
25.0 L (6.61 US gal, 5.50 Imp.gal)

9. Tighten the filler cap securely.
10. Wipe up any spilled gasoline immediately with dry rags. Dispose rags properly according to local laws or regulations.

EMU27406

Gasoline and oil mixing (100:1)



ECM00811

NOTICE



- Avoid using any oil other than the specified type.
- Use a thoroughly blended fuel-oil mixture.
- If the mixture is not thoroughly mixed, or if the mixing ratio is incorrect, the following problems could occur.
- Low oil ratio: Lack of oil could cause major engine trouble, such as piston seizure.
- High oil ratio: Too much oil could cause fouled spark plugs, smoky exhaust, and heavy carbon deposits.

	Gasoline to engine oil ratio
Break-in period	See page 21
After break-in	100:1

Operation

	100:1			
	1 L (0.26 US gal, 0.22 Imp gal)	12 L (3.2 US gal, 2.6 Imp gal)	14 L (3.7 US gal, 3.1 Imp gal)	24 L (6.3 US gal, 5.3 Imp gal)
	0.01 L (0.01 US qt, 0.01 Imp qt)	0.12 L (0.13 US qt, 0.11 Imp qt)	0.14 L (0.15 US qt, 0.12 Imp qt)	0.24 L (0.25 US qt, 0.21 Imp qt)

ZMU04910

- : Gasoline
- : Engine oil

If equipped with a portable fuel tank

- Pour oil into the portable fuel tank, and then add gasoline.

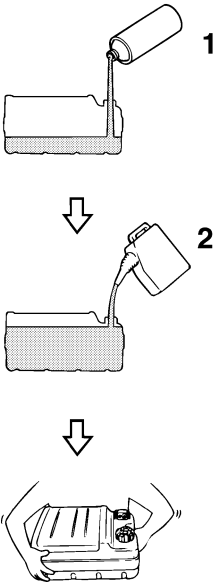

ZMU02394

- Engine oil
- Gasoline
- Replace the fuel tank cap and close tightly.
- Shake the fuel tank to mix the fuel thoroughly.

- Make sure that the oil and gasoline are mixed.

If equipped with a built-in fuel tank

- Pour oil into a clean fuel can, and then add gasoline.
- Replace the fuel can cap and close tightly.
- Shake the fuel can to mix the fuel thoroughly.
- Make sure that the oil and gasoline are mixed.
- Pour the gasoline and oil mixture into the built-in fuel tank.

TIP:

If using a permanently installed tank, pour the oil gradually as the gasoline is being added to the tank.

EMU27452

Operating engine

EWM00420

WARNING

- Before starting the engine, make sure that the boat is tightly moored and that you can steer clear of any obstructions. Be sure there are no swimmers in the water near you.
- When the air vent screw is loosened, gasoline vapor will be released. Gasoline is highly flammable, and its vapors are flammable and explosive. Refrain from smoking, and keep away from open flames and sparks while loosening the air vent screw.
- This product emits exhaust gases which contain carbon monoxide, a colorless, odorless gas which could cause brain damage or death when inhaled. Symptoms include nausea, dizziness, and drowsiness. Keep cockpit and cabin areas well ventilated. Avoid blocking exhaust outlets.

EMU27468

Sending fuel (portable tank)

1. If there is an air vent screw on the fuel tank cap, loosen it 2 or 3 turns.

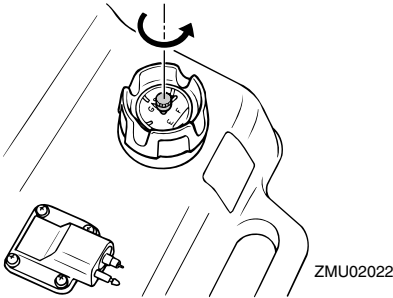

2. If there is a fuel joint on the motor, align the fuel joint on the fuel line with the fuel joint on the motor and firmly connect the fuel line to the joint while pinching the joint. Then firmly connect the other end of the fuel line to the joint on the fuel tank.

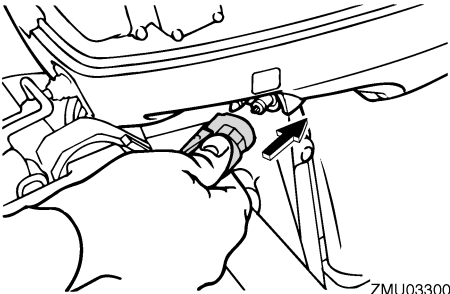

TIP:

Wipe up any spilled gasoline immediately with dry rags. Dispose rags properly according to local laws or regulations.

3. Squeeze the primer pump, with the arrow pointing up, until you feel it become firm. During engine operation place the tank horizontally, otherwise fuel cannot be drawn from the fuel tank.

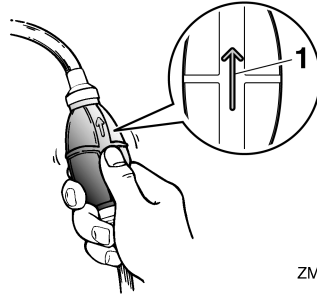

1. Arrow

EMU27493

Starting engine

EWM01600



WARNING

Before starting the engine, make sure that the boat is tightly moored and that you can steer clear of any obstructions. Be sure there are no swimmers in the water near you.

EMU27532

Manual start models

EWM01840



WARNING

- Failure to attached engine shut-off cord could result in a runaway boat if operator is ejected. Attach the engine shut-off cord to a secure place on your clothing, or your arm or leg while operating. Do not attach the cord to clothing that could tear loose. Do not route the cord where it could become entangled, preventing it from functioning.

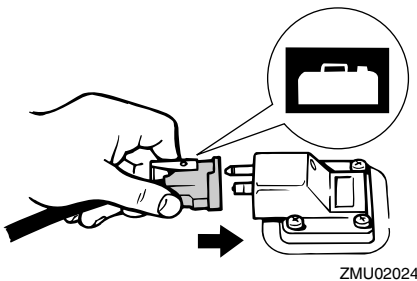

Operation

- Avoid accidentally pulling the cord during normal operation. Loss of engine power means the loss of most steering control. Also, without engine power, the boat could slow rapidly. This could cause people and objects in the boat to be thrown forward.

1. Place the gear shift lever in neutral.

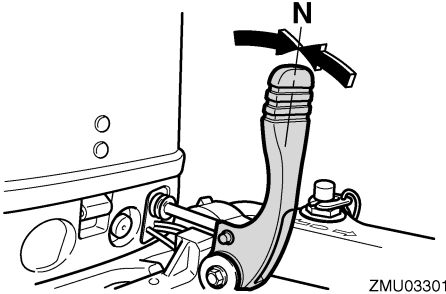

TIP:

The start-in-gear protection device prevents the engine from starting except when in neutral.

2. Attach the engine shut-off cord to a secure place on your clothing, or your arm or leg. Then install the clip on the other end of the cord into the engine shut-off switch.

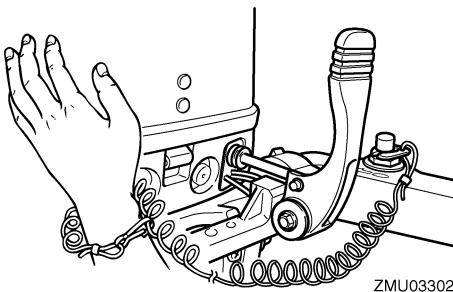

3. Place the throttle grip in the "START" (start) position.

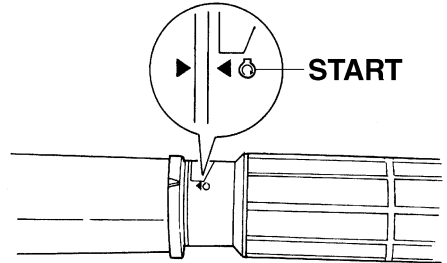

4. Pull out / turn the choke knob fully. Place the choke knob back in to the second or third position to warm up the engine after starting. When the engine has fully warmed up, replace the choke knob back in to its home position.

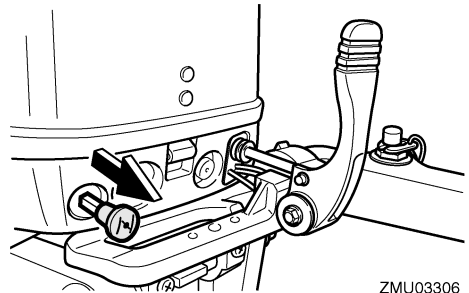

TIP:

- It is not necessary to use the choke when starting a warm engine.
 - If the choke knob is left in the pulled out position while the engine is running, the engine will run poorly or stall.
5. Pull the manual starter handle slowly until you feel resistance. Then give a strong pull straight out to crank and start the engine. Repeat if necessary.

ECM01810

NOTICE

If water is not flowing out of the pilot hole at all times while the engine is running, overheating and serious damage could occur. Stop the engine and check whether the cooling water inlet on the lower case or the cooling water pilot hole is blocked. Consult your Yamaha dealer if the problem cannot be located and corrected.

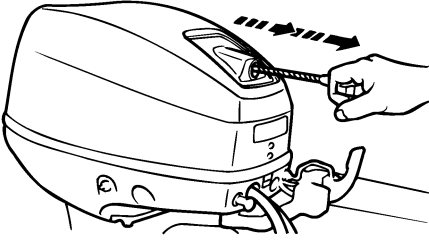

ZMU03296

6. After the engine starts, slowly return the manual starter handle to its original position before releasing it.
7. Slowly return the throttle grip to the fully closed position.

TIP:

- When the engine is cold, it needs to be warmed up. For further information, see page 28.
- If the engine does not start on the first try, repeat the procedure. If the engine fails to start after 4 or 5 tries, open the throttle a small amount (between 1/8 and 1/4) and try again. Also if the engine is warm and fails to start, open the throttle a same amount and try to start the engine again. If the engine still fails to start, see page 49.

EMU36510

Checks after starting engine

EMU36522

Cooling water

Check for a steady flow of water from the cooling water pilot hole. A continuous flow of water from the pilot hole indicates that the water pump is pumping water through the cooling water passages. If the cooling water passages are frozen, it may take a while for water to start flowing out of the pilot hole.

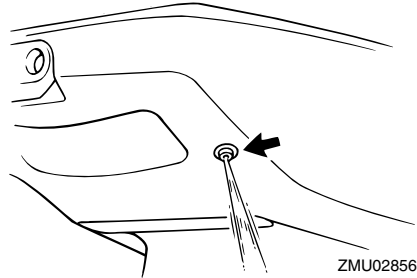

ZMU02856

EMU27670

Warming up engine

EMU27683

Choke start models

After starting the engine, allow it to idle for 3 minutes to warm up. Failure to do so will shorten engine life. Gradually return the choke knob to its home position as the engine warms up.

EMU36531

Checks after engine warm up

EMU36541

Shifting

While the boat is tightly moored, and without applying throttle, confirm that the engine shifts smoothly into forward and reverse, and back to neutral.

EMU36971

Stop switches

Perform the following procedure to check that the engine stop switch and engine shut-off switch operate properly.

Operation

- Start the engine, and then check that the engine stops when the engine stop button is pushed.
- Restart the engine, and then check that the engine stops when the clip is pulled from the engine shut-off switch.
- Check that the engine cannot be started with the clip removed from the engine shut-off switch.

EMU34550

Shifting

EWMO0180

WARNING

Before shifting, make sure there are no swimmers or obstacles in the water near you.

ECM01610

NOTICE

Warm up the engine before shifting into gear. Until the engine is warm, the idle speed may be higher than normal. High idle speed can prevent you from shifting back to neutral. If this occurs, stop the engine, shift to neutral, then restart the engine and allow it to warm up.

To shift out of neutral

Move the gear shift lever firmly and crisply forward (for forward gear) or backward (for reverse gear). Be sure to check that the tilt lock lever is in the lock/down position (if equipped) before operating in reverse.

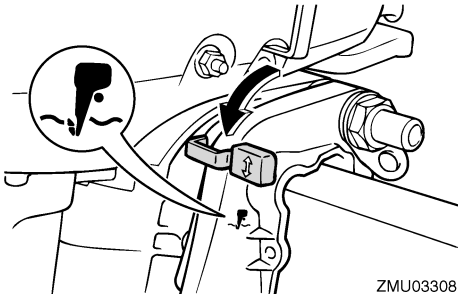

ZMU03308

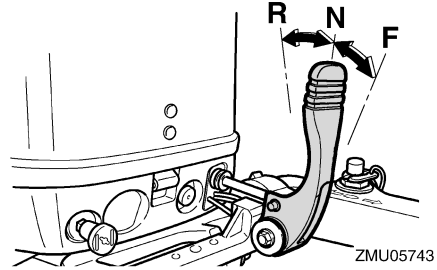

ZMU05743

To shift from in gear (forward/reverse) to neutral

1. Close the throttle so that the engine slows to idle speed.

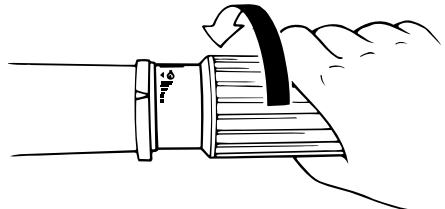

ZMU02030

2. After the engine is at idle speed in gear move the gear shift lever firmly and crisply into the neutral position.

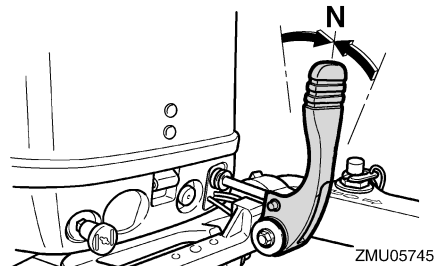

ZMU05745

EMU31742

Stopping boat

EWM01510

WARNING

- Do not use the reverse function to slow down or stop the boat as it could cause you to lose control, be ejected, or impact the steering wheel or other parts of the boat. This could increase the risk of serious injury. It could also damage the shift mechanism.
- Do not shift into reverse while traveling at planing speeds. Loss of control, boat swamping, or damage to the boat could occur.

The boat is not equipped with a separate braking system. Water resistance stops it after the throttle lever is moved back to idle. The stopping distance varies depending on gross weight, water surface conditions, and wind direction.

EMU27821

Stopping engine

Before stopping the engine, first let it cool off for a few minutes at idle or low speed. Stopping the engine immediately after operating at high speed is not recommended.

EMU27833

Procedure

1. Push and hold the engine stop button until the engine comes to a complete stop.

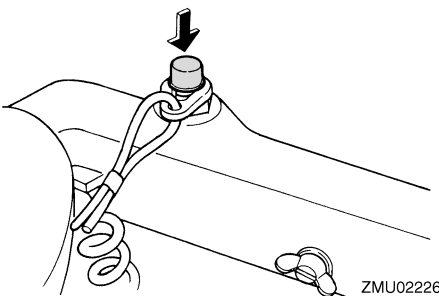

2. After stopping the engine, tighten the air vent screw on the fuel tank cap and set the fuel cock lever or knob to the closed position, if equipped.

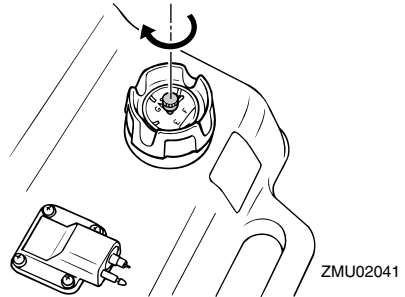

3. Disconnect the fuel line if you are using an external fuel tank.

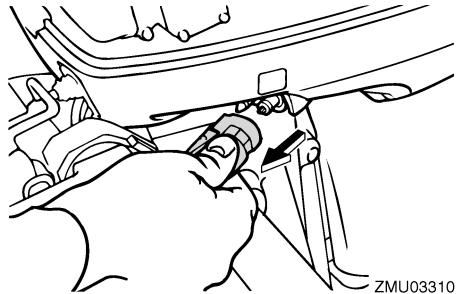

TIP:

If the outboard motor is equipped with an engine shut-off cord, the engine can also be stopped by pulling the cord and removing the clip from the engine shut-off switch.

EMU27862

Trimming outboard motor

EWM00740

WARNING

Excessive trim for the operating conditions (either trim up or trim down) can cause boat instability and can make steering the boat more difficult. This increases

Operation

the possibility of an accident. If the boat begins to feel unstable or is hard to steer, slow down and/or readjust the trim angle.

The trim angle of the outboard motor helps determine the position of the bow of the boat in the water. Correct trim angle will help improve performance and fuel economy while reducing strain on the engine. Correct trim angle depends upon the combination of boat, engine, and propeller. Correct trim is also affected by variables such as the load in the boat, sea conditions, and running speed.

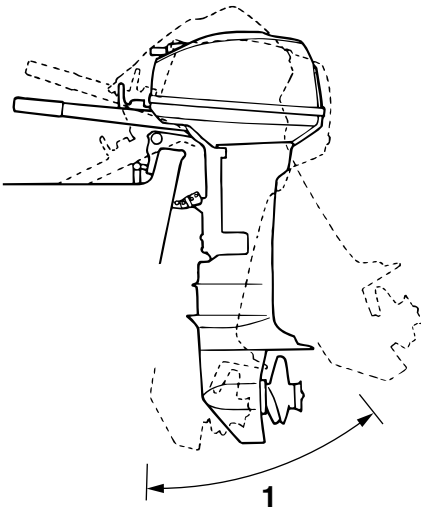

ZMU02043

1. Trim operating angle

EMU27872

Adjusting trim angle for manual tilt models

There are 4 or 5 holes provided in the clamp bracket to adjust the outboard motor trim angle.

1. Stop the engine.
2. Tilt the outboard motor up, and then remove the trim rod from the clamp bracket.

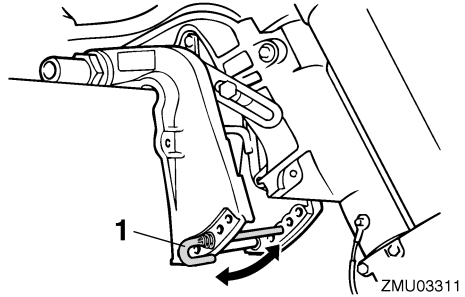

1. Trim rod

3. Reposition the rod in the desired hole. To raise the bow ("trim-out"), move the rod away from the transom. To lower the bow ("trim-in"), move the rod toward the transom. Make test runs with the trim set to different angles to find the position that works best for your boat and operating conditions.

EWMO0400

WARNING

- Stop the engine before adjusting the trim angle.
- Use care to avoid being pinched when removing or installing the rod.
- Use caution when trying a trim position for the first time. Increase speed gradually and watch for any signs of instability or control problems. Improper trim angle can cause loss of control.

TIP:

The outboard motor trim angle can be changed approximately 4 degrees by shifting the trim rod one hole.

EMU27912

Adjusting boat trim

When the boat is on plane, a bow-up attitude results in less drag, greater stability and efficiency. This is generally when the keel line of the boat is up about 3 to 5 degrees. With the bow up, the boat may have a greater tenden-

cy to steer to one side or the other. Compensate for this as you steer. When the bow of the boat is down, it is easier to accelerate from a standing start onto plane.

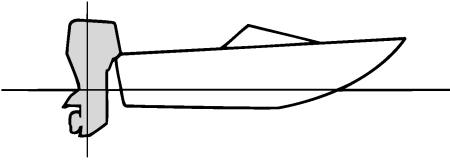

ZMU01784

Bow Up

Too much trim-out puts the bow of the boat too high in the water. Performance and economy are decreased because the hull of the boat is pushing the water and there is more air drag. Excessive trim-out can also cause the propeller to ventilate, which reduces performance further, and the boat may “porpoise” (hop in the water), which could throw the operator and passengers overboard.

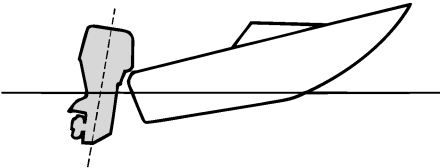

ZMU01785

Bow Down

Too much trim-in causes the boat to “plow” through the water, decreasing fuel economy and making it hard to increase speed. Operating with excessive trim-in at higher speeds also makes the boat unstable. Resistance at

the bow is greatly increased, heightening the danger of “bow steering” and making operation difficult and dangerous.

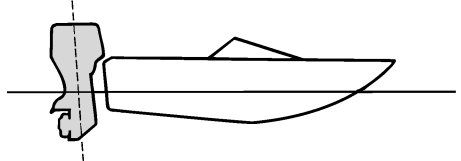

ZMU01786

TIP:

Depending on the type of boat, the outboard motor trim angle may have little effect on the trim of the boat when operating.

EMU27935

Tilting up and down

If the engine will be stopped for some time or if the boat is moored in shallows, the outboard motor should be tilted up to protect the propeller and lower casing from damage by collision with obstructions, and also to reduce salt corrosion.

EWM00222

WARNING

Make sure that no one is near the outboard motor when tilting the outboard motor up or down. Otherwise, body parts could be crushed between the outboard motor and the clamp bracket.

EWM00250

WARNING

Leaking fuel is a fire hazard. If there is a fuel joint on the outboard motor, disconnect the fuel line or close the fuel cock if the engine will be tilted for more than a few minutes. Otherwise fuel may leak.

Operation

ECM00241

NOTICE

- Before tilting the outboard motor, stop the engine by following the procedure on page 30. Never tilt the outboard motor while the engine is running. Severe damage from overheating can result.
- Do not tilt up the engine by pushing the tiller handle (if equipped) because this could break the handle.

EMU32662

Procedure for tilting up (manual tilt models)

1. Place the gear shift lever in neutral.

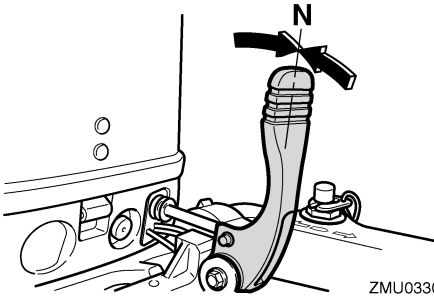

2. Disconnect the fuel line from the outboard motor.

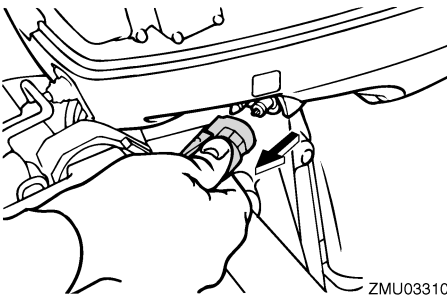

3. Place the tilt lock lever (if equipped) in the release/up position.

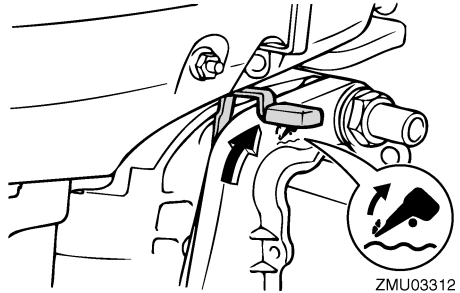

4. Pull up the shallow water lever (if equipped).
5. Hold the rear of the top cowling with one hand and tilt the engine up fully.
6. Push the tilt support knob into the clamp bracket. Or the tilt support bar will turn to the lock position automatically. **NOTICE:** Do not use the tilt support lever or knob when trailering the boat. The outboard motor could shake loose from the tilt support and fall. If the motor cannot be trailered in the normal running position, use an additional support device to secure it in the tilt position. For more detailed information, see page 36. [ECM01641]

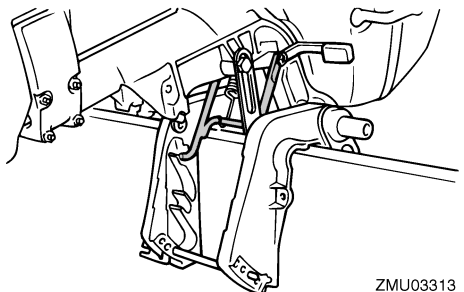

EMU28022

Procedure for tilting down (manual tilt models)

1. Place the tilt lock lever in the release/down position or return the shallow water lever to its original position.

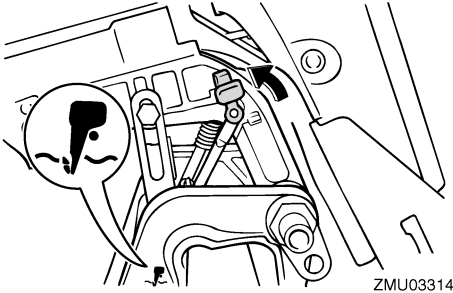

2. Slightly tilt the engine up until the tilt support bar is automatically released.
3. Slowly tilt the engine down.

EMU28061

Shallow water

EMU28073

Cruising in shallow water (manual tilt models)

EWM01781

WARNING

- Run the boat at the lowest possible speed when using the shallow water cruising system. The tilt lock mechanism does not work while the shallow water cruising system is being used. Hitting an underwater obstacle could cause the outboard motor to lift out of the water, resulting in loss of control.
- Use extra care when operating in reverse. Too much reverse thrust can cause the outboard motor to lift out of the water, increasing the chance of accident and personal injury.

ECM00260

NOTICE

Do not tilt the outboard motor up so that the cooling water inlet on the lower unit is above the surface of the water when setting up for and cruising in shallow water. Otherwise severe damage from overheating can result.

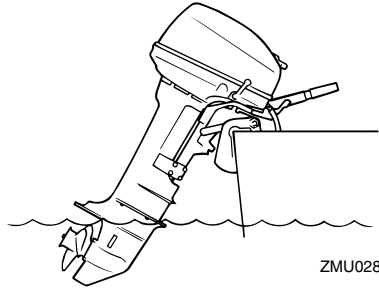

EMU32741

Procedure

1. Place the gear shift lever in neutral.

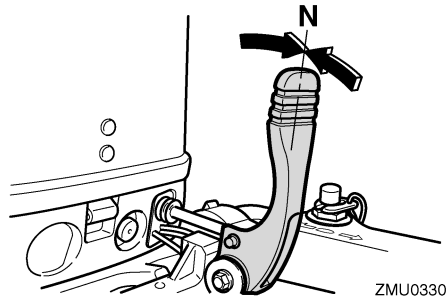

2. Place the tilt lock lever in the release/up position.

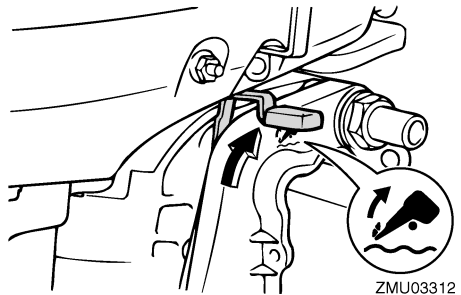

3. Slightly tilt the outboard motor up. The tilt support bar will lock automatically, supporting the outboard motor in a partially raised position. This outboard motor has 2 positions for shallow water cruising.

Operation

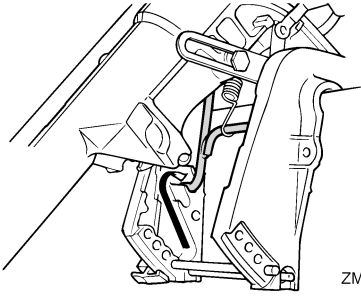

ZMU02748

4. To return the outboard motor to the normal running position, place the gear shift lever in neutral.
5. Place the tilt lock lever in the lock/down position, then slightly tilt the outboard motor up until the tilt support bar automatically returns to the free position.

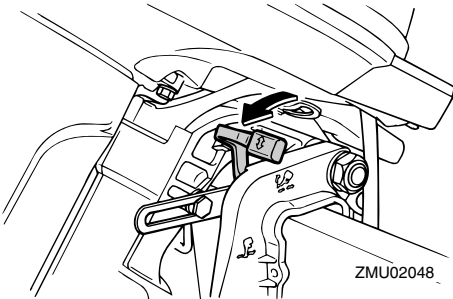

ZMU02048

6. Slowly lower the outboard motor to the normal position.

EMU28195

Cruising in other conditions

Cruising in salt water

After operating in salt water, flush the cooling water passages with fresh water to prevent them from becoming clogged. Also rinse the outside of the outboard motor with fresh water.

Cruising in muddy, turbid, or acidic water

Yamaha strongly recommends that you use the optional chromium-plated water pump kit (see page 10) if you use the outboard motor in

acidic water or water with a lot of sediment in it, such as muddy or turbid (cloudy) water. After operating in such water, flush the cooling passages with fresh water to prevent corrosion. Also rinse the outside of the outboard motor with fresh water.

EMU2822A

Transporting and storing outboard motor

EWM02620

WARNING

- **USE CARE** when transporting fuel tank, whether in a boat or car.
- **DO NOT** fill fuel container to maximum capacity. Gasoline will expand considerably as it warms up and can build up pressure in the fuel container. This can cause fuel leakage and a potential fire hazard.
- **Leaking fuel is a fire hazard.** When transporting and storing the outboard motor, disconnect the fuel line from the outboard motor to prevent fuel from leaking.
- **Never get under the outboard motor while it is tilted.** Severe injury could occur if the outboard motor accidentally falls.
- **Do not use the tilt support lever or knob when trailering the boat.** The outboard motor could shake loose from the tilt support and fall. If the outboard motor cannot be trailered in the normal running position, use an additional support device to secure it in the tilt position.

ECM02440

NOTICE

When storing the outboard motor for prolonged time, fuel must be drained from the fuel tank. The deteriorated fuel could clog the fuel line causing engine start difficulty or malfunction.

When storing or transporting the outboard motor, make sure to follow the procedure listed below.

- Disconnect the fuel line from the outboard motor.
- Tighten the fuel tank cap and its air vent screw.
- When the outboard motor is tilted prolonged time for mooring or trailering the boat, disconnect the fuel line from the outboard motor. Tighten the fuel tank cap and its air vent screw.

The outboard motor should be transported and stored in the normal running position. If there is insufficient road clearance in this position, then trailer the outboard motor in the tilt position using a motor support device such as a transom saver bar. Consult your Yamaha dealer for further details.

EMU28236

Clamp screw mounting models

When transporting or storing the outboard motor while removed from a boat, keep the outboard motor in the attitude shown.

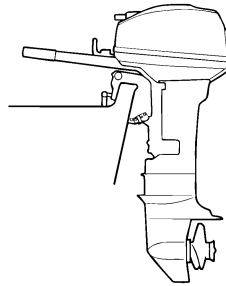

ZMU02796

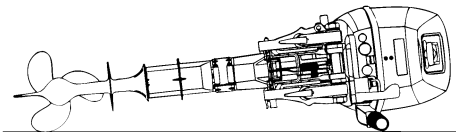

ZMU02458

Maintenance

TIP:

Place a towel or something similar under the outboard motor to protect it from damage.

EMU30272

Storing outboard motor

When storing your Yamaha outboard motor for prolonged periods of time (2 months or longer), several important procedures must be performed to prevent excessive damage.

It is advisable to have your outboard motor serviced by an authorized Yamaha dealer prior to storage. However, you, the owner, with a minimum of tools, can perform the following procedures.

ECM01411

NOTICE

- Do not place the outboard motor on its side before the cooling water has drained from it completely, otherwise water may enter the cylinder through the exhaust port and cause engine trouble.
- Store the outboard motor in a dry, well-ventilated place, not in direct sunlight.

EMU28305

Procedure

EMU28335

Flushing in a test tank

ECM00301

NOTICE

Before starting the engine, make sure to supply water to the cooling water passages. Otherwise, the engine could overheat and be damaged.

1. Wash the outboard motor body using fresh water. **NOTICE: Do not spray water into the air intake.** [ECM01840] For further information, see page 38.
2. Disconnect the fuel line from the motor or shut off the fuel cock, if equipped.
3. Remove the engine top cowling and silencer cover. Remove the propeller.

4. Install the outboard motor on the test tank. Fill the tank with fresh water to above the level of the anti-cavitation plate. **NOTICE: If the fresh water level is below the level of the anti-cavitation plate, or if the water supply is insufficient, engine seizure may occur.**

[ECM00291]

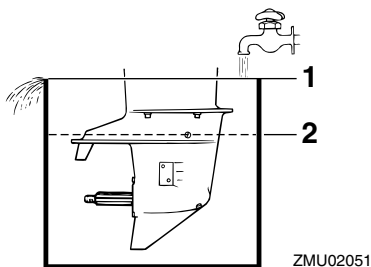

1. Water surface
 2. Lowest water level
5. Cooling system flushing is essential to prevent the cooling system from clogging up with salt, sand, or dirt. In addition, fogging/lubricating of the engine is mandatory to prevent excessive engine damage due to rust. Perform the flushing and fogging at the same time. **WARNING! Do not touch or remove electrical parts when starting or during operation. Keep hands, hair, and clothes away from the flywheel and other rotating parts while the engine is running.**

[EWM00091]

6. Run the engine at a fast idle for a few minutes in neutral position.
7. Just prior to turning off the engine, quickly spray "Fogging Oil" alternately into each carburetor or the fogging hole of the silencer cover, if equipped. When properly done, the engine will smoke excessively and almost stall.

8. Remove the outboard motor from the test tank.
9. Install the silencer cover/cap of fogging hole and top cowling.
10. If the "Fogging Oil" is not available, run the engine at a fast idle until the fuel system becomes empty and the engine stops.
11. Drain the cooling water completely out of the motor. Clean the body thoroughly.
12. If the "Fogging Oil" is not available, remove the spark plug(s). Pour a teaspoonful of clean engine oil into each cylinder. Crank several times manually. Replace the spark plug(s).
13. Drain the fuel from the fuel tank.

TIP:

Store the fuel tank in a dry, well-ventilated place, not in direct sunlight.

EMU28402

Lubrication

1. Install the spark plug(s) and torque to proper specification. For information on spark plug installation, see page 43.
2. Change the gear oil. For instructions, see page 46. Inspect the oil for the presence of water that indicates a leaky seal. Seal replacement should be performed by an authorized Yamaha dealer prior to use.
3. Grease all grease fittings. For further details, see page 42.

TIP:

For long-term storage, fogging the engine with oil is recommended. Contact your Yamaha dealer for information about fogging oil and procedures for your engine.

EMU28451

Cleaning the outboard motor

After use, wash the exterior of the outboard motor with fresh water. Flush the cooling system with fresh water.

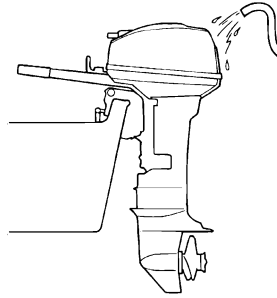

ZMU02411

EMU28461

Checking painted surface of outboard motor

Check the outboard motor for scratches, nicks, or flaking paint. Areas with damaged paint are more likely to corrode. If necessary, clean and paint the areas. A touch-up paint is available from your Yamaha dealer.

EMU37074

Periodic maintenance

EWMO1981

WARNING

These procedures require mechanical skills, tools, and supplies. If you do not have the proper skills, tools, or supplies to perform a maintenance procedure, have a Yamaha dealer or other qualified mechanic do the work.

The procedures involve disassembling the motor and exposing dangerous parts. To reduce the risk of injury from moving, hot, or electrical parts:

- Turn off the engine and keep engine shut-off cord (lanyard) with you when you perform maintenance unless otherwise specified.
- Allow the engine to cool before handling hot parts or fluids.
- Always completely reassemble the motor before operation.

Maintenance

EMU28511

Replacement parts

If replacement parts are necessary, use only genuine Yamaha parts or parts of equivalent design and quality. Any part of inferior quality may malfunction, and the resulting loss of control could endanger the operator and passengers. Yamaha genuine parts and accessories are available from your Yamaha dealer.

EMU34151

Severe operating conditions

Severe operating conditions involve one or more of the following types of operation on a regular basis:

- Operating continuously at or near maximum engine speed (rpm) for many hours
- Operating continuously at a low engine speed (rpm) for many hours
- Operating without sufficient time for engine to warm up and cool down
- Frequent quick acceleration and deceleration
- Frequent shifting
- Frequently starting and stopping the engine(s)
- Operation that fluctuates often between light and heavy cargo loads

Outboard motors operating under any of these above conditions require more frequent maintenance. Yamaha recommends that you do this service twice as often as specified in the maintenance chart. For example, if a particular service should be done at 50 hours, do it instead at 25 hours. This will help prevent more rapid deterioration of engine components.

EMU34446

Maintenance chart 1

TIP:

- Refer to the sections in this chapter for explanations of each owner-specific action.
- The maintenance cycle on these charts assume usage of 100 hours per year and regular flushing of the cooling water passages. Maintenance frequency should be adjusted when operating the engine under adverse conditions such as extended trolling.
- Disassembly or repairs may be necessary depending on the outcome of maintenance checks.
- Expendable or consumable parts and lubricants will lose their effectiveness over time and through normal usage regardless of the warranty period.
- When operating in salt water, muddy, other turbid (cloudy), acidic water, the engine should be flushed with clean water after each use.

The “●” symbol indicates the check-ups which you may carry out yourself.

The “○” symbol indicates work to be carried out by your Yamaha dealer.

Item	Actions	Initial	Every			
		20 hours (3 months)	100 hours (1 year)	300 hours (3 years)	500 hours (5 years)	
Anode(s) (external)	Inspection or replacement as necessary		●/○			
Anode(s) (cylinder head, thermostat cover)	Inspection or replacement as necessary					○
Anodes (exhaust cover, cooling water passage cover, Rectifier Regulator cover)	Replacement					○
Cooling water leakage	Inspection or replacement as necessary	○	○			
Cowling lock lever	Inspection		●/○			
Engine starting condition/noise	Inspection	●/○	●/○			
Engine idle speed/noise	Inspection	●/○	●/○			
Fuel filter (can be disassembled)	Inspection or replacement as necessary	●/○	●/○			
Fuel line (High pressure)	Inspection	●	●			
Fuel line (High pressure)	Inspection or replacement as necessary	○	○			
Fuel line (Low pressure)	Inspection	●	●			
Fuel line (Low pressure)	Inspection or replacement as necessary	○	○			

Maintenance

Item	Actions	Initial	Every			
		20 hours (3 months)	100 hours (1 year)	300 hours (3 years)	500 hours (5 years)	
Fuel pump	Inspection or replacement as necessary			○		
Fuel/engine oil leakage	Inspection	○	○			
Gear oil	Replacement	●/○	●/○			
Greasing points	Greasing	●/○	●/○			
Impeller/water pump housing	Inspection or replacement as necessary		○			
Impeller/water pump housing	Replacement			○		
Propeller/propeller nut/cotter pin	Inspection or replacement as necessary	●/○	●/○			
Shift link/shift cable	Inspection, adjustment or replacement as necessary	○	○			
Spark plug(s)	Inspection or replacement as necessary		●/○			
Spark plug caps/spark plug wires	Inspection or replacement as necessary	○	○			
Water from the cooling water pilot hole	Inspection	●/○	●/○			
Throttle link/throttle cable/throttle pick-up timing	Inspection, adjustment or replacement as necessary	○	○			
Thermostat	Inspection or replacement as necessary		○			
Cooling water inlet	Inspection	●/○	●/○			
Main switch/stop switch/choke switch	Inspection or replacement as necessary	○	○			
Wire harness connections/wire coupler connections	Inspection or replacement as necessary	○	○			
Fuel tank (Yamaha portable tank)	Inspection and cleaning as necessary		○			

EMU34451

Maintenance chart 2

Item	Actions	Every
		1000 hours
Exhaust guide/exhaust manifold	Inspection or replacement as necessary	○

EMU28943

Greasing

Yamaha grease A (water resistant grease)

Yamaha grease D (corrosion resistant grease; for propeller shaft)

9.9F, 15F

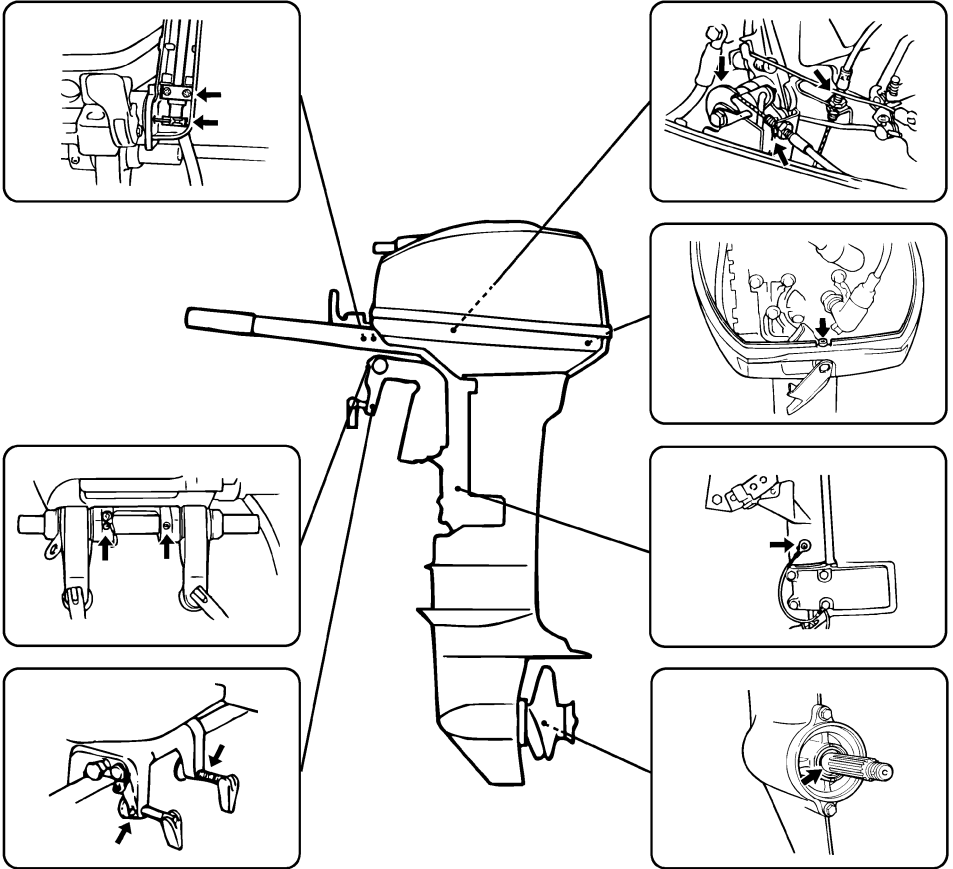

ZMU03315

Maintenance

EMU28957

Cleaning and adjusting spark plug

The spark plug is an important engine component and is easy to inspect. The condition of the spark plug can indicate something about the condition of the engine. For example, if the center electrode porcelain is very white, this could indicate an intake air leak or carburetion problem in that cylinder. Do not attempt to diagnose any problems yourself. Instead, take the outboard motor to a Yamaha dealer. You should periodically remove and inspect the spark plug because heat and deposits will cause the spark plug to slowly break down and erode.

1. Remove the spark plug caps from the spark plugs.
2. Remove the spark plug. If electrode erosion becomes excessive, or if carbon and other deposits are excessive, you should replace the spark plug with another of the correct type. **WARNING! When removing or installing a spark plug, be careful not to damage the insulator. A damaged insulator could allow external sparks, which could lead to explosion or fire.** [EWM00561]

Standard spark plug:
BR7HS-10

3. Be sure to use the specified spark plug, otherwise the engine may not operate properly. Before fitting the spark plug, measure the electrode gap with a wire thickness gauge; replace it if out of specification.

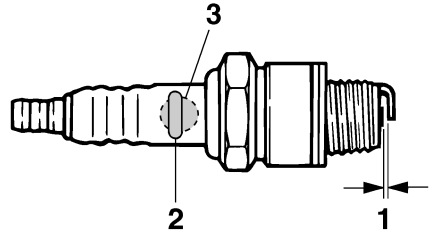

ZMU02179

1. Spark plug gap
2. Spark plug part number
3. Spark plug I.D. mark (NGK)

Spark plug gap:
0.9–1.0 mm (0.035–0.039 in)

4. When fitting the plug, wipe off any dirt from the threads, and then screw it in to the correct torque.

Spark plug torque:
25.0 Nm (2.55 kgf-m, 18.4 ft-lb)

TIP:

If a torque-wrench is not available when you are fitting a spark plug, a good estimate of the correct torque is 1/4 to 1/2 a turn past finger-tight. Have the spark plug adjusted to the correct torque as soon as possible with a torque-wrench.

EMU37450

Checking fuel filter

Check the fuel filter periodically. If any water or foreign matter is found in the filter, clean or replace it. For cleaning or replacement of the fuel filter, consult your Yamaha dealer.

EMU29044

Inspecting idle speed

EWM00451

WARNING

- Do not touch or remove electrical parts when starting or during operation.

- Keep hands, hair, and clothes away from the flywheel and other rotating parts while the engine is running.

ECM00490

NOTICE

This procedure must be performed while the outboard motor is in the water. A flushing attachment or test tank can be used.

If the boat is not equipped with a tachometer for the outboard motor, use a diagnostic tachometer for this procedure. Results may vary depending on whether testing is conducted with the flushing attachment, in a test tank, or with the outboard motor in the water.

1. Start the engine and allow it to warm up fully in neutral until it is running smoothly.
2. Once the engine has warmed up, verify whether the idle speed is set to specification. For idle speed specifications, see page 8. If you have difficulty verifying the idle speed, or the idle speed requires adjustment, consult a Yamaha dealer or other qualified mechanic.

EMU29114

Inspecting wiring and connectors

- Inspect that each connector is engaged securely.
- Inspect that each ground lead is properly secured.

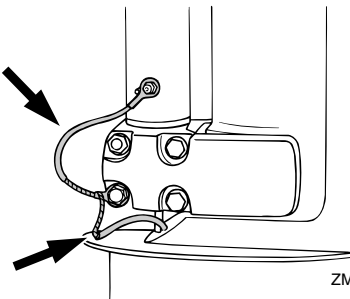

ZMU02087

EMU32112

Checking propeller

EWM01881

WARNING

You could be seriously injured if the engine accidentally starts when you are near the propeller. Before inspecting, removing, or installing the propeller, place the shift control in neutral, turn the main switch to “OFF” (off) and remove the key, and remove the clip from the engine shut-off switch. Turn off the battery cut-off switch if your boat has one.

Do not use your hand to hold the propeller when loosening or tightening the propeller nut. Put a wood block between the anti-cavitation plate and the propeller to prevent the propeller from turning.

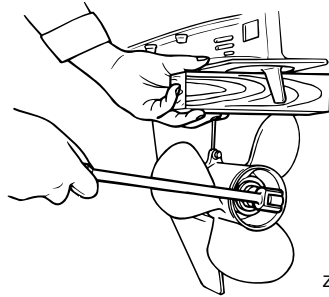

ZMU01897

Checkpoints

- Check each of the propeller blades for erosion from cavitation or ventilation, or other damage.
- Check the propeller shaft for damage.
- Check the splines for wear or damage.
- Check for fish line tangled around the propeller shaft.

Maintenance

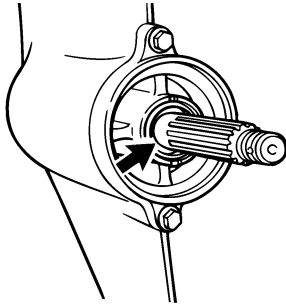

ZMU02274

- Check the propeller shaft oil seal for damage.

EMU30662

Removing propeller

EMU29197

Spline models

1. Straighten the cotter pin and pull it out using a pair of pliers.
2. Remove the propeller nut, washer, and spacer (if equipped). **WARNING! Do not use your hand to hold the propeller when loosening the propeller nut.**

[EWM01890]

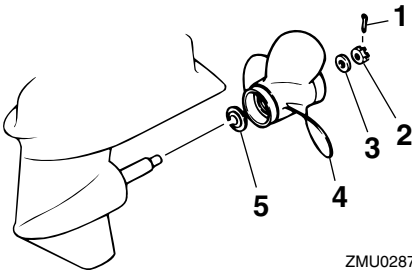

ZMU02877

1. Cotter pin
 2. Propeller nut
 3. Washer
 4. Propeller
 5. Thrust washer
3. Remove the propeller, washer (if equipped), and thrust washer.

EMU30672

Installing propeller

EMU29234

Spline models

ECM00501

NOTICE

Make sure to use a new cotter pin and bend the ends over securely. Otherwise, the propeller could come off during operation and be lost.

1. Apply Yamaha marine grease or a corrosion resistant grease to the propeller shaft.
2. Install the spacer (if equipped), thrust washer, washer (if equipped), and propeller on the propeller shaft. **NOTICE: Make sure to install the thrust washer before installing the propeller. Otherwise, the lower case and propeller boss could be damaged.** [ECM01881]
3. Install the spacer (if equipped) and the washer. Tighten the propeller nut to the specified torque.

Propeller nut tightening torque:
17.0 Nm (1.73 kgf-m, 12.5 ft-lb)

4. Align the propeller nut with the propeller shaft hole. Insert a new cotter pin in the hole and bend the cotter pin ends. **NOTICE: Do not reuse the cotter pin. Otherwise, the propeller can come off during operation.** [ECM01891]

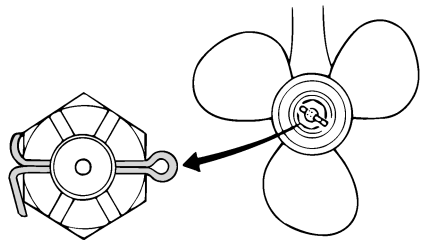

ZMU01805

TIP:

If the propeller nut does not align with the propeller shaft hole after tightening to the specified torque, tighten the nut further to align it with the hole.

EMU29289

Changing gear oil

EWM00800

WARNING

- Be sure the outboard motor is securely fastened to the transom or a stable stand. You could be severely injured if the outboard motor falls on you.
- Never get under the lower unit while it is tilted, even when the tilt support lever or knob is locked. Severe injury could occur if the outboard motor accidentally falls.

1. Tilt the outboard motor so that the gear oil drain screw is at the lowest point possible.
2. Place a suitable container under the gear case.
3. Remove the gear oil drain screw and gasket. **NOTICE:** If there is an excessive quantity of metal particles on the magnetic gear oil drain screw, this can indicate lower unit problem. Consult your Yamaha dealer. [ECM01900]

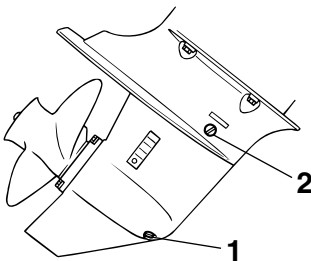

ZMU02064

1. Gear oil drain screw
2. Oil level plug

TIP:

- If a magnetic gear oil drain screw is equipped, remove all metal particles from the screw before installing it.
 - Always use new gaskets. Do not reuse the removed gaskets.
4. Remove the oil level plug and gasket to allow the oil to drain completely. **NOTICE:** Check the used gear oil after it has been drained. If the gear oil is milky or contains water or a large amount of metal particles, the gear case may be damaged. Have a Yamaha dealer check and repair the outboard motor. [ECM00713]

TIP:

For disposal of used oil, consult your Yamaha dealer.

5. Put the outboard motor in a vertical position. Using a flexible or pressurized filling device, inject the gear oil into the gear oil drain screw hole.

Recommended gear oil:
Hypoid gear oil SAE#90
Gear oil quantity:
0.250 L (0.264 US qt, 0.220 Imp.qt)

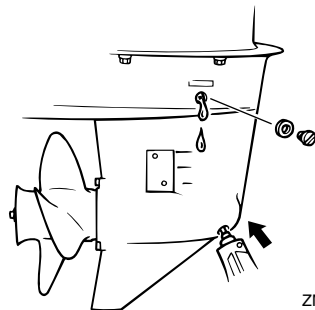

ZMU02065

Maintenance

- Put a new gasket on the oil level plug. When the oil begins to flow out of the oil level plug hole, insert and tighten the oil level plug.

Tightening torque:
9.0 Nm (0.92 kgf-m, 6.6 ft-lb)

- Put a new gasket on the gear oil drain screw. Insert and tighten the gear oil drain screw.

Tightening torque:
9.0 Nm (0.92 kgf-m, 6.6 ft-lb)

EMU29302

Cleaning fuel tank

EWM00920

WARNING

Gasoline is highly flammable, and its vapors are flammable and explosive.

- If you have any question about properly doing this procedure, consult your Yamaha dealer.
- Keep away from sparks, cigarettes, flames, or other sources of ignition when cleaning the fuel tank.
- Remove the fuel tank from the boat before cleaning it. Work only outdoors in an area with good ventilation.
- Wipe up any spilled fuel immediately.
- Reassemble the fuel tank carefully. Improper assembly can result in a fuel leak, which could result in a fire or explosion hazard.
- Dispose of old gasoline according to local regulations.

- Empty the fuel tank into an approved container.
- Pour a small amount of suitable solvent into the tank. Install the cap and shake the tank. Drain the solvent completely.

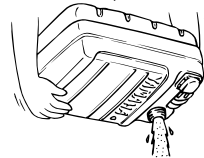
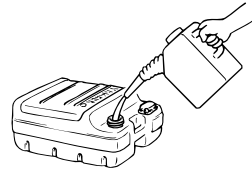

ZMU03231

- Remove the screws holding the fuel joint assembly. Pull the assembly out of the tank.

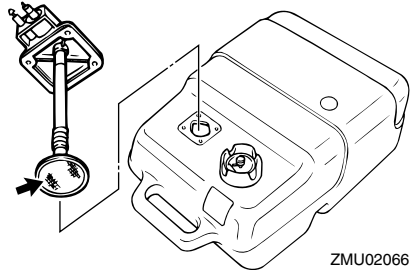

ZMU02066

- Clean the filter (located on the end of the suction pipe) in a suitable cleaning solvent. Allow the filter to dry.
- Replace the gasket with a new one. Reinstall the fuel joint assembly and tighten the screws firmly.

EMU29313

Inspecting and replacing anode(s)

Yamaha outboard motors are protected from corrosion by sacrificial anodes. Inspect the external anodes periodically. Remove scales from the surfaces of the anodes. Consult a Yamaha dealer for replacement of external anodes.

ECM00720

NOTICE

Do not paint anodes, as this would render them ineffective.

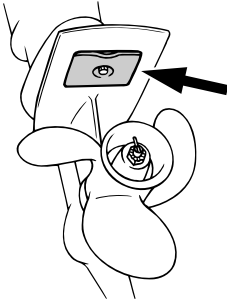

ZMU02067

TIP:

Inspect ground leads attached to external anodes on equipped models. Consult a Yamaha dealer for inspection and replacement of internal anodes attached to the power unit.

Trouble Recovery

EMU29427

Troubleshooting

A problem in the fuel, compression, or ignition systems can cause poor starting, loss of power, or other problems. This section describes basic checks and possible remedies, and covers all Yamaha outboard motors. Therefore some items may not apply to your model.

If your outboard motor requires repair, bring it to your Yamaha dealer.

If the engine trouble-alert indicator is flashing, consult your Yamaha dealer.

Starter will not operate.

Q. Is battery capacity weak or low?

A. Check battery condition. Use battery of recommended capacity.

Q. Are battery connections loose or corroded?

A. Tighten battery cables and clean battery terminals.

Q. Is fuse for electric start relay or electric circuit blown?

A. Check for cause of electric overload and repair. Replace fuse with one of correct amperage.

Q. Are starter components faulty?

A. Have serviced by a Yamaha dealer.

Q. Is shift lever in gear?

A. Shift to neutral.

Engine will not start (starter operates).

Q. Is fuel tank empty?

A. Fill tank with clean, fresh fuel.

Q. Is fuel contaminated or stale?

A. Fill tank with clean, fresh fuel.

Q. Is fuel filter clogged?

A. Clean or replace filter.

Q. Is starting procedure incorrect?

A. See page 26.

Q. Has fuel pump malfunctioned?

A. Have serviced by a Yamaha dealer.

Q. Are spark plug(s) fouled or of incorrect type?

A. Inspect spark plug(s). Clean or replace with recommended type.

Q. Are spark plug cap(s) fitted incorrectly?

A. Check and re-fit cap(s).

Q. Is ignition wiring damaged or poorly connected?

A. Check wires for wear or breaks. Tighten all loose connections. Replace worn or broken wires.

Q. Are ignition parts faulty?

A. Have serviced by a Yamaha dealer.

Q. Is engine shut-off cord (lanyard) not attached?

A. Attach cord.

Q. Are engine inner parts damaged?

A. Have serviced by a Yamaha dealer.

Engine idles irregularly or stalls.

Q. Are spark plug(s) fouled or of incorrect type?

A. Inspect spark plug(s). Clean or replace with recommended type.

Q. Is fuel system obstructed?

Trouble Recovery

A. Check for pinched or kinked fuel line or other obstructions in fuel system.

Q. Is fuel contaminated or stale?

A. Fill tank with clean, fresh fuel.

Q. Is fuel filter clogged?

A. Clean or replace filter.

Q. Have ignition parts failed?

A. Have serviced by a Yamaha dealer.

Q. Has alert system activated?

A. Find and correct cause of alert.

Q. Is spark plug gap incorrect?

A. Inspect and adjust as specified.

Q. Is ignition wiring damaged or poorly connected?

A. Check wires for wear or breaks. Tighten all loose connections. Replace worn or broken wires.

Q. Is specified engine oil not being used?

A. Check and replace oil as specified.

Q. Is thermostat faulty or clogged?

A. Have serviced by a Yamaha dealer.

Q. Are carburetor adjustments incorrect?

A. Have serviced by a Yamaha dealer.

Q. Is fuel pump damaged?

A. Have serviced by a Yamaha dealer.

Q. Is air vent screw on fuel tank closed?

A. Open air vent screw.

Q. Is choke knob pulled out?

A. Return to home position.

Q. Is motor angle too high?

A. Return to normal operating position.

Q. Is carburetor clogged?

A. Have serviced by a Yamaha dealer.

Q. Is fuel joint connection incorrect?

A. Connect correctly.

Q. Is throttle valve adjustment incorrect?

A. Have serviced by a Yamaha dealer.

Q. Is battery cable disconnected?

A. Connect securely.

Alert buzzer sounds or indicator lights.

Q. Is cooling system clogged?

A. Check water intake for restriction.

Q. Is engine oil level low?

A. Fill oil tank with specified engine oil.

Q. Is heat range of spark plug incorrect?

A. Inspect spark plug and replace it with recommended type.

Q. Is specified engine oil not being used?

A. Check and replace oil with specified type.

Q. Is engine oil contaminated or deteriorated?

A. Replace oil with fresh, specified type.

Q. Is oil filter clogged?

A. Have serviced by a Yamaha dealer.

Q. Has oil feed/injection pump malfunctioned?

A. Have serviced by a Yamaha dealer.

Trouble Recovery

Q. Is load on boat improperly distributed?

A. Distribute load to place boat on an even plane.

Q. Is water pump or thermostat faulty?

A. Have serviced by a Yamaha dealer.

Q. Is there excess water in fuel filter cup?

A. Drain filter cup.

Engine power loss.

Q. Is propeller damaged?

A. Have propeller repaired or replaced.

Q. Is propeller pitch or diameter incorrect?

A. Install correct propeller to operate outboard at its recommended speed (r/min) range.

Q. Is trim angle incorrect?

A. Adjust trim angle to achieve most efficient operation.

Q. Is motor mounted at incorrect height on transom?

A. Have motor adjusted to proper transom height.

Q. Has alert system activated?

A. Find and correct cause of alert.

Q. Is boat bottom fouled with marine growth?

A. Clean boat bottom.

Q. Are spark plug(s) fouled or of incorrect type?

A. Inspect spark plug(s). Clean or replace with recommended type.

Q. Are weeds or other foreign matter tangled on gear housing?

A. Remove foreign matter and clean lower unit.

Q. Is fuel system obstructed?

A. Check for pinched or kinked fuel line or other obstructions in fuel system.

Q. Is fuel filter clogged?

A. Clean or replace filter.

Q. Is fuel contaminated or stale?

A. Fill tank with clean, fresh fuel.

Q. Is spark plug gap incorrect?

A. Inspect and adjust as specified.

Q. Is ignition wiring damaged or poorly connected?

A. Check wires for wear or breaks. Tighten all loose connections. Replace worn or broken wires.

Q. Have electrical parts failed?

A. Have serviced by a Yamaha dealer.

Q. Is specified fuel not being used?

A. Replace fuel with specified type.

Q. Is specified engine oil not being used?

A. Check and replace oil with specified type.

Q. Is thermostat faulty or clogged?

A. Have serviced by a Yamaha dealer.

Q. Is air vent screw closed?

A. Open the air vent screw.

Q. Is fuel pump damaged?

A. Have serviced by a Yamaha dealer.

Q. Is fuel joint connection incorrect?

Trouble Recovery

A. Connect correctly.

Q. Is heat range of spark plug incorrect?

A. Inspect spark plug and replace it with recommended type.

Q. Is high pressure fuel pump drive belt broken?

A. Have serviced by a Yamaha dealer.

Q. Is engine not responding properly to shift lever position?

A. Have serviced by a Yamaha dealer.

Engine vibrates excessively.

Q. Is propeller damaged?

A. Have propeller repaired or replaced.

Q. Is propeller shaft damaged?

A. Have serviced by a Yamaha dealer.

Q. Are weeds or other foreign matter tangled on propeller?

A. Remove and clean propeller.

Q. Is motor mounting bolt loose?

A. Tighten bolt.

Q. Is steering pivot loose or damaged?

A. Tighten or have serviced by a Yamaha dealer.

EMU29433

Temporary action in emergency

EMU29441

Impact damage

EWM00870

WARNING

The outboard motor can be seriously damaged by a collision while operating or trailering. Damage could make the outboard motor unsafe to operate.

If the outboard motor hits an object in the water, follow the procedure below.



1. Stop the engine immediately.
2. Check the control system and all components for damage. Also, check the boat for damage.
3. Whether damage is found or not, return to the nearest harbor slowly and carefully.
4. Have a Yamaha dealer check the outboard motor before operating it again.

EMU29533

Starter will not operate

If the starter mechanism does not operate (the engine cannot be cranked with the starter), the engine can be started with an emergency starter rope.

EWM01022

WARNING

- Use this procedure only in an emergency to return to the nearest port for repairs.
- When the emergency starter rope is used to start the engine, the start-in-gear protection device does not operate. Make sure the remote control lever is in neutral. Otherwise the boat could unexpectedly start to move, which could result in an accident.
- Attach the engine shut-off cord to a secure place on your clothing, or your arm or leg while operating the boat.

Trouble Recovery

- Do not attach the cord to clothing that could tear loose. Do not route the cord where it could become entangled, preventing it from functioning.
- Avoid accidentally pulling the cord during normal operation. Loss of engine power means the loss of most steering control. Also, without engine power, the boat could slow rapidly. This could cause people and objects in the boat to be thrown forward.
- Make sure no one is standing behind you when pulling the starter rope. It could whip behind you and injure someone.
- An unguarded, rotating flywheel is very dangerous. Keep loose clothing and other objects away when starting the engine. Use the emergency starter rope only as instructed. Do not touch the flywheel or other moving parts when the engine is running. Do not install the starter mechanism or top cowling after the engine is running.
- Do not touch the ignition coil, spark plug wire, spark plug cap, or other electrical components when starting or operating the motor. You could get an electrical shock.

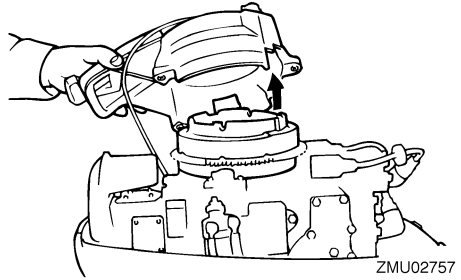

4. Prepare the engine for starting. For further information, see page 26. Be sure the engine is in neutral and that the clip is attached to the engine shut-off switch. The main switch must be "ON" (on), if equipped.
5. If equipped the choke knob, pull out it when the engine is cold. After the engine starts, gradually return the choke knob to its home position as the engine warms up.
6. Insert the knotted end of the emergency starter rope into the notch in the flywheel rotor and wind the rope several turns around the flywheel clockwise.
7. Give a strong pull straight out to crank and start the engine. Repeat if necessary.

EMU29562

Emergency starting engine

1. Remove the top cowling.
2. Remove the start-in-gear protection cable from the starter, if equipped.
3. Remove the starter/flywheel cover after removing the bolt(s).

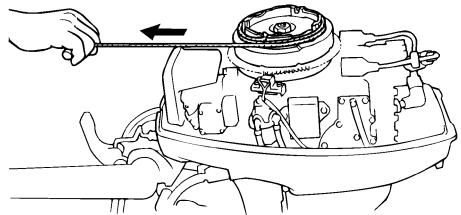

ZMU02758

EMU33501

Treatment of submerged motor

If the outboard motor is submerged, immediately take it to a Yamaha dealer. Otherwise some corrosion may begin almost immediately. **NOTICE: Do not attempt to run the outboard motor until it has been completely inspected.** [ECM00401]



YAMAHA MOTOR CO., LTD.

Printed in Japan

March 2010-0.1 × 1 CR

Printed on recycled paper