



**YAMAHA**



**F150A  
FL150A**

**OWNER'S MANUAL**

**63P-28199-76-E0**

 **Read this owner's manual carefully before operating or working on your outboard motor. Keep this manual onboard in a waterproof bag when boating. This manual should stay with the outboard motor if it is sold.**

# Important manual information

EMU25103

## To the owner

Thank you for choosing a Yamaha outboard motor. This Owner's Manual contains information needed for proper operation, maintenance and care. A thorough understanding of these simple instructions will help you obtain maximum enjoyment from your new Yamaha. If you have any question about the operation or maintenance of your outboard motor, please consult a Yamaha dealer.

In this Owner's Manual particularly important information is distinguished in the following ways.



The Safety Alert Symbol means ATTENTION! BECOME ALERT! YOUR SAFETY IS INVOLVED!

EWM00780



### WARNING

**Failure to follow WARNING instructions could result in severe injury or death to the machine operator, a bystander, or a person inspecting or repairing the outboard motor.**

ECM00700

### CAUTION:

**A CAUTION indicates special precautions that must be taken to avoid damage to the outboard motor.**

### NOTE:

A NOTE provides key information to make procedures easier or clearer.

Yamaha continually seeks advancements in product design and quality. Therefore, while this manual contains the most current product information available at the time of printing, there may be minor discrepancies between

your machine and this manual. If there is any question concerning this manual, please consult your Yamaha dealer.

To ensure long product life, Yamaha recommends that you use the product and perform the specified periodic inspections and maintenance by correctly following the instructions in the owner's manual. Any damage resulting from neglect of these instructions is not covered by warranty.

Some countries have laws or regulations restricting users from taking the product out of the country where it was purchased, and it may be impossible to register the product in the destination country. Additionally, the warranty may not apply in certain regions. When planning to take the product to another country, consult the dealer where the product was purchased for further information.

If the product was purchased used, please consult your closest dealer for customer registration, and to be eligible for the specified services.

### NOTE:

The F150AET, FL150AET and the standard accessories are used as a base for the explanations and illustrations in this manual. Therefore some items may not apply to every model.

EMU25121

### F150A, FL150A OWNER'S MANUAL

©2007 by Yamaha Motor Co., Ltd.  
1st Edition, July 2007

All rights reserved.

**Any reprinting or unauthorized use  
without the written permission of  
Yamaha Motor Co., Ltd.  
is expressly prohibited.**

Printed in Japan

# Table of contents

---

<b>General information .....</b>	<b>1</b>	<b>Basic components .....</b>	<b>12</b>
Identification numbers record .....	1	Main components.....	12
Outboard motor serial number .....	1	Remote control .....	13
Key number .....	1	Remote control lever .....	14
EC label.....	1	Neutral interlock trigger .....	14
Read manuals and labels.....	2	Neutral throttle lever .....	14
Warning labels.....	2	Free accelerator .....	15
<b>Safety information.....</b>	<b>6</b>	Throttle friction adjuster .....	15
Safety information .....	6	Engine shut-off switch .....	16
Rotating parts .....	6	Main switch.....	16
Hot parts .....	6	Power trim and tilt switch on remote	
Electric shock .....	6	control .....	17
Power trim and tilt.....	6	Power trim and tilt switch on bottom	
Engine shut-off cord .....	6	engine cowling .....	17
Gasoline .....	6	Power trim and tilt switches	
Gasoline exposure and spills .....	6	(twin binnacle type) .....	18
Carbon monoxide.....	7	Trim tab with anode .....	18
Modifications .....	7	Tilt support lever for power trim and	
Boating safety .....	7	tilt model.....	19
Alcohol and drugs.....	7	Top cowling lock lever	
Personal flotation devices .....	7	(pull up type) .....	19
People in the water.....	7	Flushing device .....	20
Passengers .....	7	Fuel filter/Water separator.....	20
Overloading .....	7	Digital tachometer .....	20
Avoid collisions.....	7	Low oil pressure-warning indicator ...	20
Weather.....	8	Overheat-warning indicator	
Passenger training .....	8	(digital type) .....	21
Boating safety publications.....	8	Speedometer (digital type) .....	21
Laws and regulations .....	8	Trim meter (digital type) .....	22
<b>Basic requirements .....</b>	<b>9</b>	Hour meter (digital type).....	22
Fueling instructions .....	9	Trip meter .....	23
Gasoline .....	9	Clock .....	23
Engine oil.....	9	Fuel gauge .....	23
Installation requirements .....	10	Fuel warning indicator .....	24
Boat horsepower rating .....	10	Low battery voltage-warning	
Mounting motor .....	10	indicator .....	24
Remote control requirements .....	10	Fuel management meter .....	24
Battery requirement.....	10	Fuel flow meter .....	25
Propeller selection.....	11	Fuel consumption meter.....	25
		Fuel economy .....	26
		Twin-engine speed synchronizer.....	26
		Water separator-warning indicator ...	27
		6Y8 Multifunction meters.....	27
		Tachometer unit .....	27
		Speed & fuel meter unit.....	30

# Table of contents

Speedometer unit.....	31	Cruising in other conditions.....	48
Fuel management meter .....	32		
Warning system .....	33	<b>Maintenance .....</b>	<b>49</b>
Overheat warning.....	33	Specifications.....	49
Low oil pressure warning.....	33	Transporting and storing outboard	
<b>Operation .....</b>	<b>35</b>	motor.....	50
Installation .....	35	Storing outboard motor.....	50
Mounting the outboard motor .....	35	Procedure.....	51
Breaking in engine .....	36	Lubrication .....	52
Procedure for 4-stroke models.....	36	Battery care .....	53
Pre-operation checks .....	37	Flushing power unit .....	53
Fuel .....	37	Cleaning the outboard motor.....	54
Controls.....	37	Checking painted surface of motor...	54
Stop switches .....	37	<b>Periodic maintenance .....</b>	<b>55</b>
Engine .....	37	Replacement parts .....	55
Checking the engine oil level.....	37	Severe operating conditions.....	55
Filling fuel .....	38	Maintenance chart 1 .....	56
Operating engine.....	38	Maintenance chart 2.....	58
Feeding fuel.....	38	Greasing.....	59
Starting engine .....	38	Cleaning and adjusting spark plug ...	59
Warming up engine .....	40	Checking fuel system .....	60
Electric start models .....	40	Changing engine oil.....	61
Shifting .....	41	Checking wiring and connectors .....	63
Stopping boat .....	42	Exhaust leakage.....	63
Stopping engine .....	42	Water leakage .....	63
Procedure.....	42	Engine oil leakage .....	63
Trimming outboard motor.....	43	Checking power trim and tilt	
Adjusting trim angle		system.....	63
(Power trim and tilt).....	43	Checking propeller .....	64
Adjusting boat trim.....	44	Removing propeller .....	65
Tilting up and down .....	45	Installing propeller .....	65
Procedure for tilting up		Changing gear oil .....	66
(power trim and tilt models).....	45	Inspecting and replacing anode(s) ...	67
Procedure for tilting down		Checking battery	
(power trim and tilt models).....	47	(for electric start models) .....	67
Cruising in shallow water .....	47	Connecting the battery .....	68
Power trim and tilt models.....	47	Disconnecting the battery .....	69
		Checking top cowling .....	69
		Coating the boat bottom .....	70
		<b>Trouble Recovery.....</b>	<b>71</b>
		Troubleshooting.....	71
		Temporary action in emergency ...	74
		Impact damage.....	74

# Table of contents

---

Running single engine (twin engines).....	74
Replacing fuse.....	75
Power trim and tilt will not operate ...	75
Water separator-warning indicator blinks while cruising .....	76
Treatment of submerged motor.....	78

EMU25171

## Identification numbers record

EMU25183

### Outboard motor serial number

The outboard motor serial number is stamped on the label attached to the port side of the clamp bracket.

Record your outboard motor serial number in the spaces provided to assist you in ordering spare parts from your Yamaha dealer or for reference in case your outboard motor is stolen.

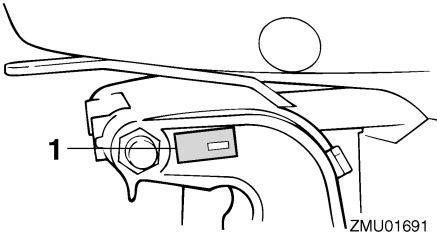

ZMU01691

1. Outboard motor serial number location

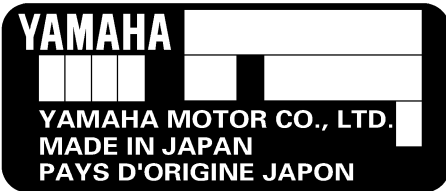

ZMU01692

EMU25190

### Key number

If a main key switch is equipped with the motor, the key identification number is stamped on your key as shown in the illustration. Record this number in the space provided for reference in case you need a new key.

--	--	--	--

ZMU01693

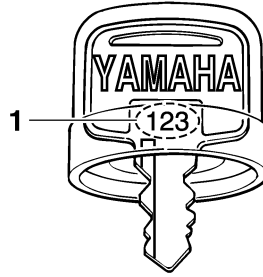

ZMU01694

1. Key number

EMU25202

### EC label

Engines affixed with this label conform to certain portions of the European Parliament directive relating to machinery. Refer to the label and the EC Declaration of Conformity for more details.

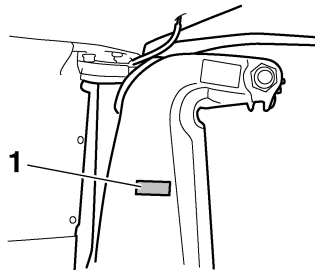

ZMU01695

1. EC label location

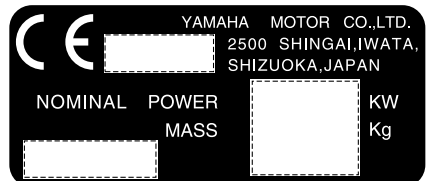

ZMU01696

# General information

---

EMU33520

## Read manuals and labels

Before operating or working on this motor:

- Read this manual.
- Read any manuals supplied with the boat.
- Read all labels on the outboard motor and the boat.

If you need any additional information, contact your Yamaha dealer.

EMU33831

## Warning labels

If these labels are damaged or missing, contact your Yamaha dealer for replacements.

**F150A, FL150A**

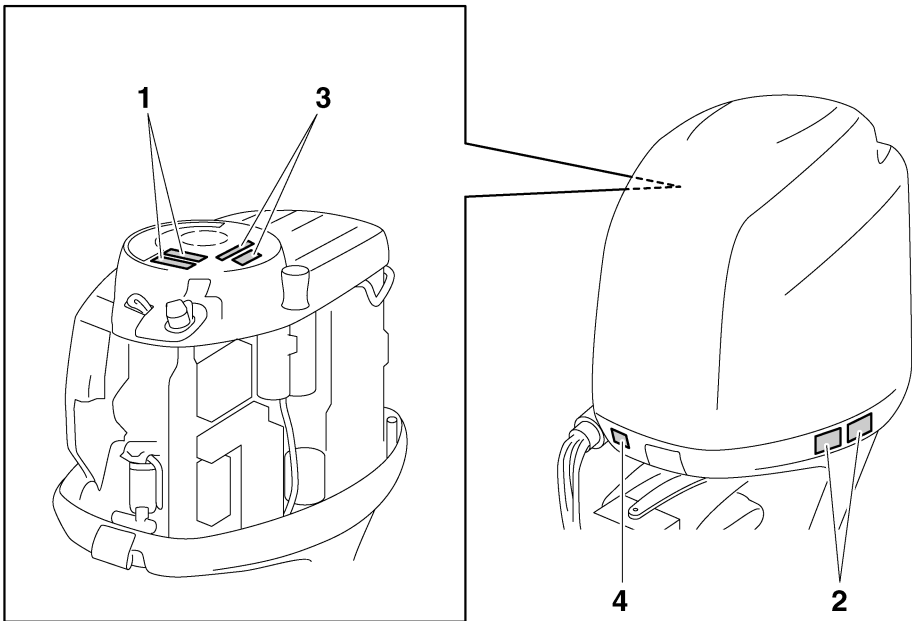

ZMU05686



1

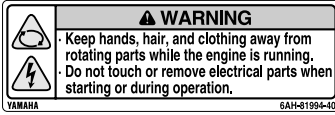

3

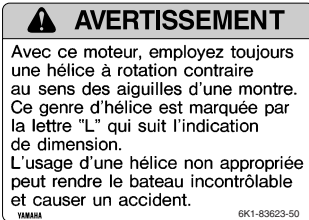
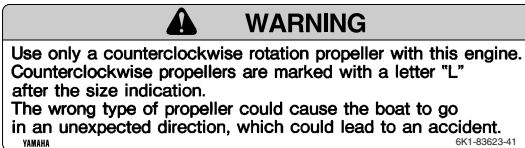

EMU34641

## Contents of labels

The above warning labels mean as follows.

1

EWM01681



- Keep hands, hair, and clothing away from rotating parts while the engine is running.
- Do not touch or remove electrical parts when starting or during operation.

2

EWM01671



- Read Owner's Manuals and labels.
- Wear an approved personal flotation device (PFD).

2

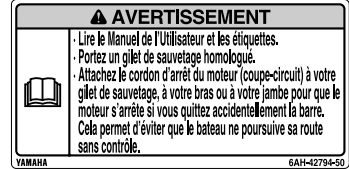
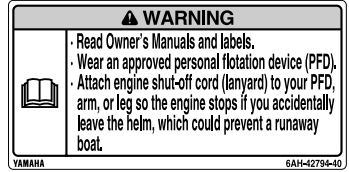

ZMU05708

- Attach engine shut-off cord (lanyard) to your PFD, arm, or leg so the engine stops if you accidentally leave the helm, which could prevent a runaway boat.

3

EWM01282



Use only a counterclockwise rotation propeller with this engine. Counterclockwise propellers are marked with a letter "L" after the size indication. The wrong type of propeller could cause the boat to go in an unexpected direction, which could lead to an accident.

# General information

---

EMU33850  
**Other labels**

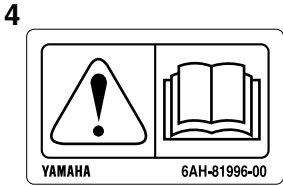

ZMU05711

Hazard caused by continuous rotation

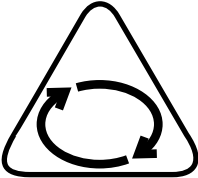

ZMU05665

EMU33841  
**Symbols**

The following symbols mean as follows.

Caution/Warning



ZMU05696

Electrical hazard

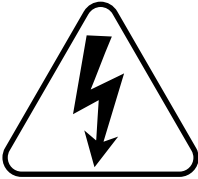

ZMU05666

Read Operator's Manual



ZMU05664

Remote control lever/gear shift lever operating direction, dual direction



ZMU05667

Engine start/ Engine cranking

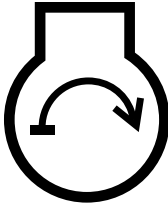

ZMU05668

# Safety information

---

EMU33621

## Safety information

Observe these precautions at all times.

EMU33630

### Rotating parts

Hands, feet, hair, jewelry, clothing, PFD straps, etc. can become entangled with internal rotating parts of the engine, resulting in serious injury or death.

Keep the top cowling in place whenever possible. Do not remove or replace the cowling with the engine running.

Only operate the engine with the cowling removed according to the specific instructions in the manual. Keep hands, feet, hair, jewelry, clothing, PFD straps, etc. away from any exposed moving parts.

EMU33640

### Hot parts

During and after operation, engine parts are hot enough to cause burns. Avoid touching any parts under the top cowling until the engine has cooled.

EMU33650

### Electric shock

Do not touch any electrical parts while starting or operating the engine. They can cause shock or electrocution.

EMU33660

### Power trim and tilt

Body parts can be crushed between the motor and the clamp bracket when the motor is trimmed or tilted. Keep body parts out of this area at all times. Be sure no one is in this area before operating the power trim and tilt mechanism.

The power trim and tilt switches operate even when the main switch is off. Keep people be away from the switches whenever working around the motor.

Never get under the lower unit while it is tilted, even when the tilt support lever is locked. Severe injury could occur if the outboard motor accidentally falls.

EMU33670

### Engine shut-off cord

Attach the engine shut-off cord so that the engine stops if the operator falls overboard or leaves the helm. This prevents the boat from running away under power and leaving people stranded, or running over people or objects.

Always attach the engine shut-off cord to a secure place on your clothing or your arm or leg while operating. Do not remove it to leave the helm while the boat is moving. Do not attach the cord to clothing that could tear loose, or route the cord where it could become entangled, preventing it from functioning.

Do not route the cord where it is likely to be accidentally pulled out. If the cord is pulled during operation, the engine will shut off and you will lose most steering control. The boat could slow rapidly, throwing people and objects forward.

EMU33810

### Gasoline

**Gasoline and its vapors are highly flammable and explosive.** Always, refuel according to the procedure on page 38 to reduce the risk of fire and explosion.

EMU33820

### Gasoline exposure and spills

Take care not to spill gasoline. If gasoline spills, wipe it up immediately with dry rags. Dispose of rags properly.

If any gasoline spills onto your skin, immediately wash with soap and water. Change clothing if gasoline spills on it.

If you swallow gasoline, inhale a lot of gasoline vapor, or get gasoline in your eyes, get immediate medical attention. Never siphon fuel by mouth.

EMU33900

**Carbon monoxide**

This product emits exhaust gases which contain carbon monoxide, a colorless, odorless gas which may cause brain damage or death when inhaled. Symptoms include nausea, dizziness, and drowsiness. Keep cockpit and cabin areas well ventilated. Avoid blocking exhaust outlets.

EMU33780

**Modifications**

Do not attempt to modify this outboard motor. Modifications to your outboard motor may reduce safety and reliability, and render the outboard unsafe or illegal to use.

EMU33740

**Boating safety**

This section includes a few of the many important safety precautions that you should follow when boating.

EMU33710

**Alcohol and drugs**

Never operate after drinking alcohol or taking drugs. Intoxication is one of the most common factors contributing to boating fatalities.

EMU33720

**Personal flotation devices**

Have an approved personal flotation device (PFD) on board for every occupant. Yamaha recommends that you must wear a PFD whenever boating. At a minimum, children and non-swimmers should always wear PFDs, and everyone should wear PFDs when there are potentially hazardous boating conditions.

EMU33730

**People in the water**

Always watch carefully for people in the water, such as swimmers, skiers, or divers, whenever the engine is running. When someone is in the water near the boat, shift into neutral and shut off the motor.

Stay away from swimming areas. Swimmers can be hard to see.

The propeller can keep moving even when the motor is in neutral. Shut off the engine when a person is in the water near you.

EMU33750

**Passengers**

Consult your boat manufacturer's instructions for details about appropriate passenger locations in your boat and be sure all passengers are positioned properly before accelerating and when operating above an idle speed. Standing or sitting in non-designated locations may result in being thrown either overboard or within the boat due to waves, wakes, or sudden changes in speed or direction. Even when people are positioned properly, alert your passengers if you must make any unusual maneuver. Always avoid jumping waves or wakes.

EMU33760

**Overloading**

Do not overload the boat. Consult the boat capacity plate or boat manufacturer for maximum weight and number of passengers. Be sure that weight is properly distributed according to the boat manufacturers instructions. Overloading or incorrect weight distribution can compromise the boats handling and lead to an accident, capsizing or swamping.

EMU33770

**Avoid collisions**

**Scan constantly** for people, objects, and other boats. Be alert for conditions that limit your visibility or block your vision of others.

**Operate defensively** at safe speeds and keep a safe distance away from people, objects, and other boats.

- Do not follow directly behind other boats or waterskiers.
- Avoid sharp turns or other maneuvers that make it hard for others to avoid you or understand where you are going.

# Safety information

---

- Avoid areas with submerged objects or shallow water.
- Ride within your limits and avoid aggressive maneuvers to reduce the risk of loss of control, ejection, and collision.
- **Take early action** to avoid collisions. Remember, **boats do not have brakes**, and stopping the engine or reducing throttle can reduce the ability to steer. If you are not sure that you can stop in time before hitting an obstacle, apply throttle and turn in another direction.

EMU33790

## **Weather**

Stay informed about the weather. Check weather forecasts before boating. Avoid boating in hazardous weather.

EMU33880

## **Passenger training**

Make sure at least one other passenger is trained to operate the boat in the event of an emergency.

EMU33890

## **Boating safety publications**

Be informed about boating safety. Additional publications and information can be obtained from many boating organizations.

EMU33600

## **Laws and regulations**

Know the marine laws and regulations where you will be boating- and obey them. Several sets of rules prevail according to geographic location, but all are basically the same as the International Rules of the Road.

# Basic requirements

EMU25540

## Fueling instructions

EWM00010

### **WARNING**

**GASOLINE AND ITS VAPORS ARE HIGHLY FLAMMABLE AND EXPLOSIVE!**

- Do not smoke when refueling, and keep away from sparks, flames, or other sources of ignition.
- Stop engine before refueling.
- Refuel in a well-ventilated area. Refuel portable fuel tanks off the boat.
- Take care not to spill gasoline. If gasoline spills, wipe it up immediately with dry rags.
- Do not overfill the fuel tank.
- Tighten the filler cap securely after refueling.
- If you should swallow some gasoline, inhale a lot of gasoline vapor, or get gasoline in your eyes, get immediate medical attention.
- If any gasoline spills onto your skin, immediately wash with soap and water. Change clothing if gasoline spills on it.
- Touch the fuel nozzle to the filler opening or funnel to help prevent electrostatic sparks.

ECM00010

### **CAUTION:**

Use only new clean gasoline which has been stored in clean containers and is not contaminated with water or foreign matter.

EMU25580

## Gasoline

Recommended gasoline:  
Regular unleaded gasoline with a minimum octane rating of 90 (Research Octane Number).

If knocking or pinging occurs, use a different brand of gasoline or premium unleaded fuel.

EMU25683

## Engine oil

Recommended engine oil:  
4-stroke motor oil with a combination of the following SAE and API oil classifications  
Engine oil type SAE:  
10W-30 or 10W-40  
Engine oil grade API:  
SE, SF, SG, SH, SJ, SL  
Engine oil quantity (excluding oil filter):  
5.2 L (5.50 US qt) (4.58 Imp.qt)

### **NOTE:**

If the recommended engine oil grades are not available, select an alternative from the following chart according to the average temperatures in your area.

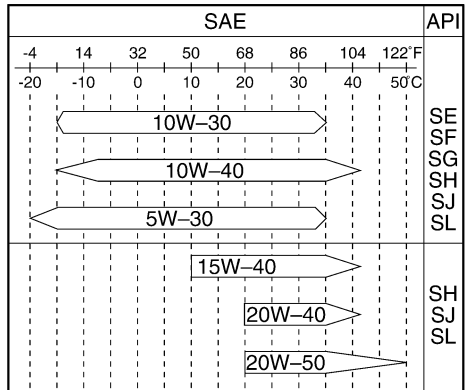

ZMU05190

ECM01050

### **CAUTION:**

**All 4-stroke engines are shipped from the factory without engine oil.**

# Basic requirements

---



ZMU01710

EMU33552

## Installation requirements

EMU33560

### Boat horsepower rating

Before installing the outboard motor(s), confirm that the total horsepower of your motor(s) does not exceed the boat's maximum horsepower rating. See the boat's capacity plate or contact the manufacturer.

EWM01560

### **WARNING**

**Overpowering a boat can cause severe instability.**

---

EMU33570

### Mounting motor

Your dealer or other person experienced in proper rigging should mount the motor using correct equipment and complete rigging instructions. For further information, see page 35.

EWM01570

### **WARNING**

- **Improper mounting of the outboard motor could result in hazardous conditions such as poor handling, loss of control, or fire hazards.**
  - **Because the motor is very heavy, special equipment and training is required to mount it safely.**
- 

EMU33580

### Remote control requirements

The remote control unit must be equipped with a start-in-gear protection device(s). This device prevents the engine from starting unless it is in neutral.

EWM01580

### **WARNING**

- **If the engine starts in gear, the boat can move suddenly and unexpectedly, possibly causing a collision or throwing passengers overboard.**
  - **If the engine ever starts in gear, the start-in-gear protection device is not working correctly and you should discontinue using the outboard. Contact your Yamaha dealer.**
- 

EMU25702

### Battery requirement

ECM01061

### **CAUTION:**

**Do not use a battery that does not meet the specified capacity. If a battery that does not meet specifications is used, the electric system could perform poorly or be overloaded, causing electric system damage.**

---

For electric start models, choose a battery which meets the following specifications.

EMU25721

### Battery specifications

Minimum cold cranking amps (CCA/EN): 711.0 A
Minimum rated capacity (20HR/IEC): 100.0 Ah

The engine cannot be started if battery voltage is too low.



EMU34190

## Propeller selection

Next to selecting an outboard, choosing the right propeller is one of the most important purchasing decisions a boater can make. The type, size, and design of your propeller have a direct impact on acceleration, top speed, fuel economy, and even engine life. Yamaha designs and manufactures propellers for every Yamaha outboard motor and every application.

Your outboard motor came with a Yamaha propeller chosen to perform well over a range of applications, but there may be uses where a different propeller would be more appropriate.

Your Yamaha dealer can help you select the right propeller for your boating needs. Select a propeller that will allow the engine to reach the middle or upper half of the operating range at full throttle with the maximum boat-load. Generally, chose a larger pitch propeller for a smaller operating load and a smaller pitch propeller for a heavier load. If you carry loads that vary widely, chose the propeller that lets the engine run in the proper range for your maximum load but remember that you may need to reduce your throttle setting to stay within the recommended engine speed range when carrying lighter loads.

For instructions on propeller removal and installation, see page 64.

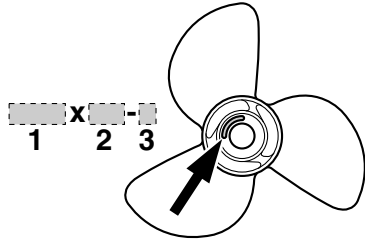

ZMU04607

1. Propeller diameter in inches
2. Propeller pitch in inches
3. Type of propeller (propeller mark)

# Basic components

EMU2579D

## Main components

### NOTE:

\* May not be exactly as shown; also may not be included as standard equipment on all models.

### F150A, FL150A

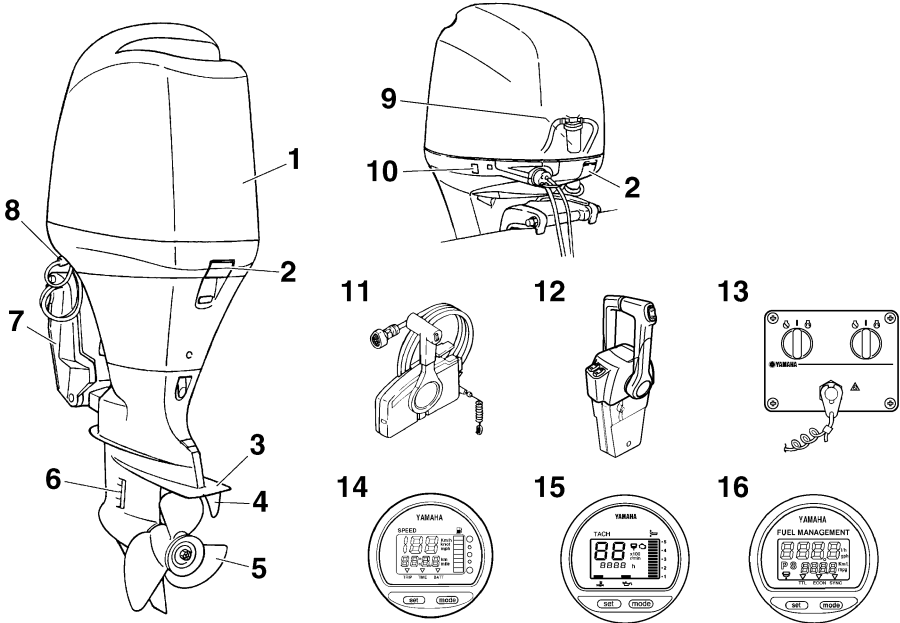

ZMU04742

1. Top cowling
2. Top cowling lock lever(s)
3. Anti-cavitation plate
4. Trim tab (anode)
5. Propeller\*
6. Cooling water inlet
7. Clamp bracket
8. Flushing device
9. Water separator
10. Power trim and tilt switch
11. Remote control box (side mount type)\*
12. Remote control box (binnacle mount type)\*
13. Switch panel (for use with binnacle type)\*
14. Digital speedometer\*
15. Digital tachometer\*
16. Fuel management meter\*

# Basic components

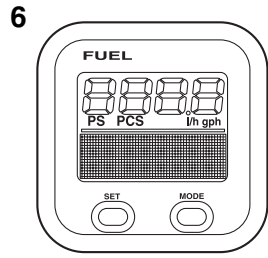
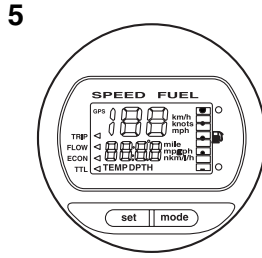
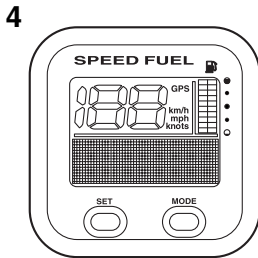
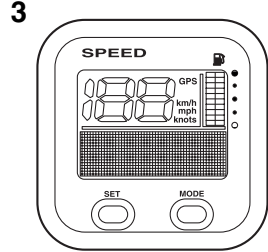
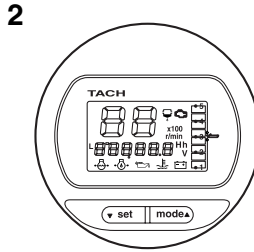
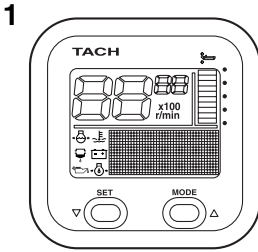

ZMU05429

1. Tachometer unit (Square type)\*
2. Tachometer unit (Round type)\*
3. Speedometer unit (Square type)\*
4. Speed & fuel meter unit (Square type)\*
5. Speed & fuel meter unit (Round type)\*
6. Fuel management meter (Square type)\*

EMU26180

## Remote control

The remote control lever actuates both the shifter and the throttle. The electrical switches are mounted on the remote control box.

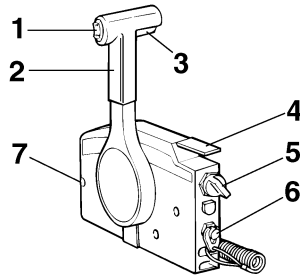

ZMU01723

1. Power trim and tilt switch
2. Remote control lever
3. Neutral interlock trigger
4. Neutral throttle lever
5. Main switch / choke switch
6. Engine shut-off switch
7. Throttle friction adjuster

# Basic components

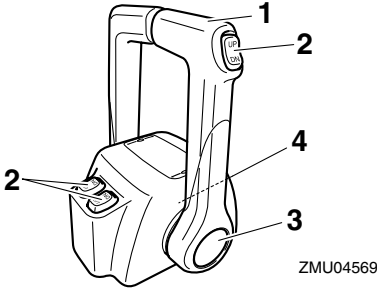

1. Remote control lever
2. Power trim and tilt switch
3. Free accelerator
4. Throttle friction adjuster

EMU26190

## Remote control lever

Moving the lever forward from the neutral position engages forward gear. Pulling the lever back from neutral engages reverse. The engine will continue to run at idle until the lever is moved about 35° (a detent can be felt). Moving the lever farther opens the throttle, and the engine will begin to accelerate.

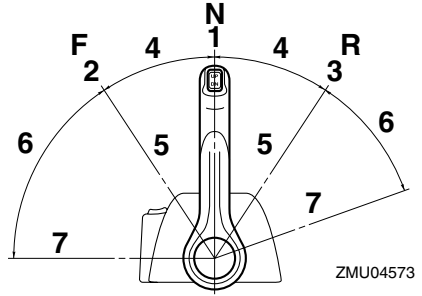

1. Neutral "N"
2. Forward "F"
3. Reverse "R"
4. Shift
5. Fully closed
6. Throttle
7. Fully open

EMU26201

## Neutral interlock trigger

To shift out of neutral, first pull the neutral interlock trigger up.

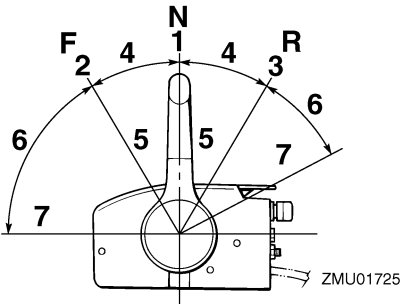

1. Neutral "N"
2. Forward "F"
3. Reverse "R"
4. Shift
5. Fully closed
6. Throttle
7. Fully open

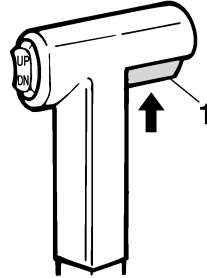

1. Neutral interlock trigger

EMU26211

## Neutral throttle lever

To open the throttle without shifting into either forward or reverse, put the remote control lever in the neutral position and lift the neutral throttle lever.

# Basic components

## NOTE:

The neutral throttle lever will operate only when the remote control lever is in neutral. The remote control lever will operate only when the neutral throttle lever is in the closed position.

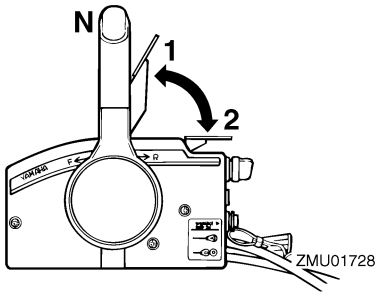

1. Fully open
2. Fully closed

EMU26232

## Free accelerator

To open the throttle without shifting into either forward or reverse, push the free accelerator button and move the remote control lever.

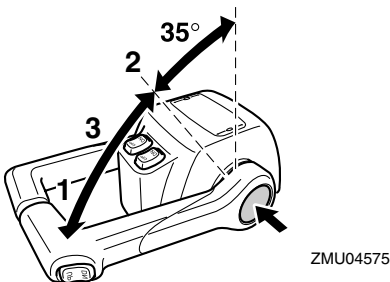

1. Fully open
2. Fully closed
3. Free accelerator

## NOTE:

- The free accelerator button can only be used when the remote control lever is in the neutral position.

- After the button is pushed, the throttle begins to open after the remote control lever is moved at least 35°.
- After using the free accelerator, return the remote control lever to the neutral position. The free accelerator button will return automatically to its set position. The remote control will then engage forward and reverse normally.

EMU25971

## Throttle friction adjuster

A friction device provides adjustable resistance to movement of the throttle grip or the remote control lever, and can be set according to operator preference.

To increase resistance, turn the adjuster clockwise. To decrease resistance, turn the adjuster counterclockwise.

EWM00031

## WARNING

**Do not overtighten the friction adjuster. If there is too much resistance, it could be difficult to move the remote control lever or throttle grip, which could result in an accident.**

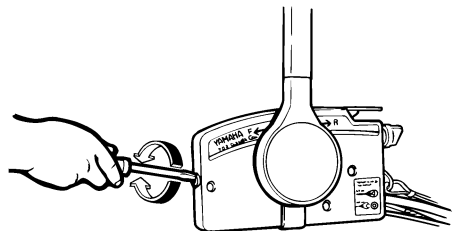

ZMU01714

# Basic components

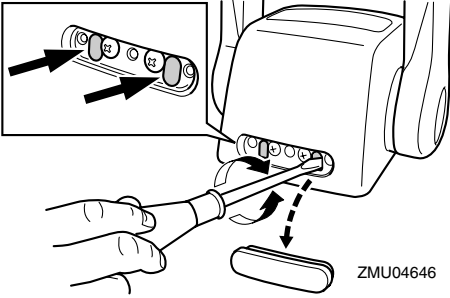

When constant speed is desired, tighten the adjuster to maintain the desired throttle setting.

EMU25991

## Engine shut-off switch

The clip must be attached to the engine shut-off switch for the engine to run. The cord should be attached to a secure place on the operator's clothing, or arm or leg. Should the operator fall overboard or leave the helm, the cord will pull out the clip, stopping ignition to the engine. This will prevent the boat from running away under power.

EWMO0121

### **WARNING**

- Attach the engine shut-off cord to a secure place on your clothing, or your arm or leg while operating.
- Do not attach the cord to clothing that could tear loose. Do not route the cord where it could become entangled, preventing it from functioning.
- Avoid accidentally pulling the cord during normal operation. Loss of engine power means the loss of most steering control. Also, without engine power, the boat could slow rapidly. This could cause people and objects in the boat to be thrown forward.

## NOTE:

The engine cannot be started with the clip removed.

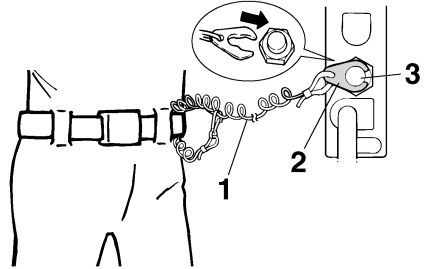

ZMU01716

1. Cord
2. Clip
3. Engine shut-off switch

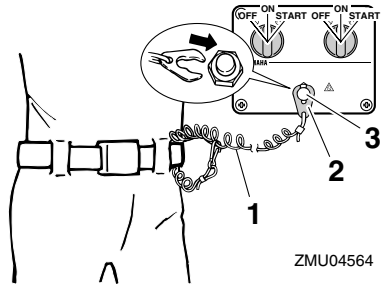

ZMU04564

1. Cord
2. Clip
3. Engine shut-off switch

EMU26090

## Main switch

The main switch controls the ignition system; its operation is described below.

### ● "OFF" (off)

With the main switch in the "OFF" (off) position, the electrical circuits are off, and the key can be removed.

### ● "ON" (on)

With the main switch in the "ON" (on) position, the electrical circuits are on, and the key cannot be removed.

# Basic components

## ● “START” (start)

With the main switch in the “START” (start) position, the starter motor turns to start the engine. When the key is released, it returns automatically to the “ON” (on) position.

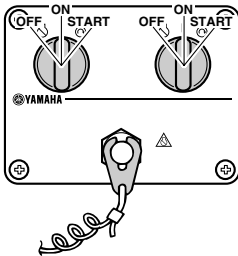
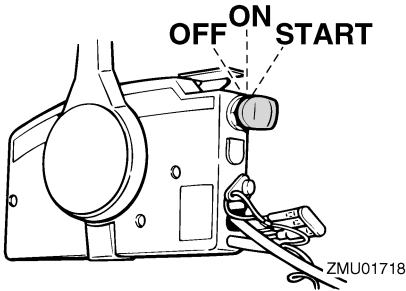

EMU32051

## Power trim and tilt switch on remote control

The power trim and tilt system adjusts the outboard motor angle in relation to the transom. Pressing the switch “UP” (up) trims the outboard motor up, and then tilts it up. Pressing the switch “DN” (down) tilts the outboard motor down and trims it down. When the switch is released, the outboard motor will stop in its current position.

### NOTE:

For instructions on using the power trim and tilt switch, see pages 43 and 45.

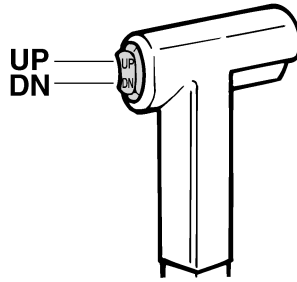

EMU26152

## Power trim and tilt switch on bottom engine cowling

The power trim and tilt switch is located on the side of the bottom engine cowling. Pressing the switch “UP” (up) trims the outboard motor up, and then tilts it up. Pressing the switch “DN” (down) tilts the outboard motor down and trims it down. When the switch is released, the outboard motor will stop in its current position.

EWM01030

### **WARNING**

Use the power trim and tilt switch located on the bottom engine cowling only when the boat is at a complete stop with the engine off. Attempting to use this switch while the boat is moving could increase the risk of falling overboard and could distract the operator, increasing the risk of collision with another boat or an obstacle.

# Basic components

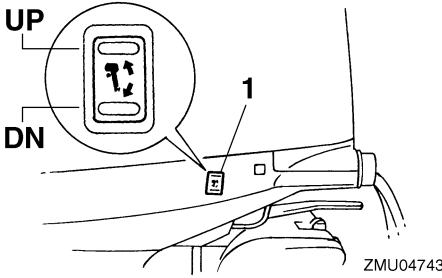

1. Power trim and tilt switch

## NOTE:

For instructions on using the power trim and tilt switch, see page 45.

EMU26162

## Power trim and tilt switches (twin binnacle type)

The power trim and tilt system adjusts the outboard motor angle in relation to the transom. Pushing the switch “UP” (up) trims the outboard motor up, and then tilts it up. Pressing the switch “DN” (down) tilts the outboard motor down and trims it down. When the switch is released, the outboard motor will stop in its current position.

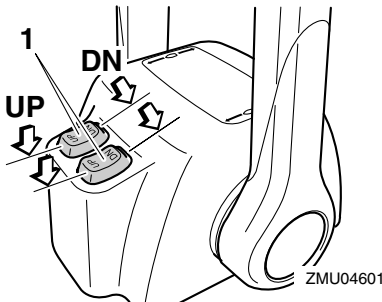

1. Power trim and tilt switch

## NOTE:

- On the dual engine control, the switch on the remote control grip controls both outboard motors at the same time.

- For instructions on using the power trim and tilt switches, see pages 43 and 45.

EMU26243

## Trim tab with anode

The trim tab should be adjusted so that the steering control can be turned to either the right or left by applying the same amount of force.

EWM00840



**An improperly adjusted trim tab could cause difficult steering. Always test run after the trim tab has been installed or replaced to be sure steering is correct. Be sure you have tightened the bolt after adjusting the trim tab.**

If the boat tends to veer to the left (port side), turn the trim tab rear end to the port side “A” in the figure. If the boat tends to veer to the right (starboard side), turn the trim tab end to the starboard side “B” in the figure.

ECM00840

## CAUTION:

**The trim tab also serves as an anode to protect the engine from electrochemical corrosion. Never paint the trim tab as it will become ineffective as an anode.**



# Basic components

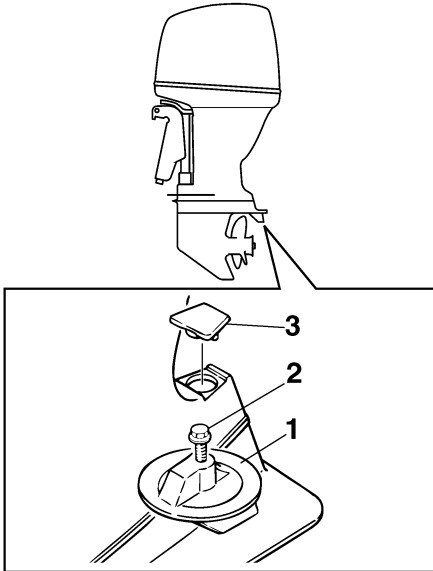

ZMU01730

1. Trim tab
2. Bolt
3. Cap

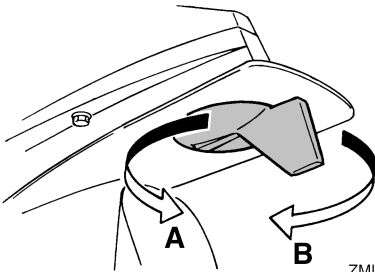

ZMU01731

Bolt tightening torque:  
42.0 Nm (31.0 ft-lb) (4.28 kgf-m)

EMU26341

## Tilt support lever for power trim and tilt model

To keep the outboard motor in the tilted up position, lock the tilt support lever to the clamp bracket.

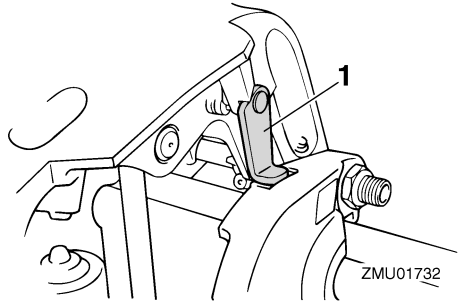

1. Tilt support lever

ECM00660

## CAUTION:

**Do not use the tilt support lever or knob when trailering the boat. The outboard motor could shake loose from the tilt support and fall. If the motor cannot be trailered in the normal running position, use an additional support device to secure it in the tilt position.**

EMU26382

## Top cowling lock lever (pull up type)

To remove the engine top cowling, pull up the lock lever(s) and lift off the cowling. When installing the cowling, check to be sure it fits properly in the rubber seal. Then lock the cowling by moving the lever(s) downward.

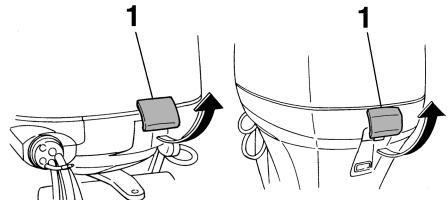

ZMU04744

1. Top cowling lock lever(s)

# Basic components

EMU26460

## Flushing device

This device is used to clean the cooling water passages of the motor using a garden hose and tap water.

**NOTE:** \_\_\_\_\_

For details on usage, see page 53.

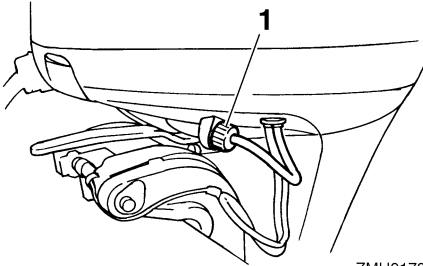

ZMU01734

1. Flushing device

EMU31704

## Fuel filter/Water separator

This engine has a combination fuel filter/water separator and associated warning system. If water separated from the fuel exceeds a specific volume, the warning device of the Command Link Tachometer will activate.

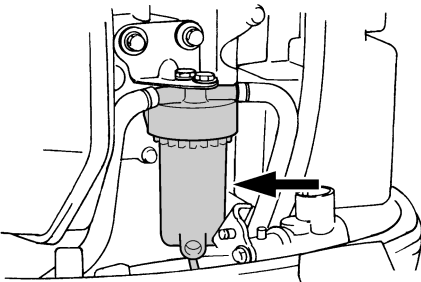

ZMU05493

### Activation of warning device

- The water separator-warning indicator of the Command Link Tachometer will blink.
- The buzzer will sound intermittently only when the gear shift is in neutral.

- If the warning system has activated, stop the engine and consult a Yamaha dealer immediately.

EMU31411

## Digital tachometer

The tachometer shows the engine speed and has the following functions.

**NOTE:** \_\_\_\_\_

All segments of the display will light momentarily after the main switch is turned on and will return to normal thereafter.

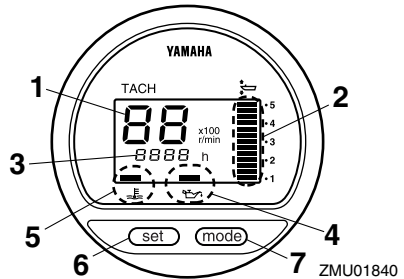

ZMU01840

1. Tachometer
2. Trim meter
3. Hour meter
4. Low oil pressure-warning indicator
5. Overheat-warning indicator
6. Set button
7. Mode button

**NOTE:** \_\_\_\_\_

The water separator-warning indicator and engine trouble-warning indicator on the digital tachometer do not operate for this engine.

EMU26523

## Low oil pressure-warning indicator

If oil pressure drops too low, the warning indicator will start to blink. For further information, see page 33.

# Basic components

ECM00021

## CAUTION:

- Do not continue to run the engine if the low oil pressure-warning indicator is on and the engine oil level is lower. Serious engine damage will occur.
- The low oil pressure-warning indicator does not indicate the engine oil level. Use the oil dipstick to check the remaining oil quantity. For further information, see page 37.

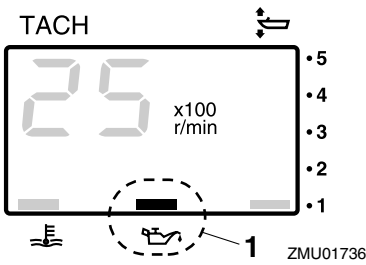

1. Low oil pressure-warning indicator

EMU26582

## Overheat-warning indicator (digital type)

If the engine temperature rises too high, the warning indicator will start to blink. For further information on reading the indicator, see page 33.

ECM00051

## CAUTION:

Do not continue to run the engine if the overheat-warning indicator is on. Serious engine damage will occur.

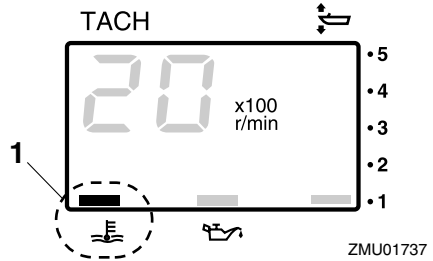

1. Overheat-warning indicator

EMU26601

## Speedometer (digital type)

This gauge shows the boat speed.

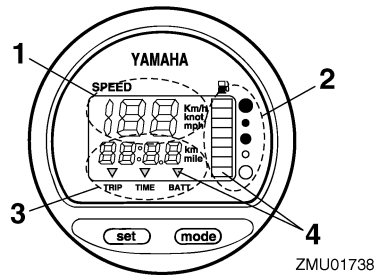

1. Speedometer  
2. Fuel gauge  
3. Trip meter/clock/voltmeter  
4. Warning indicator(s)

## NOTE:

After the main switch is first turned on, all segments of the display come on as a test. After a few seconds, the gauge will change to normal operation. Watch the gauge when turning on the main switch to make sure all segments come on.

# Basic components

**NOTE:** \_\_\_\_\_

The speedometer displays km/h, mph, or knots, according to operator preference. Select the desired units of measurement by setting the selector switch on the back of the gauge. See the illustration for settings.

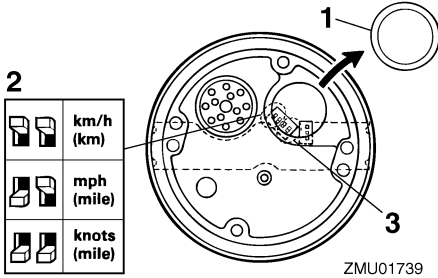

ZMU01739

1. Cap
2. Selector switch (for speed unit)
3. Selector switch (for fuel sensor)

EMU26620

## Trim meter (digital type)

This meter shows the trim angle of your outboard motor.

**NOTE:** \_\_\_\_\_

- Memorize the trim angles that work best for your boat under different conditions. Adjust the trim angle to the desired using the power trim and tilt switch.
- If the trim angle of your motor exceeds the trim operating range, the top segment on the trim meter display will blink.

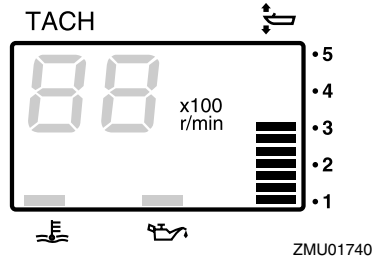

ZMU01740

EMU26650

## Hour meter (digital type)

This meter shows the number of hours the engine has been run. It can be set to show the total number of hours or the number of hours for the current trip. The display can also be turned on and off.

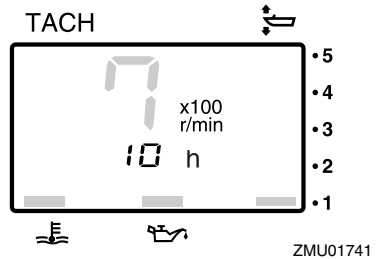

ZMU01741

- Changing the display format  
Pressing the “mode” (mode) button changes the display format in the following pattern:  
Total hours→Trip hours→Display off
- Resetting the trip hours  
Simultaneously pressing the “set” (set) and “mode” (mode) buttons for more than 1 second while the trip hours are displayed resets the trip counter to 0 (zero).

**NOTE:** \_\_\_\_\_

The total number of hours the engine has been run cannot be reset.

# Basic components

EMU26690

## Trip meter

This gauge displays the distance the boat has traveled since the gauge was last reset.

Press the “mode” (mode) button repeatedly until the indicator on the face of the gauge points to “TRIP” (trip). To reset the trip meter to zero, press the “set” (set) and “mode” (mode) buttons at the same time.

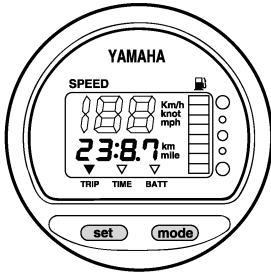

ZMU01743

### NOTE:

- The trip distance is shown in kilometers or miles depending upon the unit of measurement selected for the speedometer.
- The trip distance is kept in memory by battery power. The stored data will be lost if the battery is disconnected.

EMU26700

## Clock

Press the “mode” (mode) button repeatedly until the indicator on the face of the gauge points to “TIME” (time). To set the clock, be sure the gauge is in the “TIME” (time) mode. Press the “set” (set) button; the hour display will begin blinking. Press the “mode” (mode) button until the desired hour is displayed. Press the “set” (set) button again, the minute display will begin blinking. Press the “mode” (mode) button until the desired minute is displayed. Press the “set” (set) button again to start the clock.

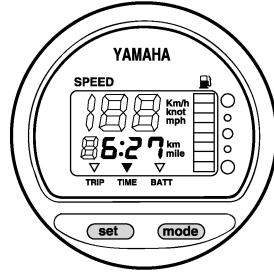

ZMU01744

### NOTE:

The clock operates on battery power. Disconnecting the battery will stop the clock. Reset the clock after connecting the battery.

EMU26711

## Fuel gauge

Eight segments indicate the fuel level. When all segments are showing, the fuel tank is full.

ECM00860

### CAUTION:

**The Yamaha fuel tank sensor differs from conventional sensors. Incorrectly setting the selector switch on the gauge will give false readings. Consult your Yamaha dealer on how to correctly set the selector switch.**

### NOTE:

The fuel level reading can be affected by the position of the sensor in the fuel tank and the attitude of the boat in the water. Operation with bow-up trim or continuous turning can give false readings.

# Basic components

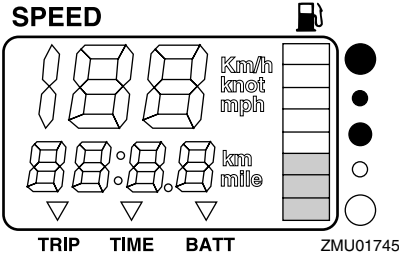

EMU26720

## Fuel warning indicator

If the fuel level decreases to one segment, the fuel level warning segment will begin to blink.

ECM00880

### CAUTION:

**Do not continue to operate the engine with full throttle if a warning device has activated. Get back to the port within trolling engine speed.**

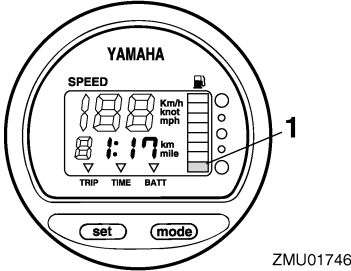

1. Fuel level warning segment

EMU26731

## Low battery voltage-warning indicator

If battery voltage drops, the display will automatically turn on and begin to blink.

ECM00870

### CAUTION:

**Get back to the port soon if a warning device has activated. For charging the battery, consult your Yamaha dealer.**

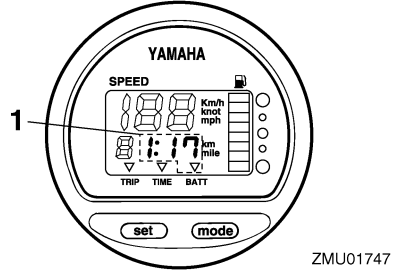

1. Low battery indicator

EMU26740

## Fuel management meter

The fuel management meter shows the state of the fuel consumption while the engine is running.

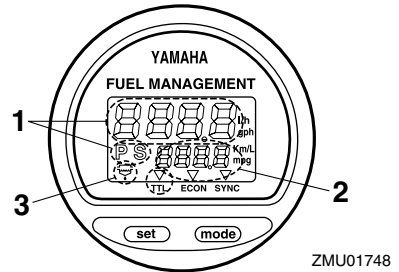

1. Fuel flow meter
2. Fuel consumption meter / Fuel economy meter / Twin engine speed synchronizer
3. Water separator-warning indicator (operates only if the sensor has been installed)

### NOTE:

After the main switch is first turned on, all segments of the display come on as a test. After a few seconds, the gauge will change to normal operation. Watch the gauge when turning on the main switch to make sure all segments come on.

# Basic components

EMU26751

## Fuel flow meter

The fuel flow meter displays the amount of fuel flow over a one-hour period, at the current rate of engine operation.

Fuel flow readings are not accurate when the engine is operating under about 1300 r/min. As the fuel pump cycles on and off, the display indicates either no fuel flow or higher flow than the actual average use.

If twin engines are installed on your boat, the fuel flow meter displays the total fuel flow of both the port and starboard engines. It also displays “P S” (for port and starboard).

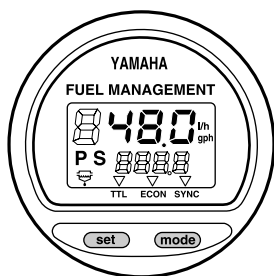

ZMU01749

Use the “set” (set) button to rotate the fuel flow display in the following order:

- Press the “set” (set) button once to display the fuel flow of the starboard engine. An “S” (for starboard) will also be displayed.
- Press the “set” (set) button a second time to display the fuel flow of the port engine. A “P” (for port) will also be displayed.
- Press the “set” (set) button a third time to return the display to the total fuel flow of both engines. “P S” (for port and starboard) will also be displayed to indicate both the port and starboard engines.

## NOTE:

- The fuel flow meter displays gallons/hour or liters/hour according to operator preference. Select the desired units of measurement by setting the selector switch on the back of the gauge during installation.

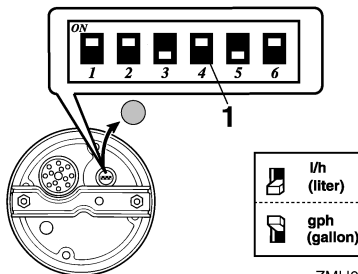

ZMU01750

1. Selector switch

- The fuel consumption meter and fuel economy meter will indicate the same unit of measurement.

EMU26760

## Fuel consumption meter

This gauge displays the total amount of fuel consumed since the gauge was last reset.

Press the “mode” (mode) button repeatedly until the indicator on the face of the gauge points to total “TTL” (total). To reset the total fuel consumption to zero, press the “set” (set) and “mode” (mode) buttons at the same time.

## FUEL MANAGEMENT

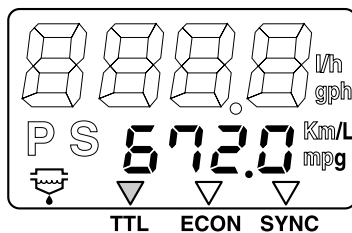

ZMU01751

# Basic components

EMU26770

## Fuel economy

This gauge displays the distance per liter or gallon when cruising, and is only for reference use by the operator.

Press the “mode” (mode) button repeatedly until the indicator on the face of the gauge points to “ECON” (economy).

## FUEL MANAGEMENT

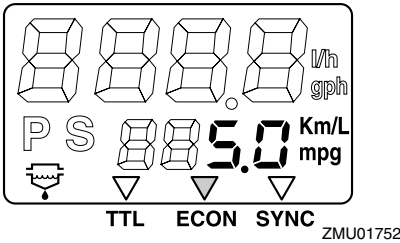

### NOTE:

If twin engines are installed on your boat, the gauge will only display the total fuel economy of both engines.

### NOTE:

- Fuel consumption varies greatly with boat design, weight, propeller used, engine trim angle, sea conditions (including wind), and throttle position. Fuel consumption also varies slightly with the type of water (salt, fresh, and contaminate levels), air temperature and humidity, cleanliness of the boat bottom, engine mounting height, skill of the operator, and individual gasoline formulation (winter or summer fuel and amount of additives).
- The Yamaha digital speedometer and fuel management meter calculates speed, miles traveled, and fuel economy by water movement at the stern of the boat. This distance can vary greatly from the actual distance traveled because of water currents,

sea swells, and the condition of the water speed sensor (partially plugged or damaged).

- Individual engines may slightly vary in their fuel consumption due to manufacturing variations. These variations can be even greater if the engines are of different year models. In addition, variations in propellers, even of the same basic dimensions of the same design, can also cause a slight variation in fuel consumption.

EMU26781

## Twin-engine speed synchronizer

This gauge displays the difference in engine speed (r/min) between the port and starboard engines for reference purposes when synchronizing the two engines' speeds.

Press the “mode” (mode) button repeatedly until the indicator on the face of the gauge points to “SYNC” (synchronizer).

## FUEL MANAGEMENT

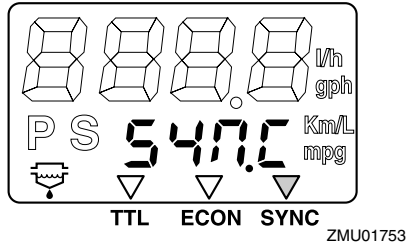

### FUEL MANAGEMENT

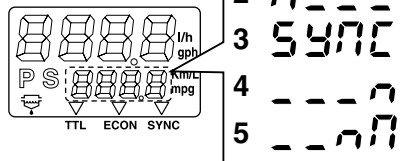

ZMU01754

- Port engine speed is higher



# Basic components

2. Port engine speed is slightly higher
3. Engine speed is synchronized evenly between port and starboard engines
4. Starboard engine speed is slightly higher
5. Starboard engine speed is higher

**NOTE:** \_\_\_\_\_

If the two engines' speeds are not synchronized while cruising, adjusting trim angle or throttle can synchronize them.

EMU26792

**Water separator-warning indicator**

This indicator will blink when water has accumulated in the water separator. In such an event, stop the engine and drain the water from the separator.

**NOTE:** \_\_\_\_\_

This indicator only operates when a water separator sensor is equipped.

## FUEL MANAGEMENT

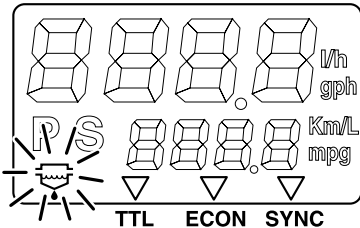

EMU31652

**6Y8 Multifunction meters**

Multifunction meters have 6 kinds of meter units; tachometer unit (square or round types), speedometer unit (square type), speed & fuel meter unit (square or round types), and fuel management meter (square type). The indicator system is slightly different between the round and square types. Check the model and type of your unit carefully. This manual describes mainly the warning indica-

tors. For more details on setting meters or changing indicator systems, see the operation manual included with the meter.

EMU32560

**Tachometer unit**

The tachometer shows the engine revolutions per minute. It has functions of trim meter, adjusting trolling speed, cooling water/engine temperature display, battery voltage display, total hour/trip hour display, oil pressure display, water detection warning, engine trouble warning, and periodic maintenance notification. If optional sensors are connected to the unit, cooling water pressure display will be available. For the optional sensor, consult your Yamaha dealer. The tachometer unit is available in round or square types. Check your tachometer unit type.

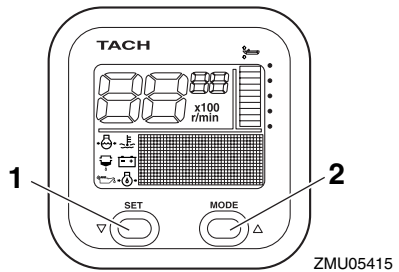

1. Set button
2. Mode button

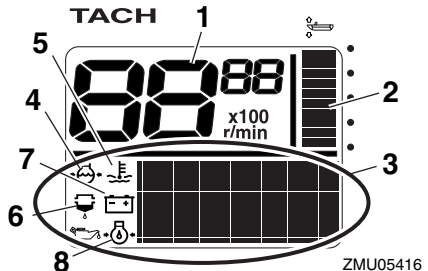

1. Tachometer
2. Trim meter

# Basic components

3. Multifunction display
4. Cooling water pressure
5. Cooling water/engine temperature
6. Water detection warning indicator
7. Battery voltage
8. Oil pressure (4-stroke models)

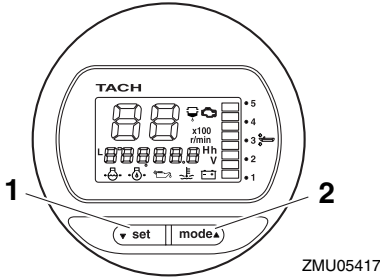

1. Set button
2. Mode button

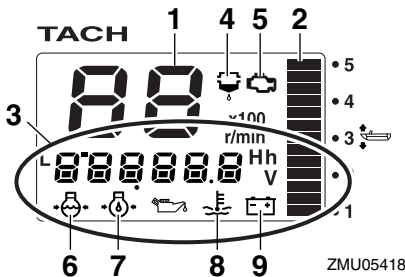

1. Tachometer
2. Trim meter
3. Multifunction display
4. Water detection warning indicator
5. Engine trouble warning/maintenance indicator
6. Cooling water pressure
7. Oil pressure (4-stroke models)
8. Cooling water/engine temperature
9. Battery voltage

**NOTE:** \_\_\_\_\_  
 The tachometer unit shows various kinds of information according to the setting made using the “set” (set) and “mode” (mode) buttons. For details, see the attached operation manual.

**Pre-operation checks**  
 Place the remote control lever in neutral and turn the main switch to “ON” (on). After all the displays come on and the total hour display comes on, the gauge will change to normal operation. If the buzzer sounds and the water separator-warning indicator blinks, consult your Yamaha dealer immediately.

**NOTE:** \_\_\_\_\_  
 To stop the buzzer, press the “set” (set) or “mode” (mode) button.

**Low oil pressure warning**  
 When the engine oil pressure drops too low, the low oil pressure-warning indicator will start to blink, and the engine speed will automatically decrease to about 2000 r/min.

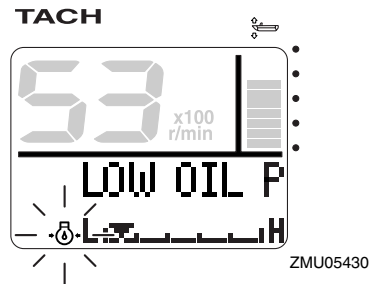

## TACH

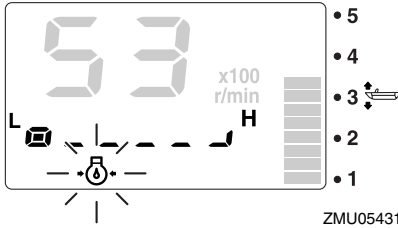

Stop the engine immediately if the buzzer sounds and the low oil pressure-warning indicator blinks. Check the engine oil quantity and replenish oil if necessary. If the warning device has activated while the appropriate engine oil quantity is maintained, consult your Yamaha dealer.

ECM01600

### CAUTION:

**Do not continue to run the engine if the low oil pressure warning device has activated. Serious engine damage will occur.**

### Overheat warning

If the engine temperature rises too high while cruising, the overheat-warning indicator will start to blink. The engine speed will automatically decrease to about 2000 r/min.

## TACH

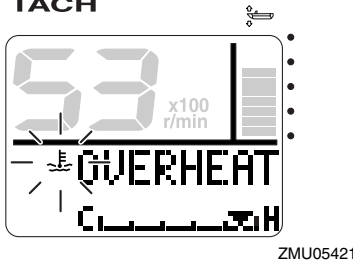

## TACH

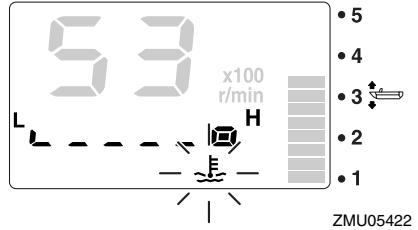

Stop the engine immediately if the buzzer sounds and the overheat warning device has activated. Check the cooling water inlet for clogging.

ECM01591

### CAUTION:

- Do not continue to run the engine if the overheat-warning indicator blinks. Serious engine damage will occur.
- Do not continue to operate the engine if a warning device has activated. Consult your Yamaha dealer if the problem cannot be located and corrected.

### Water separator warning

This indicator will blink when water has accumulated in the water separator (fuel filter) while cruising. In such an event, stop the engine immediately and see page 74 of this manual to drain the water from the fuel filter. Get back to the port soon and consult a Yamaha dealer immediately.

## TACH

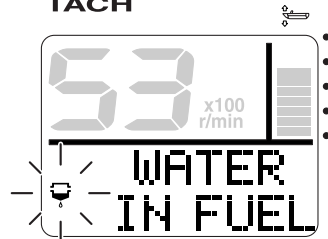

ZMU05423

# Basic components

## TACH

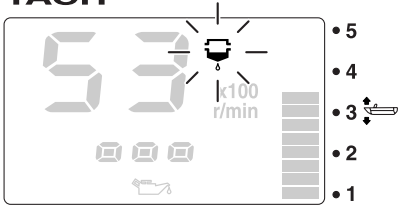

ZMU05424

ECM00910

### CAUTION:

**Gasoline mixed with water could cause damage to the engine.**

### Engine trouble warning

This indicator will blink when the engine malfunctions while cruising. Get back to the port soon and consult a Yamaha dealer immediately.

## TACH

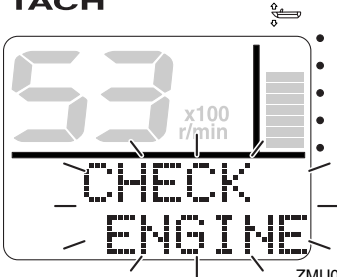

ZMU05425

## TACH

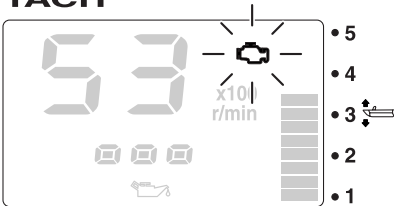

ZMU05426

ECM00920

### CAUTION:

**In such an event, the engine will not operate properly. Consult a Yamaha dealer immediately.**

### Low battery voltage warning

When the battery voltage drops, the low battery voltage-warning indicator and the battery voltage value will start to blink. Get back to the port soon if the low battery voltage-warning device has activated. For charging the battery, consult your Yamaha dealer.

## TACH

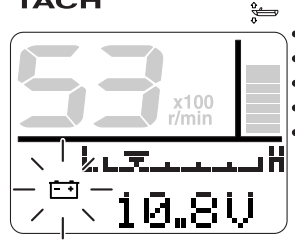

ZMU05427

## TACH

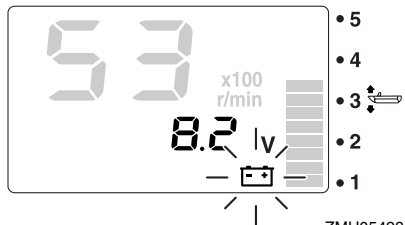

ZMU05428

EMU31610

### Speed & fuel meter unit

This unit shows the boat speed and has the functions of fuel meter, total fuel consumption display, fuel economy display, fuel flow display, and system voltage display. If optional sensors are connected to the unit, trip display, water surface temperature display, depth display, and clock will be available. For the op-

# Basic components

tional sensor, consult your Yamaha dealer. The speed & fuel meter unit is available in round or square types. Check your speed & fuel meter unit type.

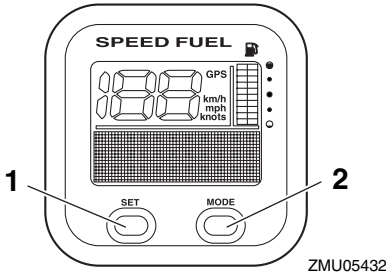

1. Set button
2. Mode button

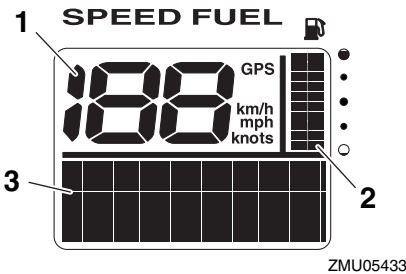

1. Speedometer
2. Fuel meter
3. Multifunction display

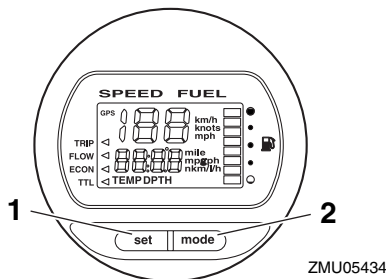

1. Set button
2. Mode button

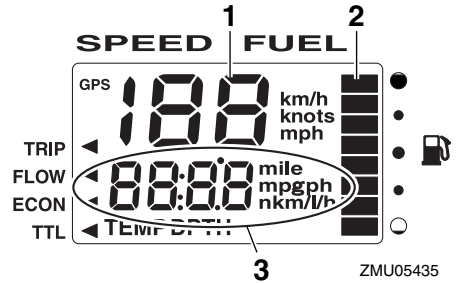

1. Speedometer
2. Fuel meter
3. Multifunction display

**NOTE:** \_\_\_\_\_  
After the main switch is first turned on, all the displays come on as a test. After a few seconds, the gauge will change to normal operation.

**NOTE:** \_\_\_\_\_  
The speed & fuel meter unit shows various kinds of information according to the setting made with the “set” (set) and “mode” (mode) buttons. For details, see the attached operation manual.

EMU31620

## Speedometer unit

This unit shows the boat speed and has functions of fuel meter and system voltage display. If optional sensors are connected to the unit, trip display, water surface temperature display, depth display, and clock will be available. For the optional sensor, consult your Yamaha dealer.

# Basic components

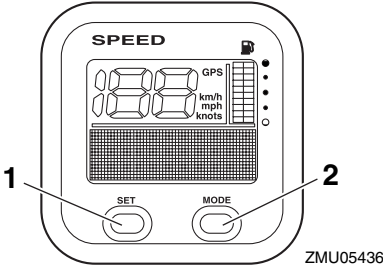

1. Set button
2. Mode button

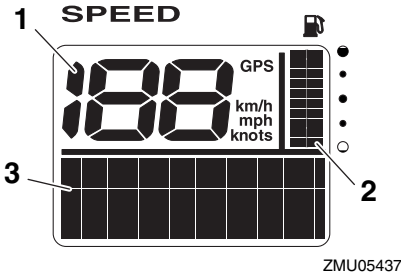

1. Speedometer
2. Fuel meter
3. Multifunction display

**NOTE:** After the main switch is first turned on, all the displays come on as a test. After a few seconds, the gauge will change to normal operation.

**NOTE:** The speedometer unit shows various kinds of information according to the setting made using the “set” (set) and “mode” (mode) buttons. In addition, the speedometer can show the desired unit of measurement such as km/h, mph, or knots. For details, see the attached operation manual.

EMU31631

## Fuel management meter

This meter has functions of fuel flow meter, total consumption display, fuel economy display, and remaining fuel display.

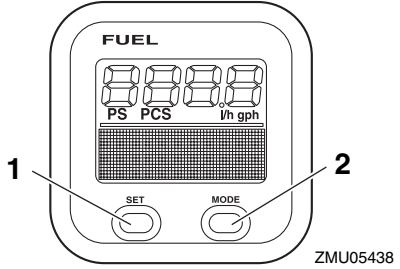

1. Set button
2. Mode button

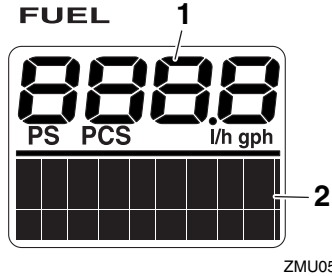

1. Fuel flow meter
2. Multifunction display

**NOTE:** After the main switch is first turned on, all the displays come on as a test. After a few seconds, the gauge will change to normal operation.

**NOTE:** The fuel management meter shows various kinds of information when the operator uses the “set” (set) and “mode” (mode) buttons. For details, see the operation manual included with the meter.

EMU26802

## Warning system

ECM00090

### CAUTION:

Do not continue to operate the engine if a warning device has activated. Consult your Yamaha dealer if the problem cannot be located and corrected.

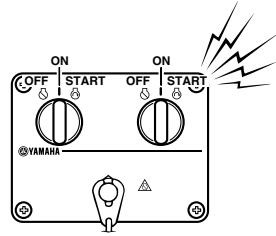

ZMU04584

EMU26825

### Overheat warning

This engine has the overheat warning device. If the engine temperature rises too high, the warning device will activate.

Activation of warning device

- The engine speed will automatically decrease to about 2000 r/min.
- If equipped with the overheat-warning indicator, it will light or blink.

If the warning system has activated, stop the engine and check the cooling water inlet for clogging.

### NOTE:

Dual engine drive users:

Should the overheat-warning system of one engine activate, the engine will slow down and the buzzer will sound. This will cause the other engine to slow down and the buzzer to sound. To switch off the warning activation on the engine not affected by overheating, turn off the main switch of the engine overheating.

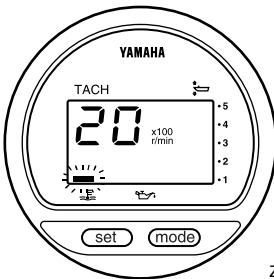

ZMU01757

- The buzzer will sound.

EMU26856

### Low oil pressure warning

If the oil pressure drops too low, the warning device will activate.

Activation of warning device

- The engine speed will automatically decrease to about 2000 r/min.
- The low oil pressure-warning indicator will light or blink.

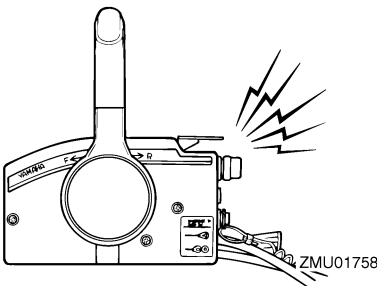

ZMU01758

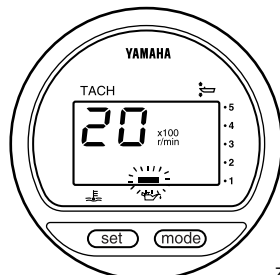

ZMU01828

# Basic components

---

- The buzzer will sound.

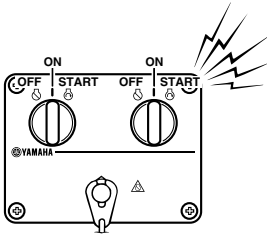
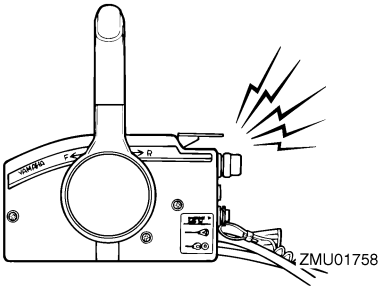

ZMU04584

If the warning system has activated, stop the engine as soon as it is safe to do so. Check the oil level and add oil as needed. If the oil level is correct and the warning device does not switch off, consult your Yamaha dealer.

ECM00101

## **CAUTION:**

**Do not continue to run the engine if the low oil pressure-warning indicator is on. Serious engine damage could occur.**

---



EMU26902

## Installation

The information presented in this section is intended as reference only. It is not possible to provide complete instructions for every possible boat and motor combination. Proper mounting depends in part on experience and the specific boat and motor combination.

EWM01590

### **WARNING**

- **Overpowering a boat could cause severe instability. Do not install an outboard motor with more horsepower than the maximum rating on the capacity plate of the boat. If the boat does not have a capacity plate, consult the boat manufacturer.**
- **Improper mounting of the outboard motor could result in hazardous conditions such as poor handling, loss of control, or fire hazards. For permanently mounted models, your dealer or other person experienced in proper rigging should mount the motor.**

EMU33481

### **Mounting the outboard motor**

The outboard motor should be mounted so that the boat is well balanced. Otherwise, the boat could be hard to steer. For single-engine boats, mount the outboard motor on the centerline (keel line) of the boat. For twin engine boats, mount the outboard motors equidistant from the centerline. Consult your Yamaha dealer or boat manufacturer for further information on determining the proper mounting location.

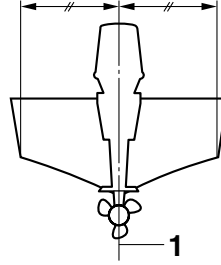

ZMU01760

1. Center line (keel line)

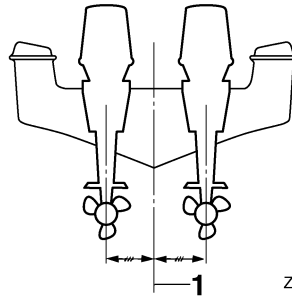

ZMU05141

1. Center line (keel line)

EMU26931

### **Mounting height (boat bottom)**

The mounting height of your outboard motor affects its efficiency and reliability. If it is mounted too high, propeller ventilation may occur, which will reduce propulsion due to excessive propeller slip, and the water intakes for the cooling system may not get adequate water supply, which can cause engine overheating. If the engine is mounted too low, water resistance (drag) will increase, thereby reducing engine efficiency and performance. Most commonly, outboard motor should be mounted so that the anti-cavitation plate is in alignment with the bottom of the boat. The optimum mounting height of the outboard motor is affected by the boat/motor combination and the desired use. Test runs at different heights can help determine the optimum mounting

# Operation

---

height. Consult your Yamaha dealer or boat manufacturer for further information on determining the proper mounting height.

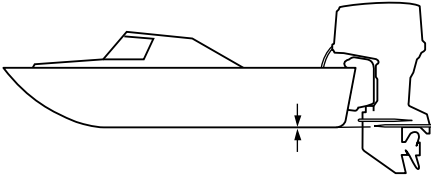

ZMU01762

ECM01630

## CAUTION:

- During water testing, check the buoyancy of the boat, at rest, with its maximum load. Check that the static water level on the exhaust housing is low enough to prevent water entry into the power head when water rises due to waves when the outboard is not running.
  - Incorrect engine height or obstructions to the smooth flow of water (such as the design or condition of the boat, or accessories such as transom ladders or depth finder transducers) can create airborne water spray while the boat is cruising. If the motor is operated continuously in the presence of airborne water spray, enough water could enter the engine through the intake opening on the cowling to cause severe engine damage. Eliminate the cause of the airborne water spray.
- 

EMU30173

## Breaking in engine

Your new engine requires a period of break-in to allow mating surfaces of moving parts to wear in evenly. Correct break-in will help ensure proper performance and longer engine life.

ECM00800

## CAUTION:

**Failure to follow the break-in procedure could result in reduced engine life or even severe engine damage.**

---

EMU27083

## Procedure for 4-stroke models

Your new engine requires a period of ten-hours break-in to allow mating surfaces of moving parts to wear in evenly. Correct break-in will help ensure proper performance and longer engine life.

## NOTE:

Failure to follow the break-in procedure could result in reduced engine life or even severe engine damage. Run the engine in the water, under load (in gear with a propeller installed) as follows. For ten hours for breaking in engine avoid extended idling, rough water and crowded areas.

---

1. For the first hour of operation:  
Run the engine at varying speeds up to 2000 r/min or approximately half throttle.
2. For the second hour of operation:  
Increase engine speed as much as necessary to put the boat on plane (but avoid full-throttle operation), then back off on the throttle while keeping the boat at a planing speed.
3. Remaining eight hours:  
Run the engine at any speed. However, avoid operating at full throttle for more than 5 minutes at a time.

4. After the first 10 hours:  
Operate the engine normally.

EMU27104

## Pre-operation checks

EWM00081

### **WARNING**

If any item in the pre-operation check is not working properly, have it inspected and repaired before operating the outboard motor. Otherwise an accident could occur.

ECM00120

### **CAUTION:**

Do not start the engine out of water. Overheating and serious engine damage can occur.

EMU32490

## Fuel

- Check to be sure you have plenty of fuel for your trip.
- Make sure there are no fuel leaks or gasoline fumes.
- Check fuel line connections to be sure they are tight (if equipped Yamaha fuel tank or boat tank).
- Be sure the fuel tank is positioned on a secure, flat surface, and that the fuel line is not twisted or flattened, or likely to contact sharp objects (if equipped Yamaha fuel tank or boat tank).
- Check the water in the fuel filter with the water separator warning device. Place the remote control lever in neutral and turn the main switch to "ON"(on). If the buzzer sounds and the water separator-warning indicator blinks, consult your Yamaha dealer immediately.

EMU31710

## Controls

- Check throttle, shift, and steering for proper operation before starting the engine.

- The controls should work smoothly, without binding or unusual free play.
- Look for loose or damaged connections.

EMU31721

## Stop switches

- Confirm that turning the main switch to the "OFF" (off) position stops the engine.
- Confirm that removing the clip from the engine shut-off switch stops the engine.
- Confirm that the engine cannot be started with the clip removed from the engine shut-off switch.

EMU27150

## Engine

- Check the engine and engine mounting.
- Look for loose or damaged fasteners.
- Check the propeller for damage.
- Check that the battery is in good condition and the battery connections are secure.

EMU27163

## Checking the engine oil level

1. Put the outboard motor in an upright position (not tilted).
2. Remove oil dipstick and wipe it clean.
3. Completely insert the dipstick and remove it again.
4. Check the oil level using the dipstick to be sure the level falls between the upper and lower marks. Fill with oil if it is below the lower mark, or drain to the specified level if it is above the upper mark.

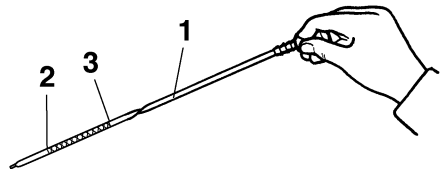

ZMU01822

1. Oil dipstick
2. Lower level mark

# Operation

---

3. Upper level mark

## NOTE:

Be sure to completely insert the dipstick into the dipstick guide.

---

EMU30021

## Filling fuel

EWM00060

### **WARNING**

Gasoline and its vapors are highly flammable and explosive. Keep away from sparks, cigarettes, flames, or other sources of ignition.

---

1. Remove the fuel tank cap.
2. Carefully fill the fuel tank.
3. Securely close the cap after filling the tank. Wipe up any spilled fuel.

EMU27450

## Operating engine

EMU27482

### Feeding fuel

EWM00420

### **WARNING**

- Before starting the engine, make sure that the boat is tightly moored and that you can steer clear of any obstructions. Be sure there are no swimmers in the water near you.
- When the air vent screw is loosened, gasoline vapor will be released. Gasoline is highly flammable, and its vapors are flammable and explosive. Refrain from smoking, and keep away from open flames and sparks while loosening the air vent screw.
- This product emits exhaust gases which contain carbon monoxide, a colorless, odorless gas which could cause brain damage or death when inhaled. Symptoms include nausea, dizziness, and

drowsiness. Keep cockpit and cabin areas well ventilated. Avoid blocking exhaust outlets.

---

1. If there is an air vent screw on the fuel tank cap, loosen it 2 or 3 turns.
2. If there is a fuel joint or a fuel cock on the boat, firmly connect the fuel line to the joint or open the fuel cock.
3. Squeeze the primer pump, with the arrow pointing up, until you feel it become firm.

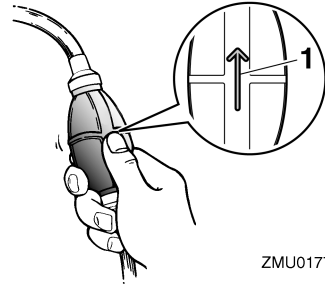

ZMU01770

1. Arrow

EMU27491

### Starting engine

EWM01600

### **WARNING**

Before starting the engine, make sure that the boat is tightly moored and that you can steer clear of any obstructions. Be sure there are no swimmers in the water near you.

---

EMU27625

### Electric start and remote control models

1. Place the remote control lever in "N" (neutral).

## NOTE:

The start-in-gear protection device prevents the engine from starting except when in neutral.

---

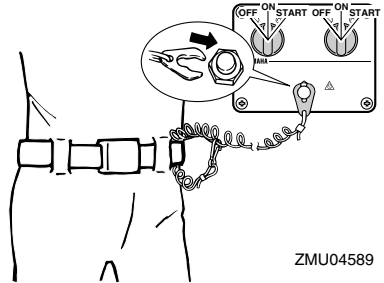
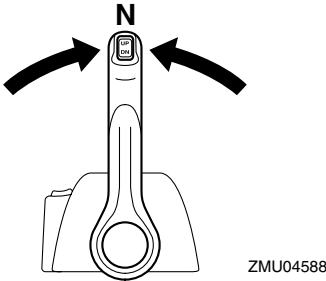
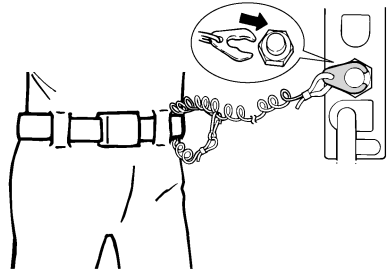
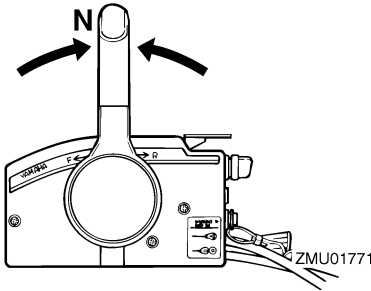

2. Attach the engine shut-off cord to a secure place on your clothing, or your arm or leg. Then install the clip on the other end of the cord into the engine shut-off switch.

3. Turn the main switch to “ON” (on).

**NOTE:**

Dual engine users: When the main switch is turned on, the buzzer operates for a few seconds then stops automatically. The buzzer also operates if one of the engines stalls.

EWM00121

**WARNING**

- Attach the engine shut-off cord to a secure place on your clothing, or your arm or leg while operating.
- Do not attach the cord to clothing that could tear loose. Do not route the cord where it could become entangled, preventing it from functioning.
- Avoid accidentally pulling the cord during normal operation. Loss of engine power means the loss of most steering control. Also, without engine power, the boat could slow rapidly. This could cause people and objects in the boat to be thrown forward.

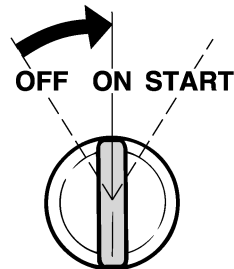

4. Turn the main switch to “START” (start), and hold it for a maximum of 5 seconds.

# Operation

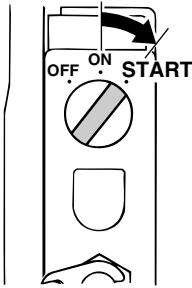

ZMU01881

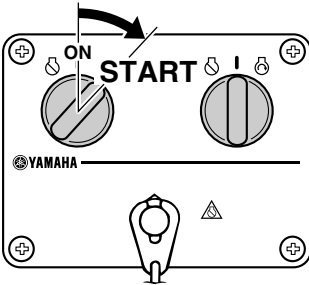

ZMU04590

5. Immediately after the engine starts, release the main switch to return it to "ON" (on).

ECM00191

## CAUTION:

- Never turn the main switch to "START" (start) while the engine is running.
- Do not keep the starter motor turning for more than 5 seconds. If the starter motor is turned continuously for more than 5 seconds, the battery will be quickly discharged, thus making it impossible to start the engine. The starter can also be damaged. If the engine will not start after 5 seconds of cranking, return the main switch to "ON" (on), wait 10 seconds, then crank the engine again.

EMU27670

## Warming up engine

EMU30033

### Electric start models

1. After starting the engine, allow it to idle for 3 minutes to warm up. Failure to do so will shorten engine life.
2. Be sure the low oil pressure-warning indicator remains off after starting the engine.
3. Check for a steady flow of water from the cooling water pilot hole.

ECM01343

## CAUTION:

- If the low oil pressure-warning indicator blinks after the engine starts, stop the engine. Otherwise serious engine damage could occur. Check the oil level and add oil if necessary. Consult your Yamaha dealer if the cause for the low oil pressure-warning indicator cannot be found.
- A continuous flow of water from the pilot hole shows that the water pump is pumping water through the cooling passages. If water is not flowing out of the pilot hole at all times while the engine is running, overheating and serious damage could occur. Stop the engine and check whether the cooling water inlet on the lower case or the cooling water pilot hole is blocked. Consult your Yamaha dealer if the problem cannot be located and corrected.
- If the cooling passage is frozen, it may take awhile for water to start flowing out of the pilot hole.

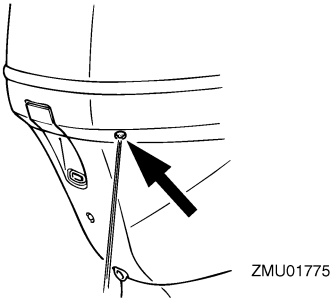

EMU31730

## Shifting

EWM00180

### **WARNING**

Before shifting, make sure there are no swimmers or obstacles in the water near you.

ECM01610

### **CAUTION:**

Warm up the engine before shifting into gear. Until the engine is warm, the idle speed may be higher than normal. High idle speed can prevent you from shifting back to neutral. If this occurs, stop the engine, shift to neutral, then restart the engine and allow it to warm up.

#### To shift out of neutral

1. Pull the neutral interlock trigger up (if equipped).

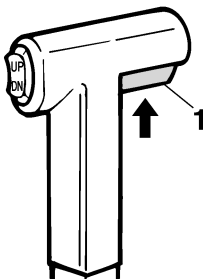

ZMU01727

1. Neutral interlock trigger

2. Move the remote control lever firmly and crisply forward (for forward gear) or backward (for reverse gear) about 35° (a detent can felt).

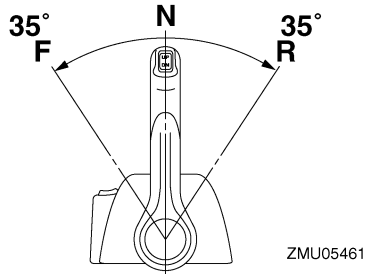
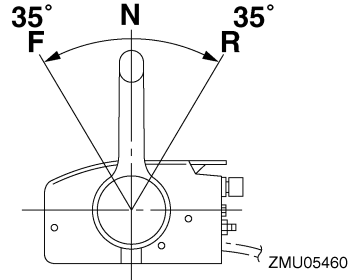

#### To shift from in gear (forward/reverse) to neutral

1. Close the throttle so that the engine slows to idle speed.

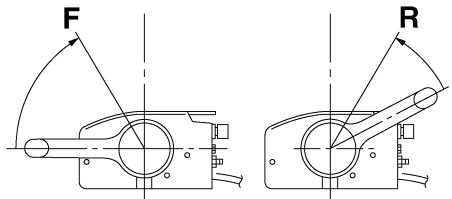

ZMU05462

# Operation

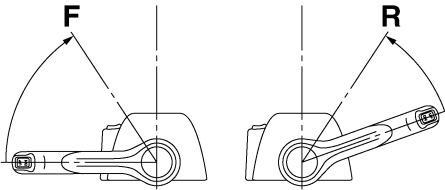

ZMU05463

2. After the engine is at idle speed in gear move the remote control lever firmly and crisply into the neutral position.

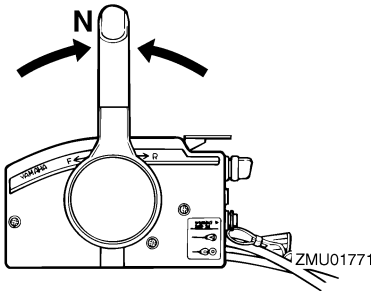

ZMU01771

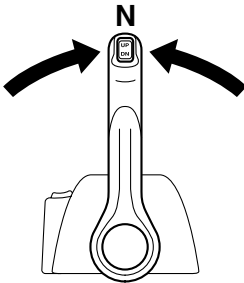

ZMU04588

EMU31742

## Stopping boat

EWM01510

### **WARNING**

- Do not use the reverse function to slow down or stop the boat as it could cause you to lose control, be ejected, or impact the steering wheel or other parts of the

boat. This could increase the risk of serious injury. It could also damage the shift mechanism.

- Do not shift into reverse while traveling at planing speeds. Loss of control, boat swamping, or damage to the boat could occur.

The boat is not equipped with a separate braking system. Water resistance stops it after the throttle lever is moved back to idle. The stopping distance varies depending on gross weight, water surface conditions, and wind direction.

EMU27820

## Stopping engine

Before stopping the engine, first let it cool off for a few minutes at idle or low speed. Stopping the engine immediately after operating at high speed is not recommended.

EMU27853

### Procedure

1. Turn the main switch to "OFF" (off).

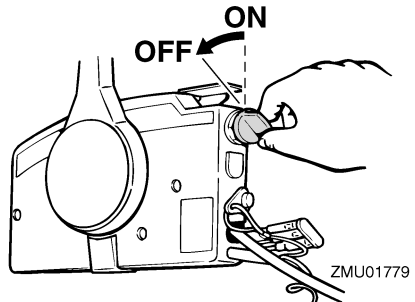

ZMU01779



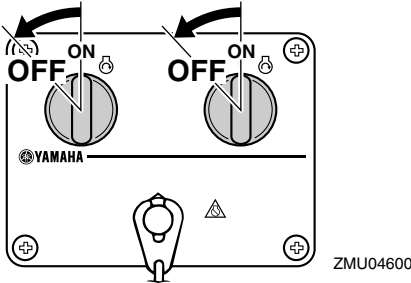

2. After stopping the engine, disconnect the fuel line or close the fuel cock if there is a fuel joint or a fuel cock on the boat.
3. Tighten the air vent screw on the fuel tank cap (if equipped).
4. Remove the key if the boat will be left unattended.

## NOTE:

The engine can also be stopped by pulling the cord and removing the clip from the engine shut-off switch, then turning the main switch to "OFF" (off).

EMU27861

## Trimming outboard motor

The trim angle of the outboard motor helps determine the position of the bow of the boat in the water. Correct trim angle will help improve performance and fuel economy while reducing strain on the engine. Correct trim angle depends upon the combination of boat, engine, and propeller. Correct trim is also affected by variables such as the load in the boat, sea conditions, and running speed.

EWM00740

## WARNING

**Excessive trim for the operating conditions (either trim up or trim down) can cause boat instability and can make steering the boat more difficult. This increases**

**the possibility of an accident. If the boat begins to feel unstable or is hard to steer, slow down and/or readjust the trim angle.**

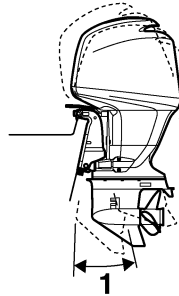

1. Trim operating angle

ZMU01780

EMU27883

## Adjusting trim angle (Power trim and tilt)

EWM00752

### WARNING

- Be sure all people are clear of the outboard motor when adjusting the tilt angle. Body parts can be crushed between the motor and the clamp bracket when the motor is trimmed or tilted.
- Use caution when trying a trim position for the first time. Increase speed gradually and watch for any signs of instability or control problems. Improper trim angle can cause loss of control.
- If equipped with a power trim and tilt switch located on the bottom cowling, use the switch only when the boat is at a complete stop with the engine off. Do not adjust the trim angle with this switch while the boat is moving.

Adjust the outboard motor trim angle using the power trim and tilt switch.

# Operation

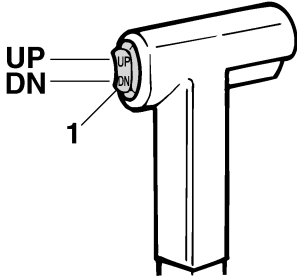

ZMU01781

1. Power trim and tilt switch

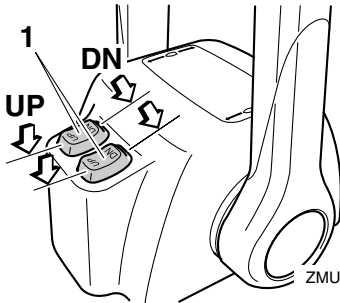

ZMU04601

1. Power trim and tilt switch

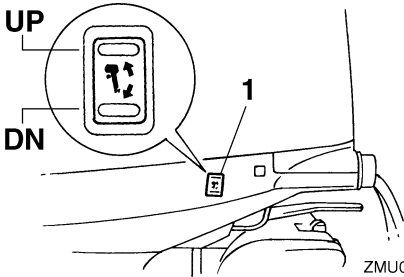

ZMU04743

1. Power trim and tilt switch

To raise the bow (trim-out), press the switch “UP” (up).

To lower the bow (trim-in), press the switch “DN” (down).

Make test runs with the trim set to different angles to find the position that works best for your boat and operating conditions.

EMU27911

## Adjusting boat trim

When the boat is on plane, a bow-up attitude results in less drag, greater stability and efficiency. This is generally when the keel line of the boat is up about 3 to 5 degrees. With the bow up, the boat may have a greater tendency to steer to one side or the other. Compensate for this as you steer. The trim tab can also be adjusted to help offset this effect. When the bow of the boat is down, it is easier to accelerate from a standing start onto plane.

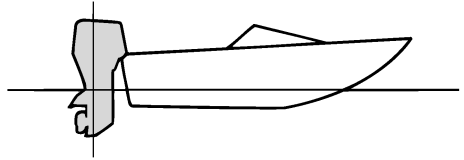

ZMU01784

## Bow Up

Too much trim-out puts the bow of the boat too high in the water. Performance and economy are decreased because the hull of the boat is pushing the water and there is more air drag. Excessive trim-out can also cause the propeller to ventilate, which reduces performance further, and the boat may “porpoise” (hop in the water), which could throw the operator and passengers overboard.

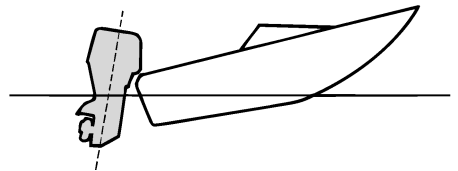

ZMU01785

## Bow Down

Too much trim-in causes the boat to “plow” through the water, decreasing fuel economy and making it hard to increase speed. Operating with excessive trim-in at higher speeds also makes the boat unstable. Resistance at the bow is greatly increased, heightening the danger of “bow steering” and making operation difficult and dangerous.

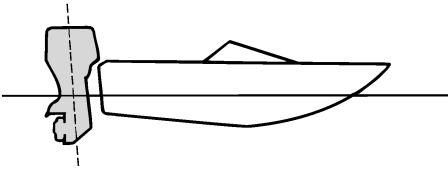

ZMU01786

## NOTE:

Depending on the type of boat, the outboard motor trim angle may have little effect on the trim of the boat when operating.

EMU27934

## Tilting up and down

If the engine will be stopped for some time or if the boat is moored in shallows, the outboard motor should be tilted up to protect the propeller and lower casing from damage by collision with obstructions, and also to reduce salt corrosion.

EWMM00221

## WARNING

Be sure all people are clear of the outboard motor when tilting up and down, Body parts can be crushed between the motor and the clamp bracket when the motor is trimmed or tilted.

EWMM00250

## WARNING

Leaking fuel is a fire hazard. If there is a fuel joint on the outboard motor, disconnect the fuel line or close the fuel cock if the engine will be tilted for more than a few minutes. Otherwise fuel may leak.

ECM00241

## CAUTION:

- Before tilting the outboard motor, stop the engine by following the procedure on page 42. Never tilt the outboard motor while the engine is running. Severe damage from overheating can result.
- Do not tilt up the engine by pushing the tiller handle (if equipped) because this could break the handle.

EMU32722

## Procedure for tilting up (power trim and tilt models)

1. Place the remote control lever in neutral.

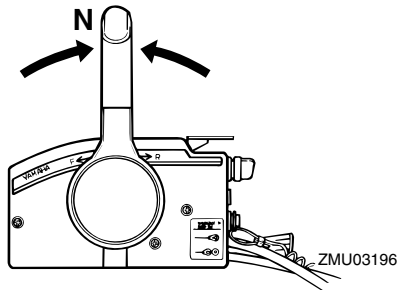

ZMU03196

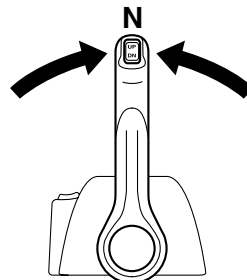

ZMU04588

# Operation

2. Press the power trim and tilt switch “UP” (up) until the outboard motor has tilted up completely.

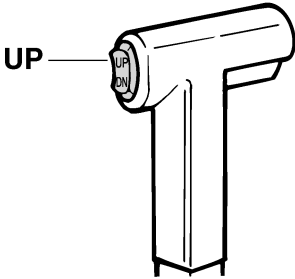

ZMU01787

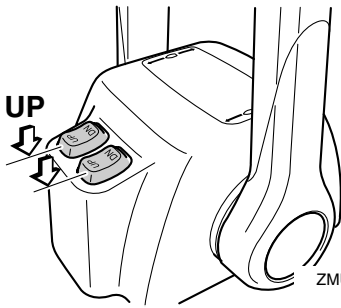

ZMU04602

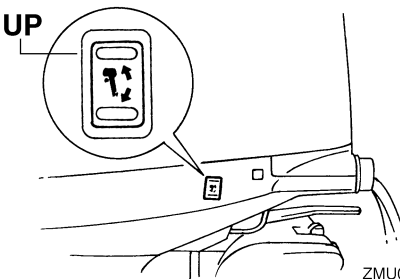

ZMU01789

3. Pull the tilt support lever toward you to support the engine.

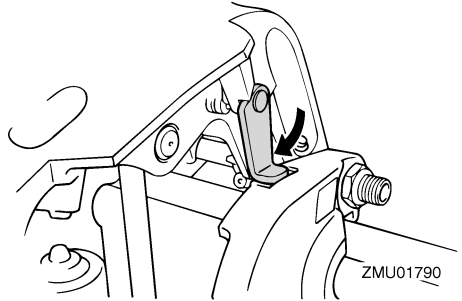

EWM00261

## **WARNING**

After tilting the outboard motor, be sure to support it with the tilt support knob or tilt support lever. Otherwise the outboard motor could fall back down suddenly if oil in the power trim and tilt unit or in the power tilt unit loses pressure.

ECM01640

## **CAUTION:**

Do not use the tilt support lever or knob when trailering the boat. The outboard motor could shake loose from the tilt support and fall. If the motor cannot be trailered in the normal running position, use an additional support device to secure it in the tilt position. For more detailed information, see page 50.

4. Models equipped with trim rods: Once the outboard motor is supported with the tilt support lever, press the power trim and tilt switch “DN” (down) to retract the trim rods.

ECM00250

## **CAUTION:**

Be sure to retract the trim rods completely during mooring. This protects the rods from marine growth and corrosion which could damage the power trim and tilt mechanism.

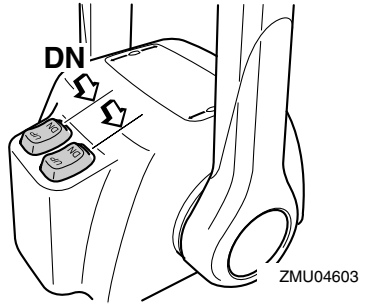
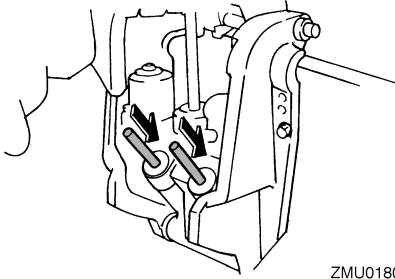

EMU33120

## Procedure for tilting down (power trim and tilt models)

1. Push the power trim and tilt switch “UP” (up) until the outboard motor is supported by the tilt rod and the tilt support lever becomes free.
2. Release the tilt support lever.

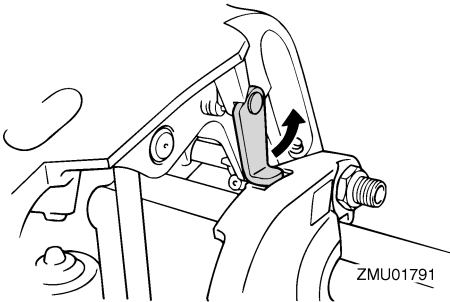
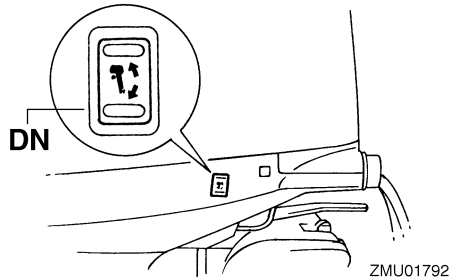

3. Push the power trim and tilt switch “DN” (down) to lower the outboard motor to the desired position.

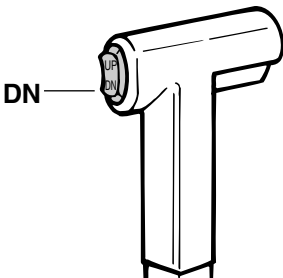

EMU28060

## Cruising in shallow water

The outboard motor can be tilted up partially to allow operation in shallow water.

EMU32850

### Power trim and tilt models

The outboard motor can be tilted up partially to allow operation in shallow water.

EWM00660

### **! WARNING**

- Place the gear shift in neutral before setting up for shallow water cruising.
- Return the outboard motor to its normal position as soon as the boat is back in deeper water.

ECM00260

### **CAUTION:**

Do not tilt the outboard motor up so that the cooling water inlet on the lower unit is above the surface of the water when set-

# Operation

ting up for and cruising in shallow water. Otherwise severe damage from overheating can result.

EMU32920

## Procedure for power trim and tilt

1. Place the remote control lever in neutral.

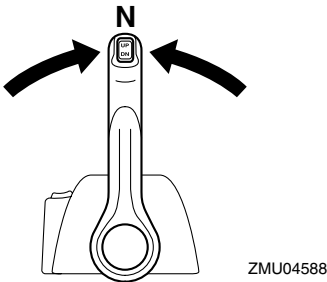
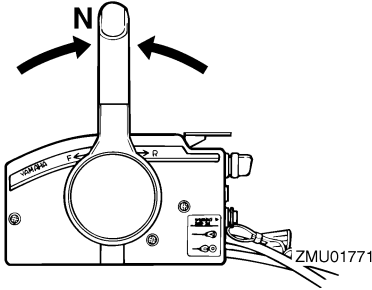

2. Slightly tilt the outboard motor up to the desired position using the power trim and tilt switch.

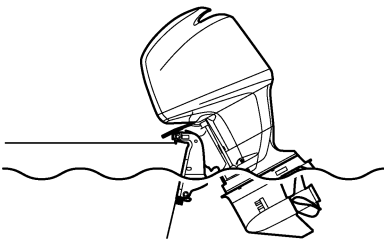

3. To return the outboard motor to the normal running position, press the power trim and tilt switch and slowly tilt the outboard motor down.

EMU28193

## Cruising in other conditions

### Cruising in salt water

After operating in salt water, flush the cooling water passages with fresh water to prevent them from becoming clogged. Also rinse the outside of the outboard motor with fresh water and, if possible, rinse the power head under the cowling.

### Cruising in muddy or turbid water

Yamaha strongly recommends that you use the optional chromium-plated water pump kit (available for V4 and large engines) if you use the outboard motor in water with a lot of sediment in it, such as muddy or other turbid (cloudy) water.

### Cruising in acidic water

Water in some areas can be acidic. After operating in such water, flush the cooling passages with fresh water to prevent corrosion. Also rinse the outside of the outboard motor with fresh water.

EMU34520

## Specifications

### NOTE: \_\_\_\_\_

“(AL)” stated in the specification data below represents the numerical value for the aluminum propeller installed.

Likewise, “(SUS)” represents the value for stainless steel propeller installed and “(PL)” for plastic propeller installed.

### NOTE: \_\_\_\_\_

“\*\*” means, select the engine oil referring to the chart of engine oil paragraph. For further information, see page 9.

EMU28219

### Dimension:

Overall length:

822 mm (32.4 in)

Overall width:

511 mm (20.1 in)

Overall height L:

1714 mm (67.5 in)

Overall height X:

1842 mm (72.5 in)

Transom height L:

516 mm (20.3 in)

Transom height X:

643 mm (25.3 in)

Weight (AL) L:

F150AET 214.0 kg (472 lb)

Weight (AL) X:

F150AET 218.0 kg (481 lb)

Weight (SUS) L:

216.0 kg (476 lb)

Weight (SUS) X:

220.0 kg (485 lb)

### Performance:

Full throttle operating range:

5000–6000 r/min

Maximum output:

110.3 kW@5500 r/min (150 HP@5500 r/min)

Idling speed (in neutral):

700 ±50 r/min

### Engine:

Type:

4-stroke L

Displacement:

2670.0 cm<sup>3</sup>

Bore × stroke:

94.0 × 96.2 mm (3.70 × 3.79 in)

Ignition system:

TCI

Spark plug (NGK):

LFR5A-11

Spark plug gap:

1.0–1.1 mm (0.039–0.043 in)

Control system:

Remote control

Starting system:

Electric

Starting carburetion system:

Electronic fuel injection

Valve clearance (cold engine) IN:

0.17–0.23 mm (0.0067–0.0091 in)

Valve clearance (cold engine) EX:

0.31–0.37 mm (0.0122–0.0146 in)

Min. cold cranking amps (CCA/EN):

711.0 A

Min. rated capacity (20HR/IEC):

100.0 Ah

Maximum generator output:

35.0 A

### Drive unit:

Gear positions:

Forward-neutral-reverse

Gear ratio:

2.00 (28/14)

Trim and tilt system:

Power trim and tilt

Propeller mark:

F150AET M

FL150AET ML

### Fuel and oil:

Recommended fuel:

Regular unleaded gasoline

Min. research octane:

90

Recommended engine oil:

4-stroke outboard motor oil

Recommended engine oil group 1\*:

SAE 10W-30/10W-40/5W-30

API SE/SF/SG/SH/SJ/SL

# Maintenance

---

Recommended engine oil group 2\*:

SAE 15W-40/20W-40/20W-50

API SH/SJ/SL

Lubrication:

Wet sump

Engine oil quantity (excluding oil filter):

5.2 L (5.50 US qt) (4.58 Imp.qt)

Recommended gear oil:

Hypoid gear oil SAE#90

Gear oil quantity:

F150AET 980.0 cm<sup>3</sup> (33.13 US oz) (34.56 Imp.oz)

FL150AET 870.0 cm<sup>3</sup> (29.41 US oz) (30.68 Imp.oz)

## Tightening torque for engine:

Spark plug:

25.0 Nm (18.4 ft-lb) (2.55 kgf-m)

Propeller nut:

55.0 Nm (40.6 ft-lb) (5.61 kgf-m)

Engine oil drain bolt:

28.0 Nm (20.7 ft-lb) (2.86 kgf-m)

Engine oil filter:

18.0 Nm (13.3 ft-lb) (1.84 kgf-m)

## Noise and vibration level:

Operator sound pressure level (ICOMIA 39/94 and 40/94):

79.6 dB(A)

EMU28223

## Transporting and storing outboard motor

EWM00690

### WARNING

- **Leaking fuel is a fire hazard. When transporting and storing the outboard motor, close the air vent screw and fuel cock to prevent fuel from leaking.**
  - **USE CARE when transporting fuel tank, whether in a boat or car.**
  - **DO NOT fill fuel container to maximum capacity. Gasoline will expand considerably as it warms up and can build up pressure in the fuel container. This can cause fuel leakage and a potential fire hazard.**
- 

EWM00700

### WARNING

**Never get under the lower unit while it is tilted, even if a motor support bar is used. Severe injury could occur if the outboard motor accidentally falls.**

---

ECM00660

### CAUTION:

**Do not use the tilt support lever or knob when trailering the boat. The outboard motor could shake loose from the tilt support and fall. If the motor cannot be trailered in the normal running position, use an additional support device to secure it in the tilt position.**

---

The outboard motor should be trailered and stored in the normal running position. If there is insufficient road clearance in this position, then trailer the outboard motor in the tilt position using a motor support device such as a transom saver bar. Consult your Yamaha dealer for further details.

EMU30041

## Storing outboard motor

When storing your Yamaha outboard motor for prolonged periods of time (2 months or longer), several important procedures must be performed to prevent excessive damage. It is advisable to have your outboard motor serviced by an authorized Yamaha dealer prior to storage. However, you, the owner, with a minimum of tools, can perform the following procedures.

ECM01350

### CAUTION:

- **To prevent problems which can be caused by oil entering the cylinder from the sump, keep the outboard motor in the attitude shown when transporting**



and storing it. Do not store or transport the outboard motor on its side (not up-right).

- Do not place the outboard motor on its side before the cooling water has drained from it completely, otherwise water may enter the cylinder through the exhaust port and cause engine trouble.
- Store the outboard motor in a dry, well-ventilated place, not in direct sunlight.
- Drain the remaining gasoline from the vapor separator. Gasoline left in the vapor separator for a prolonged period of time will break down and could cause damage to the fuel line.

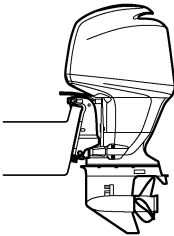

ZMU01835

EMU28303

## Procedure

EMU30870

### Flushing with the flushing attachment

1. Wash the outboard motor body using fresh water. For further information, see page 54.
2. Disconnect the fuel line from the motor or shut off the fuel cock, if equipped.
3. Remove the top cowling and propeller.
4. Install the flushing attachment over the cooling water inlet.

ECM00300

### CAUTION:

Do not run the engine without supplying it with cooling water. Either the engine water pump will be damaged or the engine will

be damaged from overheating. Before starting the engine, be sure to supply water to the cooling water passages.

ECM00310

### CAUTION:

Avoid running the outboard motor at high speed while on the flushing attachment, otherwise overheating could occur.

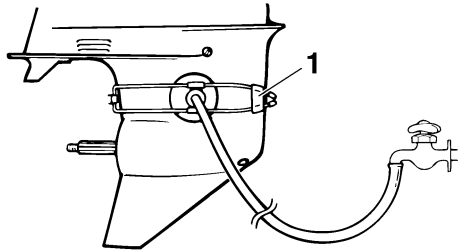

ZMU01830

1. Flushing attachment
5. Cooling system flushing is essential to prevent the cooling system from clogging up with salt, sand, or dirt. In addition, fogging/lubricating the engine is mandatory to prevent excessive engine damage due to rust. Perform the flushing and fogging at the same time.

EWM00090

### WARNING

- Do not touch or remove electrical parts when starting or during operation.
- Keep hands, hair, and clothes away from the flywheel and other rotating parts while the engine is running.

### NOTE:

- When using the flushing attachment, maintain adequate water pressure so that there is a steady flow of water from the cooling water pilot hole.

# Maintenance

- If the overheat warning device is activated, turn the engine off, and consult your Yamaha dealer.

6. Run the engine at a fast idle for a few minutes in neutral position.
7. Just prior to turning off the engine, quickly spray "Fogging Oil" alternately into the intake silencer or the fogging hole of the silencer cover, if equipped. When properly done, the engine will smoke excessively and almost stall.
8. Drain the remained gasoline in the vapor separator with a container. Loosen the drain screw, and then remove the cap. Push in the air valve with a screwdriver to introduce air into the float chamber, so that the gasoline will drain smoothly. Then, tighten the drain screw.

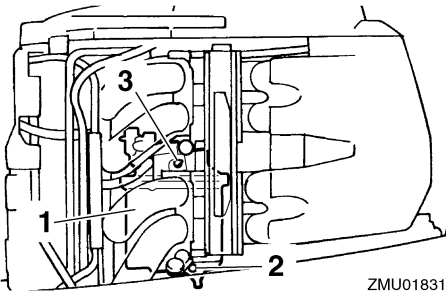

ZMU01831

1. Vapor separator
2. Drain screw
3. Cap

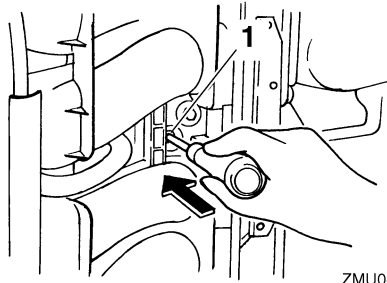

ZMU04825

1. Air valve
9. Remove the flushing attachment.
10. Install the top cowl.
11. If "Fogging Oil" is not available, turn off the engine after the 6 step. Then perform the 8 step procedure.
12. Drain the cooling water completely out of the motor. Clean the body thoroughly.
13. If the "Fogging Oil" is not available, remove the spark plug(s). Pour a teaspoonful of clean engine oil into each cylinder. Crank several times manually. Replace the spark plug(s).

## NOTE:

A flushing attachment is available from your Yamaha dealer.

EMU28402

## Lubrication

1. Install the spark plug(s) and torque to proper specification. For information on spark plug installation, see page 59.
2. Change the gear oil. For instructions, see page 66. Inspect the oil for the presence of water that indicates a leaky seal. Seal replacement should be performed by an authorized Yamaha dealer prior to use.
3. Grease all grease fittings. For further details, see page 59.

---

**NOTE:**

For long-term storage, fogging the engine with oil is recommended. Contact your Yamaha dealer for information about fogging oil and procedures for your engine.

---

EMU28431**Battery care**EWM00330

**Battery electrolytic fluid is dangerous; it contains sulfuric acid and therefore is poisonous and highly caustic.**

**Always follow these preventive measures:**

- **Avoid bodily contact with electrolytic fluid as it can cause severe burns or permanent eye injury.**
- **Wear protective eye gear when handling or working near batteries.**

**Antidote (EXTERNAL):**

- **SKIN - Flush with water.**
- **EYES - Flush with water for 15 minutes and get immediate medical attention.**

**Antidote (INTERNAL):**

- **Drink large quantities of water or milk followed by milk of magnesia, beaten egg, or vegetable oil. Get immediate medical attention.**

**Batteries also generate explosive hydrogen gas; therefore, you should always follow these preventive measures:**

- **Charge batteries in a well-ventilated area.**
- **Keep batteries away from fire, sparks, or open flames (for example: welding equipment, lighted cigarettes, and so on.)**
- **DO NOT SMOKE when charging or handling batteries.**

**KEEP BATTERIES AND ELECTROLYTIC FLUID OUT OF REACH OF CHILDREN.**

---

Follow the manual of the battery for the handling of the battery. Batteries vary among manufacturers. Therefore the following procedures may not always apply. Consult your battery manufacturer's instructions.

Procedure

1. Disconnect and remove the battery from the boat. Always disconnect the black negative cable first to prevent the risk of shorting.
2. Clean the battery casing and terminals. Fill each cell to the upper level with distilled water.
3. Store the battery on a level surface in a cool, dry, well-ventilated place out of direct sunlight.
4. Once a month, check the specific gravity of the electrolyte and recharge as required to prolong battery life.

EMU28442**Flushing power unit**

Perform this procedure right after operation for the most thorough flushing.

ECM01530**CAUTION:**

**Do not perform this procedure while the engine is running. The water pump may be damaged and severe damage from overheating can result.**

---

1. After shutting off the engine, unscrew the garden hose connector from the fitting on the bottom cowling.

# Maintenance

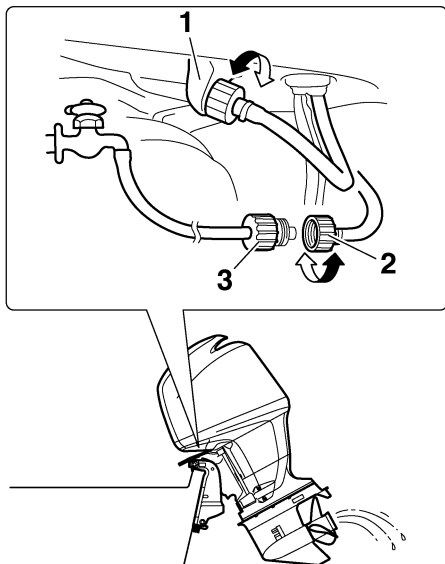

ZMU01794

1. Fitting
  2. Garden hose connector
  3. Garden hose adapter
2. Screw the garden hose adapter onto a garden hose, which is connected to a fresh water supply, and then connect it to the garden hose connector.
  3. With the engine off, turn on the water tap and let the water flush through the cooling passages for about 15 minutes. Turn off the water and disconnect the garden hose adapter from the garden hose connector.
  4. Reinstall the garden hose connector onto the fitting on the bottom cowling. Tighten the connector securely.

ECM00540

## CAUTION:

**Do not leave the garden hose connector loose on the bottom cowling fitting or let the hose hang free during normal operation. Water will leak out of the connector**

instead of cooling the engine, which can cause serious overheating. Be sure the connector is tightened securely on the fitting after flushing the engine.

## NOTE:

- When flushing the engine with the boat in the water, tilting up the outboard motor until it is completely out of the water will achieve better results.
- For cooling system flushing instructions, see page 50.

EMU28450

## Cleaning the outboard motor

After use, wash the exterior of the outboard motor with fresh water. Flush the cooling system with fresh water.

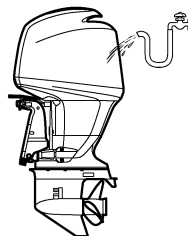

ZMU01795

## NOTE:

For cooling system flushing instructions, see page 50.

EMU28460

## Checking painted surface of motor

Check the motor for scratches, nicks, or flaking paint. Areas with damaged paint are more likely to corrode. If necessary, clean and paint the areas. A touch-up paint is available from your Yamaha dealer.

EMU28478

## Periodic maintenance

EWM01071



**Be sure to turn off the engine when you perform maintenance unless otherwise specified. If you are not familiar with machine servicing, this work should be done by your Yamaha dealer or other qualified mechanic.**

---

EMU28511

## Replacement parts

If replacement parts are necessary, use only genuine Yamaha parts or parts of equivalent design and quality. Any part of inferior quality may malfunction, and the resulting loss of control could endanger the operator and passengers. Yamaha genuine parts and accessories are available from your Yamaha dealer.

EMU34150

## Severe operating conditions

Severe operating conditions involve one or more of the following types of operation on a regular basis:

- Operating continuously at or near maximum engine speed (rpm) for many hours
- Operating continuously at a low engine speed (rpm) for many hours
- Brief periods of rapid acceleration and deceleration followed by engine shut off before the engine has reached proper operating temperature
- Frequent quick acceleration and deceleration
- Frequent shifting
- Frequently starting and stopping the engine(s)
- Operation that fluctuates often between light and heavy cargo loads

Outboard motors operating under any of these above conditions require more frequent maintenance. Yamaha recommends that you do this service twice as often as specified in the maintenance chart. For example, if a particular service should be done at 50 hours, do it instead at 25 hours. This will help prevent more rapid deterioration of engine components.

# Maintenance

EMU34443

## Maintenance chart 1

### NOTE:

- Refer to the sections in this chapter for explanations of each owner-specific action.
- The maintenance cycle on these charts assume usage of 100 hours per year and regular flushing of the cooling water passages. Maintenance frequency should be adjusted when operating the engine under adverse conditions such as extended trolling.
- Disassembly or repairs may be necessary depending on the outcome of maintenance checks.
- Expendable or consumable parts and lubricants will lose their effectiveness over time and through normal usage regardless of the warranty period.
- When operating in salt water, muddy, other turbid (cloudy), acidic water, the engine should be flushed with clean water after each use.

The “●” symbol indicates the check-ups which you may carry out yourself.

The “○” symbol indicates work to be carried out by your Yamaha dealer.

Item	Actions	Initial	Every		
		20 hours (3 months)	100 hours (1 year)	300 hours (3 years)	500 hours (5 years)
Anode(s) (external)	Inspection or replacement as necessary		●/○		
Anode(s) (cylinder head, thermostat cover)	Inspection or replacement as necessary		○		
Anode(s) (exhaust cover, cover joint)	Replacement				○
Battery	Inspection or charging, replacement as necessary	●/○	●/○		
Cooling water leakage	Inspection or replacement as necessary	○	○		
Cowling clamp	Inspection		●/○		
Engine starting condition/Noise	Inspection	●/○	●/○		
Engine idling speed/Noise	Inspection	●/○	●/○		
Engine oil	Replacement	●/○	●/○		
Engine Oil filter (cartridge)	Replacement		●/○		
Fuel filter (can be disassembled)	Inspection or replacement as necessary	●/○	●/○		
Fuel filter (vapor separator tank)	Replacement				○

# Maintenance

Item	Actions	Initial	Every			
		20 hours (3 months)	100 hours (1 year)	300 hours (3 years)	500 hours (5 years)	
Fuel pump	Inspection or replacement as necessary			○		
Fuel/oil leakage	Inspection	○	○			
Fuel pipe	Inspection or replacement as necessary	○	○			
Fuel pipe	Replacement			○		
Gear oil	Replacement	●/○	●/○			
Greasing points	Greasing	●/○	●/○			
Impeller/water pump housing	Inspection or replacement as necessary		○			
Impeller/water pump housing	Replacement			○		
Power trim/tilt unit	Inspection	●/○	●/○			
Propeller/Propeller nut/Cotter pin	Inspection or replacement as necessary	●/○	●/○			
PCV (Pressure Control Valve)	Inspection or replacement as necessary		○			
Shift link/shift cable	Inspection, adjustment or replacement as necessary	○	○			
Spark plug(s)	Inspection, adjustment or replacement as necessary		●/○			
Spark plug caps/high tension cordes	Inspection or replacement as necessary	○	○			
Pilot water	Inspection	●/○	●/○			
Throttle link/Throttle cable/Throttle pick-up timing	Inspection, adjustment or replacement as necessary	○	○			
Thermostat	Inspection or replacement as necessary		○			
Timing belt	Inspection or replacement as necessary		○			
Valve clearance	Inspection and adjustment				○	
Water inlet	Inspection	●/○	●/○			
Main switch/stop switch/choke switch	Inspection or replacement as necessary	○	○			

# Maintenance

---

Item	Actions	Initial	Every			
		20 hours (3 months)	100 hours (1 year)	300 hours (3 years)	500 hours (5 years)	
Wire harness connections/Wire coupler connections	Inspection or replacement as necessary	○	○			
(Yamaha) Meter/gauge	Inspection	○	○			

EMU34450

## Maintenance chart 2

Item	Actions	Every
		1000 hours
Guide exhaust/exhaust manifold	Inspection or replacement as necessary	○
Timing belt	Replacement	○

EMU28910

### NOTE:

---

When using lead or high-sulfur gasoline, inspecting valve clearance may be required more frequently than every 500 hours.

---



EMU28941

## Greasing

Yamaha grease A (water resistant grease)

Yamaha grease D (corrosion resistant grease; for propeller shaft)

F150A, FL150A

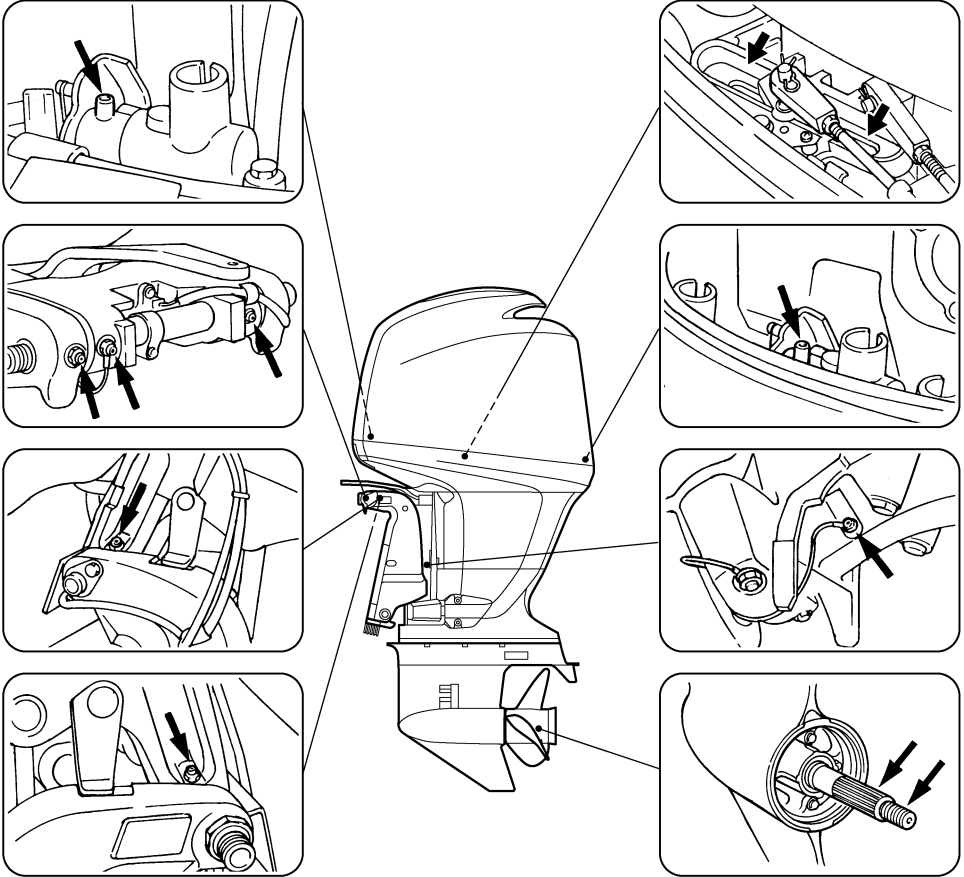

ZMU01796

EMU28953

## Cleaning and adjusting spark plug

EWMM00560

### **⚠ WARNING**

When removing or installing a spark plug, be careful not to damage the insulator. A damaged insulator could allow external sparks, which could lead to explosion or fire.

EWMM01550

### **⚠ WARNING**

The engine will still be very hot when it has just been turned off. Take extremely care so that neither you nor anyone else gets burnt. To avoid burns, work on the engine when it has cooled down.

# Maintenance

The spark plug is an important engine component and is easy to inspect. The condition of the spark plug can indicate something about the condition of the engine. For example, if the center electrode porcelain is very white, this could indicate an intake air leak or carburetion problem in that cylinder. Do not attempt to diagnose any problems yourself. Instead, take the outboard motor to a Yamaha dealer. You should periodically remove and inspect the spark plug because heat and deposits will cause the spark plug to slowly break down and erode. If electrode erosion becomes excessive, or if carbon and other deposits are excessive, you should replace the spark plug with another of the correct type.

Standard spark plug:  
LFR5A-11

Before fitting the spark plug, measure the electrode gap with a wire thickness gauge; adjust the gap to specification if necessary.

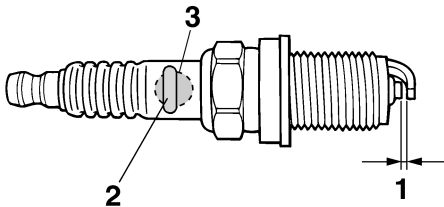

ZMU01797

1. Spark plug gap
2. Spark plug part number
3. Spark plug I.D. mark (NGK)

Spark plug gap:  
1.0–1.1 mm (0.039–0.043 in)

When fitting the plug, always clean the gasket surface and use a new gasket. Wipe off any dirt from the threads and screw in the spark plug to the correct torque.

Spark plug torque:  
25.0 Nm (18.4 ft-lb) (2.55 kgf-m)

## NOTE:

If a torque-wrench is not available when you are fitting a spark plug, a good estimate of the correct torque is 1/4 to 1/2 a turn past finger-tight. Have the spark plug adjusted to the correct torque as soon as possible with a torque-wrench.

EMU28962

## Checking fuel system

EWM00060

### WARNING

Gasoline and its vapors are highly flammable and explosive. Keep away from sparks, cigarettes, flames, or other sources of ignition.

EWM00910

### WARNING

Leaking fuel can result in fire or explosion.

- Check for fuel leakage regularly.
- If any fuel leakage is found, the fuel system must be repaired by a qualified mechanic. Improper repairs can make the outboard unsafe to operate.

Check the fuel lines for leaks, crack, or malfunction. If a problem is found, your Yamaha dealer or other qualified mechanic should repair it immediately.

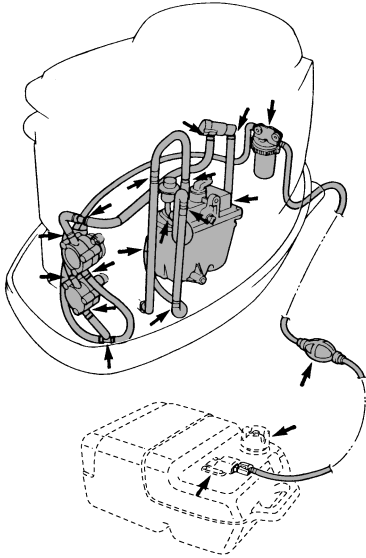

ZMU01798

## Checkpoints

- Fuel system parts leakage
- Fuel line joint leakage
- Fuel line cracks or other damage
- Fuel connector leakage

EMU35630

## Changing engine oil

EWM00760

### **! WARNING**

- **Avoid draining the engine oil immediately after stopping the engine. The oil is hot and should be handled with care to avoid burns.**
- **Be sure the outboard motor is securely fastened to the transom or a stable stand.**

ECM00970

### **CAUTION:**

- **Do not overfill the oil, and be sure the outboard motor is upright (not tilted) when checking and changing the engine oil.**

- **If the oil level is above the upper level mark, drain until the level meets the specified capacity. Overfilling the oil could cause leakage or damage.**

ECM01710

### **CAUTION:**

**Change the engine oil after the first 20 hours of operation or 3 months, and every 100 hours or at 1-year intervals thereafter. Otherwise the engine will wear quickly.**

### **NOTE:**

Change the engine oil when the oil is still warm.

1. Put the outboard motor in an upright position (not tilted).

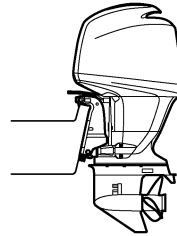

ZMU01835

2. Prepare a suitable container that holds a larger amount than the engine oil capacity. Loosen and remove the drain screw while holding the container under the drain hole. Then remove the oil filler cap. Let the oil drain completely. Wipe up any spilled oil immediately.

# Maintenance

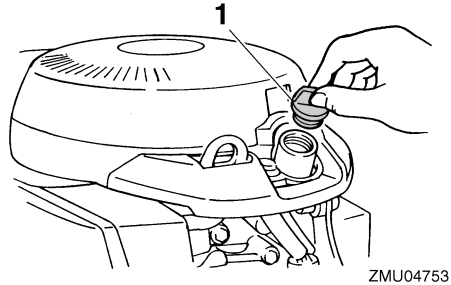
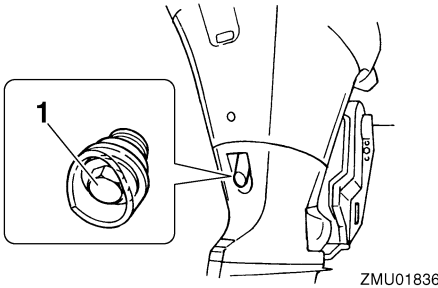

1. Drain screw
3. Put a new gasket on the oil drain screw. Apply a light coat of oil to the gasket and install the drain screw.

Drain screw tightening torque:  
28.0 Nm (20.7 ft-lb) (2.86 kgf-m)

## NOTE:

If a torque wrench is not available when you are installing the drain screw, finger tighten the screw just until the gasket comes into contact with the surface of the drain hole. Then tighten 1/4 to 1/2 turn more. Tighten the drain screw to the correct torque with a torque wrench as soon as possible.

4. Add the correct amount of oil through the filler hole. Install the filler cap.

Recommended engine oil:  
4-stroke outboard motor oil  
Engine oil quantity (excluding oil filter):  
5.2 L (5.50 US qt) (4.58 Imp.qt)

1. Oil filler cap
5. Remove oil dipstick and wipe it clean.
6. Completely insert the dipstick and remove it again.
7. Check the oil level using the dipstick to be sure the level falls between the upper level mark and lower level mark. Fill with oil if it is below the lower level mark, or drain to the specified level if it is above the upper level mark.

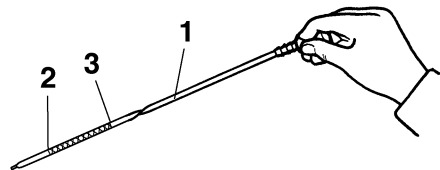

1. Oil dipstick
2. Lower level mark
3. Upper level mark
8. Start the engine and watch to make sure the low oil pressure-warning indicator (if equipped) turns off. Make sure that there are no oil leaks.

ECM00681

## CAUTION:

If the low oil pressure-warning indicator does not turn off or if there are oil leaks, stop the engine and find the cause. Continued operation with a problem could cause severe engine damage. Consult your Yamaha dealer if the problem cannot be located and corrected.

9. Dispose of used oil according to local regulations.

## NOTE:

- For more information on the disposal of used oil, consult your Yamaha dealer.
- Change the oil more often when operating the engine under adverse conditions such as extended trolling.

EMU29112

## Checking wiring and connectors

- Check that each grounding wire is properly secured.
- Check that each connector is engaged securely.

EMU29120

## Exhaust leakage

Start the engine and check that no exhaust leaks from the joints between the exhaust cover, cylinder head, and body cylinder.

EMU29130

## Water leakage

Start the engine and check that no water leaks from the joints between the exhaust cover, cylinder head, and body cylinder.

EMU29140

## Engine oil leakage

Check for oil leaks on the around the engine.

## NOTE:

If any leaks are found, consult your Yamaha dealer.

EMU29154

## Checking power trim and tilt system

EWM00431

## WARNING

- Never get under the lower unit while it is tilted, even when the tilt support lever is locked. Severe injury could occur if the outboard motor accidentally falls.
- Make sure no one is under the outboard motor before performing this test. Body parts can be crushed between the motor and the clamp bracket when the motor is trimmed or tilted.

1. Check the power trim and tilt unit for any sign of oil leaks.
2. Operate each of the power trim and tilt switches on the remote control and engine bottom cowling (if equipped) to check that all switches work.
3. Tilt the outboard motor up and check that the tilt rod and trim rods are extended completely.

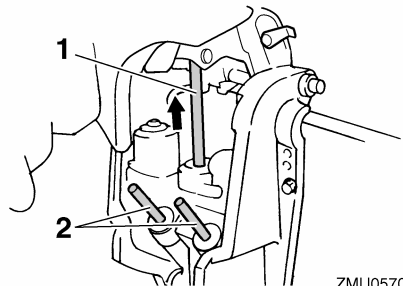

1. Tilt rod
  2. Trim rods
4. Use the tilt support lever to lock the motor in the up position. Operate the tilt down switch briefly so the motor is supported by the tilt support lever.

# Maintenance

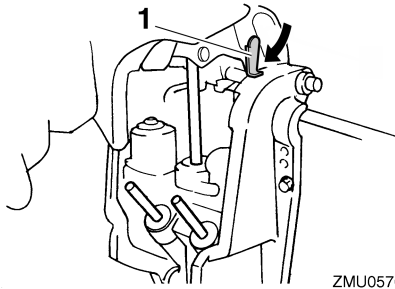

ZMU05705

1. Tilt support lever
5. Check that the tilt rod and trim rods are free of corrosion or other flaws.
6. Activate the tilt-down switch until the trim rods have retracted completely into the cylinders.

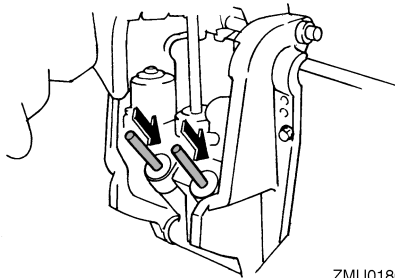

ZMU01800

7. Activate the trim-up switch until the tilt rod is fully extended. Unlock the tilt support lever.
8. Tilt the outboard motor down. Check that the tilt rod and trim rods operate smoothly.

## NOTE:

Consult your Yamaha dealer if any operation is abnormal.

EMU32110

## Checking propeller

EWM01610

### WARNING

You could be seriously injured if the engine accidentally starts when you are near the propeller.

- Before inspecting, removing, or installing the propeller, remove the spark plug caps from the spark plugs. Also, place the shift control in neutral, turn the main switch to “OFF” (off) and remove the key, and remove the cord from the engine shut-off switch. Turn off the battery cut-off switch if your boat has one.
- Do not use your hand to hold the propeller when loosening or tightening the propeller nut. Put a wood block between the anti-cavitation plate and the propeller to prevent the propeller from turning.

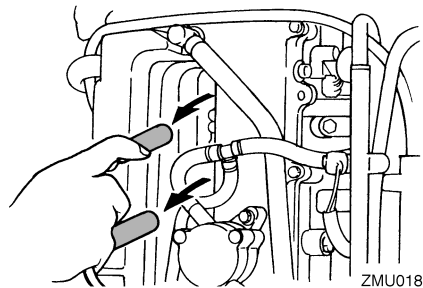

ZMU01801

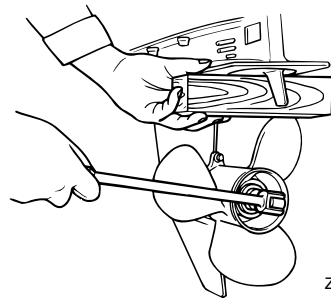

ZMU01897

## Checkpoints

- Check each of the propeller blades for wear, erosion from cavitation or ventilation, or other damage.
- Check the propeller shaft for damage.
- Check the splines for wear or damage.
- Check for fish line tangled around the propeller shaft.

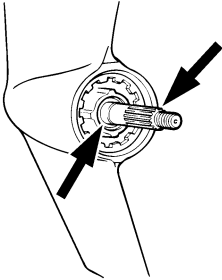

ZMU01803

- Check the propeller shaft oil seal for damage.

EMU30661

## Removing propeller

EMU29196

### Spline models

1. Straighten the cotter pin and pull it out using a pair of pliers.
2. Remove the propeller nut, washer, and spacer (if equipped).

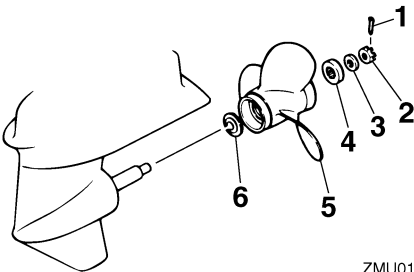

ZMU01804

1. Cotter pin
2. Propeller nut
3. Washer
4. Spacer
5. Propeller
6. Thrust washer

3. Remove the propeller, washer (if equipped), and thrust washer.

EMU30671

## Installing propeller

EMU29242

### Spline models

EWM00770



**WARNING**

On counter rotation models, be sure to use a propeller intended for counterclockwise rotation. These propellers are identified with the letter "L" after the size indication on the propeller. Otherwise the boat could move in the opposite direction from that expected.

ECM00340

## CAUTION:

- Be sure to install the thrust washer before installing the propeller, otherwise the lower case and propeller boss could be damaged.
- Be sure to use a new cotter pin and bend the ends over securely. Otherwise the propeller could come off during operation and be lost.

1. Apply Yamaha marine grease or a corrosion resistant grease to the propeller shaft.
2. Install the thrust washer and propeller on the propeller shaft.
3. Install the spacer and washer. Tighten the propeller nut to the specified torque.

Propeller nut tightening torque:  
55.0 Nm (40.6 ft-lb) (5.61 kgf-m)

4. Align the propeller nut with the propeller shaft hole. Insert a new cotter pin in the hole and bend the cotter pin ends.

# Maintenance

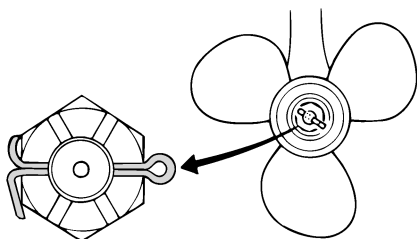

ZMU01805

## NOTE:

If the propeller nut does not align with the propeller shaft hole after tightening to the specified torque, tighten the nut further to align it with the hole.

EMU29283

## Changing gear oil

EWM00800

### WARNING

- Be sure the outboard motor is securely fastened to the transom or a stable stand. You could be severely injured if the outboard motor falls on you.
- Never get under the lower unit while it is tilted, even when the tilt support lever or knob is locked. Severe injury could occur if the outboard motor accidentally falls.

1. Tilt the outboard motor so that the gear oil drain screw is at the lowest point possible.
2. Place a suitable container under the gear case.
3. Remove the gear oil drain screw and gasket.

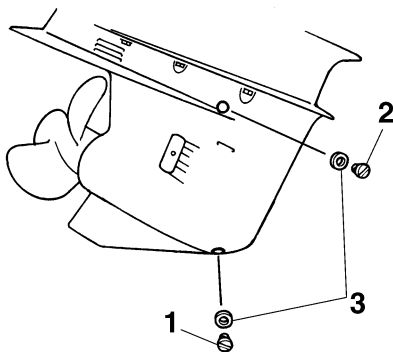

ZMU01806

1. Gear oil drain screw
2. Oil level plug
3. Gasket

## NOTE:

- If a magnetic gear oil drain screw is equipped, remove all metal particles from the screw before installing it.
- Always use new gaskets. Do not reuse the removed gaskets.

4. Remove the oil level plug and gasket to allow the oil to drain completely.

ECM00710

### CAUTION:

**Inspect the used oil after it has been drained. If the oil is milky, water is getting into the gear case which can cause gear damage. Consult a Yamaha dealer for repair of the lower unit seals.**

## NOTE:

For disposal of used oil, consult your Yamaha dealer.



5. With the outboard motor in a vertical position, and using a flexible or pressurized filling device, inject the gear oil into the gear oil drain screw hole.

Recommended gear oil:  
Hypoid gear oil SAE#90  
Gear oil quantity:  
F150AET 980.0 cm<sup>3</sup> (33.13 US oz)  
(34.56 Imp.oz)  
FL150AET 870.0 cm<sup>3</sup> (29.41 US oz)  
(30.68 Imp.oz)

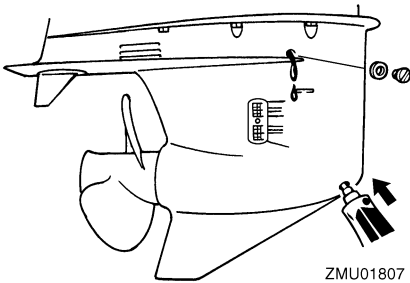

6. Put a new gasket on the oil level plug. When the oil begins to flow out of the oil level plug hole, insert and tighten the oil level plug.

Tightening torque:  
9.0 Nm (6.6 ft-lb) (0.92 kgf-m)

7. Put a new gasket on the gear oil drain screw. Insert and tighten the gear oil drain screw.

Tightening torque:  
9.0 Nm (6.6 ft-lb) (0.92 kgf-m)

EMU29312

## Inspecting and replacing anode(s)

Yamaha outboard motors are protected from corrosion by sacrificial anodes. Inspect the external anodes periodically. Remove scales

from the surfaces of the anodes. Consult a Yamaha dealer for replacement of external anodes.

ECM00720

### CAUTION:

**Do not paint anodes, as this would render them ineffective.**

### NOTE:

Inspect ground leads attached to external anodes on equipped models. Consult a Yamaha dealer for inspection and replacement of internal anodes attached to the power unit.

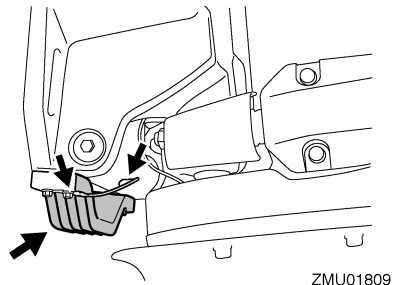
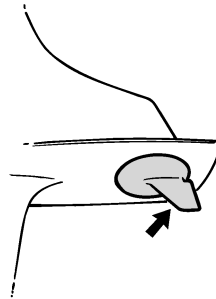

EMU29320

## Checking battery (for electric start models)

EWM00330

### WARNING

**Battery electrolytic fluid is dangerous; it contains sulfuric acid and therefore is poisonous and highly caustic.**

# Maintenance

---

Always follow these preventive measures:

- Avoid bodily contact with electrolytic fluid as it can cause severe burns or permanent eye injury.
- Wear protective eye gear when handling or working near batteries.

Antidote (EXTERNAL):

- SKIN - Flush with water.
- EYES - Flush with water for 15 minutes and get immediate medical attention.

Antidote (INTERNAL):

- Drink large quantities of water or milk followed by milk of magnesia, beaten egg, or vegetable oil. Get immediate medical attention.

Batteries also generate explosive hydrogen gas; therefore, you should always follow these preventive measures:

- Charge batteries in a well-ventilated area.
- Keep batteries away from fire, sparks, or open flames (for example: welding equipment, lighted cigarettes, and so on.)
- DO NOT SMOKE when charging or handling batteries.

**KEEP BATTERIES AND ELECTROLYTIC FLUID OUT OF REACH OF CHILDREN.**

---

ECM00360

**CAUTION:** \_\_\_\_\_

- A poorly maintained battery will quickly deteriorate.
  - Ordinary tap water contains minerals harmful to a battery, and should not be used for topping up.
- 

1. Check the electrolyte level at least once a month. Fill to the manufacturer's recommended level when necessary. Top up only with distilled water (or pure de-ionized water suitable to use in batteries).

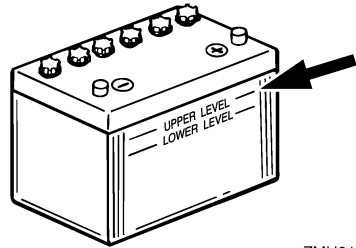

ZMU01810

2. Always keep the battery in a good state of charge. Installing a voltmeter will help you monitor your battery. If you will not use the boat for a month or more, remove the battery from the boat and store it in a cool, dark place. Completely recharge the battery before using it.
3. If the battery will be stored for longer than a month, check the specific gravity of the fluid at least once a month and recharge the battery when it is low.

**NOTE:** \_\_\_\_\_

Consult a Yamaha dealer when charging or re-charging batteries.

---

EMU30052

**Connecting the battery**

EWM00570



**WARNING** \_\_\_\_\_

Mount the battery holder securely in a dry, well-ventilated, vibration-free location in the boat. Install a fully charged battery in the holder.

---

ECM01122

**CAUTION:** \_\_\_\_\_

- Make sure the main switch (on applicable models) is "OFF" (off) before working on the battery.
- Reversal of the battery cables will damage the electrical parts.

- Connect the red battery cable first when installing the battery and disconnect the black battery cable first when removing it.
- The electrical contacts of the battery and cables must be clean and properly connected, or the battery will not start the engine.

Connect the RED battery cable to the POSITIVE (+) terminal first. Then connect the BLACK battery cable to the NEGATIVE (-) terminal.

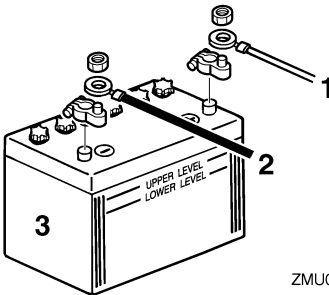

ZMU04407

1. Red cable
2. Black cable
3. Battery

### Connecting an accessory battery (optional)

1. Remove the accessory battery coupler cover from the outboard motor.
2. Connect the accessory battery coupler to the coupler of the accessory battery cable (optional). Use a connecting cable between the (-) terminals of the starting battery and accessory battery. See the illustrations of the wiring connections. This cable must be made from wire thicker than the starting battery cable.

EWM00600



**Use of smaller wire could lead to a fire.**

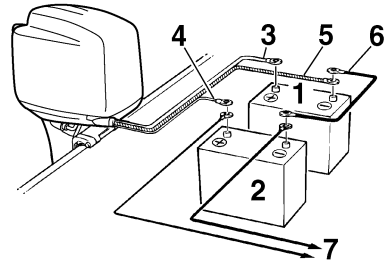

ZMU01839

1. Battery for starting
2. Battery for accessories
3. Large red lead for starting battery
4. Small red lead for accessory battery charging (optional part)
5. Large black lead
6. Negative connecting cable
7. Power for accessories

### **NOTE:**

If connecting an accessory battery, consult your Yamaha dealer about correct wiring.

EMU29370

### **Disconnecting the battery**

Disconnect the BLACK cable from the NEGATIVE (-) terminal first. Then disconnect the RED cable from the POSITIVE (+) terminal.

EMU29391

### **Checking top cowling**

ECM01650

### **CAUTION:**

**Be sure the cowling is closed securely and that there are no gaps. A loose or improperly fitting cover could allow water into the engine.**

Check the fitting of the top cowling by pushing it with both hands. If it is loose have it repaired by your Yamaha dealer.

# Maintenance

---

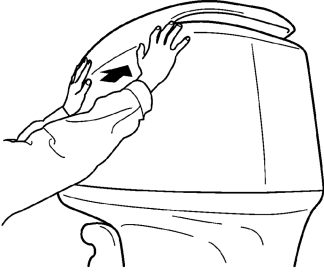

ZMU01812

EMU29400

## Coating the boat bottom

A clean hull improves boat performance. The boat bottom should be kept as clean of marine growth as possible. If necessary, the boat bottom can be coated with an anti-fouling paint approved for your area to inhibit marine growth.

Do not use anti-fouling paint which includes copper or graphite. These paints can cause more rapid engine corrosion.

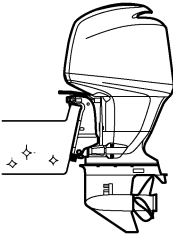

ZMU01813

EMU29425

## Troubleshooting

A problem in the fuel, compression, or ignition systems can cause poor starting, loss of power, or other problems. This section describes basic checks and possible remedies, and covers all Yamaha outboard motors. Therefore some items may not apply to your model.

If your outboard motor requires repair, bring it to your Yamaha dealer.

If the engine trouble-warning indicator is flashing, consult your Yamaha dealer.

### **Starter will not operate.**

Q. Is battery capacity weak or low?

A. Check battery condition. Use battery of recommended capacity.

Q. Are battery connections loose or corroded?

A. Tighten battery cables and clean battery terminals.

Q. Is fuse for electric start relay or electric circuit blown?

A. Check for cause of electric overload and repair. Replace fuse with one of correct amperage.

Q. Are starter components faulty?

A. Have serviced by a Yamaha dealer.

Q. Is shift lever in gear?

A. Shift to neutral.

### **Engine will not start (starter operates).**

Q. Is fuel tank empty?

A. Fill tank with clean, fresh fuel.

Q. Is fuel contaminated or stale?

A. Fill tank with clean, fresh fuel.

Q. Is fuel filter clogged?

A. Clean or replace filter.

Q. Is starting procedure incorrect?

A. See page 38.

Q. Has fuel pump malfunctioned?

A. Have serviced by a Yamaha dealer.

Q. Are spark plug(s) fouled or of incorrect type?

A. Inspect spark plug(s). Clean or replace with recommended type.

Q. Are spark plug cap(s) fitted incorrectly?

A. Check and re-fit cap(s).

Q. Is ignition wiring damaged or poorly connected?

A. Check wires for wear or breaks. Tighten all loose connections. Replace worn or broken wires.

Q. Are ignition parts faulty?

A. Have serviced by a Yamaha dealer.

Q. Is engine shut-off cord not attached?

A. Attach cord.

Q. Are engine inner parts damaged?

A. Have serviced by a Yamaha dealer.

### **Engine idles irregularly or stalls.**

Q. Are spark plug(s) fouled or of incorrect type?

A. Inspect spark plug(s). Clean or replace with recommended type.

Q. Is fuel system obstructed?

# Trouble Recovery

---

A. Check for pinched or kinked fuel line or other obstructions in fuel system.

Q. Is fuel contaminated or stale?

A. Fill tank with clean, fresh fuel.

Q. Is fuel filter clogged?

A. Clean or replace filter.

Q. Have ignition parts failed?

A. Have serviced by a Yamaha dealer.

Q. Has warning system activated?

A. Find and correct cause of warning.

Q. Is spark plug gap incorrect?

A. Inspect and adjust as specified.

Q. Is ignition wiring damaged or poorly connected?

A. Check wires for wear or breaks. Tighten all loose connections. Replace worn or broken wires.

Q. Is specified engine oil not being used?

A. Check and replace oil as specified.

Q. Is thermostat faulty or clogged?

A. Have serviced by a Yamaha dealer.

Q. Are carburetor adjustments incorrect?

A. Have serviced by a Yamaha dealer.

Q. Is fuel pump damaged?

A. Have serviced by a Yamaha dealer.

Q. Is air vent screw on fuel tank closed?

A. Open air vent screw.

Q. Is choke knob pulled out?

A. Return to home position.

Q. Is motor angle too high?

A. Return to normal operating position.

Q. Is carburetor clogged?

A. Have serviced by a Yamaha dealer.

Q. Is fuel joint connection incorrect?

A. Connect correctly.

Q. Is throttle valve adjustment incorrect?

A. Have serviced by a Yamaha dealer.

Q. Is battery cable disconnected?

A. Connect securely.

## **Warning buzzer sounds or indicator lights.**

Q. Is cooling system clogged?

A. Check water intake for restriction.

Q. Is engine oil level low?

A. Fill oil tank with specified engine oil.

Q. Is heat range of spark plug incorrect?

A. Inspect spark plug and replace it with recommended type.

Q. Is specified engine oil not being used?

A. Check and replace oil with specified type.

Q. Is engine oil contaminated or deteriorated?

A. Replace oil with fresh, specified type.

Q. Is oil filter clogged?

A. Have serviced by a Yamaha dealer.

Q. Has oil feed/injection pump malfunctioned?

A. Have serviced by a Yamaha dealer.

# Trouble Recovery

---

Q. Is load on boat improperly distributed?

A. Distribute load to place boat on an even plane.

Q. Is water pump or thermostat faulty?

A. Have serviced by a Yamaha dealer.

Q. Is there excess water in fuel filter cup?

A. Drain filter cup.

## Engine power loss.

Q. Is propeller damaged?

A. Have propeller repaired or replaced.

Q. Is propeller pitch or diameter incorrect?

A. Install correct propeller to operate outboard at its recommended speed (r/min) range.

Q. Is trim angle incorrect?

A. Adjust trim angle to achieve most efficient operation.

Q. Is motor mounted at incorrect height on transom?

A. Have motor adjusted to proper transom height.

Q. Has warning system activated?

A. Find and correct cause of warning.

Q. Is boat bottom fouled with marine growth?

A. Clean boat bottom.

Q. Are spark plug(s) fouled or of incorrect type?

A. Inspect spark plug(s). Clean or replace with recommended type.

Q. Are weeds or other foreign matter tangled on gear housing?

A. Remove foreign matter and clean lower unit.

Q. Is fuel system obstructed?

A. Check for pinched or kinked fuel line or other obstructions in fuel system.

Q. Is fuel filter clogged?

A. Clean or replace filter.

Q. Is fuel contaminated or stale?

A. Fill tank with clean, fresh fuel.

Q. Is spark plug gap incorrect?

A. Inspect and adjust as specified.

Q. Is ignition wiring damaged or poorly connected?

A. Check wires for wear or breaks. Tighten all loose connections. Replace worn or broken wires.

Q. Have electrical parts failed?

A. Have serviced by a Yamaha dealer.

Q. Is specified fuel not being used?

A. Replace fuel with specified type.

Q. Is specified engine oil not being used?

A. Check and replace oil with specified type.

Q. Is thermostat faulty or clogged?

A. Have serviced by a Yamaha dealer.

Q. Is air vent screw closed?

A. Open the air vent screw.

Q. Is fuel pump damaged?

A. Have serviced by a Yamaha dealer.

Q. Is fuel joint connection incorrect?

# Trouble Recovery

---

A. Connect correctly.

Q. Is heat range of spark plug incorrect?

A. Inspect spark plug and replace it with recommended type.

Q. Is high pressure fuel pump drive belt broken?

A. Have serviced by a Yamaha dealer.

Q. Is engine not responding properly to shift lever position?

A. Have serviced by a Yamaha dealer.

## Engine vibrates excessively.

Q. Is propeller damaged?

A. Have propeller repaired or replaced.

Q. Is propeller shaft damaged?

A. Have serviced by a Yamaha dealer.

Q. Are weeds or other foreign matter tangled on propeller?

A. Remove and clean propeller.

Q. Is motor mounting bolt loose?

A. Tighten bolt.

Q. Is steering pivot loose or damaged?

A. Tighten or have serviced by a Yamaha dealer.

EMU29433

## Temporary action in emergency

EMU29440

### Impact damage

EWM00870

#### **WARNING**

**The outboard motor can be seriously damaged by a collision while operating or trailering. Damage could make the outboard motor unsafe to operate.**

---

If the outboard motor hits an object in the water, follow the procedure below.



1. Stop the engine immediately.
2. Inspect the control system and all components for damage. Also inspect the boat for damage.
3. Whether damage is found or not, return to the nearest harbor slowly and carefully.
4. Have a Yamaha dealer inspect the outboard motor before operating it again.

EMU29452

## Running single engine (twin engines)

When using only one engine in an emergency, be sure to keep the unused one tilted up and operate the other engine at low speed.

ECM00370

#### **CAUTION:** \_\_\_\_\_

**If the boat is operated with one engine in the water but not running, water may run into the exhaust pipe due to wave action, causing engine trouble.**

---

#### **NOTE:** \_\_\_\_\_

When you are maneuvering at low speed, such as near a dock, it is recommended that both engines be running with one in neutral gear if possible.

---



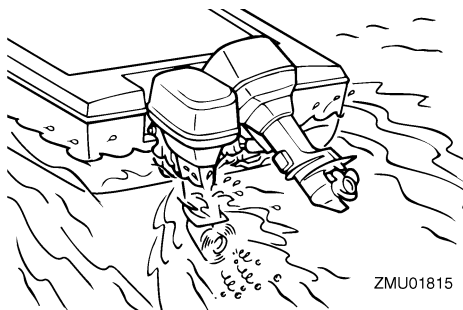

EMU29471

## Replacing fuse

If a fuse has blown, remove the electrical cover, open the fuse holder and remove the fuse with a fuse puller (if equipped). Replace it with a spare one of the proper amperage.

EWM00630

### **WARNING**

**Be sure to use the specified fuse. An incorrect fuse or a piece of wire could allow excessive current flow. This could cause electric system damage and a fire hazard.**

### **NOTE:**

Consult your Yamaha dealer if the new fuse immediately blows again.

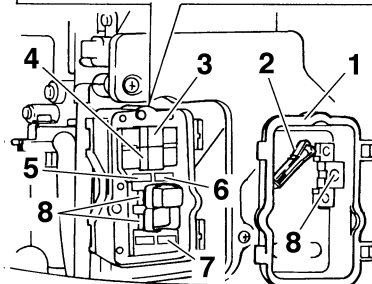
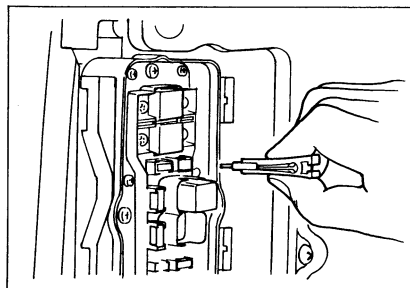

1. Electrical cover
2. Fuse puller
3. Isolator fuse (50 A)
4. Main fuse (50 A)
5. Main switch / trim switch fuse (20 A)
6. Engine control unit / ignition coil / electric fuel pump / fuel injector / ISC (idle speed control) fuse (20 A)
7. Starter relay fuse (30 A)
8. Spare fuse (20 A, 30 A, 50 A)

EMU29523

## Power trim and tilt will not operate

If the engine cannot be tilted up or down with the power trim and tilt because of a discharged battery or a failure with the power trim and tilt unit, the engine can be tilted manually.

1. Loosen the manual valve screw by turning it counterclockwise until it stops.

# Trouble Recovery

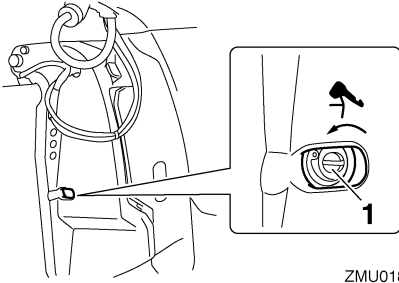

ZMU01817

1. Manual valve screw
2. Put the engine in the desired position, then tighten the manual valve screw by turning it clockwise.

EMU31592

## Water separator-warning indicator blinks while cruising

EWM01500

### **WARNING**

Gasoline is highly flammable, and its vapors are flammable and explosive.

- Do not perform this procedure on a hot or running engine. Allow the engine to cool.
- There will be fuel in the fuel filter. Keep away from sparks, cigarettes, flames or other sources of ignition.
- This procedure will allow some fuel to spill. Catch fuel in a rag. Wipe up any spilled fuel immediately.
- The fuel filter must be reassembled carefully with the O-ring, filter cup, and hoses in place. Improper assembly or replacement could result in a fuel leak, which could result in a fire or explosion hazard.

If the water separator-warning indicator on the Command Link tachometer blinks, perform the following procedure.

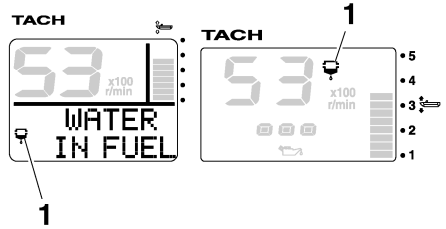

ZMU05442

1. Water separator-warning indicator
1. Stop the engine.
2. Remove the top cowling.
3. Remove the holder.

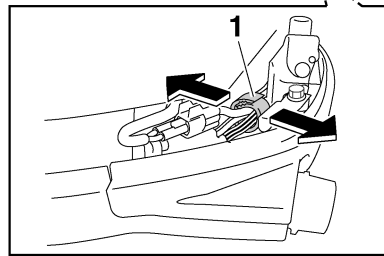
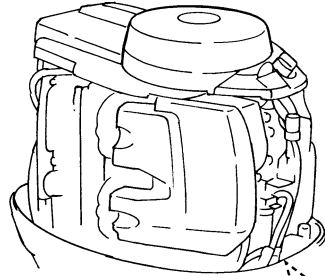

ZMU05754

1. Holder
4. Disconnect the water detection switch coupler.

# Trouble Recovery

ECM01570

## CAUTION:

Be careful not to get any water on the water detection switch coupler, otherwise a malfunction could occur.

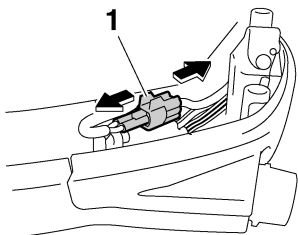

ZMU05456

1. Water detection switch coupler
5. Unscrew the filter cup from the filter housing.

## NOTE:

Be careful not to twist the water detection switch lead when unscrewing the filter cup.

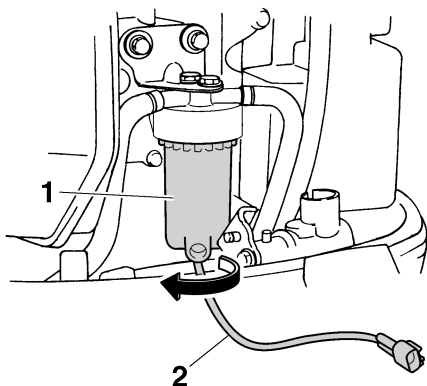

ZMU05457

1. Filter cup
2. Water detection switch lead
6. Drain the water in the filter cup by soaking it up with a rag.

**NOTE:** Properly dispose of the rag.

7. Firmly screw the filter cup onto the filter housing.

**NOTE:** Be careful not to twist the water detection switch lead when screwing the filter cup onto the filter housing.

8. Connect the water detection switch coupler securely until a click is heard.

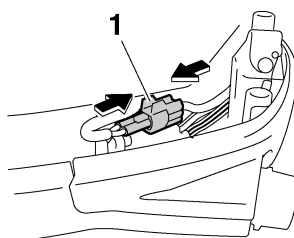

ZMU05458

1. Water detection switch coupler
9. Fasten the water detection switch lead with the holder.

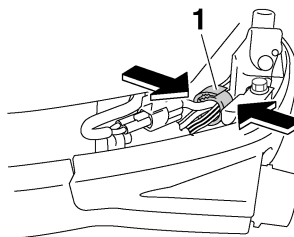

ZMU05755

1. Holder
10. Install the top cowling.
11. Start the engine and make sure that the water separator-warning indicator remains off.

# Trouble Recovery

---

**NOTE:** \_\_\_\_\_

Have a Yamaha dealer inspect the outboard motor after returning to port.

---

EMU33500

**Treatment of submerged motor**

If the outboard motor is submerged, immediately take it to a Yamaha dealer. Otherwise some corrosion may begin almost immediately.

ECM00400

**CAUTION:** \_\_\_\_\_

**Do not attempt to run the outboard motor until it has been completely inspected.**

---





YAMAHA MOTOR CO., LTD.

Printed in Japan

October 2007-1.9 × 1 CR

Printed on recycled paper