



**YAMAHA**



**Z250F**

**OWNER'S MANUAL**

**60V-28199-76-E0**

## **CAUTION**

### **USE UNLEADED STRAIGHT GASOLINE ONLY**

- Gasoline containing lead can cause performance loss and engine damage.
- Do not use gasoline mixed with oil during the break-in period or any time afterwards.

**YAMALUBE 2 STROKE OUTBOARD OIL IS  
RECOMMENDED**

ZMU01841

**Read this owner's manual carefully before operating your outboard motor.**

# Important manual information

EMU25101

## To the owner

Thank you for choosing a Yamaha outboard motor. This Owner's Manual contains information needed for proper operation, maintenance and care. A thorough understanding of these simple instructions will help you obtain maximum enjoyment from your new Yamaha. If you have any question about the operation or maintenance of your outboard motor, please consult a Yamaha dealer.

In this Owner's Manual particularly important information is distinguished in the following ways.



The Safety Alert Symbol means **ATTENTION! BECOME ALERT! YOUR SAFETY IS INVOLVED!**

EWM00780



### **WARNING**

**Failure to follow WARNING instructions could result in severe injury or death to the machine operator, a bystander, or a person inspecting or repairing the outboard motor.**

ECM00700

### **CAUTION:**

**A CAUTION indicates special precautions that must be taken to avoid damage to the outboard motor.**

### **NOTE:**

A NOTE provides key information to make procedures easier or clearer.

Yamaha continually seeks advancements in product design and quality. Therefore, while this manual contains the most current product information available at the time of printing, there may be minor discrepancies between your machine and this manual. If there is any question concerning this manu-

al, please consult your Yamaha dealer.

To ensure long product life, Yamaha recommends that you use the product and perform the specified periodic inspections and maintenance by correctly following the instructions in the owner's manual. Note that if you do not follow these instructions, not only may the product break down, but the warranty will also be voided.

Some countries have laws or regulations restricting users from taking the product out of the country where it was purchased, and it may be impossible to register the product in the destination country. Additionally, the warranty may not apply in certain regions. When planning to take the product to another country, consult the dealer where the product was purchased for further information.

If the product was purchased used, please consult your closest dealer for customer re-registration, and to be eligible for the specified services.

### **NOTE:**

The Z250FETO and the standard accessories are used as a base for the explanations and illustrations in this manual. Therefore some items may not apply to every model.

EMU25120

### **Z250F**

#### **OWNER'S MANUAL**

©2006 by Yamaha Motor Co., Ltd.

1st Edition, March 2006

All rights reserved.

**Any reprinting or unauthorized use without the written permission of**

**Yamaha Motor Co., Ltd.**

**is expressly prohibited.**

**Printed in Japan**

# Table of contents

---

<b>General information</b> .....	<b>1</b>	Fuel warning indicator .....	17
Identification numbers record .....	1	Low battery voltage warning indicator .....	17
Outboard motor serial number .....	1	6Y8 Multifunction meters .....	17
Key number .....	1	Tachometer unit .....	17
EC label .....	1	Speed & fuel meter unit .....	21
Safety information .....	2	Speedometer unit .....	22
Important labels .....	3	Fuel management meter .....	23
Warning labels .....	3	<b>Warning system</b> .....	<b>23</b>
Caution labels .....	4	Overheat warning .....	23
Fueling instructions .....	4	Oil level warning and oil filter clogging warning .....	24
Gasoline .....	4	<b>Operation</b> .....	<b>26</b>
Engine oil .....	4	Installation .....	26
Battery requirement .....	5	Mounting the outboard motor .....	26
Battery specifications .....	5	Breaking in engine .....	27
Propeller selection .....	5	Procedure for HPDI models .....	27
Start-in-gear protection .....	6	Preoperation checks .....	28
<b>Basic components</b> .....	<b>7</b>	Fuel .....	28
Main components .....	7	Oil .....	28
Remote control .....	8	Controls .....	28
Remote control lever .....	9	Engine .....	28
Neutral interlock trigger .....	9	Operation after a long period of storage .....	28
Neutral throttle lever .....	9	Filling fuel and engine oil .....	30
Throttle friction adjuster .....	9	Filling fuel for models without a fuel joint .....	30
Engine stop lanyard switch .....	10	Filling oil for oil injection models .....	30
Main switch .....	10	Oil level indicator operation .....	31
Power trim and tilt switch on remote control or tiller handle .....	11	Operating engine .....	32
Power trim and tilt switch on bottom engine cowling .....	11	Feeding fuel .....	32
Trim tab with anode .....	11	Starting engine .....	32
Tilt support lever for power trim and tilt or hydro tilt model .....	12	Warming up engine .....	33
Top cowling lock levers .....	12	Electric start and prime start models .....	33
Flushing device .....	13	Shifting .....	34
Water separator .....	13	Forward (tiller handle and remote control models) .....	34
Digital tachometer .....	13	Reverse (automatic reverse lock and power trim and tilt models) .....	34
Oil level indicator (digital type) .....	14	Stopping engine .....	35
Overheat warning indicator (digital type) .....	14	Procedure .....	35
Speedometer (digital type) .....	14	Trimming outboard motor .....	35
Trim meter (digital type) .....	15	Adjusting trim angle .....	36
Hour meter (digital type) .....	15	Adjusting boat trim .....	36
Trip meter .....	16		
Clock .....	16		
Fuel gauge .....	16		

# Table of contents

Tilting up and down .....	37	models) .....	56
Procedure for tilting up (power trim and tilt models / power tilt models) .....	38	Connecting the Battery .....	57
Procedure for tilting down (power trim and tilt models / power tilt models) .....	39	Disconnecting the battery .....	58
Cruising in shallow water .....	39	Checking top cowling .....	58
Power trim and tilt models / power tilt models .....	39	Coating the boat bottom .....	59
Cruising in other conditions .....	40	<b>Trouble Recovery .....</b>	<b>60</b>
<b>Maintenance .....</b>	<b>41</b>	Troubleshooting .....	60
Specifications .....	41	Temporary action in emergency ...	63
Transporting and storing outboard motor .....	42	Impact damage .....	63
Storing outboard motor .....	42	Replacing fuse .....	63
Procedure .....	43	Power trim and tilt / power tilt will not operate .....	64
Lubrication (oil injection models) .....	43	Water separator warning indicator blinks while cruising .....	64
Battery care .....	44	Engine fails to operate .....	66
Flushing power unit .....	44	Low oil level warning activates .....	66
Cleaning the outboard motor .....	45	Treatment of submerged motor ....	67
Checking painted surface of motor .....	45	Procedure .....	67
Periodic maintenance .....	46		
Replacement parts .....	46		
Maintenance chart .....	47		
Maintenance chart (additional) .....	48		
Greasing .....	49		
Cleaning and adjusting spark plug .....	49		
Checking fuel system .....	50		
Inspecting idling speed .....	51		
Checking water in engine oil tank ...	52		
Checking wiring and connectors .....	52		
Exhaust leakage .....	52		
Water leakage .....	52		
Checking power trim and tilt system .....	52		
Checking propeller .....	53		
Removing the propeller .....	54		
Installing the Propeller .....	54		
Changing gear oil .....	55		
Inspecting and replacing anode(s) .....	56		
Checking battery (for electric start			

# General information

EMU25170

## Identification numbers record

EMU25183

### Outboard motor serial number

The outboard motor serial number is stamped on the label attached to the port side of the clamp bracket.

Record your outboard motor serial number in the spaces provided to assist you in ordering spare parts from your Yamaha dealer or for reference in case your outboard motor is stolen.

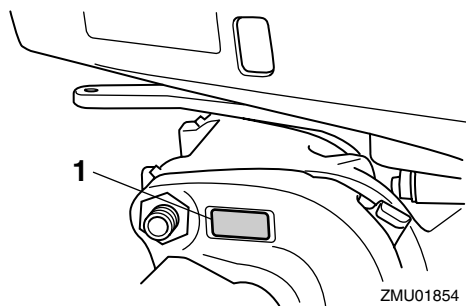

ZMU01854

1. Outboard motor serial number location

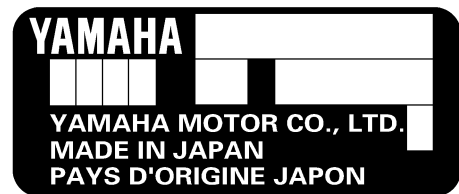

ZMU01692

EMU25190

### Key number

If a main key switch is equipped with the motor, the key identification number is stamped on your key as shown in the illustration. Record this number in the space provided for reference in case you need a new key.

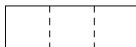

ZMU01693

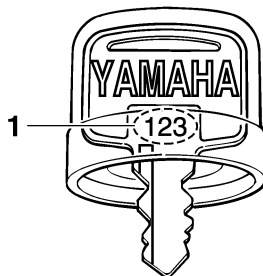

ZMU01694

1. Key number

EMU25202

### EC label

Engines affixed with this label conform to certain portions of the European Parliament directive relating to machinery. Refer to the label and the EC Declaration of Conformity for more details.

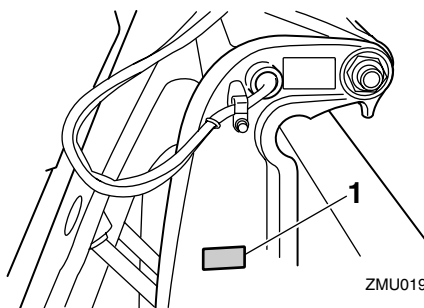

ZMU01947

1. EC label location

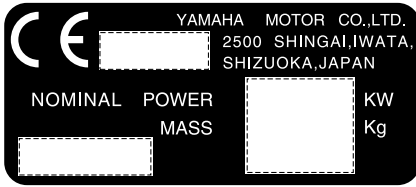

ZMU01696

EMU25371

## Safety information

- Before mounting or operating the outboard motor, read this entire manual. Reading it should give you an understanding of the motor and its operation.
- Before operating the boat, read any owner's or operator's manuals supplied with it and all labels. Be sure you understand each item before operating.
- Do not overpower the boat with this outboard motor. Overpowering the boat could result in loss of control. The rated power of the outboard should be equal to or less than the rated horsepower capacity of the boat. If the rated horsepower capacity of the boat is unknown, consult the dealer or boat manufacturer.
- Do not modify the outboard. Modifications could make the motor unfit or unsafe to use.
- Incorrect propeller selection and incorrect use may not only cause engine damage, but also adversely affect fuel consumption. Consult your dealer for correct use.
- Never operate after drinking alcohol or taking drugs. About 50% of all boating fatalities involve intoxication.
- Have an approved personal flotation device (PFD) on board for every occupant. It is a good idea to wear a PFD whenever boating. At a minimum, children and non-swimmers should always wear PFDs, and everyone should wear PFDs when there are potentially hazardous boating conditions.
- Gasoline is highly flammable, and its vapors are flammable and explosive. Handle and store gasoline carefully. Make sure there are no gas fumes or leaking fuel before starting the engine.
- This product emits exhaust gases which contain carbon monoxide, a colorless, odorless gas which may cause brain damage or death when inhaled. Symptoms include nausea, dizziness, and drowsiness. Keep cockpit and cabin areas well ventilated. Avoid blocking exhaust outlets.
- Check throttle, shift, and steering for proper operation before starting the engine.
- Attach the engine stop switch lanyard to a secure place on your clothing, or your arm or leg while operating. If you accidentally leave the helm, the lanyard will pull from the switch, stopping the engine.
- Know the marine laws and regulations where you will be boating - and obey them.
- Stay informed about the weather. Check weather forecasts before boating. Avoid boating in hazardous weather.
- Tell someone where you are going: leave a Float Plan with a responsible person. Be sure to cancel the Float Plan when you return.
- Use common sense and good judgment when boating. Know your abilities, and be sure you understand how your boat handles under the different boating conditions you may encounter. Operate within your limits, and the limits of your boat. Always operate at safe speeds, and keep a careful

# General information

---

watch for obstacles and other traffic.

- Always watch carefully for swimmers during the engine operation.
- Stay away from swimming areas.
- When a swimmer is in the water near you shift into neutral and shut off the engine.
- Do not illegally discard empty containers used to replace or replenish oil. For the correct processing of empty containers, consult the dealer where you purchased the oil.
- When replacing oils used to lubricate the product (engine or gear oil), be sure to wipe away any spilt oil. Never pour oil without using a funnel or similar device. If necessary, verify the necessary replacement procedure with the dealer.
- Never illegally discard (dump) the product. Yamaha recommends consulting the dealer on discarding the product.

EMU25382

## Important labels

EMU25395

### Warning labels

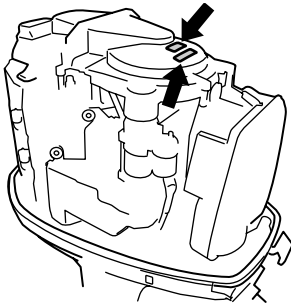

ZMU01858

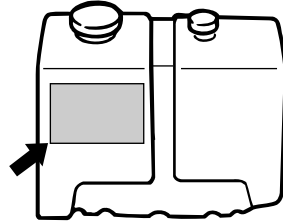

ZMU01948

EMU25401

### Label

EWM01260

#### **WARNING**

- Be sure shift control is in neutral before starting engine. (except 2HP)
- Do not touch or remove electrical parts when starting or during operation.
- Keep hands, hair, and clothes away from flywheel and other rotating parts while engine is running.

EMU25451

### Label

ENGINE OIL ONLY

- Pour the engine oil into this oil tank, not gasoline.

RECOMMENDED OIL:

YAMALUBE 2 STROKE OUTBOARD OIL or an equivalent TC-W3 certified outboard oil.

EWM01270

#### **WARNING**

**Do not add gasoline to the oil tank. Fire explosion could result.**

---



EMU25465

## Caution labels

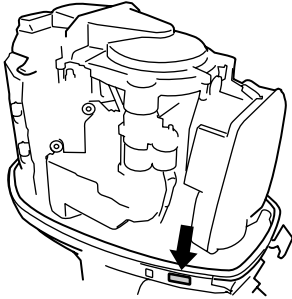

ZMU01949

EMU30690

## Label

ECM01480

### **CAUTION:**

#### **USE UNLEADED STRAIGHT GASOLINE ONLY**

- Gasoline containing lead can cause performance loss and engine damage.
- Do not use gasoline mixed with oil (pre-mix).
- Recommended engine oil: YAMALUBE 2-stroke outboard oil.

Refer to Owner's manual.

EMU25540

## Fueling instructions

EWM00010

### **WARNING**

#### **GASOLINE AND ITS VAPORS ARE HIGHLY FLAMMABLE AND EXPLOSIVE!**

- Do not smoke when refueling, and keep away from sparks, flames, or other sources of ignition.
- Stop engine before refueling.
- Refuel in a well-ventilated area. Refuel portable fuel tanks off the boat.
- Take care not to spill gasoline. If gasoline spills, wipe it up immediately with

dry rags.

- Do not overfill the fuel tank.
- Tighten the filler cap securely after refueling.
- If you should swallow some gasoline, inhale a lot of gasoline vapor, or get gasoline in your eyes, get immediate medical attention.
- If any gasoline spills onto your skin, immediately wash with soap and water. Change clothing if gasoline spills on it.
- Touch the fuel nozzle to the filler opening or funnel to help prevent electrostatic sparks.

ECM00010

### **CAUTION:**

Use only new clean gasoline which has been stored in clean containers and is not contaminated with water or foreign matter.

EMU25580

## Gasoline

Recommended gasoline:

Regular unleaded gasoline with a minimum octane rating of 90 (Research Octane Number).

If knocking or pinging occurs, use a different brand of gasoline or premium unleaded fuel.

EMU25670

## Engine oil

Yamalube 2 stroke outboard oil is strongly recommended for your Yamaha outboard motor. If Yamalube 2 stroke outboard oil is not available, a 2 stroke NMMA-certified TC-W3 oil of equivalent quality must be

# General information

used.

Recommended engine oil:  
YAMALUBE 2 STROKE OUTBOARD  
OIL

ECM01160

## CAUTION:

**Serious damage could result from use of a lesser quality oil.**

EMU25700

## Battery requirement

ECM01060

## CAUTION:

**Do not use a battery that does not meet the specified capacity. If a battery which does not meet specifications is used, the electric system could perform poorly or be overloaded, causing electric system damage.**

For electric start models, choose a battery which meets the following specifications.

EMU25720

## Battery specifications

Minimum cold cranking amps (CCA/EN):  
711.0 A  
Minimum rated capacity (20HR/IEC):  
100.0 Ah

## NOTE:

The engine cannot be started if battery voltage is too low.

EMU25742

## Propeller selection

The performance of your outboard motor will be critically affected by your choice of propeller, as an incorrect choice could adversely affect performance and could also seriously damage the motor. Engine speed depends on the propeller size and boat load. If engine

speed is too high or too low for good engine performance, this will have an adverse effect on the engine.

Yamaha outboard motors are fitted with propellers chosen to perform well over a range of applications, but there may be uses where a propeller with a different pitch would be more appropriate. For a greater operating load, a smaller-pitch propeller is more suitable as it enables the correct engine speed to be maintained. Conversely, a larger-pitch propeller is more suitable for a smaller operating load.

Yamaha dealers stock a range of propellers, and can advise you and install a propeller on your outboard that is best suited to your application.

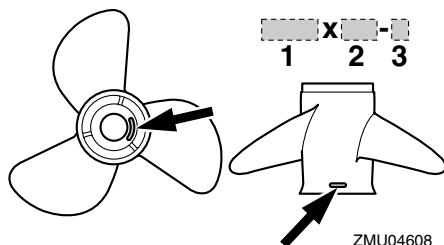

1. Propeller diameter in inches
2. Propeller pitch in inches
3. Type of propeller (propeller mark)

## NOTE:

Select a propeller which will allow the engine to reach the middle or upper half of the operating range at full throttle with the maximum boat load. If operating conditions such as light boat loads then allow the engine r/min to rise above the maximum recommended range, reduce the throttle setting to maintain the engine in the proper operating range.

For instructions on propeller removal and installation, see page 53.

EMU25760

## Start-in-gear protection

Yamaha outboard motors affixed with the pictured label or Yamaha-approved remote control units are equipped with start-in-gear protection device(s). This feature permits the engine to be started only when it is in neutral. Always select neutral before starting the engine.

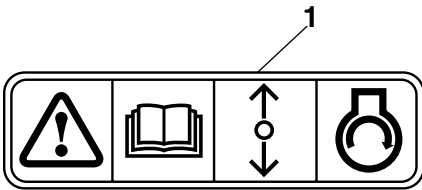

ZMU01713

1. Start-in-gear protection label

# Basic components

EMU25799

## Main components

### NOTE:

\* May not be exactly as shown; also may not be included as standard equipment on all models.

### Z250F

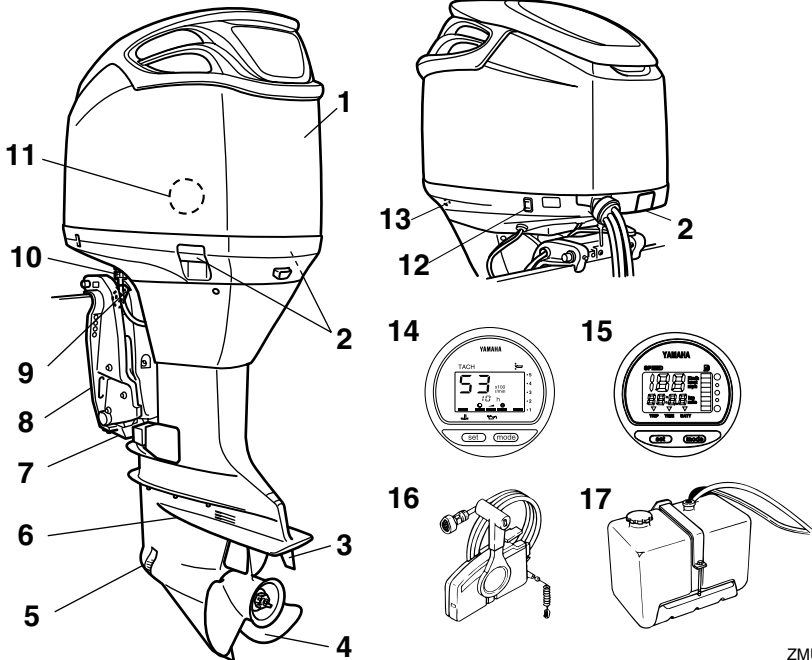

ZMU02097

1. Top cowling
2. Top cowling lock lever(s)
3. Trim tab
4. Propeller\*
5. Cooling water inlet
6. Anti-cavitation plate
7. Anode
8. Clamp bracket
9. Tilt support lever
10. Flushing device
11. Water separator
12. Power trim and tilt switch
13. Cooling water pilot hole
14. Digital tachometer\*

15. Digital speedometer\*
16. Remote control box (side mount type)\*
17. Remote oil tank\*

# Basic components

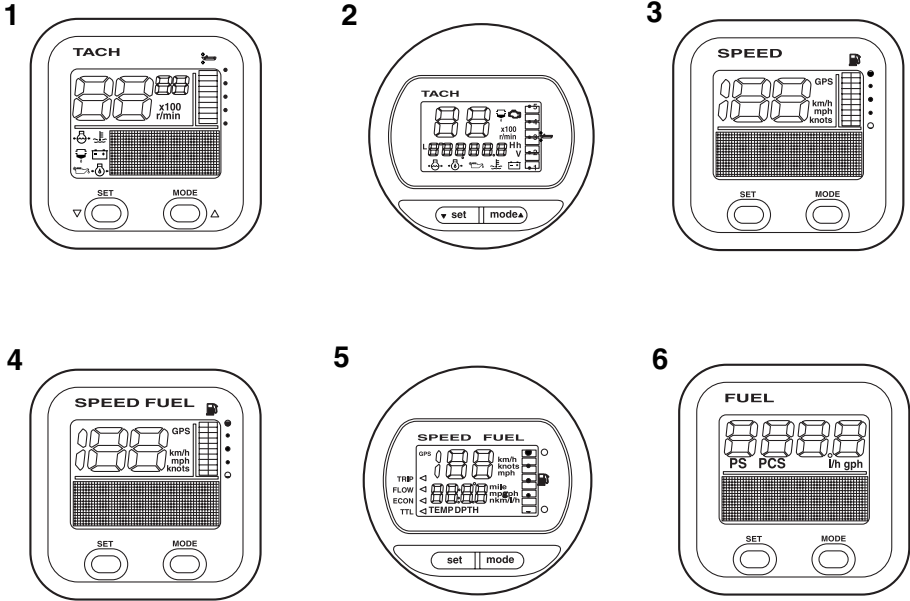

ZMU05429

1. Tachometer unit (Square type)\*
2. Tachometer unit (Round type)\*
3. Speedometer unit (Square type)\*
4. Speed & fuel meter unit (Square type)\*
5. Speed & fuel meter unit (Round type)\*
6. Fuel management meter (Square type)\*

EMU26180

## Remote control

The remote control lever actuates both the shifter and the throttle. The electrical switches are mounted on the remote control box.

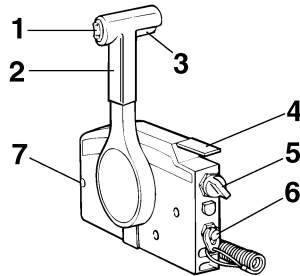

ZMU01723

1. Power trim and tilt switch
2. Remote control lever
3. Neutral interlock trigger
4. Neutral throttle lever
5. Main switch / choke switch
6. Engine stop lanyard switch
7. Throttle friction adjuster

# Basic components

EMU26190

## Remote control lever

Moving the lever forward from the neutral position engages forward gear. Pulling the lever back from neutral engages reverse. The engine will continue to run at idle until the lever is moved about 35° (a detent can be felt). Moving the lever farther opens the throttle, and the engine will begin to accelerate.

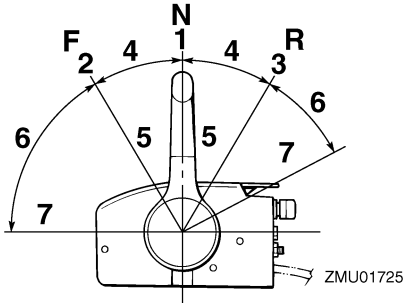

1. Neutral "N"
2. Forward "F"
3. Reverse "R"
4. Shift
5. Fully closed
6. Throttle
7. Fully open

EMU26201

## Neutral interlock trigger

To shift out of neutral, first pull the neutral interlock trigger up.

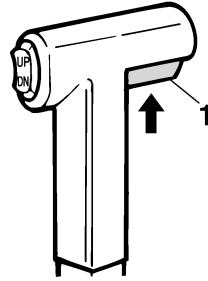

ZMU01727

1. Neutral interlock trigger

EMU26211

## Neutral throttle lever

To open the throttle without shifting into either forward or reverse, put the remote control lever in the neutral position and lift the neutral throttle lever.

### NOTE:

The neutral throttle lever will operate only when the remote control lever is in neutral. The remote control lever will operate only when the neutral throttle lever is in the closed position.

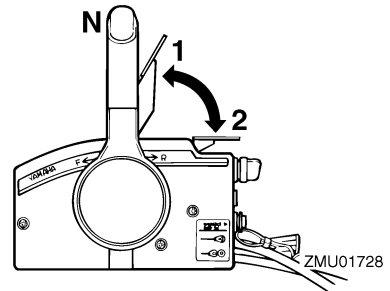

1. Fully open
2. Fully closed

EMU25971

## Throttle friction adjuster

A friction device provides adjustable resistance to movement of the throttle grip or the

# Basic components

remote control lever, and can be set according to operator preference.

To increase resistance, turn the adjuster clockwise. To decrease resistance, turn the adjuster counterclockwise.

EWM00031

## WARNING

Do not overtighten the friction adjuster. If there is too much resistance, it could be difficult to move the remote control lever or throttle grip, which could result in an accident.

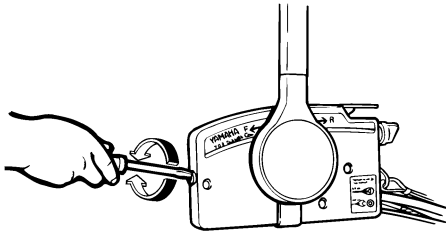

ZMU01714

When constant speed is desired, tighten the adjuster to maintain the desired throttle setting.

EMU25990

## Engine stop lanyard switch

The lock plate must be attached to the engine stop switch for the engine to run. The lanyard should be attached to a secure place on the operator's clothing, or arm or leg. Should the operator fall overboard or leave the helm, the lanyard will pull out the lock plate, stopping ignition to the engine. This will prevent the boat from running away under power.

EWM00120

## WARNING

● Attach the engine stop switch lanyard to a secure place on your clothing, or

your arm or leg while operating.

- Do not attach the lanyard to clothing that could tear loose. Do not route the lanyard where it could become entangled, preventing it from functioning.
- Avoid accidentally pulling the lanyard during normal operation. Loss of engine power means the loss of most steering control. Also, without engine power, the boat could slow rapidly. This could cause people and objects in the boat to be thrown forward.

## NOTE:

The engine cannot be started with the lock plate removed.

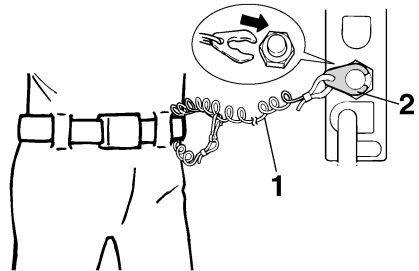

ZMU01716

1. Lanyard
2. Lock plate

EMU26090

## Main switch

The main switch controls the ignition system; its operation is described below.

### ● "OFF" (off)

With the main switch in the "OFF" (off) position, the electrical circuits are off, and the key can be removed.

### ● "ON" (on)

With the main switch in the "ON" (on) position, the electrical circuits are on, and the key cannot be removed.

# Basic components

## ● “START” (start)

With the main switch in the “START” (start) position, the starter motor turns to start the engine. When the key is released, it returns automatically to the “ON” (on) position.

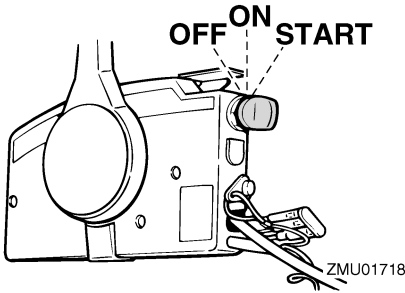

EMU26141

## Power trim and tilt switch on remote control or tiller handle

The power trim and tilt system adjusts the outboard motor angle in relation to the transom. Pressing the switch “UP” (up) trims the outboard motor up, then tilts it up. Pressing the switch “DN” (down) tilts the outboard motor down and trims it down. When the switch is released, the outboard motor will stop in its current position.

### NOTE:

For instructions on using the power trim and tilt switch, see pages 35 and 37.

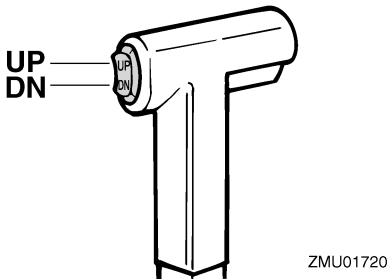

EMU26151

## Power trim and tilt switch on bottom engine cowling

The power trim and tilt switch is located on the side of the bottom engine cowling. Pressing the switch “UP” (up) trims the outboard motor up, then tilts it up. Pressing the switch “DN” (down) tilts the outboard motor down and trims it down. When the switch is released, the outboard motor will stop in its current position.

EWM01030

### ⚠ WARNING

Use the power trim and tilt switch located on the bottom engine cowling only when the boat is at a complete stop with the engine off. Attempting to use this switch while the boat is moving could increase the risk of falling overboard and could distract the operator, increasing the risk of collision with another boat or an obstacle.

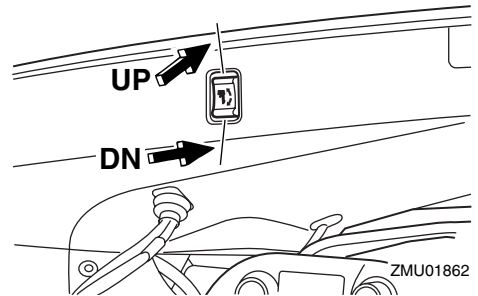

### NOTE:

For instructions on using the power trim and tilt switch, see page 37.

EMU26241

## Trim tab with anode

The trim tab should be adjusted so that the steering control can be turned to either the right or left by applying the same amount of



# Basic components

force.

EWM00840

## WARNING

An improperly adjusted trim tab could cause difficult steering. Always test run after the trim tab has been installed or replaced to be sure steering is correct. Be sure you have tightened the bolt after adjusting the trim tab.

If the boat tends to veer the left (port side), turn the trim tab rear end to the port side "A" in the figure. If the boat tends to veer the right (starboard side), turn the trim tab end to the starboard side "B" in the figure.

ECM00840

## CAUTION:

The trim tab also serves as an anode to protect the engine from electrochemical corrosion. Never paint the trim tab as it will become ineffective as an anode.

2. Bolt

3. Cap

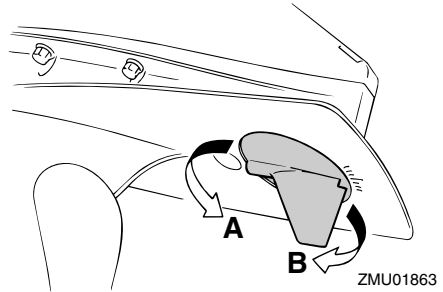

ZMU01863

EMU26340

## Tilt support lever for power trim and tilt or hydro tilt model

To keep the outboard motor in the tilted up position, lock the tilt support lever to the clamp bracket.

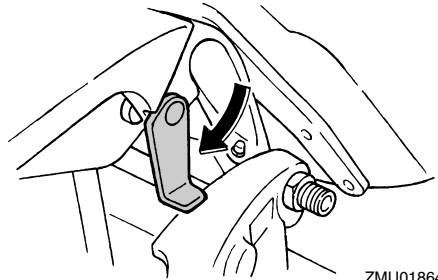

ZMU01864

EMU26391

## Top cowling lock levers

To remove the outboard motor top cowling, pull up the front and rear lock levers. Then lift off the cowling. When the cowling, check to be sure it fits properly in the rubber seal. Then lock the cowling again by moving the levers downward.

ECM00550

## CAUTION:

The air intake grille on the top cowling is not designed as a handle and could break

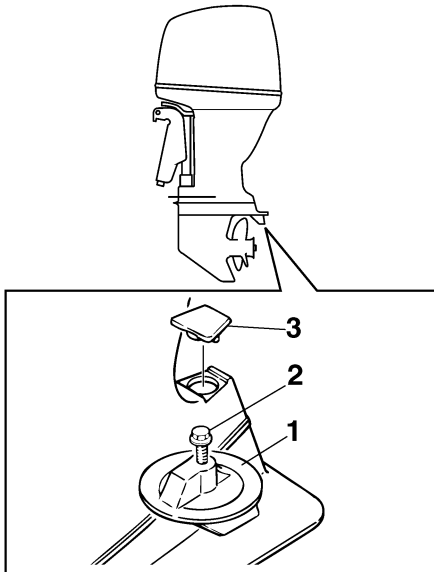

ZMU01730

1. Trim tab

# Basic components

if used as such.

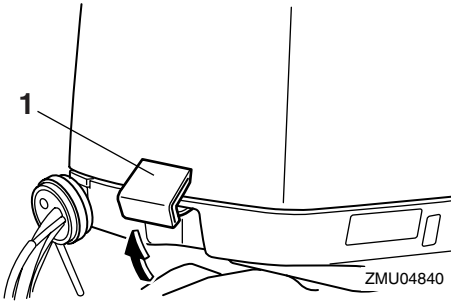

1. Top cowling lock lever(s)

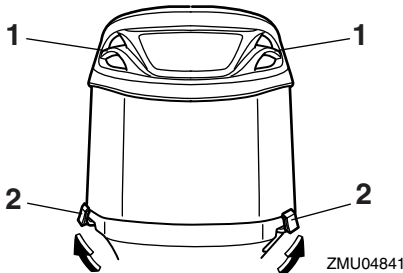

1. Air intake grille  
2. Top cowling lock lever(s)

EMU26460

## Flushing device

This device is used to clean the cooling water passages of the motor using a garden hose and tap water.

### NOTE:

For details on usage, see page 44.

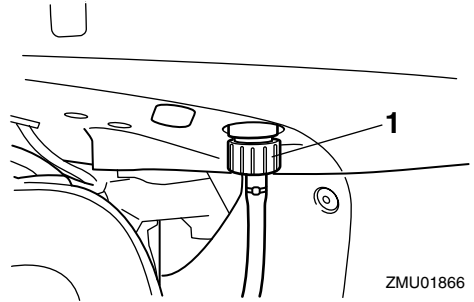

1. Flushing device

EMU31702

## Water separator

This engine has a combination fuel filter/water separator and associated warning system. If water separated from the fuel exceeds a specific volume, the warning device will activate.

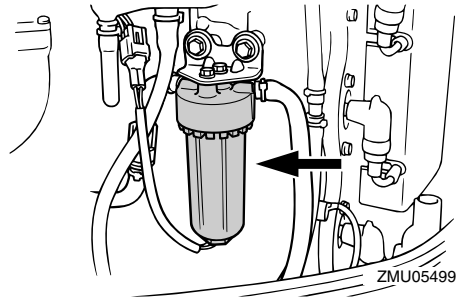

Activation of warning device

- The water separator warning indicator will blink.
- The buzzer will sound intermittently only when the gear shift is in neutral.
- If the warning system has activated, stop the engine and consult a Yamaha dealer immediately.

EMU26491

## Digital tachometer

The tachometer shows the engine speed and has the following functions.

# Basic components

## NOTE:

All segments of the display will light momentarily after the main switch is turned on and will return to normal thereafter.

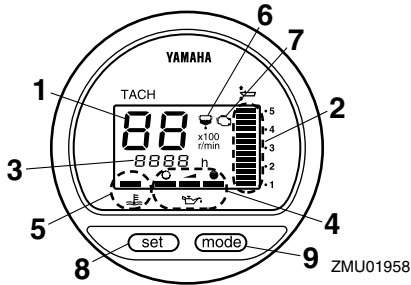

1. Tachometer
2. Trim meter
3. Hour meter
4. Oil level indicator
5. Overheat warning indicator
6. Water separator warning indicator
7. Engine trouble warning indicator
8. Set button
9. Mode button

## NOTE:

The water separator and engine trouble warning indicators only operate when the engine is equipped with the appropriate functions.

EMU26550

### Oil level indicator (digital type)

This indicator shows the engine oil level. If the oil level falls below the lower limit, the warning indicator will start to blink. For further information, see page 24.

ECM00030

### CAUTION:

**Do not operate the engine without oil. Serious engine damage will occur.**

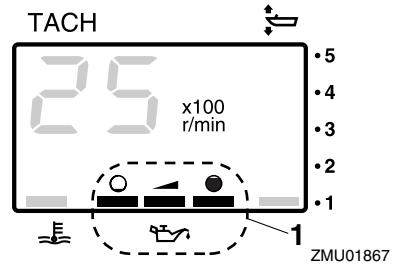

1. Oil level indicator

EMU26581

### Overheat warning indicator (digital type)

If the engine temperature rises too high, the warning indicator will start to blink. For further information on reading the indicator, see page 23.

ECM00050

### CAUTION:

**Do not continue to run the engine if the overheat warning indicator is on. Serious engine damage will occur.**

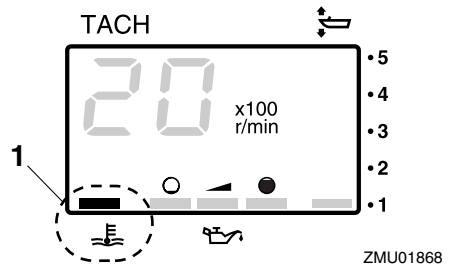

1. Overheat warning indicator

EMU26600

### Speedometer (digital type)

This gauge shows the boat speed.

# Basic components

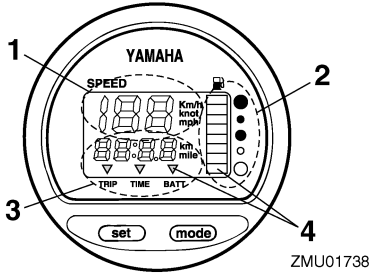

1. Speedometer
2. Fuel gauge
3. Trip meter/clock/voltmeter
4. Warning indicator(s)

**NOTE:**

After the main switch is first turned on, all segments of the display come on as a test. After a few seconds, the gauge will change to normal operation. Watch the gauge when turning on the main switch to make sure all segments come on.

**NOTE:**

The speedometer displays km/h, mph, or knots, according to operator preference. Select the desired unit of measurement by setting the selector switch on the back of the gauge. See the illustration for settings.

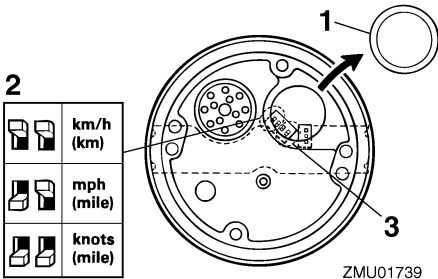

1. Cap
2. Selector switch (for speed unit)

3. Selector switch (for fuel sensor)

EMU26620

**Trim meter (digital type)**

This meter shows the trim angle of your out-board motor.

**NOTE:**

- Memorize the trim angles that work best for your boat under different conditions. Adjust the trim angle to the desired using the power trim and tilt switch.
- If the trim angle of your motor exceeds the trim operating range, the top segment on the trim meter display will blink.

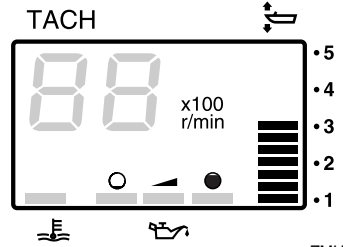

ZMU01869

EMU26650

**Hour meter (digital type)**

This meter shows the number of hours the engine has been run. It can be set to show the total number of hours or the number of hours for the current trip. The display can also be turned on and off.

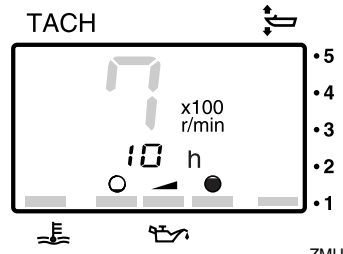

ZMU01870

# Basic components

- Changing the display format
- Pressing the “mode” (mode) button changes the display format in the following pattern:
  - Total hours→Trip hours→Display off
  - Resetting the trip hours
  - Simultaneously pressing the “set” (set) and “mode” (mode) buttons for more than 1 second while the trip hours are displayed resets the trip counter to 0 (zero).

## NOTE:

The total number of hours the engine has been run cannot be reset.

EMU26690

## Trip meter

This gauge displays the distance the boat has traveled since the gauge was last reset. Press the “mode” (mode) button repeatedly until the indicator on the face of the gauge points to “TRIP” (trip). To reset the trip meter to zero, press the “set” (set) and “mode” (mode) buttons at the same time.

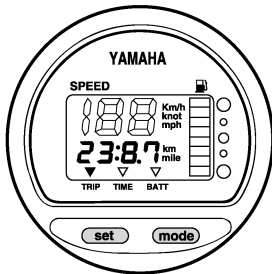

ZMU01743

## NOTE:

- The trip distance is shown in kilometers or miles depending upon the unit of measurement selected for the speedometer.
- The trip distance is kept in memory by battery power. The stored data will be lost if the battery is disconnected.

EMU26700

## Clock

Press the “mode” (mode) button repeatedly until the indicator on the face of the gauge points to “TIME” (time). To set the clock, be sure the gauge is in the “TIME” (time) mode. Press the “set” (set) button; the hour display will begin blinking. Press the “mode” (mode) button until the desired hour is displayed. Press the “set” (set) button again, the minute display will begin blinking. Press the “mode” (mode) button until the desired minute is displayed. Press the “set” (set) button again to start the clock.

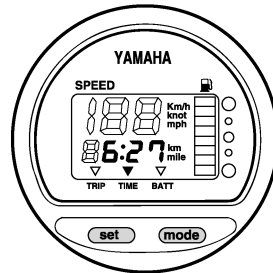

ZMU01744

## NOTE:

The clock operates on battery power. Disconnecting the battery will stop the clock. Reset the clock after connecting the battery.

EMU26710

## Fuel gauge

The fuel level is indicated by eight segments. When all segments are showing, the fuel tank is full.

ECM00860

## CAUTION:

The Yamaha fuel tank sensor differs from conventional sensors. Incorrectly setting the selector switch on the gauge will give false readings. Consult your Yamaha dealer on how to correctly set the selec-

# Basic components

tor switch.

**NOTE:**

The fuel level reading can be affected by the position of the sensor in the fuel tank and the attitude of the boat in the water. Operation with bow-up trim or continuous turning can give false readings.

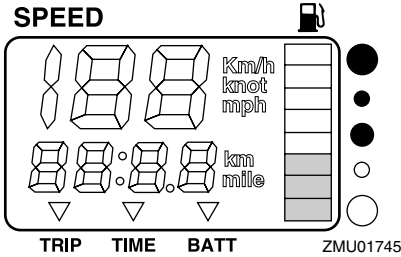

EMU26720

## Fuel warning indicator

If the fuel level decreases to one segment, the fuel level warning segment will begin to blink.

ECM00880

**CAUTION:**

**Do not continue to operate the engine with full throttle if a warning device has activated. Get back to the port within trolling engine speed.**

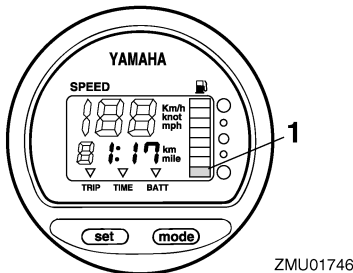

1. Fuel level warning segment

EMU26730

## Low battery voltage warning indicator

If battery voltage drops, the display will automatically turn on and begin to blink.

ECM00870

**CAUTION:**

**Get back to the port soon if a warning device has activated. For charging the battery, consult your Yamaha dealer.**

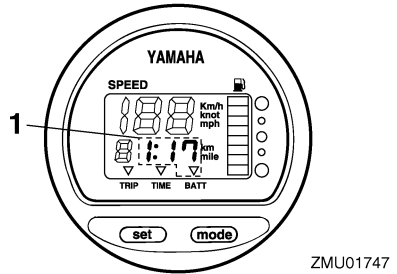

1. Low battery indicator

EMU31651

## 6Y8 Multifunction meters

Multifunction meters have 6 kinds of meter units; tachometer unit (square or round types), speedometer unit (square type), speed & fuel meter unit (square or round types), and fuel management meter (square type). The indicator system is slightly different between the round and square types. Check the model and type of your unit carefully. This manual describes mainly the warning indicators. For more details on setting meters or changing indicator systems, see the attached operation manual.

EMU31660

## Tachometer unit

The tachometer shows the engine revolutions per minute. It has functions of trim meter, adjusting trolling speed, cooling wa-

# Basic components

ter/engine temperature display, battery voltage display, total hour/trip hour display, oil level display, water detection warning, engine trouble warning, and periodic maintenance notification. If optional sensors are connected to the unit, cooling water pressure display will be available. For the optional sensor, consult your Yamaha dealer. The tachometer unit is available in round or square types. Check your tachometer unit type.

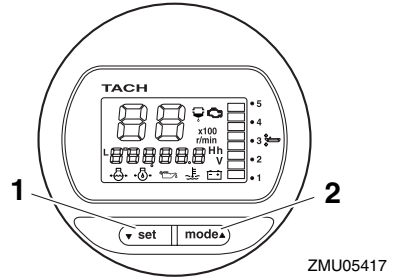

ZMU05417

1. Set button
2. Mode button

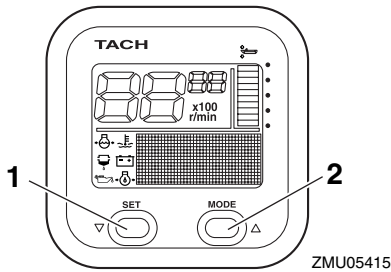

ZMU05415

1. Set button
2. Mode button

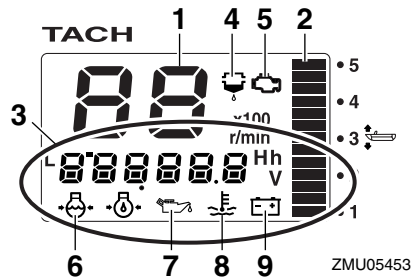

ZMU05453

1. Tachometer
2. Trim meter
3. Multifunction display
4. Water detection warning indicator
5. Engine trouble warning/maintenance indicator
6. Cooling water pressure
7. Oil level (2-stroke models)
8. Cooling water/engine temperature
9. Battery voltage

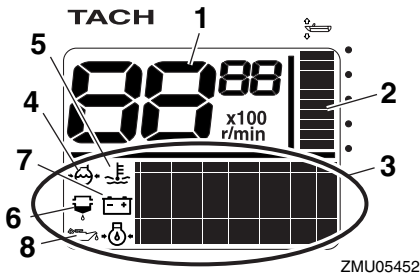

ZMU05452

1. Tachometer
2. Trim meter
3. Multifunction display
4. Cooling water pressure
5. Cooling water/engine temperature
6. Water detection warning indicator
7. Battery voltage
8. Oil level (2-stroke models)

## NOTE:

The tachometer unit shows various kinds of information according to the setting made using the "set" (set) and "mode" (mode) buttons. For details, see the attached operation manual.

# Basic components

## Preoperation checks

Place the gear shift lever in neutral and turn the main switch to "ON" (on). After all the displays come on and the total hour display comes on, the gauge will change to normal operation. If the buzzer sounds and the water separator warning indicator blinks, consult your Yamaha dealer immediately.

### NOTE:

To stop the buzzer, press the "set" (set) or "mode" (mode) button.

## Oil level warning

When the oil level is low while cruising, the oil level warning indicator will start to blink. The engine speed will automatically decrease to about 2000 r/min.

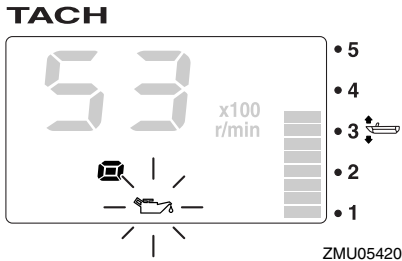
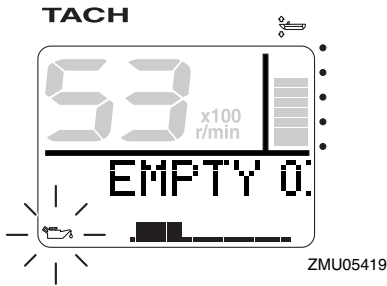

When the buzzer sounds and the oil level warning indicator blinks, check the oil level and add the oil if necessary. If the warning device has activated while the appropriate

engine oil level is maintained, consult your Yamaha dealer.

ECM01580

### CAUTION:

**Do not continue to run the engine if the oil level warning device has activated. Serious engine damage will occur.**

## Overheat warning

If the engine temperature rises too high while cruising, the overheat warning indicator will start to blink. The engine speed will automatically decrease to about 2000 r/min.

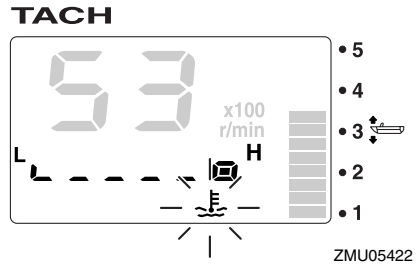
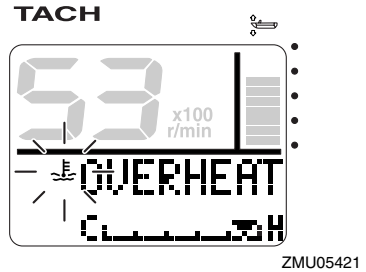

Stop the engine immediately if the buzzer sounds and the overheat warning device has activated. Check the cooling water inlet for clogging.

ECM01590

### CAUTION:

**Do not continue to run the engine if the overheat warning indicator blinks. Serious engine damage will occur.**



# Basic components

ous engine damage will occur.

- Do not continue to operate the engine if a warning device has activated. Consult your Yamaha dealer if the problem cannot be located and corrected.

## Water separator warning

This indicator will blink when water has accumulated in the water separator (fuel filter) while cruising. In such an event, stop the engine immediately and see page 63 of this manual to drain the water from the fuel filter. Get back to the port soon and consult a Yamaha dealer immediately.

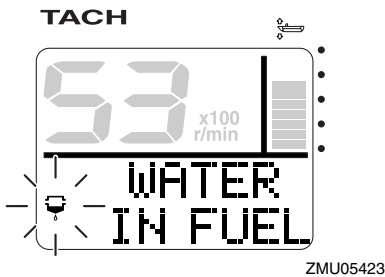

ZMU05423

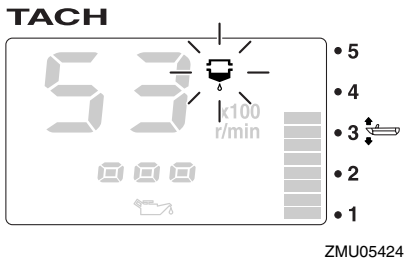

ZMU05424

ECM00910

## CAUTION:

**Gasoline mixed with water could cause damage to the engine.**

## Engine trouble warning

This indicator will blink when the engine malfunctions while cruising. Get back to the port

soon and consult a Yamaha dealer immediately.

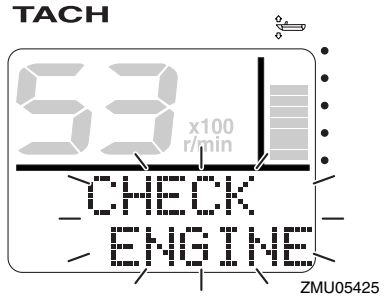

ZMU05425

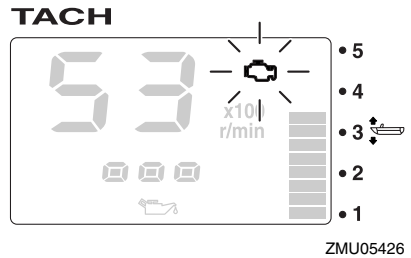

ZMU05426

ECM00920

## CAUTION:

**In such an event, the engine will not operate properly. Consult a Yamaha dealer immediately.**

## Low battery voltage warning

When the battery voltage drops, the low battery voltage warning indicator and the battery voltage value will start to blink. Get back to the port soon if the low battery voltage warning device has activated. For charging the battery, consult your Yamaha dealer.

# Basic components

## TACH

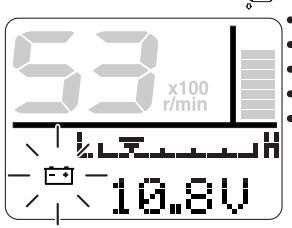

ZMU05427

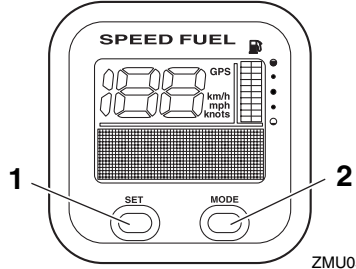

ZMU05432

1. Set button
2. Mode button

## TACH

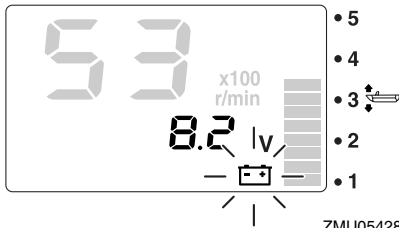

ZMU05428

EMU31610

## Speed & fuel meter unit

This unit shows the boat speed and has the functions of fuel meter, total fuel consumption display, fuel economy display, fuel flow display, and system voltage display. If optional sensors are connected to the unit, trip display, water surface temperature display, depth display, and clock will be available. For the optional sensor, consult your Yamaha dealer. The speed & fuel meter unit is available in round or square types. Check your speed & fuel meter unit type.

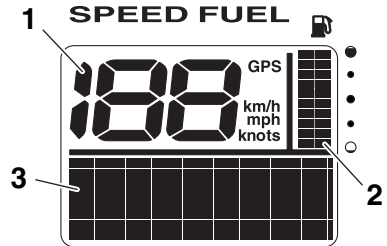

ZMU05433

1. Speedometer
2. Fuel meter
3. Multifunction display

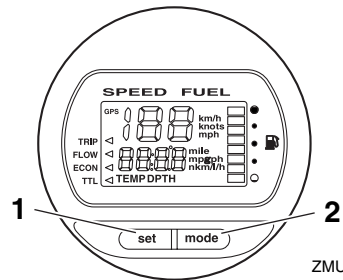

ZMU05434

1. Set button
2. Mode button

# Basic components

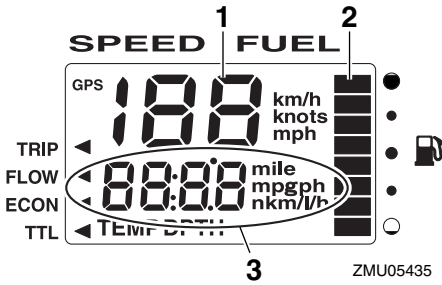

1. Speedometer
2. Fuel meter
3. Multifunction display

## NOTE: \_\_\_\_\_

After the main switch is first turned on, all the displays come on as a test. After a few seconds, the gauge will change to normal operation.

## NOTE: \_\_\_\_\_

The speed & fuel meter unit shows various kinds of information according to the setting made with the “set” (set) and “mode” (mode) buttons. For details, see the attached operation manual.

EMU31620

## Speedometer unit

This unit shows the boat speed and has functions of fuel meter and system voltage display. If optional sensors are connected to the unit, trip display, water surface temperature display, depth display, and clock will be available. For the optional sensor, consult your Yamaha dealer.

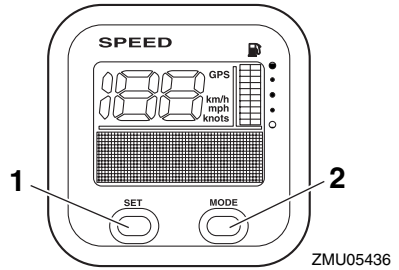

1. Set button
2. Mode button

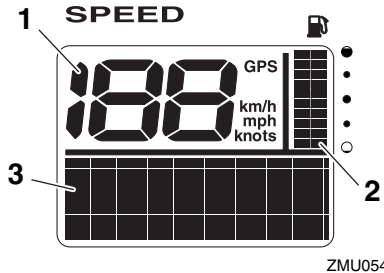

1. Speedometer
2. Fuel meter
3. Multifunction display

## NOTE: \_\_\_\_\_

After the main switch is first turned on, all the displays come on as a test. After a few seconds, the gauge will change to normal operation.

## NOTE: \_\_\_\_\_

The speedometer unit shows various kinds of information according to the setting made using the “set” (set) and “mode” (mode) buttons. In addition, the speedometer can show the desired unit of measurement such as km/h, mph, or knots. For details, see the attached operation manual.

# Basic components

EMU31630

## Fuel management meter

This meter has functions of fuel flow meter, total consumption display, fuel economy display, and remaining fuel display.

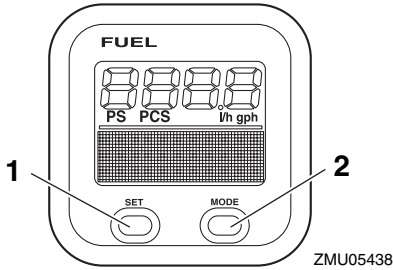

1. Set button
2. Mode button

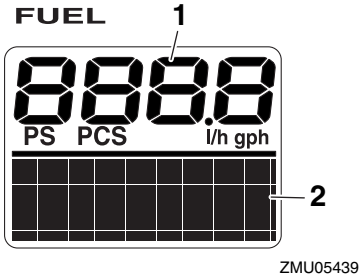

1. Fuel flow meter
2. Multifunction display

**NOTE:** \_\_\_\_\_

After the main switch is first turned on, all the displays come on as a test. After a few seconds, the gauge will change to normal operation.

**NOTE:** \_\_\_\_\_

The fuel management meter shows various kinds of information when the operator uses the "set" (set) and "mode" (mode) buttons. For details, see the attached operation man-

ual.

EMU26801

## Warning system

ECM00090

**CAUTION:** \_\_\_\_\_

**Do not continue to operate the engine if a warning device has activated. Consult your Yamaha dealer if the problem cannot be located and corrected.**

EMU26816

## Overheat warning

This engine has an overheat warning device. If the engine temperature rises too high, the warning device will activate.

### Activation of warning device

- The engine speed will automatically decrease to about 2000 r/min.
- If equipped with an overheat warning indicator, it will light or blink.

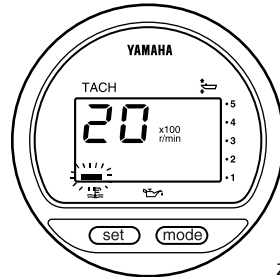

- The buzzer will sound (if equipped on the tiller handle, remote control box, or main switch panel).

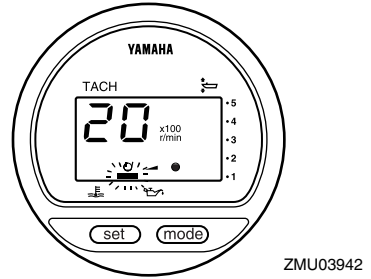
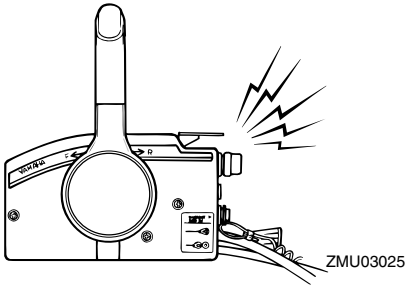

If the warning system has activated, stop the engine and check the cooling water inlet for clogging.

- The buzzer will sound (if equipped on the tiller handle, remote control box, or main switch panel).

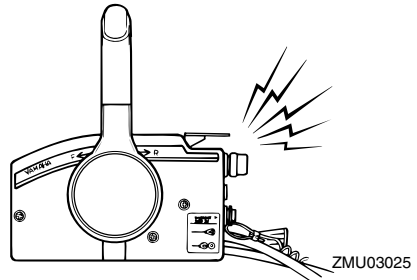
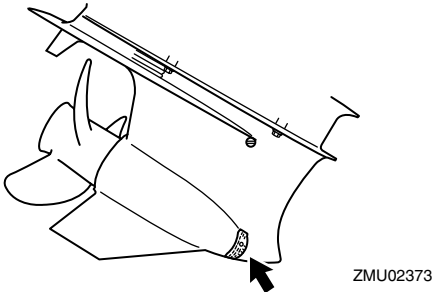

EMU26846

## Oil level warning and oil filter clogging warning

### Oil injection models

This engine has an oil level warning system. If the oil level falls below the lower limit, the warning system will activate.

### Activation of warning device

- Engine speed will automatically decrease to about 2000 r/min.
- The oil level warning indicator will light or blink.

If the warning system has been activated, stop the engine and check for the cause.

### NOTE:

The warning for oil filter clogging is similar to the warnings for low oil level and overheating. To make troubleshooting easier, check for engine overheating first, then oil level, and finally oil filter clogging.

# Basic components

---

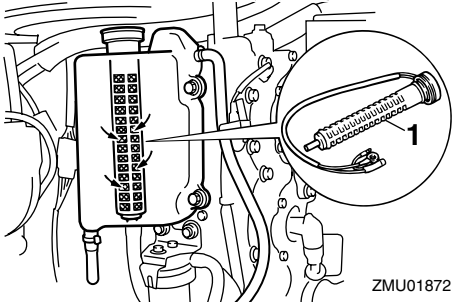

ZMU01872

1. Oil filter

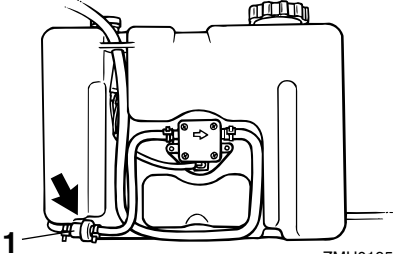

ZMU01952

1. Oil filter

EMU26901

## Installation

ECM00110

### CAUTION:

Incorrect engine height or obstructions to smooth water flow (such as the design or condition of the boat, or accessories such as transom ladders or depth finder transducers) can create airborne water spray while the boat is cruising. Severe engine damage may result if the motor is operated continuously in the presence of airborne water spray.

### NOTE:

During water testing check the buoyancy of the boat, at rest, with its maximum load. Check that the static water level on the exhaust housing is low enough to prevent water entry into the powerhead, when water rises due to waves when the outboard is not running.

EMU26910

## Mounting the outboard motor

EWM00820

### WARNING

- Overpowering a boat could cause severe instability. Do not install an outboard motor with more horsepower than the maximum rating on the capacity plate of the boat. If the boat does not have a capacity plate, consult the boat manufacturer.
- The information presented in this section is intended as reference only. It is not possible to provide complete instructions for every possible boat and motor combination. Proper mounting depends in part on experience and the

specific boat and motor combination.

EWM00830

### WARNING

Improper mounting of the outboard motor could result in hazardous conditions such as poor handling, loss of control, or fire hazards. Observe the following:

- For permanently mounted models, your dealer or other person experienced in proper rigging should mount the motor. If you are mounting the motor yourself, you should be trained by an experienced person.
- For portable models, your dealer or other person experienced in proper outboard motor mounting should show you how to mount your motor.

Mount the outboard motor on the center line (keel line) of the boat, and ensure that the boat itself is well balanced. Otherwise the boat will be hard to steer. For boats without a keel or which are asymmetrical, consult your dealer.

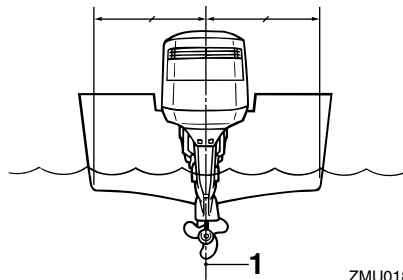

ZMU01873

1. Center line (keel line)

EMU26950

## Mounting height

To run your boat at optimum efficiency, the water resistance (drag) of the boat and outboard motor must be made as little as possible. The mounting height of the outboard

# Operation

motor greatly affects the water resistance. If the mounting height is too high, cavitation tends to occur, thus reducing the propulsion and causing the engine to overheat. If the mounting height is too low, the water resistance will increase and thereby reduce engine efficiency. Mount the outboard motor so that the anti-cavitation plate is about 130 mm (5 in.) above the bottom of the boat.

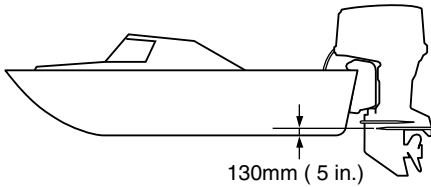

ZMU02098

## NOTE:

- The optimum mounting height of the outboard motor is affected by the boat and motor combination and the desired use. Test runs at different heights can help determine the optimum mounting height. Consult your Yamaha dealer or boat manufacturer for further information on determining the proper mounting height.
- For instructions on setting the trim angle of the outboard motor, see page 35.

EMU27041

## Breaking in engine

Your new engine requires a period of break-in to allow mating surfaces of moving parts to wear in evenly. Correct break-in will help ensure proper performance and longer engine life.

ECM00750

## CAUTION:

- **Failure to follow the break-in procedure**

**could result in reduced engine life or even severe engine damage.**

- **Do not use premixed fuel in this engine because it could cause carbon deposits on the fuel injector and engine trouble.**
- **Follow the instructions for break-in carefully.**

## NOTE:

Leave the label pictured below on the top cowling until the break-in procedure has been completed. It may be removed afterwards.



ZMU01945

EMU27091

## Procedure for HPDI models

Run the engine under load (in gear with a propeller installed) for 10 hours as follows.

1. First 10 minutes:  
Run the engine at the lowest possible speed. A fast idle in neutral is best.



2. Next 50 minutes:  
Do not exceed half throttle (approximately 3000 r/min). Vary engine speed occasionally. If you have an easy-planing boat, accelerate at full throttle onto plane, then immediately reduce the throttle to 3000 r/min or less.
3. Next two hours:  
Accelerate at full throttle onto plane, then reduce engine speed to three-quarter throttle (approximately 4000 r/min). Vary engine speed occasionally. Run at full throttle for one minute, then allow about 10 minutes of operation at three-quarter throttle or less to let the engine cool.
4. Remaining seven hours:  
Run the engine at any speed. However, avoid operating at full throttle for more than 5 minutes at a time.
5. After the first 10 hours:  
Operate the engine normally.

EMU27103

## Preoperation checks

EWM00080



### WARNING

**If any item in the preoperation check is not working properly, have it inspected and repaired before operating the outboard motor. Otherwise an accident could occur.**

ECM00120

### CAUTION:

**Do not start the engine out of water. Overheating and serious engine damage can occur.**

EMU31550

### Fuel

- Check to be sure you have plenty of fuel for your trip.
- Make sure there are no fuel leaks or gaso-

line fumes.

- Check fuel line connections to be sure they are tight (if equipped Yamaha fuel tank or boat tank).
- Be sure the fuel tank is positioned on a secure, flat surface, and that the fuel line is not twisted or flattened, or likely to contact sharp objects (if equipped Yamaha fuel tank or boat tank).
- Check the water in the fuel filter with the water separator warning device. Place the gear shift lever in neutral and turn the main switch to "ON"(on). If the buzzer sounds and the water separator warning indicator blinks, consult your Yamaha dealer immediately.

EMU27120

### Oil

- Check to be sure you have plenty of oil for your trip.

EMU27130

### Controls

- Check throttle, shift, and steering for proper operation before starting the engine.
- The controls should work smoothly, without binding or unusual free play.
- Look for loose or damaged connections.
- Check operation of the starter and stop switches when the outboard motor is in the water.

EMU27150

### Engine

- Check the engine and engine mounting.
- Look for loose or damaged fasteners.
- Check the propeller for damage.
- Check that the battery is in good condition and the battery connections are secure.

EMU27221

### Operation after a long period of storage

When operating the engine after a long period (12 months) of storage, proceed as fol-

# Operation

lows:

1. Start the engine. Leave it idling.

EWM00090

## **WARNING**

- Do not touch or remove electrical parts when starting or during operation.
- Keep hands, hair, and clothes away from the flywheel and other rotating parts while the engine is running.

2. Watch for oil flowing through the oil feed pipes. After any air in the oil lines has been expelled, the oil injection system should supply oil normally. If no oil is flowing after 10 minutes of idling, consult your Yamaha dealer.

ECM00560

## **CAUTION:**

- Be sure to take the above steps when operating the engine after a long period of storage. Otherwise engine seizure could occur.
- Use straight gasoline only. If premix fuel is used, the fuel injector could be damaged.

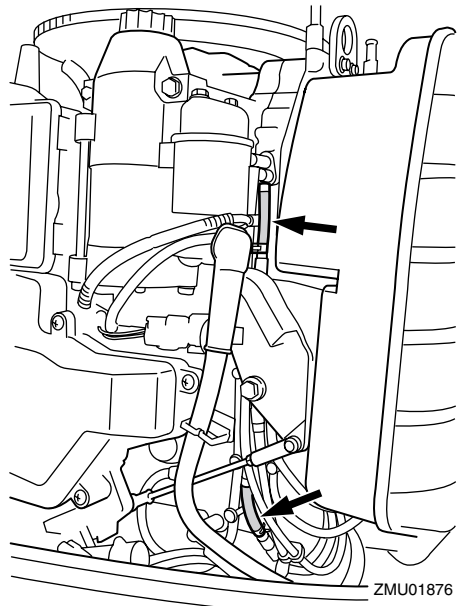
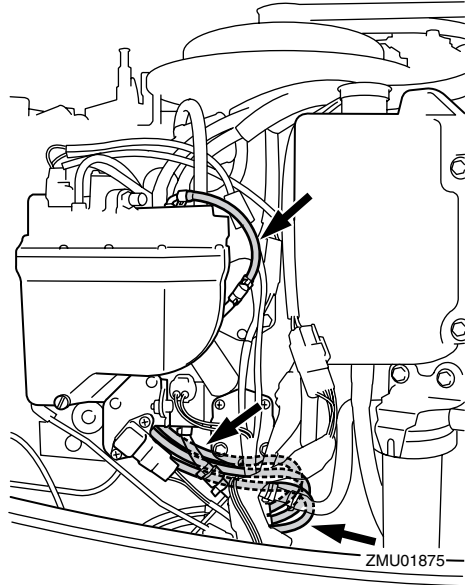

EMU27233

## Filling fuel and engine oil

EMU30320

### Filling fuel for models without a fuel joint

EWM00060

#### **WARNING**

Gasoline and its vapors are highly flammable and explosive. Keep away from sparks, cigarettes, flames, or other sources of ignition.

1. Remove the fuel tank cap.
2. Carefully fill the fuel tank.
3. Securely close the cap after filling the tank. Wipe up any spilled fuel.

EMU27292

### Filling oil for oil injection models

EWM00530

#### **WARNING**

Do not add gasoline into the oil tank. Fire or explosion could result.

This engine uses the Yamaha oil injection system, which provides superior lubrication by ensuring the proper oil ratio for all operating conditions. No fuel premixing is needed. Simply pour gasoline into the fuel tank and oil into the oil tank. Convenient indicators show the status of the oil supply. For details on how to read the indicators, see page 31. To fill the engine oil tank, proceed as follows:

1. Pour engine oil into the remote oil tank.

Remote oil tank capacity: 10.5 L (11.10 US qt) (9.24 Imp.qt)
---

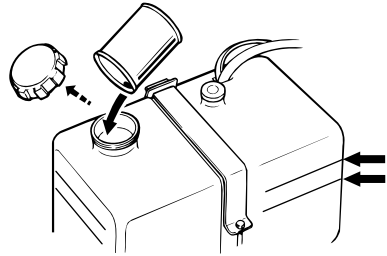

ZMU01877

#### **NOTE:**

The oil level lines on the remote oil tank indicate the amount of additional oil that can be added to the tank. The top oil level line indicates approximately 1.9 L (0.5 US gal, 0.4 Imp gal) can be added, and the bottom oil level line indicates approximately 3.8 L (1 US gal, 0.8 Imp gal) can be added.

2. Turn on the main switch. The Yamaha oil injection system will automatically feed oil from the remote oil tank to the engine oil tank.
3. Operate the engine normally.

ECM00570

#### **CAUTION:**

When the engine is operated for the first time or stored for a period of time, a minimum of 5 liters (5.3 US qt, 4.4 Imp qt) of oil should be kept in the remote oil tank. Otherwise the oil-feed pump chamber will not be filled with oil, and no oil will be supplied.

# Operation

EMU27321

## Oil level indicator operation

The various functions of the oil level system are as follows:

EMU27381

### Oil level indicator

#### Electric start models

Oil level warning indicator (digital tachometer)	Oil level warning indicator (analog tachometer)	Engine oil tank	Remote oil tank	Remarks
	Green 	more than 300 cm <sup>3</sup> (0.32 US qt, 0.26 Imp qt) 	more than 1500 cm <sup>3</sup> (1.6 US qt, 1.31 Imp qt) 	<ul style="list-style-type: none"> <li>No refilling necessary.</li> </ul>
	Yellow 	more than 300 cm <sup>3</sup> (0.32 US qt, 0.26 Imp qt) 	1500 cm <sup>3</sup> (1.6 US qt, 1.31 Imp qt) or less 	<ul style="list-style-type: none"> <li>Add oil; see page 30.</li> </ul>
	Red–Yellow–Green 	300 cm <sup>3</sup> (0.32 US qt, 0.26 Imp qt) or less 	more than 1500 cm <sup>3</sup> (1.6 US qt, 1.31 Imp qt) 	<ul style="list-style-type: none"> <li>Check oil filter for clogging.</li> <li>Check battery cable connection. Buzzer will sound.</li> <li>Engine speed is automatically reduced to about 2000 r/min.</li> </ul>
	Red 	300 cm <sup>3</sup> (0.32 US qt, 0.26 Imp qt) or less 	1500 cm <sup>3</sup> (1.6 US qt, 1.31 Imp qt) or less 	<ul style="list-style-type: none"> <li>Oil has not been added.</li> <li>Buzzer will sound.</li> <li>Engine speed is automatically reduced to about 2000 r/min.</li> <li>Buzzer sounds in remote control box and engine speed is limited to about 2000 r/min to help conserve oil.</li> </ul>

EMU27450

## Operating engine

EMU27482

### Feeding fuel

EWM00420

#### **WARNING**

- Before starting the engine, make sure that the boat is tightly moored and that you can steer clear of any obstructions. Be sure there are no swimmers in the water near you.
- When the air vent screw is loosened, gasoline vapor will be released. Gasoline is highly flammable, and its vapors are flammable and explosive. Refrain from smoking, and keep away from open flames and sparks while loosening the air vent screw.
- This product emits exhaust gases which contain carbon monoxide, a colorless, odorless gas which could cause brain damage or death when inhaled. Symptoms include nausea, dizziness, and drowsiness. Keep cockpit and cabin areas well ventilated. Avoid blocking exhaust outlets.

1. If there is an air vent screw on the fuel tank cap, loosen it 2 or 3 turns.
2. If there is a fuel joint or a fuel cock on the boat, firmly connect the fuel line to the joint or open the fuel cock.
3. Squeeze the primer pump, with the arrow pointing up, until you feel it become firm.

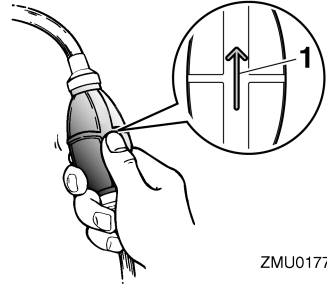

ZMU01770

1. Arrow

EMU27490

## Starting engine

EMU27662

### Electric start and remote control models

1. Place the remote control lever in neutral.

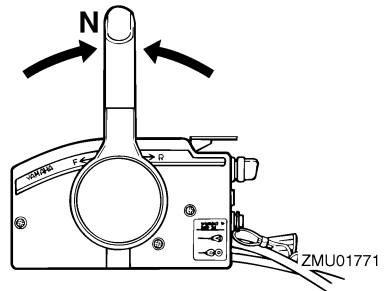

ZMU01771

#### **NOTE:**

The start-in-gear protection device prevents the engine from starting except when in neutral.

2. Attach the engine stop switch lanyard to a secure place on your clothing, or your arm or leg. Then install the lock plate on the other end of the lanyard into the engine stop switch.

EWM00120

#### **WARNING**

- Attach the engine stop switch lanyard to a secure place on your clothing, or

# Operation

your arm or leg while operating.

- Do not attach the lanyard to clothing that could tear loose. Do not route the lanyard where it could become entangled, preventing it from functioning.
- Avoid accidentally pulling the lanyard during normal operation. Loss of engine power means the loss of most steering control. Also, without engine power, the boat could slow rapidly. This could cause people and objects in the boat to be thrown forward.

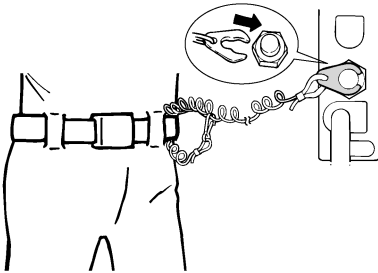

ZMU01772

3. Turn the main switch to “ON” (on).
4. Turn the main switch to “START” (start), and hold it for a maximum of 5 seconds.

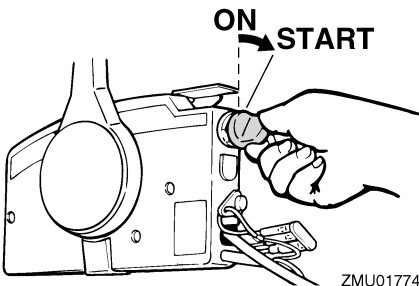

ZMU01774

5. Immediately after the engine starts, release the main switch and allow it to re-

turn to “ON” (on).

ECM00191

## CAUTION:

- Never turn the main switch to “START” (start) while the engine is running.
- Do not keep the starter motor turning for more than 5 seconds. If the starter motor is turned continuously for more than 5 seconds, the battery will be quickly discharged, thus making it impossible to start the engine. The starter can also be damaged. If the engine will not start after 5 seconds of cranking, return the main switch to “ON” (on), wait 10 seconds, then crank the engine again.

## NOTE:

- When the engine is cold, it needs to be warmed up. For further information, see page 33.
- If the engine is warm and fails to start, open the throttle slightly and try to start the engine again. If the engine still fails to start, see page 60.

EMU27670

## Warming up engine

EMU27702

### Electric start and prime start models

1. After starting the engine, allow it to idle for 3 minutes to warm up. Failure to do so will shorten engine life.
2. Check for a steady flow of water from the cooling water pilot hole.

ECM00511

## CAUTION:

**A continuous flow of water from the cooling water pilot hole shows that the water pump is pumping water through the cooling passages. If water is not flowing out of the hole at all times while the engine is**

running, overheating and serious damage could occur. Stop the engine and check whether the cooling water inlet on the lower case or the cooling water pilot hole is blocked. Consult your Yamaha dealer if the problem cannot be located and corrected.

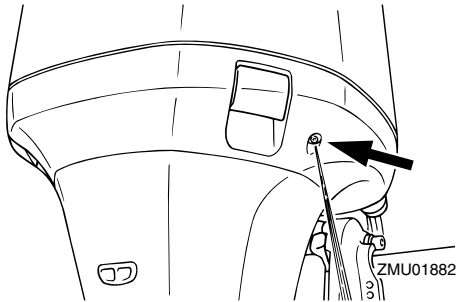

EMU27740

## Shifting

EWM00180



**Before shifting, make sure there are no swimmers or obstacles in the water near you.**

ECM00220

### **CAUTION:**

**To change the boat direction or shifting position from forward to reverse or vice-versa, first close the throttle so that the engine idles (or runs at low speeds).**

EMU27764

## Forward (tiller handle and remote control models)

### Tiller handle models

1. Place the throttle grip in the fully closed position.
2. Move the gear shift lever quickly and firmly from neutral to forward.

### Remote control models

1. Pull up the neutral interlock trigger (if

equipped) and move the remote control lever quickly and firmly from neutral to forward.

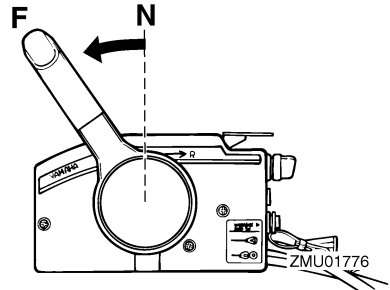

EMU27785

## Reverse (automatic reverse lock and power trim and tilt models)

EWM00190



**When operating in reverse, go slowly. Do not open the throttle more than half. Otherwise the boat could become unstable, which could result in loss of control and an accident.**

### Tiller handle models

1. Place the throttle grip in the fully closed position.
2. Move the gear shift lever quickly and firmly from neutral to reverse.

### Remote control models

1. Pull up the neutral interlock trigger (if equipped) and move the remote control lever quickly and firmly from neutral to reverse.

# Operation

EMU27861

## Trimming outboard motor

The trim angle of the outboard motor helps determine the position of the bow of the boat in the water. Correct trim angle will help improve performance and fuel economy while reducing strain on the engine. Correct trim angle depends upon the combination of boat, engine, and propeller. Correct trim is also affected by variables such as the load in the boat, sea conditions, and running speed.

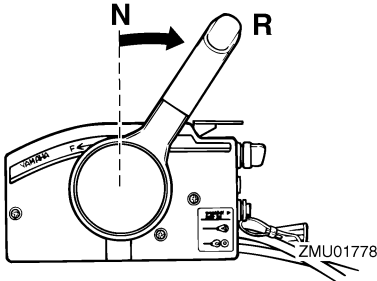

EMU27820

## Stopping engine

Before stopping the engine, first let it cool off for a few minutes at idle or low speed. Stopping the engine immediately after operating at high speed is not recommended.

EMU27852

### Procedure

1. Turn the main switch to "OFF" (off).

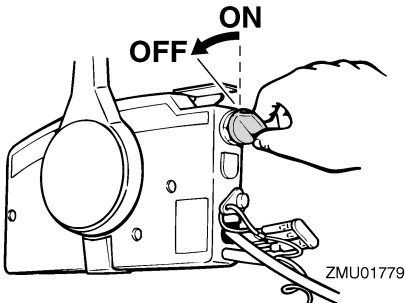

2. After stopping the engine, disconnect the fuel line or close the fuel cock if there is a fuel joint or a fuel cock on the boat.
3. Tighten the air vent screw on the fuel tank cap (if equipped).
4. Remove the key if the boat will be left unattended.

### NOTE:

The engine can also be stopped by pulling the lanyard and removing the clip from the engine stop switch, then turning the main switch to "OFF" (off).

EWM00740



**Excessive trim for the operating conditions (either trim up or trim down) can cause boat instability and can make steering the boat more difficult. This increases the possibility of an accident. If the boat begins to feel unstable or is hard to steer, slow down and/or readjust the trim angle.**



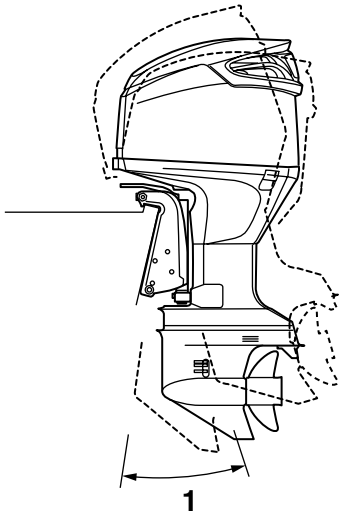

ZMU01983

1. Trim operating angle

EMU27882

## Adjusting trim angle

### Power trim and tilt models

EWM00751



## WARNING

- Be sure all people are clear of the outboard motor when adjusting the tilt angle, also be careful not to pinch any body parts between the drive unit and clamp bracket.
- Use caution when trying a trim position for the first time. Increase speed gradually and watch for any signs of instability or control problems. Improper trim angle can cause loss of control.
- If equipped with a power trim and tilt switch located on the bottom cowling, use the switch only when the boat is at a complete stop with the engine off. Do not adjust the trim angle with this

### switch while the boat is moving.

Adjust the outboard motor trim angle using the power trim and tilt switch.

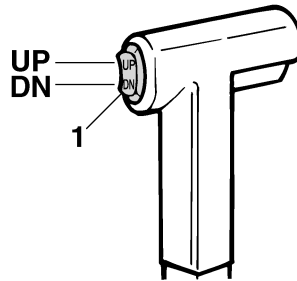

ZMU01781

1. Power trim and tilt switch

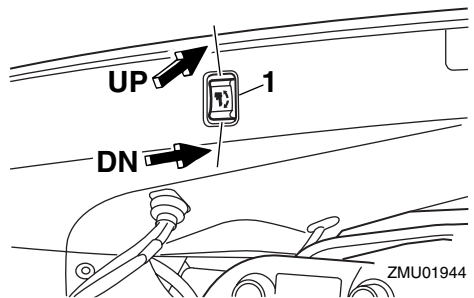

ZMU01944

1. Power trim and tilt switch

To raise the bow (trim-out), press the switch “UP” (up).

To lower the bow (trim-in), press the switch “DN” (down).

Make test runs with the trim set to different angles to find the position that works best for your boat and operating conditions.

EMU27911

## Adjusting boat trim

When the boat is on plane, a bow-up attitude results in less drag, greater stability and efficiency. This is generally when the keel line of the boat is up about 3 to 5 degrees. With the bow up, the boat may have a greater tenden-

# Operation

---

cy to steer to one side or the other. Compensate for this as you steer. The trim tab can also be adjusted to help offset this effect. When the bow of the boat is down, it is easier to accelerate from a standing start onto plane.

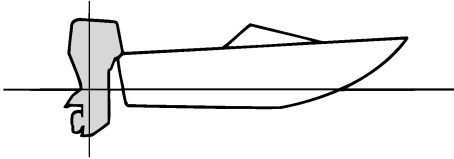

ZMU01784

## Bow Up

Too much trim-out puts the bow of the boat too high in the water. Performance and economy are decreased because the hull of the boat is pushing the water and there is more air drag. Excessive trim-out can also cause the propeller to ventilate, which reduces performance further, and the boat may “porpoise” (hop in the water), which could throw the operator and passengers overboard.

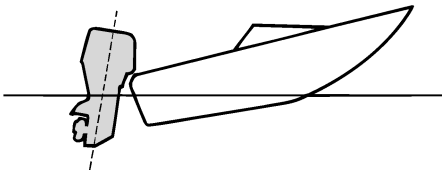

ZMU01785

## Bow Down

Too much trim-in causes the boat to “plow” through the water, decreasing fuel economy and making it hard to increase speed. Operating with excessive trim-in at higher speeds

also makes the boat unstable. Resistance at the bow is greatly increased, heightening the danger of “bow steering” and making operation difficult and dangerous.

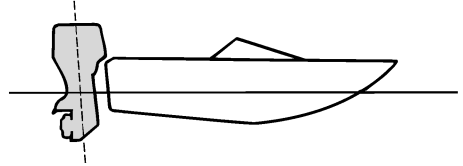

ZMU01786

## NOTE:

Depending on the type of boat, the outboard motor trim angle may have little effect on the trim of the boat when operating.

EMU27933

## Tilting up and down

If the engine will be stopped for some time or if the boat is moored in shallows, the outboard motor should be tilted up to protect the propeller and casing from damage by collision with obstructions, and also to reduce salt corrosion.

EWM00220

## WARNING

Be sure all people are clear of the outboard motor when tilting up and down, also be careful not to pinch any body parts between the drive unit and engine bracket.

EWM00250

## WARNING

Leaking fuel is a fire hazard. If there is a fuel joint on the outboard motor, disconnect the fuel line or close the fuel cock if the engine will be tilted for more than a

few minutes. Otherwise fuel may leak.

ECM00241

## CAUTION:

- Before tilting the outboard motor, stop the engine by following the procedure on page 35. Never tilt the outboard motor while the engine is running. Severe damage from overheating can result.
- Do not tilt up the engine by pushing the tiller handle (if equipped) because this could break the handle.

EMU28007

## Procedure for tilting up (power trim and tilt models / power tilt models)

1. Place the remote control lever / gear shift lever in neutral.

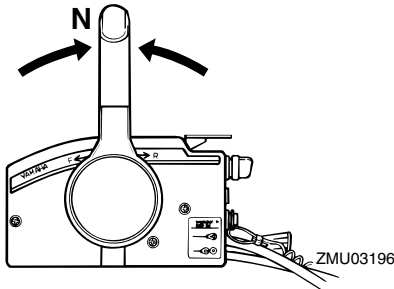

2. Disconnect the fuel line from the outboard motor or close the fuel cock.
3. Press the power trim and tilt switch / power tilt switch "UP" (up) until the outboard motor has tilted up completely.

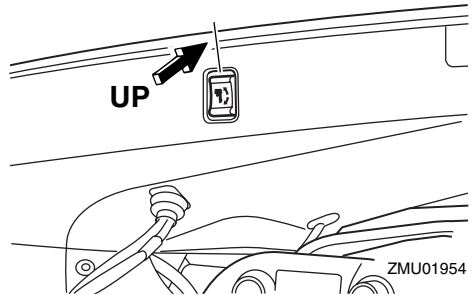
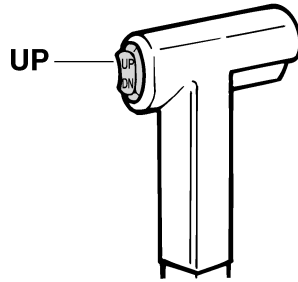

4. Push the tilt support knob into the clamp bracket or pull the tilt support lever toward you to support the engine.

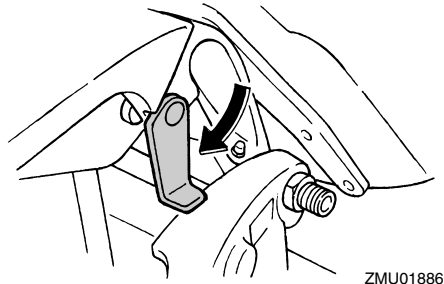

EWM00260

## WARNING

After tilting the outboard motor, be sure to support it with the tilt support knob or tilt support lever. Otherwise the outboard motor could fall back down suddenly if oil in the power trim and tilt unit loses pres-

# Operation

sure.

- Models equipped with trim rods: Once the outboard motor is supported with the tilt support lever, press the power trim and tilt switch / power tilt switch "DN" (down) to retract the trim rods.

ECM00250

## CAUTION:

**Be sure to retract the trim rods completely during mooring. This protects the rods from marine growth and corrosion which could damage the power trim and tilt mechanism.**

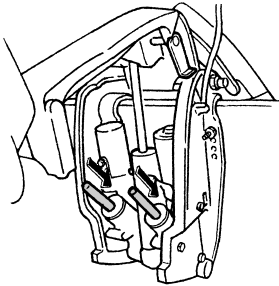

ZMU01884

EMU28055

## Procedure for tilting down (power trim and tilt models / power tilt models)

- Push the power trim and tilt switch / power tilt switch "UP" (up) until the outboard motor is supported by the tilt rod and the tilt support lever / tilt support knob becomes free.
- Release the tilt support lever or pull out the tilt support knob.

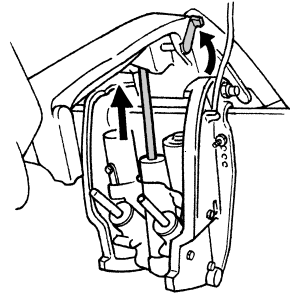

ZMU01885

- Push the power trim and tilt switch / power tilt switch "DN" (down) to lower the outboard motor to the desired position.

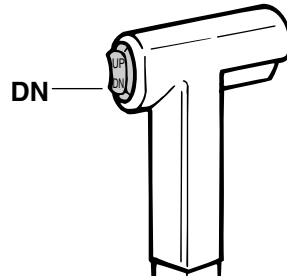

ZMU01936

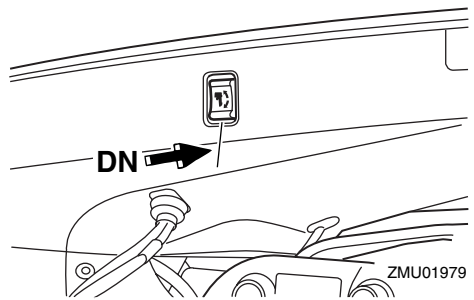

ZMU01979

EMU28060

## Cruising in shallow water

The outboard motor can be tilted up partially to allow operation in shallow water.

EMU28090

## Power trim and tilt models / power tilt models

The outboard motor can be tilted up partially

to allow operation in shallow water.

EWM00660

## **WARNING**

- Place the gear shift in neutral before setting up for shallow water cruising.
- Return the outboard motor to its normal position as soon as the boat is back in deeper water.

ECM00260

## **CAUTION:**

Do not tilt the outboard motor up so that the cooling water inlet on the lower unit is above the surface of the water when setting up for and cruising in shallow water. Otherwise severe damage from overheating can result.

EMU28185

## **Procedure for power trim and tilt / power tilt models**

1. Place the remote control lever / gear shift lever in neutral.

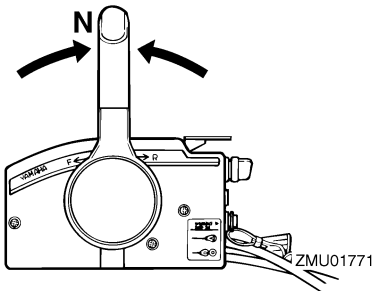

2. Slightly tilt the outboard motor up to the desired position using the power trim and tilt switch / power tilt switch.

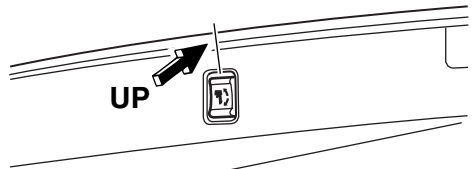
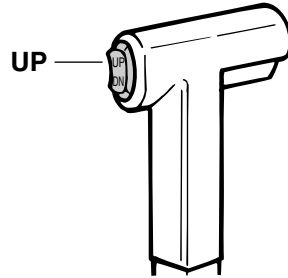

3. To return the outboard motor to the normal running position, press the power trim and tilt switch / power tilt switch and slowly tilt the outboard motor down.

EMU28192

## **Cruising in other conditions**

### **Cruising in salt water**

After operating in salt water, flush the cooling water passages with fresh water to prevent them from becoming clogged with salt deposits.

### **NOTE:**

For cooling system flushing instructions, see page 42.

### **Cruising in turbid water**

Yamaha strongly recommends that you use the optional chromium-plated water pump kit (not available for some models) if you use the outboard motor in turbid or muddy water conditions.

# Maintenance

---

EMU31480

## Specifications

### NOTE:

“(AL)” stated in the specification data below represents the numerical value for the aluminum propeller installed.

Likewise, “(SUS)” represents the value for stainless steel propeller installed and “(PL)” for plastic propeller installed.

---

EMU28218

### Dimension:

Overall length:

906 mm (35.7 in)

Overall width:

568 mm (22.4 in)

Overall height L:

1714 mm (67.5 in)

Transom height L:

493 mm (19.4 in)

Weight (SUS) L:

250.0 kg (551 lb)

### Performance:

Full throttle operating range:

5000–6000 r/min

Maximum output:

183.9 kW @ 5500 r/min (250

HP @ 5500 r/min)

Idling speed (in neutral):

700 ±30 r/min

### Engine:

Type:

2-stroke V

Displacement:

3342.0 cm<sup>3</sup> (203.93 cu.in)

Bore × stroke:

93.0 × 82.0 mm (3.66 × 3.23 in)

Ignition system:

TCI

Spark plug (NGK):

BKR6EKU

Spark plug gap:

1.5–1.6 mm (0.059–0.063 in)

Control system:

Remote control

Starting system:

Electric

Starting carburetion system:

Electronic fuel injection

Min. cold cranking amps (CCA/EN):

711.0 A

Min. rated capacity (20HR/IEC):

100.0 Ah

Alternator output for battery DC:

50.0 A

### Drive unit:

Gear positions:

Forward-neutral-reverse

Gear ratio:

1.75 (28/16)

Trim and tilt system:

Power trim and tilt

Propeller mark:

T

### Fuel and oil:

Recommended fuel:

Regular unleaded gasoline

Min. research octane:

90

Recommended engine oil:

YAMALUBE 2-stroke outboard motor oil

Lubrication:

Oil injection

Engine oil tank capacity:

1.2 L (1.27 US qt) (1.06 Imp.qt)

Remote oil tank capacity:

10.5 L (11.10 US qt) (9.24 Imp.qt)

Recommended gear oil:

Hypoid gear oil SAE#90

Gear oil quantity:

1050.0 cm<sup>3</sup> (35.50 US oz) (37.03

Imp.oz)

## Tightening torque for engine:

Spark plug:

25.0 Nm (18.4 ft-lb) (2.55 kgf-m)

Propeller nut:

55.0 Nm (40.6 ft-lb) (5.61 kgf-m)

EMU28222

## Transporting and storing outboard motor

EWM00690

### **WARNING**

- Leaking fuel is a fire hazard. When transporting and storing the outboard motor, close the air vent screw and fuel cock to prevent fuel from leaking.
- USE CARE when transporting fuel tank, whether in a boat or car.
- DO NOT fill fuel container to maximum capacity. Gasoline will expand considerably as it warms up and can build up pressure in the fuel container. This can cause fuel leakage and a potential fire hazard.

EWM00700

### **WARNING**

Never get under the lower unit while it is tilted, even if a motor support bar is used. Severe injury could occur if the outboard motor accidentally falls.

ECM00660

### **CAUTION:**

Do not use the tilt support lever or knob when trailering the boat. The outboard motor could shake loose from the tilt support and fall. If the motor cannot be trailered in the normal running position, use an additional support device to secure it in the tilt position.

The outboard motor should be trailered and stored in the normal running position. If there

is insufficient road clearance in this position, then trailer the outboard motor in the tilt position using a motor support device such as a transom saver bar. Consult your Yamaha dealer for further details.

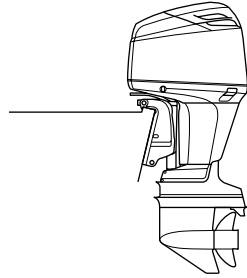

ZMU04720

EMU28270

## Storing outboard motor

When storing your Yamaha outboard motor for prolonged periods of time (2 months or longer), several important procedures must be performed to prevent expensive damage. This is especially important for your oil injection-equipped outboard motor due to the lean oil ratios used at idle prior to shutting the engine off for the season. It is advisable to have your outboard motor serviced by an authorized Yamaha dealer prior to storage. However, you, the owner, with a minimum of tools, can perform the following procedures.

ECM01100

### **CAUTION:**

- Do not use any chemical goods containing Silicon, Phosphorus, or Lead. Consult your Yamaha dealer for details on the use of chemical goods for storage.
- Drain the remaining gasoline from the vapor separator. Gasoline left in the vapor separator for a prolonged period of time will break down and could cause damage to the fuel line.

# Maintenance

EMU28303

## Procedure

EMU31900

### Engine anti-rust measure

ECM01530

#### **CAUTION:**

Do not perform this procedure while the engine is running. The water pump may be damaged and severe damage from overheating can result.

#### **NOTE:**

This procedure is performed while the top cowling is removed.

1. Remove the spark plug(s).
2. Pour a teaspoonful of clean engine oil into each cylinder.
3. Crank the engine several times manually.
4. Reinstall the spark plug(s).

EMU31380

### Draining the gasoline from the vapor separator

#### **NOTE:**

This procedure is performed while the top cowling is removed.

1. Drain the remaining gasoline in the vapor separator into a container. Loosen the drain screw, and then remove the cap. Push in the air valve with a screwdriver to introduce air into the float chamber, so that the gasoline will drain smoothly. Then, tighten the drain screw.

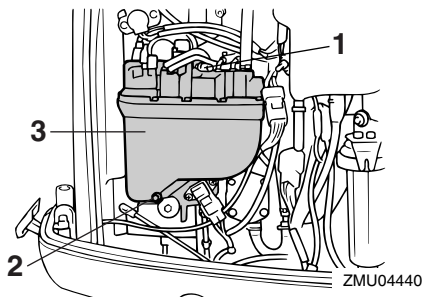

1. Air valve
2. Drain screw
3. Vapor separator

EMU31390

### Washing the outboard motor

#### **NOTE:**

This procedure is performed while the top cowling is installed.

1. Wash the outboard motor body using fresh water.
2. Drain the cooling water completely out of the motor. Clean the body thoroughly.

EMU28410

### Lubrication (oil injection models)

1. Grease the spark plug threads and install the spark plug(s) and torque to proper specification. For information on spark plug installation, see page 49.
2. Fill the oil tanks. This prevents the formation of condensation. For models with a remote oil tank, it may be necessary to manually override the control unit to completely fill the engine oil tank.
3. Change the gear oil. For instructions, see page 55. Inspect the oil for the presence of water which indicates a leaky seal. Seal replacement should be performed by an authorized Yamaha dealer prior to use.
4. Grease all grease fittings. For further de-



tails, see page 49.

EMU28430

## Battery care

EWM00330



**Battery electrolytic fluid is dangerous; it contains sulfuric acid and therefore is poisonous and highly caustic.**

**Always follow these preventive measures:**

- **Avoid bodily contact with electrolytic fluid as it can cause severe burns or permanent eye injury.**
- **Wear protective eye gear when handling or working near batteries.**

**Antidote (EXTERNAL):**

- **SKIN - Flush with water.**
- **EYES - Flush with water for 15 minutes and get immediate medical attention.**

**Antidote (INTERNAL):**

- **Drink large quantities of water or milk followed by milk of magnesia, beaten egg, or vegetable oil. Get immediate medical attention.**

**Batteries also generate explosive hydrogen gas; therefore, you should always follow these preventive measures:**

- **Charge batteries in a well-ventilated area.**
- **Keep batteries away from fire, sparks, or open flames (for example: welding equipment, lighted cigarettes, and so on.)**
- **DO NOT SMOKE when charging or handling batteries.**

**KEEP BATTERIES AND ELECTROLYTIC FLUID OUT OF REACH OF CHILDREN.**

Batteries vary among manufacturers. Therefore the following procedures may not always apply. Consult your battery manufacturer's instructions.

## Procedure

1. **Disconnect and remove the battery from the boat. Always disconnect the black negative cable first to prevent the risk of shorting.**
2. **Clean the battery casing and terminals. Fill each cell to the upper level with distilled water.**
3. **Store the battery on a level surface in a cool, dry, well-ventilated place out of direct sunlight.**
4. **Once a month, check the specific gravity of the electrolyte and recharge as required to prolong battery life.**

EMU28442

## Flushing power unit

Perform this procedure right after operation for the most thorough flushing.

ECM01530

## CAUTION:

**Do not perform this procedure while the engine is running. The water pump may be damaged and severe damage from overheating can result.**

1. **After shutting off the engine, unscrew the garden hose connector from the fitting on the bottom cowling.**

# Maintenance

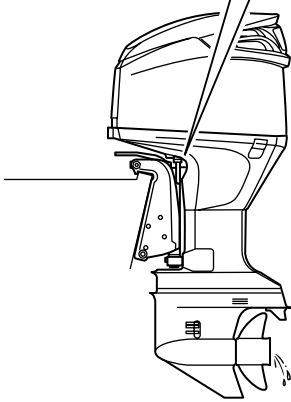
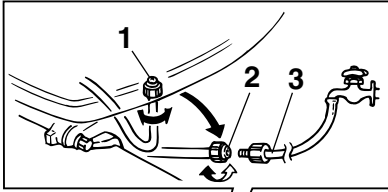

ZMU01984

1. Fitting

2. Garden hose connector

3. Garden hose adapter

2. Screw the garden hose adapter onto a garden hose, which is connected to a fresh water supply, and then connect it to the garden hose connector.
3. With the engine off, turn on the water tap and let the water flush through the cooling passages for about 15 minutes. Turn off the water and disconnect the garden hose adapter from the garden hose connector.
4. Reinstall the garden hose connector onto the fitting on the bottom cowling. Tighten the connector securely.

ECM00540

## CAUTION:

**Do not leave the garden hose connector loose on the bottom cowling fitting or let the hose hang free during normal opera-**

**tion. Water will leak out of the connector instead of cooling the engine, which can cause serious overheating. Be sure the connector is tightened securely on the fitting after flushing the engine.**

## NOTE:

- When flushing the engine with the boat in the water, tilting up the outboard motor until it is completely out of the water will achieve better results.
- For cooling system flushing instructions, see page 42.

EMU28450

## Cleaning the outboard motor

After use, wash the exterior of the outboard motor with fresh water. Flush the cooling system with fresh water.

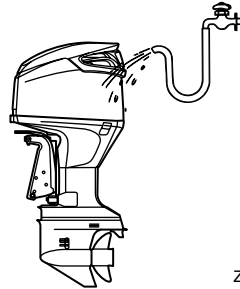

ZMU01985

## NOTE:

For cooling system flushing instructions, see page 42.

EMU28460

## Checking painted surface of motor

Check the motor for scratches, nicks, or flaking paint. Areas with damaged paint are more likely to corrode. If necessary, clean and paint the areas. A touch-up paint is available from your Yamaha dealer.

EMU28476

## Periodic maintenance

EWM01070



**Be sure to turn off the engine when you perform maintenance unless otherwise specified. If you or the owner is not familiar with machine servicing, this work should be done by your Yamaha dealer or other qualified mechanic.**

---

EMU28510

## Replacement parts

If replacement parts are necessary, use only genuine Yamaha parts or parts of the same type and of equivalent strength and materials. Any part of inferior quality may malfunction, and the resulting loss of control could endanger the operator and passengers. Yamaha genuine parts and accessories are available from your Yamaha dealer.

# Maintenance

EMU28522

## Maintenance chart

Frequency of maintenance operations may be adjusted according to the operating conditions, but the following table gives general guidelines. Refer to the sections in this chapter for explanations of each owner-specific action.

### NOTE:

When operating in salt water, turbid or muddy water, the engine should be flushed with clean water after each use.

The “●” symbol indicates the check-ups which you may carry out yourself.

The “○” symbol indicates work to be carried out by your Yamaha dealer.

Item	Actions	Initial		Every	
		10 hours (1 month)	50 hours (3 months)	100 hours (6 months)	200 hours (1 year)
Anode(s) (external)	Inspection / replacement		●/○	●/○	
Anode(s) (internal)	Inspection / replacement				○
Battery	Inspection / charging	●/○			
Cooling water passages	Cleaning		●	●	
Cowling clamp	Inspection				●
Fuel filter (can be disassembled)	Inspection / replacement	●	●	●	
Fuel system	Inspection	●	●	●	
Gear oil	Change	●		●	
Greasing points	Greasing			●	
Idling speed	Inspection				○
PCV (Pressure Control Valve)	Inspection				○
Power trim and tilt unit	Inspection				○
Propeller and cotter pin	Inspection / replacement		●	●	
Shift link / shift cable	Inspection / adjustment				○
Thermostat	Inspection / replacement				○
Throttle link / throttle cable / throttle pick-up timing	Inspection / adjustment				○
Throttle position sensor	Inspection / adjustment				○

# Maintenance

Item	Actions	Initial		Every	
		10 hours (1 month)	50 hours (3 months)	100 hours (6 months)	200 hours (1 year)
Water pump	Inspection / replacement				○
High pressure fuel pump drive belt	Inspection / replacement			○	○
High pressure fuel pump oil level	Inspection / filling				○
Oil pump	Inspection / adjustment	○			
Oil tank water drain	Inspection / cleaning	●/○	●/○	●/○	
Spark plug(s)	Cleaning / adjustment / replacement	●	●	●	

EMU28874

## Maintenance chart (additional)

Item	Actions	Every	
		500 hours (2.5 years)	1000 hours (5 years)
High pressure fuel pump drive belt	Replacement		○
Fuel filter (vapor separator tank)	Replacement		○

# Maintenance

EMU28940

## Greasing

Yamaha grease A (water resistant grease)

Yamaha grease D (corrosion resistant grease; for propeller shaft)

Z250F

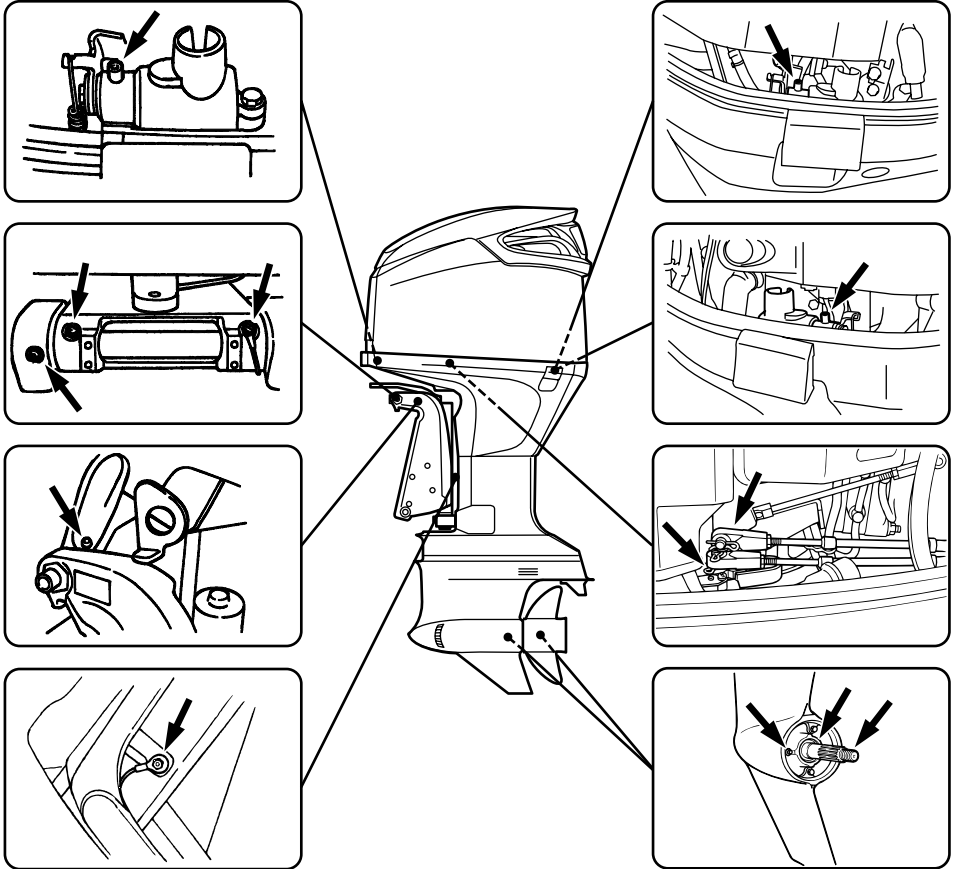

ZMU01986

EMU28952

## Cleaning and adjusting spark plug

EWM00560



**When removing or installing a spark plug, be careful not to damage the insulator. A**

**damaged insulator could allow external sparks, which could lead to explosion or fire.**

The spark plug is an important engine component and is easy to inspect. The condition

of the spark plug can indicate something about the condition of the engine. For example, if the center electrode porcelain is very white, this could indicate an intake air leak or carburetion problem in that cylinder. Do not attempt to diagnose any problems yourself. Instead, take the outboard motor to a Yamaha dealer. You should periodically remove and inspect the spark plug because heat and deposits will cause the spark plug to slowly break down and erode. If electrode erosion becomes excessive, or if carbon and other deposits are excessive, you should replace the spark plug with another of the correct type.

Standard spark plug:  
BKR6EKU

Before fitting the spark plug, measure the electrode gap with a wire thickness gauge; adjust the gap to specification if necessary.

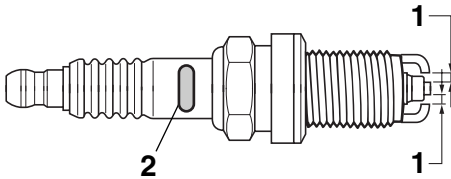

ZMU01892

1. Spark plug gap
2. Spark plug I.D. mark (NGK)

Spark plug gap:  
1.5–1.6 mm (0.059–0.063 in)

When fitting the plug, always clean the gasket surface and use a new gasket. Wipe off any dirt from the threads and screw in the

spark plug to the correct torque.

Spark plug torque:  
25.0 Nm (18.4 ft-lb) (2.55 kgf-m)

## NOTE:

If a torque-wrench is not available when you are fitting a spark plug, a good estimate of the correct torque is 1/4 to 1/2 a turn past finger-tight. Have the spark plug adjusted to the correct torque as soon as possible with a torque-wrench.

EMU28962

## Checking fuel system

EWM00060



**WARNING**

Gasoline and its vapors are highly flammable and explosive. Keep away from sparks, cigarettes, flames, or other sources of ignition.

EWM00910



**WARNING**

Leaking fuel can result in fire or explosion.

- Check for fuel leakage regularly.
- If any fuel leakage is found, the fuel system must be repaired by a qualified mechanic. Improper repairs can make the outboard unsafe to operate.

Check the fuel lines for leaks, crack, or malfunction. If a problem is found, your Yamaha dealer or other qualified mechanic should repair it immediately.

# Maintenance

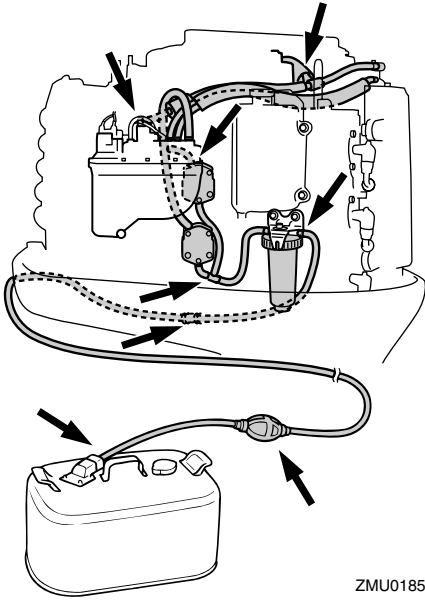

ZMU01853

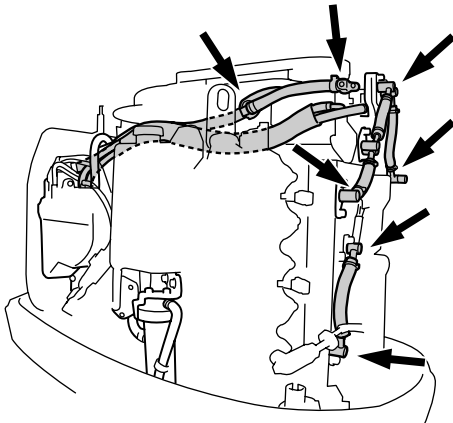

ZMU01955

- Fuel line joint leakage
- Fuel line cracks or other damage
- Fuel connector leakage

EMU29041

## Inspecting idling speed

EWM00451

### **WARNING**

- Do not touch or remove electrical parts when starting or during operation.
- Keep hands, hair, and clothes away from the flywheel and other rotating parts while the engine is running.

ECM00490

### **CAUTION:**

This procedure must be performed while the outboard motor is in the water. A flushing attachment or test tank can be used.

A diagnostic tachometer should be used for this procedure. Results may vary depending on whether testing is conducted with the flushing attachment, in a test tank, or with the outboard motor in the water.

1. Start the engine and allow it to warm up fully in neutral until it is running smoothly.

### **NOTE:**

Correct idling speed inspection is only possible if the engine is fully warmed up. If not warmed up fully, the idle speed will measure higher than normal. If you have difficulty verifying the idle speed, or the idle speed requires adjustment, consult a Yamaha dealer or other qualified mechanic.

2. Verify whether the idle speed is set to specification. For idle speed specifications, see page 41.

## Checkpoints

- Fuel system parts leakage



EMU29050

## Checking water in engine oil tank

### Oil injection models

There is a water trap at the bottom of the engine oil tank. If water or foreign matter is visible in this trap, consult your Yamaha dealer.

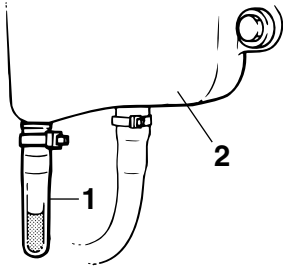

ZMU01895

1. Water trap
2. Engine oil tank

EMU29112

## Checking wiring and connectors

- Check that each grounding wire is properly secured.
- Check that each connector is engaged securely.

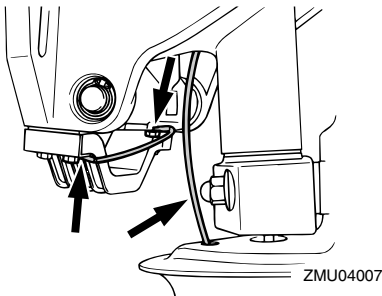

ZMU04007

EMU29120

## Exhaust leakage

Start the engine and check that no exhaust leaks from the joints between the exhaust cover, cylinder head, and body cylinder.

EMU29130

## Water leakage

Start the engine and check that no water leaks from the joints between the exhaust cover, cylinder head, and body cylinder.

EMU29153

## Checking power trim and tilt system

EWM00430

### **WARNING**

- Never get under the lower unit while it is tilted, even when the tilt support lever is locked. Severe injury could occur if the outboard motor accidentally falls.
- Make sure no one is under the outboard motor before performing this test.

1. Check the power trim and tilt unit for any sign of oil leaks.
2. Operate each of the power trim and tilt switches on the remote control and engine bottom cowling (if equipped) to check that all switches work.
3. Tilt the outboard motor up and check that the tilt rod and trim rods are extended completely.

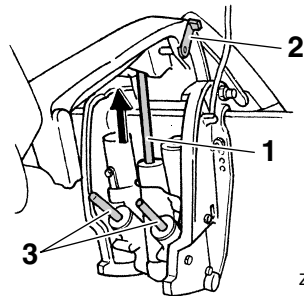

ZMU01940

1. Tilt rod
2. Tilt support lever
3. Trim rods
4. Use the tilt support lever to lock the motor in the up position. Operate the tilt down switch briefly so the motor is sup-

# Maintenance

ported by the tilt support lever.

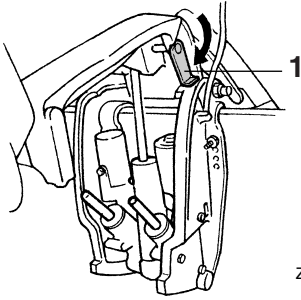

ZMU04935

1. Tilt support lever
5. Check that the tilt rod and trim rods are free of corrosion or other flaws.
6. Activate the tilt-down switch until the trim rods have retracted completely into the cylinders.

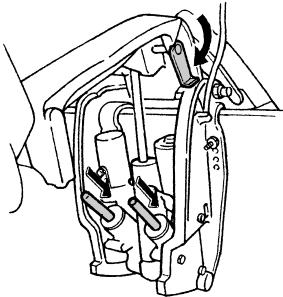

ZMU01941

7. Activate the trim-up switch until the tilt rod is fully extended. Unlock the tilt support lever.

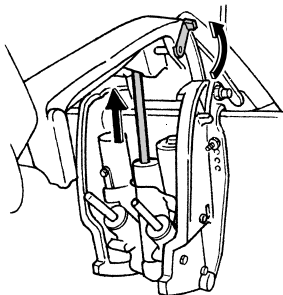

ZMU04936

8. Tilt the outboard motor down. Check that the tilt rod and trim rods operate smoothly.

## NOTE:

Consult your Yamaha dealer if any operation is abnormal.

EMU29171

## Checking propeller

EWM00321

### **WARNING**

You could be seriously injured if the engine accidentally starts when you are near the propeller.

- Before inspecting, removing, or installing the propeller, remove the spark plug caps from the spark plugs. Also, place the shift control in neutral, turn the main switch to "OFF" (off) and remove the key, and remove the lanyard from the engine stop switch. Turn off the battery cut-off switch if your boat has one.
- Do not use your hand to hold the propeller when loosening or tightening the propeller nut. Put a wood block between the anti-cavitation plate and the propeller to prevent the propeller from turning.

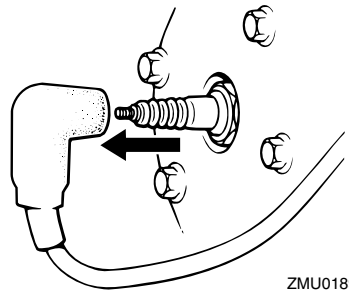

ZMU01896

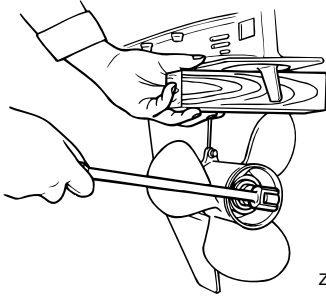

ZMU01897

## Checkpoints

- Check each of the propeller blades for wear, erosion from cavitation or ventilation, or other damage.
- Check the propeller shaft for damage.
- Check the splines / shear pin for wear or damage.
- Check for fish line tangled around the propeller shaft.

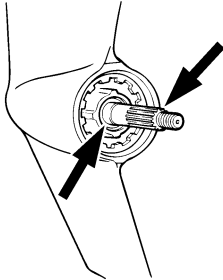

ZMU01803

- Check the propeller shaft oil seal for damage.

## NOTE: \_\_\_\_\_

If the shear pin equipped: it is designed to break if the propeller hits a hard underwater obstacle to help protect the propeller and drive mechanism. The propeller will then spin freely on the shaft. If this happens, the shear pin must be replaced.

---

EMU30660

## Removing the propeller

EMU29194

### Spline models

1. Straighten the cotter pin and pull it out using a pair of pliers.
2. Remove the propeller nut, washer, and spacer (if equipped).

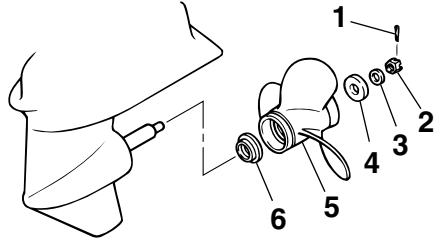

ZMU01898

1. Cotter pin
2. Propeller nut
3. Washer
4. Spacer
5. Propeller
6. Thrust washer

3. Remove the propeller and thrust washer.

EMU30670

## Installing the Propeller

EMU29231

### Spline models

ECM00340

## CAUTION:

- Be sure to install the thrust washer before installing the propeller, otherwise the lower case and propeller boss could be damaged.
  - Be sure to use a new cotter pin and bend the ends over securely. Otherwise the propeller could come off during operation and be lost.
- 

1. Apply Yamaha marine grease or a cor-

# Maintenance

rosion resistant grease to the propeller shaft.

2. Install the spacer (if equipped), thrust washer, and propeller on the propeller shaft.
3. Install the spacer (if equipped) and the washer. Tighten the propeller nut to the specified torque.
4. Align the propeller nut with the propeller shaft hole. Insert a new cotter pin in the hole and bend the cotter pin ends.

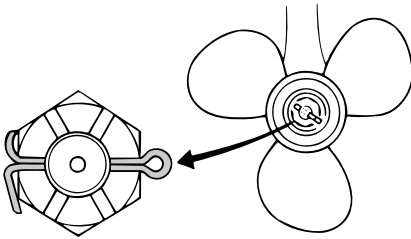

ZMU02063

## NOTE:

If the propeller nut does not align with the propeller shaft hole after tightening to the specified torque, tighten the nut further to align it with the hole.

EMU29291

## Changing gear oil

EWM00800

### **WARNING**

- Be sure the outboard motor is securely fastened to the transom or a stable stand. You could be severely injured if the outboard motor falls on you.
- Never get under the lower unit while it is tilted, even when the tilt support lever or knob is locked. Severe injury could occur if the outboard motor accidentally falls.

1. Tilt the outboard motor so that the gear

oil drain screw is at the lowest point possible.

2. Place a suitable container under the gear case.
3. Remove the cooling water inlet covers on both sides of the gear case. Be careful not to lose the bolt and nut.
4. Remove the gear oil drain screw.

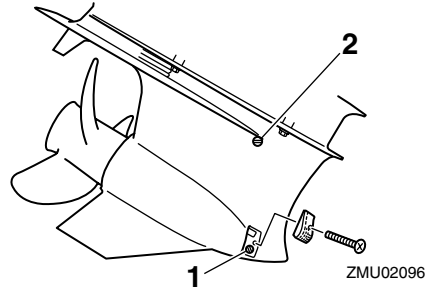

1. Gear oil drain screw
2. Oil level plug

## NOTE:

The gear oil drain screw is magnetic. Remove all metal particles from the screw before installing it.

5. Remove the oil level plug to allow the oil to drain completely.

ECM00710

### **CAUTION:**

Inspect the used oil after it has been drained. If the oil is milky, water is getting into the gear case which can cause gear damage. Consult a Yamaha dealer for repair of the lower unit seals.

## NOTE:

For disposal of used oil consult your Yamaha dealer.

6. With the outboard motor in a vertical position, and using a flexible or pressur-

ized filling device, inject the gear oil into the gear oil drain screw hole.

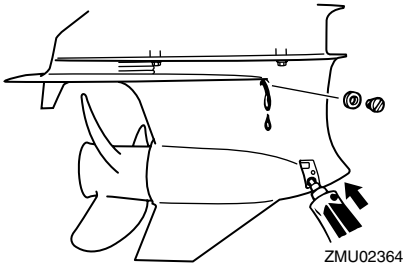

Recommended gear oil:  
Hypoid gear oil SAE#90  
Gear oil quantity:  
1050.0 cm<sup>3</sup> (35.50 US oz) (37.03  
Imp.oz)

7. When the oil begins to flow out of the oil level plug hole, insert and tighten the oil level plug.
8. Insert and tighten the gear oil drain screw.
9. Securely install the cooling water inlet covers on both sides of the gear case using the bolt and nut removed earlier.

EMU29312

## Inspecting and replacing anode(s)

Yamaha outboard motors are protected from corrosion by sacrificial anodes. Inspect the external anodes periodically. Remove scales from the surfaces of the anodes. Consult a Yamaha dealer for replacement of external anodes.

ECM00720

**CAUTION:** \_\_\_\_\_  
Do not paint anodes, as this would render them ineffective.

**NOTE:** \_\_\_\_\_

Inspect ground leads attached to external anodes on equipped models. Consult a

Yamaha dealer for inspection and replacement of internal anodes attached to the power unit.

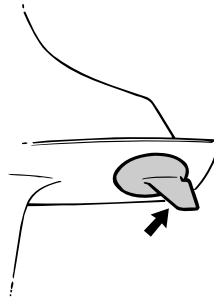

ZMU01901

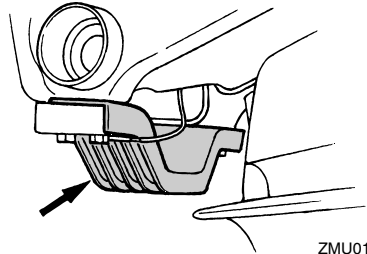

ZMU01902

EMU29320

## Checking battery (for electric start models)

EWM00330



**WARNING**

**Battery electrolytic fluid is dangerous; it contains sulfuric acid and therefore is poisonous and highly caustic.**

**Always follow these preventive measures:**

- Avoid bodily contact with electrolytic fluid as it can cause severe burns or permanent eye injury.
- Wear protective eye gear when han-

# Maintenance

---

dling or working near batteries.

**Antidote (EXTERNAL):**

- **SKIN** - Flush with water.
- **EYES** - Flush with water for 15 minutes and get immediate medical attention.

**Antidote (INTERNAL):**

- Drink large quantities of water or milk followed by milk of magnesia, beaten egg, or vegetable oil. Get immediate medical attention.

**Batteries also generate explosive hydrogen gas; therefore, you should always follow these preventive measures:**

- Charge batteries in a well-ventilated area.
- Keep batteries away from fire, sparks, or open flames (for example: welding equipment, lighted cigarettes, and so on.)
- **DO NOT SMOKE** when charging or handling batteries.

**KEEP BATTERIES AND ELECTROLYTIC FLUID OUT OF REACH OF CHILDREN.**

---

ECM00360

**CAUTION:** \_\_\_\_\_

- A poorly maintained battery will quickly deteriorate.
  - Ordinary tap water contains minerals harmful to a battery, and should not be used for topping up.
- 

1. Check the electrolyte level at least once a month. Fill to the manufacturer's recommended level when necessary. Top up only with distilled water (or pure de-ionized water suitable to use in batteries).

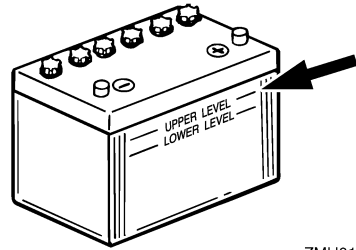

ZMU01810

2. Always keep the battery in a good state of charge. Installing a voltmeter will help you monitor your battery. If you will not use the boat for a month or more, remove the battery from the boat and store it in a cool, dark place. Completely recharge the battery before using it.
3. If the battery will be stored for longer than a month, check the specific gravity of the fluid at least once a month and recharge the battery when it is low.

**NOTE:** \_\_\_\_\_

Consult a Yamaha dealer when charging or re-charging batteries.

---

EMU29362

## Connecting the Battery

EWM00570

**WARNING** \_\_\_\_\_

**Mount the battery holder securely in a dry, well-ventilated, vibration-free location in the boat. Install a fully charged battery in the holder.**

---

ECM01121

**CAUTION:** \_\_\_\_\_

- Make sure the main switch (on applicable models) is "OFF" (off) before working on the battery.
- Reversal of the battery cables will damage the electrical parts.
- Connect the red battery cable first

when installing the battery and disconnect the black battery cable first when removing it. Otherwise, the electrical parts can be damaged.

- The electrical contacts of the battery and cables must be clean and properly connected, or the battery will not start the engine.

Connect the RED lead to the POSITIVE (+) terminal first. Then connect the BLACK lead to the NEGATIVE (-) terminal.

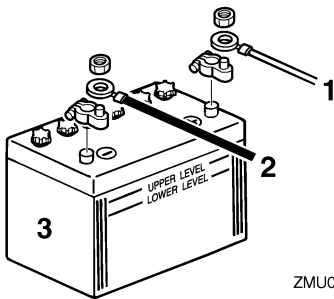

1. Red cable
2. Black cable
3. Battery

### Connecting an accessory battery (option)

1. Remove the accessory battery coupler cover from the outboard motor.

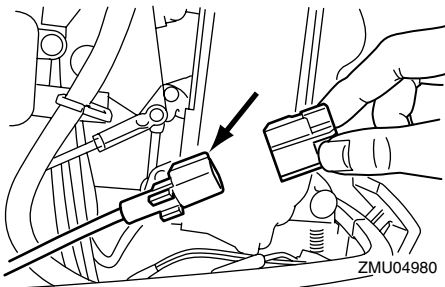

2. Connect the accessory battery coupler to the coupler of the accessory battery

lead (option). Use a connecting cable between the (-) terminals of the starting battery and accessory battery. See the illustrations of the wiring connections. This cable must be made from wire thicker than the starting battery cable.

EWM00600



**Use of smaller wire could lead to a fire.**

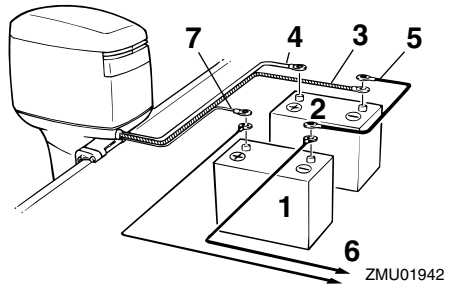

1. Battery for accessories
2. Battery for starting
3. Large black lead
4. Large red lead for starting battery
5. Negative connecting cable
6. Power for accessories
7. Small red lead for accessory battery charging (optional part)

### NOTE:

If a battery selector switch is desired, consult your Yamaha dealer about correct wiring.

EMU29370

### Disconnecting the battery

Disconnect the BLACK cable from the NEGATIVE (-) terminal first. Then disconnect the RED cable from the POSITIVE (+) terminal.

EMU29390

### Checking top cowling

Check the fitting of the top cowling by pushing it with both hands. If it is loose have it repaired by your Yamaha dealer.

# Maintenance

---

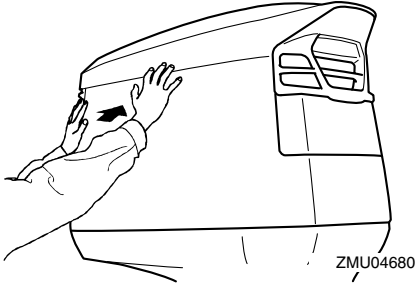

ZMU04680

EMU29400

## Coating the boat bottom

A clean hull improves boat performance. The boat bottom should be kept as clean of marine growth as possible. If necessary, the boat bottom can be coated with an anti-fouling paint approved for your area to inhibit marine growth.

Do not use anti-fouling paint which includes copper or graphite. These paints can cause more rapid engine corrosion.

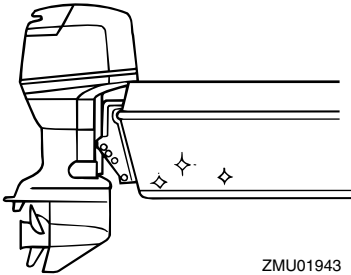

ZMU01943



EMU29424

## Troubleshooting

A problem in the fuel, compression, or ignition systems can cause poor starting, loss of power, or other problems. This section describes basic checks and possible remedies, and covers all Yamaha outboard motors. Therefore some items may not apply to your model.

If your outboard motor requires repair, bring it to your Yamaha dealer.

If the engine trouble warning indicator is flashing, consult your Yamaha dealer.

### **Starter will not operate.**

Q. Is battery capacity weak or low?

A. Check battery condition. Use battery of recommended capacity.

Q. Are battery connections loose or corroded?

A. Tighten battery cables and clean battery terminals.

Q. Is fuse for electric start relay or electric circuit blown?

A. Check for cause of electric overload and repair. Replace fuse with one of correct amperage.

Q. Are starter components faulty?

A. Have serviced by a Yamaha dealer.

Q. Is shift lever in gear?

A. Shift to neutral.

### **Engine will not start (starter operates).**

Q. Is fuel tank empty?

A. Fill tank with clean, fresh fuel.

Q. Is fuel contaminated or stale?

A. Fill tank with clean, fresh fuel.

Q. Is fuel filter clogged?

A. Clean or replace filter.

Q. Is starting procedure incorrect?

A. See page 32.

Q. Has fuel pump malfunctioned?

A. Have serviced by a Yamaha dealer.

Q. Are spark plug(s) fouled or of incorrect type?

A. Inspect spark plug(s). Clean or replace with recommended type.

Q. Are spark plug cap(s) fitted incorrectly?

A. Check and re-fit cap(s).

Q. Is ignition wiring damaged or poorly connected?

A. Check wires for wear or breaks. Tighten all loose connections. Replace worn or broken wires.

Q. Are ignition parts faulty?

A. Have serviced by a Yamaha dealer.

Q. Is engine stop switch lanyard not attached?

A. Attach lanyard.

Q. Are engine inner parts damaged?

A. Have serviced by a Yamaha dealer.

### **Engine idles irregularly or stalls.**

Q. Are spark plug(s) fouled or of incorrect type?

A. Inspect spark plug(s). Clean or replace with recommended type.

# Trouble Recovery

---

Q. Is fuel system obstructed?

A. Check for pinched or kinked fuel line or other obstructions in fuel system.

Q. Is fuel contaminated or stale?

A. Fill tank with clean, fresh fuel.

Q. Is fuel filter clogged?

A. Clean or replace filter.

Q. Have ignition parts failed?

A. Have serviced by a Yamaha dealer.

Q. Has warning system activated?

A. Find and correct cause of warning.

Q. Is spark plug gap incorrect?

A. Inspect and adjust as specified.

Q. Is ignition wiring damaged or poorly connected?

A. Check wires for wear or breaks. Tighten all loose connections. Replace worn or broken wires.

Q. Is specified engine oil not being used?

A. Check and replace oil as specified.

Q. Is thermostat faulty or clogged?

A. Have serviced by a Yamaha dealer.

Q. Are carburetor adjustments incorrect?

A. Have serviced by a Yamaha dealer.

Q. Is fuel pump damaged?

A. Have serviced by a Yamaha dealer.

Q. Is air vent screw on fuel tank closed?

A. Open air vent screw.

Q. Is choke knob pulled out?

A. Return to home position.

Q. Is motor angle too high?

A. Return to normal operating position.

Q. Is carburetor clogged?

A. Have serviced by a Yamaha dealer.

Q. Is fuel joint connection incorrect?

A. Connect correctly.

Q. Is throttle valve adjustment incorrect?

A. Have serviced by a Yamaha dealer.

Q. Is battery cable disconnected?

A. Connect securely.

## **Warning buzzer sounds or indicator lights.**

Q. Is cooling system clogged?

A. Check water intake for restriction.

Q. Is engine oil level low?

A. Fill oil tank with specified engine oil.

Q. Is heat range of spark plug incorrect?

A. Inspect spark plug and replace it with recommended type.

Q. Is specified engine oil not being used?

A. Check and replace oil with specified type.

Q. Is engine oil contaminated or deteriorated?

A. Replace oil with fresh, specified type.

Q. Is oil filter clogged?

A. Have serviced by a Yamaha dealer.

Q. Has oil feed/injection pump malfunctioned?

# Trouble Recovery

A. Have serviced by a Yamaha dealer.

Q. Is load on boat improperly distributed?

A. Distribute load to place boat on an even plane.

Q. Is water pump or thermostat faulty?

A. Have serviced by a Yamaha dealer.

Q. Is there excess water in fuel filter cup?

A. Drain filter cup.

## Engine power loss.

Q. Is propeller damaged?

A. Have propeller repaired or replaced.

Q. Is propeller pitch or diameter incorrect?

A. Install correct propeller to operate outboard at its recommended speed (r/min) range.

Q. Is trim angle incorrect?

A. Adjust trim angle to achieve most efficient operation.

Q. Is motor mounted at incorrect height on transom?

A. Have motor adjusted to proper transom height.

Q. Has warning system activated?

A. Find and correct cause of warning.

Q. Is boat bottom fouled with marine growth?

A. Clean boat bottom.

Q. Are spark plug(s) fouled or of incorrect type?

A. Inspect spark plug(s). Clean or replace with recommended type.

Q. Are weeds or other foreign matter tangled on gear housing?

A. Remove foreign matter and clean lower unit.

Q. Is fuel system obstructed?

A. Check for pinched or kinked fuel line or other obstructions in fuel system.

Q. Is fuel filter clogged?

A. Clean or replace filter.

Q. Is fuel contaminated or stale?

A. Fill tank with clean, fresh fuel.

Q. Is spark plug gap incorrect?

A. Inspect and adjust as specified.

Q. Is ignition wiring damaged or poorly connected?

A. Check wires for wear or breaks. Tighten all loose connections. Replace worn or broken wires.

Q. Have electrical parts failed?

A. Have serviced by a Yamaha dealer.

Q. Is specified fuel not being used?

A. Replace fuel with specified type.

Q. Is specified engine oil not being used?

A. Check and replace oil with specified type.

Q. Is thermostat faulty or clogged?

A. Have serviced by a Yamaha dealer.

Q. Is air vent screw closed?

A. Open the air vent screw.

Q. Is fuel pump damaged?

A. Have serviced by a Yamaha dealer.

# Trouble Recovery

---

Q. Is fuel joint connection incorrect?

A. Connect correctly.

Q. Is heat range of spark plug incorrect?

A. Inspect spark plug and replace it with recommended type.

Q. Is high pressure fuel pump drive belt broken?

A. Have serviced by a Yamaha dealer.

Q. Is engine not responding properly to shift lever position?

A. Have serviced by a Yamaha dealer.

## Engine vibrates excessively.

Q. Is propeller damaged?

A. Have propeller repaired or replaced.

Q. Is propeller shaft damaged?

A. Have serviced by a Yamaha dealer.

Q. Are weeds or other foreign matter tangled on propeller?

A. Remove and clean propeller.

Q. Is motor mounting bolt loose?

A. Tighten bolt.

Q. Is steering pivot loose or damaged?

A. Tighten or have serviced by a Yamaha dealer.

EMU29433

## Temporary action in emergency

EMU29440

### Impact damage

EWM00870



The outboard motor can be seriously

**damaged by a collision while operating or trailering. Damage could make the outboard motor unsafe to operate.**

---

If the outboard motor hits an object in the water, follow the procedure below.



1. Stop the engine immediately.
2. Inspect the control system and all components for damage. Also inspect the boat for damage.
3. Whether damage is found or not, return to the nearest harbor slowly and carefully.
4. Have a Yamaha dealer inspect the outboard motor before operating it again.

EMU29462

### Replacing fuse

If the fuse has blown on an electric start model, open the fuse holder and replace the fuse with a new one of the proper amperage.

EWM00630



**Be sure to use the specified fuse. An incorrect fuse or a piece of wire could allow excessive current flow. This could cause electric system damage and a fire hazard.**

---

# Trouble Recovery

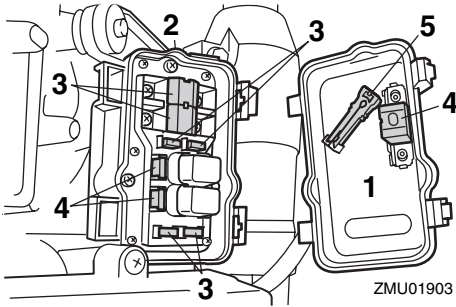

1. Electrical cover
2. Fuse holder
3. Fuse (20 A, 30 A, 100 A)
4. Spare fuse (20 A, 30 A, 100 A)
5. Fuse puller

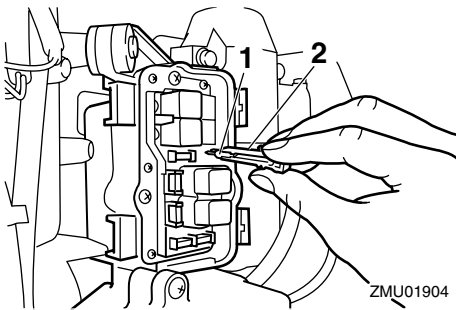

1. Fuse (20 A, 30 A, 100 A)
2. Fuse puller

## NOTE:

Consult your Yamaha dealer if the new fuse immediately blows again.

EMU29522

## Power trim and tilt / power tilt will not operate

If the engine cannot be tilted up or down with the power trim and tilt / the power tilt because of a discharged battery or a failure with the power trim and tilt unit / the power tilt unit, the engine can be tilted manually.

1. Loosen the manual valve screw by turn-

ing it counterclockwise until it stops.

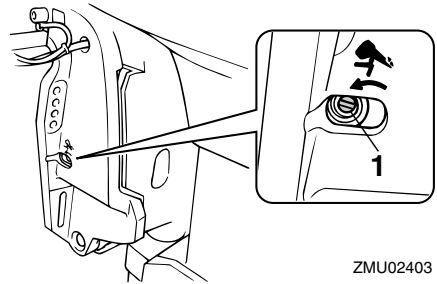

1. Manual valve screw
2. Put the engine in the desired position, then tighten the manual valve screw by turning it clockwise.

EMU31780

## Water separator warning indicator blinks while cruising

EWM01500

### **WARNING**

Gasoline is highly flammable, and its vapors are flammable and explosive.

- Do not perform this procedure on a hot or running engine. Allow the engine to cool.
- There will be fuel in the fuel filter. Keep away from sparks, cigarettes, flames or other sources of ignition.
- This procedure will allow some fuel to spill. Catch fuel in a rag. Wipe up any spilled fuel immediately.
- The fuel filter must be reassembled carefully with the O-ring, filter cup, and hoses in place. Improper assembly or replacement could result in a fuel leak, which could result in a fire or explosion hazard.

If the water separator warning indicator on the tachometer blinks, perform the following procedure.

# Trouble Recovery

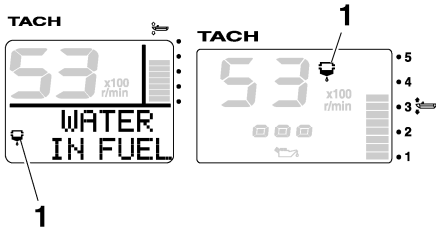

ZMU05442

1. Water separator warning indicator

1. Stop the engine.
2. Remove the top cowling.
3. Disconnect the water detection switch coupler.

ECM01570

## CAUTION:

Be careful not to get any water on the water detection switch coupler, otherwise a malfunction could occur.

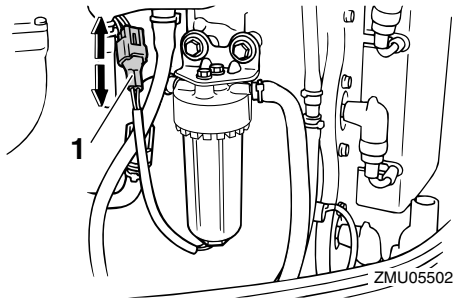

ZMU05502

1. Water detection switch coupler

4. Unscrew the filter cup from the filter housing.

## NOTE:

Be careful not to twist the water detection switch lead when unscrewing the filter cup.

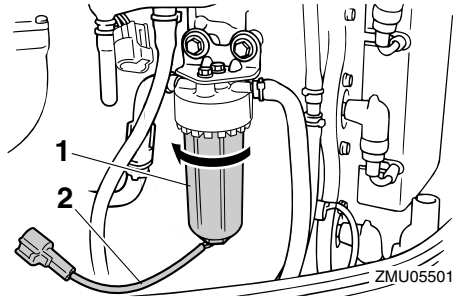

ZMU05501

1. Filter cup
2. Water detection switch lead

5. Drain the water in the filter cup by soaking it up with a rag.

## NOTE:

Properly dispose of the rag.

6. Firmly screw the filter cup onto the filter housing.

## NOTE:

Be careful not to twist the water detection switch lead when screwing the filter cup onto the filter housing.

7. Connect the water detection switch coupler securely until a click is heard.

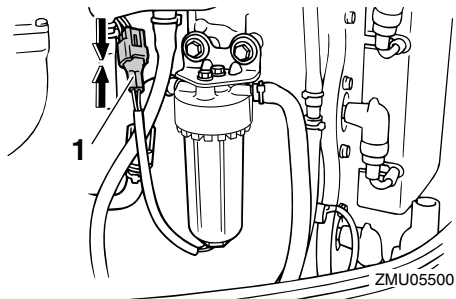

ZMU05500

1. Water detection switch coupler

8. Install the top cowling.
9. Start the engine and make sure that the water separator warning indicator re-

mains off.

**NOTE:** \_\_\_\_\_

Have a Yamaha dealer inspect the outboard motor after returning to port.

EMU29670

## Engine fails to operate

EMU29741

### Low oil level warning activates

If the oil level is allowed to drop too low, the red segment will appear on the oil level indicator, the buzzer will sound, and engine speed will be limited to about 2000 r/min. If this happens, a reserve amount of oil can be pumped from the remote oil tank to the engine oil tank using the emergency switch.

EWM01050

**WARNING** \_\_\_\_\_

Be sure to stop the engine before performing this procedure.

ECM00900

**CAUTION:** \_\_\_\_\_

- If the emergency switch is held up too long, too much oil will be pumped into the engine oil tank, overflowing it. Release the switch when oil reaches the upper level line on the engine oil tank.
- Do not use this emergency procedure unless the oil level warning indicators are working.

1. Remove the top cowling.
2. Turn on the main switch.

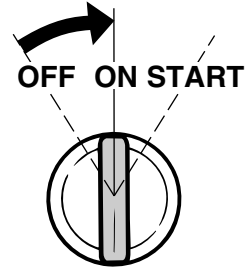

ZMU01906

3. Lift the emergency switch to pump reserve oil into the engine oil tank from the remote oil tank.

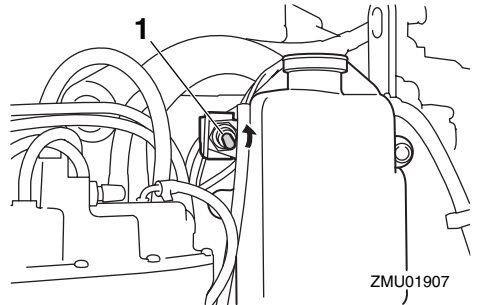

ZMU01907

1. Emergency switch

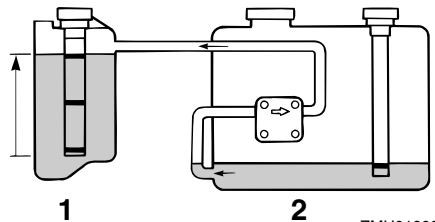

ZMU01908

1. Engine oil tank
  2. Remote oil tank
4. After using the emergency switch, turn off the main switch, then turn it back on. This resets the warning system to nor-

# Trouble Recovery

---

mal operation. The yellow segment will continue to be displayed on the oil level indicator.

5. Start the engine and return to the nearest port for more oil.

## NOTE:

- The maximum reserve oil capacity is 1500 cm<sup>3</sup> (1.6 US qt, 1.31 Imp qt).
- The oil-feed pump will not operate if the engine is tilted up more than 35°. Put the engine in the upright position (not tilted) before using the emergency switch.

EMU29760

## Treatment of submerged motor

If the outboard motor is submerged, immediately take it to a Yamaha dealer. Otherwise some corrosion may begin almost immediately.

If you cannot immediately take the outboard motor to a Yamaha dealer, follow the procedure below in order to minimize engine damage.

EMU29970

## Procedure

1. Thoroughly wash away mud, salt, seaweed, and so on, with fresh water.



ZMU01909

2. Remove the spark plugs and face the spark plug holes downward to allow any water, mud, or contaminants to drain.

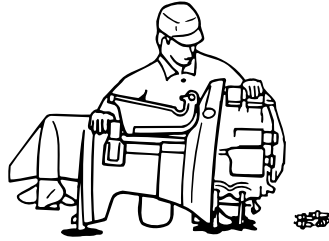

ZMU01910

3. Drain the fuel from the vapor separator, fuel filter, and fuel line.
4. Spray "Fogging Oil" or supply engine oil through the intake manifold and spark plug holes while rotating the flywheel manually.

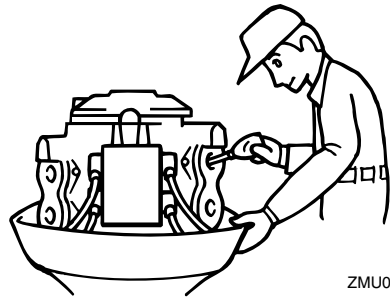

ZMU01911

5. Take the outboard motor to a Yamaha dealer as soon as possible.

ECM00400

## CAUTION:

**Do not attempt to run the outboard motor until it has been completely inspected.**

---







YAMAHA MOTOR CO., LTD.

Printed in Japan

April 2006-0.1 × 1 

Printed on recycled paper