



OWNER'S MANUAL

Majesty

YP250

5SJ-28199-E0

Welcome to the Yamaha world of motorcycling!

As the owner of the YP250, you are benefiting from Yamaha's vast experience and newest technology regarding the design and manufacture of high-quality products, which have earned Yamaha a reputation for dependability.

Please take the time to read this manual thoroughly, so as to enjoy all advantages of your YP250. The owner's manual does not only instruct you in how to operate, inspect and maintain your scooter, but also in how to safeguard yourself and others from trouble and injury.

In addition, the many tips given in this manual will help keep your scooter in the best possible condition. If you have any further questions, do not hesitate to contact your Yamaha dealer.

The Yamaha team wishes you many safe and pleasant rides. So, remember to put safety first!

IMPORTANT MANUAL INFORMATION

Particularly important information is distinguished in this manual by the following notations:



The Safety Alert Symbol means ATTENTION! BECOME ALERT! YOUR SAFETY IS INVOLVED!

WARNING

Failure to follow WARNING instructions could result in severe injury or death to the scooter operator, a bystander, or a person inspecting or repairing the scooter.

CAUTION:

A CAUTION indicates special precautions that must be taken to avoid damage to the scooter.

NOTE:

A NOTE provides key information to make procedures easier or clearer.

NOTE:

- This manual should be considered a permanent part of this scooter and should remain with it even if the scooter is subsequently sold.
 - Yamaha continually seeks advancements in product design and quality. Therefore, while this manual contains the most current product information available at the time of printing, there may be minor discrepancies between your scooter and this manual. If you have any questions concerning this manual, please consult your Yamaha dealer.
-

IMPORTANT MANUAL INFORMATION

EW000002

⚠️ WARNING

PLEASE READ THIS MANUAL CAREFULLY AND COMPLETELY BEFORE OPERATING THIS SCOOTER.

EAU04229

**YP250
OWNER'S MANUAL
©2001 by Yamaha Motor Co., Ltd.
1st edition, December 2001
All rights reserved.
Any reprinting or unauthorized use
without the written permission of
Yamaha Motor Co., Ltd.
is expressly prohibited.
Printed in Japan.**

TABLE OF CONTENTS

1 GIVE SAFETY THE RIGHT OF WAY

1

2 DESCRIPTION

2

3 INSTRUMENT AND CONTROL FUNCTIONS

3

4 PRE-OPERATION CHECKS

4

5 OPERATION AND IMPORTANT RIDING POINTS

5

6 PERIODIC MAINTENANCE AND MINOR REPAIR

6

7 SCOOTER CARE AND STORAGE

7

8 SPECIFICATIONS

8

9 CONSUMER INFORMATION

9

INDEX



GIVE SAFETY THE RIGHT OF WAY

| | |
|------------------------------------|-----|
| GIVE SAFETY THE RIGHT OF WAY | 1-1 |
| Further safe-riding points | 1-2 |



GIVE SAFETY THE RIGHT OF WAY

1

Scooters are fascinating vehicles, which can give you an unsurpassed feeling of power and freedom. However, they also impose certain limits, which you must accept; even the best scooter does not ignore the laws of physics.

Regular care and maintenance are essential for preserving value and operating condition of your scooter. Moreover, what is true for the scooter is also true for the rider: good performance depends on being in good shape. Riding under the influence of medication, drugs and alcohol is, of course, out of the question. Scooter riders—more than car drivers—must always be at their mental and physical best. Under the influence of even small amounts of alcohol, there is a tendency to take dangerous risks.

Protective clothing is as essential for the scooter rider as seat belts are for car drivers and passengers. Always wear a complete motorcycle suit (whether made of leather or tear-resistant synthetic materials with protectors), sturdy boots, motorcycle gloves and a properly fitting helmet. Optimum protective wear, however, should not encourage carelessness. Although full-coverage helmets and suits, in particular, create an illusion of total safety and protection, motorcyclists will always be vulnerable. Riders who lack critical self-control run the risk of going too fast and are apt to take chances. This is even more dangerous in wet weather. The good motorcyclist rides safely, predictably and defensively—avoiding all dangers, including those caused by others.

Enjoy your ride!



Further safe-riding points

- Be sure to signal clearly when making turns.
- Braking can be extremely difficult on a wet road. Avoid hard braking, because the scooter could slide. Apply the brakes slowly when stopping on a wet surface.
- Slow down as you approach a corner or turn. Once you have completed a turn, accelerate slowly.
- Be careful when passing parked cars. A driver might not see you and open a door in your path.
- Railroad crossings, streetcar rails, iron plates on road construction sites, and manhole covers become extremely slippery when wet. Slow down and cross them with caution. Keep the scooter upright, otherwise it could slide out from under you.
- The brake pads could get wet when you wash the scooter. After washing the scooter, check the brakes before riding.
- Always wear a helmet, gloves, trousers (tapered around the cuff and ankle so they do not flap), and a bright colored jacket.
- Do not carry too much luggage on the scooter. An overloaded scooter is unstable.

| | |
|--------------------------------|-----|
| Left view | 2-1 |
| Right view | 2-2 |
| Controls and instruments | 2-3 |

DESCRIPTION

Left view

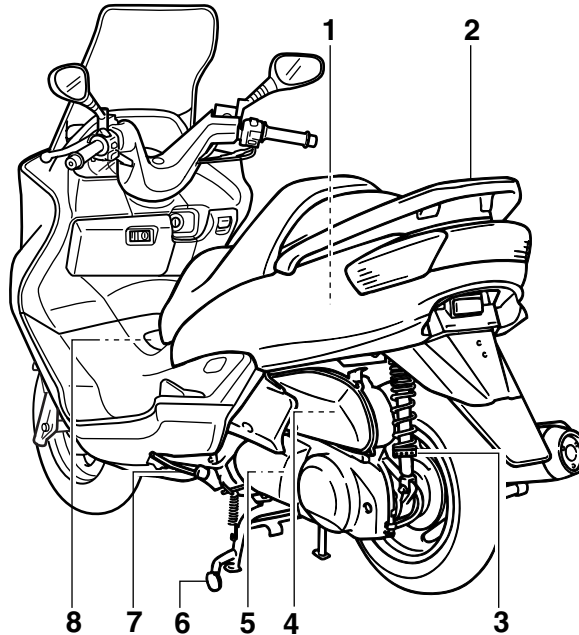

- | | | | |
|--|-------------|-----------------------------------|-------------------|
| 1. Rear storage compartment | (page 3-18) | 5. V-belt case air filter element | (page 6-22) |
| 2. Grab bar | (page 5-2) | 6. Centerstand | (page 6-31) |
| 3. Shock absorber spring preload adjusting ring | (page 3-19) | 7. Sidestand | (page 3-20, 6-31) |
| 4. Air filter element | (page 6-21) | 8. Fuel tank cap | (page 3-13) |

Right view

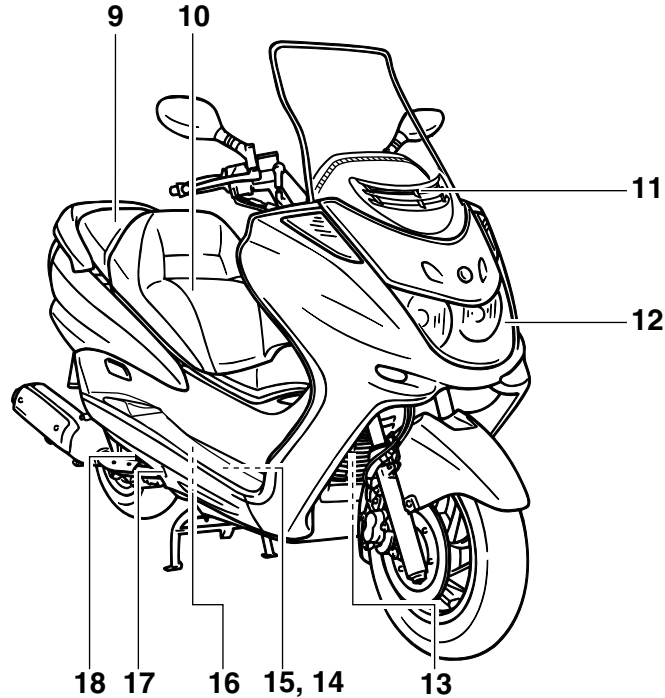

- 9. Passenger seat
- 10. Rider seat
- 11. Air flow louver
- 12. Headlight
- 13. Radiator

- 18
 - 17
 - 16
 - 15, 14
- (page 3-17)
(page 6-23)
(page 6-37)

- 14. Battery
- 15. Fuse box
- 16. Coolant reservoir cap
- 17. Coolant level check window
- 18. Engine oil filler cap

- (page 6-34)
- (page 6-36)
- (page 6-19)
- (page 6-19)
- (page 6-15)

DESCRIPTION

Controls and instruments

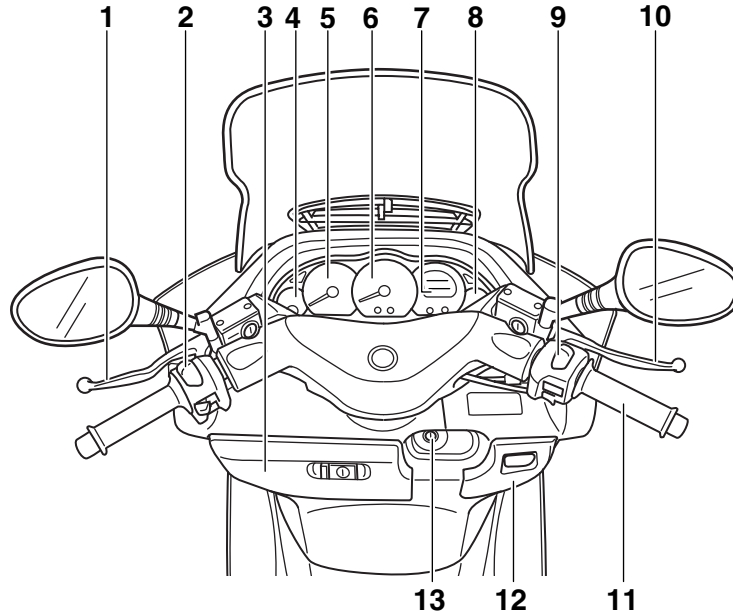

- | | | | |
|--------------------------------|-------------|---------------------------------|-------------------|
| 1. Rear brake lever | (page 3-13) | 8. Fuel gauge | (page 3-4) |
| 2. Left handlebar switches | (page 3-10) | 9. Right handlebar switches | (page 3-12) |
| 3. Front storage compartment A | (page 3-17) | 10. Front brake lever | (page 3-12) |
| 4. Coolant temperature gauge | (page 3-5) | 11. Throttle grip | (page 6-23, 6-31) |
| 5. Tachometer | (page 3-3) | 12. Front storage compartment B | (page 3-18) |
| 6. Speedometer | (page 3-3) | 13. Main switch/steering lock | (page 3-1) |
| 7. Multi-function display | (page 3-5) | | |

INSTRUMENT AND CONTROL FUNCTIONS

| | |
|---|------|
| Main switch/steering lock | 3-1 |
| Indicator lights | 3-2 |
| Speedometer | 3-3 |
| Tachometer | 3-3 |
| Fuel gauge | 3-4 |
| Coolant temperature gauge | 3-5 |
| Multi-function display | 3-5 |
| Anti-theft alarm (optional) | 3-9 |
| Handlebar switches | 3-10 |
| Front brake lever | 3-12 |
| Rear brake lever | 3-13 |
| Fuel tank cap | 3-13 |
| Fuel | 3-14 |
| Catalytic converter | 3-15 |
| Rider seat | 3-16 |
| Adjusting the rider seat | 3-17 |
| Storage compartments | 3-17 |
| Adjusting the shock absorber assemblies | 3-19 |
| Sidestand | 3-20 |
| Ignition circuit cut-off system | 3-21 |

INSTRUMENT AND CONTROL FUNCTIONS

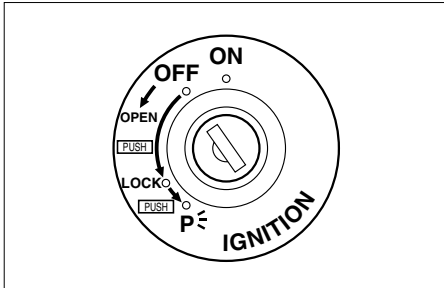

EAU00029

Main switch/steering lock

The main switch/steering lock controls the ignition and lighting systems, and is used to lock the steering. The various positions are described below.

EAU04580

ON

All electrical circuits are supplied with power, the meter lighting, taillight, license plate light and auxiliary light come on, and the engine can be started. The key cannot be removed.

NOTE:

The headlight comes on automatically when the engine is started and stays on until the key is turned to “OFF” or the sidestand is moved down.

EAU00038

OFF

All electrical systems are off. The key can be removed.

EAU00040

LOCK

The steering is locked, and all electrical systems are off. The key can be removed.

To lock the steering

1. Turn the handlebars all the way to the left.
2. Push the key in from the “OFF” position, and then turn it to “LOCK” while still pushing it.
3. Remove the key.

To unlock the steering

Push the key in, and then turn it to “OFF” while still pushing it.

EW000016

WARNING

Never turn the key to “OFF” or “LOCK” while the scooter is moving, otherwise the electrical systems will be switched off, which may result in loss of control or an accident. Make sure that the scooter is stopped before turning the key to “OFF” or “LOCK”.

INSTRUMENT AND CONTROL FUNCTIONS

EAU03733

P (Parking)

The steering is locked, and the tail-light, license light and auxiliary light are on, but all other electrical systems are off. The key can be removed.

To turn the main switch to “P”:

1. Turn the key to “LOCK”.
2. Slightly turn the key counterclockwise until it stops.
3. While still turning the key counterclockwise, push it in until it snaps into place.

ECA00043

CAUTION:

Do not use the parking position for an extended length of time, otherwise the battery may discharge.

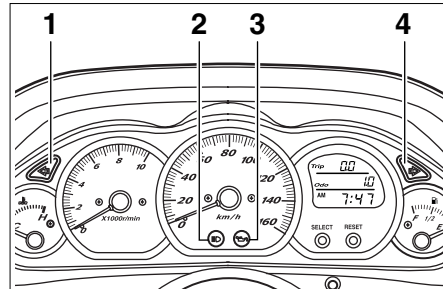

1. Left turn signal indicator light “←”
2. High beam indicator light “≡D”
3. Oil change indicator light “”
4. Right turn signal indicator light “→”

EAU00056

Indicator lights

EAU04121

Turn signal indicator lights “←” and “→”

The corresponding indicator light flashes when the turn signal switch is pushed to the left or right.

EAU00063

High beam indicator light “≡D”

This indicator light comes on when the high beam of the headlight is switched on.

EAU03734

Oil change indicator light “”

This indicator light comes on at the initial 1,000 km and every 3,000 km thereafter to indicate that the engine oil should be changed.

If the engine oil is changed before the oil change indicator comes on (i.e. before the periodic oil change interval has been reached), the indicator light must be reset after the oil change for the next periodic oil change to be indicated at the correct time. (See page 6-17 for the resetting procedure.)

The electrical circuit of the indicator light can be checked according to the following procedure.

1. Set the engine stop switch to “” and turn the key to “ON”.
2. Check that the indicator comes on for a few seconds and then goes off.
3. If the indicator light does not come on, have a Yamaha dealer check the electrical circuit.

INSTRUMENT AND CONTROL FUNCTIONS

NOTE:

The oil change indicator light may flash when the engine is revved with the scooter on the centerstand, but this does not indicate a malfunction.

3

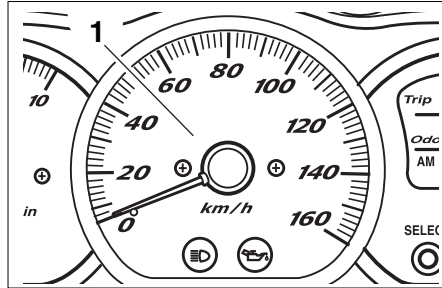

1. Speedometer

EAU04581

Speedometer

The speedometer shows the riding speed.

When the key is turned to “ON”, the speedometer needle will move to 160 km/h and back to zero in order to test the electrical circuit.

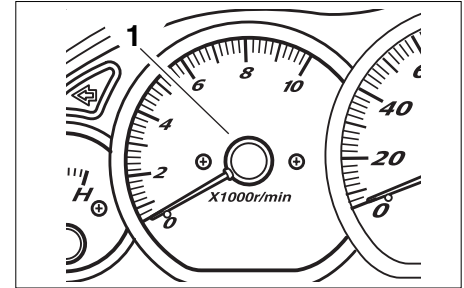

1. Tachometer

EAU04582

Tachometer

The electric tachometer allows the rider to monitor the engine speed and keep it within the ideal power range.

When the key is turned to “ON”, the tachometer needle will move to the 10,000 r/min and back to zero r/min in order to test the electrical circuit.

INSTRUMENT AND CONTROL FUNCTIONS

ECA00134

CAUTION:

- Do not operate the engine above 8,500 r/min.
- This scooter is equipped with an engine speed limiter, which prevents the engine speed from exceeding approximately 9,000 r/min.

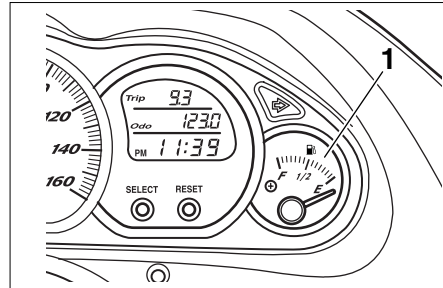

1. Fuel gauge

EAU00110

Fuel gauge

The fuel gauge indicates the amount of fuel in the fuel tank. The needle moves towards “E” (Empty) as the fuel level decreases. When the needle reaches “E”, approximately 2 L of fuel remain in the fuel tank. If this occurs, refuel as soon as possible.

NOTE:

Do not allow the fuel tank to empty itself completely.

INSTRUMENT AND CONTROL FUNCTIONS

3

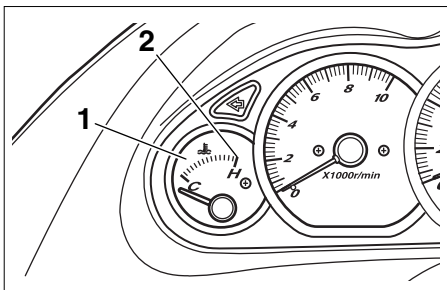

1. Coolant temperature gauge
2. Red mark

EAU03124

Coolant temperature gauge

This gauge indicates the coolant temperature when the main switch is on. The engine operating temperature will vary with changes in weather and engine load. If the needle points to the red mark, stop your scooter and let the engine cool. (See page 6-19 for details.)

EC000002

CAUTION:

Do not operate the engine if it is overheated.

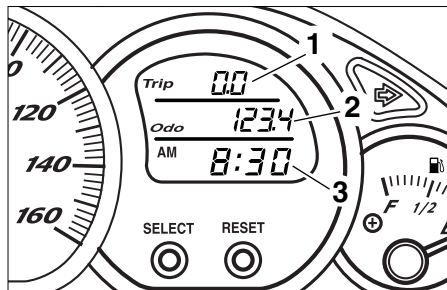

1. Tripmeter
2. Odometer, fuel tripmeter
3. Clock, outside temperature and voltage meter display

EAU04589

Multi-function display

The multi-function display is equipped with the following:

- a tripmeter (which shows the distance traveled since it was last set to zero)
- a fuel tripmeter (which shows the distance traveled when the fuel level reaches approximately 2.0 L)
- an odometer (which shows the total distance traveled)
- a clock
- an outside temperature display

- a voltage display (which shows the battery voltage)

NOTE:

- When the key is turned to “ON”, all segments of the display come on for a few seconds. During this time, the multi-function display is performing a self-test.
- Be sure to turn the key to “ON” before using the “SELECT” and “RESET” buttons.

INSTRUMENT AND CONTROL FUNCTIONS

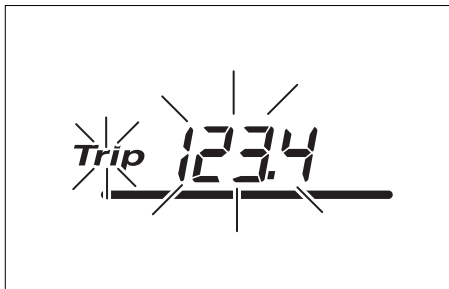

Tripmeter "Trip"

To reset the tripmeter:

1. Push the "SELECT" button until the voltage display appears, then push the "SELECT" button one more time and "Trip" starts flashing.
2. Push the "RESET" button for at least one second to reset the tripmeter to zero.

NOTE: _____

- The tripmeter reset mode automatically cancels after five seconds. To return to the reset mode, push the "SELECT" button again until "Trip" begins flashing.
- To cancel the tripmeter reset mode, push the "SELECT" button.
- If the tripmeter indicates "-----", have a Yamaha dealer check or repair the multi-function display as it may be faulty.

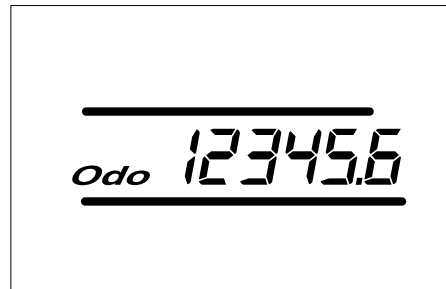

Odometer "Odo"

The odometer has two functions.

- It shows the total distance traveled.
- It automatically changes to the fuel tripmeter mode "Trip F" when the fuel level reaches approximately 2.0 L. (See "Fuel tripmeter" for details.)

NOTE: _____

If the odometer indicates "-----", have a Yamaha dealer check or repair the multi-function display as it may be faulty.

INSTRUMENT AND CONTROL FUNCTIONS



The image shows a digital display with two horizontal bars above and below the text. The text reads "Trip F" on the left and "1.2" on the right.



The image shows a digital display with two horizontal bars above and below the text. The text reads "Trip" on the left and "Odo 12345.6" on the right.



The image shows a digital display with two horizontal bars above and below the text. The text reads "AM" on the left and "12:34" on the right.

Fuel tripmeter "Trip F"

When the fuel level reaches approximately 2.0 L, the odometer display automatically changes to the fuel tripmeter mode "Trip F" and starts counting the distance traveled from that point. After refueling and traveling 5 km, the odometer display returns to "Odo".

To return to the odometer mode before refueling, push the "SELECT" button until "Trip F" begins flashing ("Trip F" will only flash for five seconds). While "Trip F" is flashing, push the "RESET" button for at least one second and the display will return to the odometer mode. From that time, both "Trip" and "Odo" are displayed until you refuel and travel 5 km.

NOTE:

The display cannot be changed back to "Trip F" after pushing the "RESET" button.

Clock

To set the clock

1. Push the "SELECT" button until the clock is displayed.
2. Push the "SELECT" button and "RESET" button together for at least two seconds.

INSTRUMENT AND CONTROL FUNCTIONS

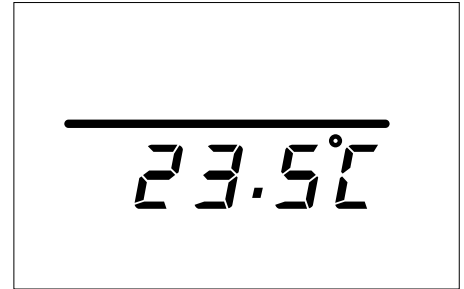
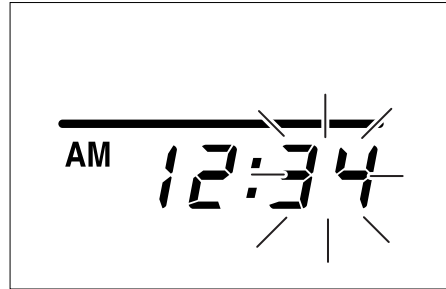
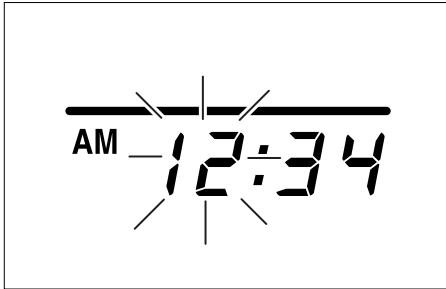

3. When the hour digits start flashing, push the “RESET” button to set the hours.

4. Push the “SELECT” button, and the minute digits will start flashing.
5. Push the “RESET” button to set the minutes.
6. Push the “SELECT” button and then release it to start the clock.

Outside temperature display

This display shows the outside temperature from $-10.0\text{ }^{\circ}\text{C}$ to $50.0\text{ }^{\circ}\text{C}$ in 0.5 ° increments.

INSTRUMENT AND CONTROL FUNCTIONS

- When the outside temperature falls below $-10.0\text{ }^{\circ}\text{C}$, “-- °C” is displayed.
- When the outside temperature climbs above $50.0\text{ }^{\circ}\text{C}$, “50.0” flashes.

NOTE:

- If “-- °C” is displayed or “50.0” flashes while the outside temperature is between $-10.0\text{ }^{\circ}\text{C}$ and $50.0\text{ }^{\circ}\text{C}$, there is a problem with the electrical circuit. Have a Yamaha dealer check or repair the electric circuit.
- The accuracy of the temperature reading may be affected when riding slowly (approximately under 20 km/h) or when stopped at traffic signals, railroad crossings, etc.

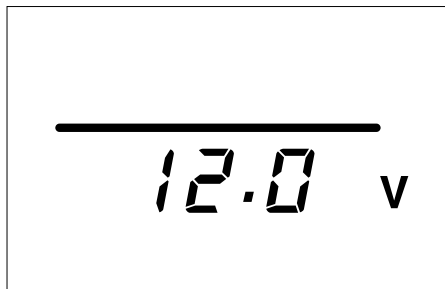

Voltage display

This display shows the battery voltage.

ECA00135

CAUTION:

If the voltage display indicates “LO” or “HI”, there may be trouble with the battery charging circuit or the battery may be faulty. If “LO” or “HI” appears in the display, have a Yamaha dealer check or repair the scooter.

EAU00109

Anti-theft alarm (optional)

This scooter can be equipped with an optional anti-theft alarm by a Yamaha dealer. Contact a Yamaha dealer for more information.

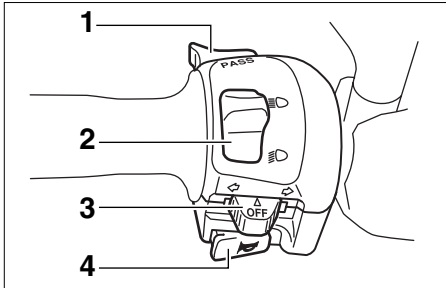

1. Pass switch "PASS"
2. Dimmer switch "H/L"
3. Turn signal switch "←/→"
4. Horn switch "📢"

EAU00118

Handlebar switches

EAU00120

Pass switch "PASS"

Press this switch to flash the headlight.

EAU03888

Dimmer switch "H/L"

Set this switch to "H" for the high beam and to "L" for the low beam.

EAU03889

Turn signal switch "←/→"

To signal a right-hand turn, push this switch to "→". To signal a left-hand turn, push this switch to "←". When released, the switch returns to the center position. To cancel the turn signal lights, push the switch in after it has returned to the center position.

EAU00129

Horn switch "📢"

Press this switch to sound the horn.

INSTRUMENT AND CONTROL FUNCTIONS

EAU00136





















Headlight variations

 : High beam light on

 : Low beam light on

 : Auxiliary light on

 : Light off



| | | Left | Right | Aux | Bulb to be used | | Destination | |
|---|---|---|---|---|-----------------|---|--|---|
| 1 |  |  |  |  | Halogen bulb |  |  | Germany, Belgium, Switzerland, Spain France, Greece, Italy, Netherlands, Norway, Portugal, Sweden |
| |  |  |  |  | | | | |
| 2 |  |  |  |  | Halogen bulb |  |  | England |
| |  |  |  |  | | | | |

NOTE:

Right and left are defined as seen when standing in front of the scooter.

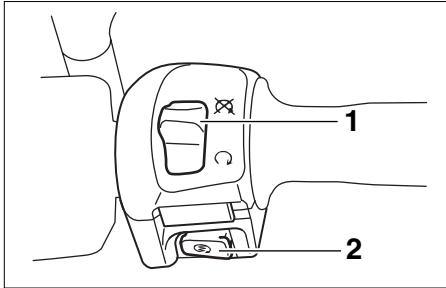

INSTRUMENT AND CONTROL FUNCTIONS



1. Engine stop switch “”
2. Start switch “”

EAU03890

Engine stop switch “”

Set this switch to “” before starting the engine. Set this switch to “” to stop the engine in case of an emergency, such as when the scooter overturns or when the throttle cable is stuck.

EAU03801

Start switch “”

With the sidestand up, push this switch while applying the front or rear brake to crank the engine with the starter.

EC000005

CAUTION:

See page 5-1 for starting instructions prior to starting the engine.

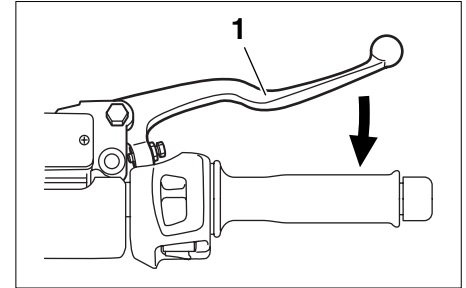

1. Front brake lever

EAU03882

Front brake lever

The front brake lever is located on the right handlebar grip. To apply the front brake, pull this lever toward the handlebar grip.

INSTRUMENT AND CONTROL FUNCTIONS

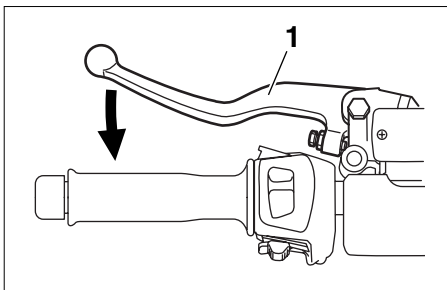

1. Rear brake lever

EAU00163

Rear brake lever

The rear brake lever is located on the left handlebar grip. To apply the rear brake, pull this lever toward the handlebar grip.

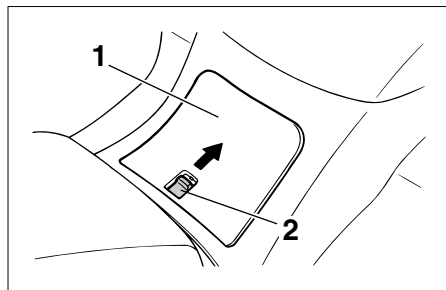

1. Lid
2. Lever

EAU03090

Fuel tank cap

To open the fuel tank cap

1. Open the lid by sliding the lever forward, and then pull the lever up.

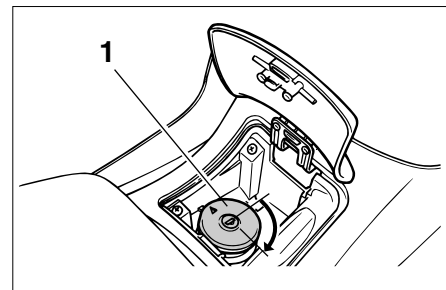

1. Fuel tank cap

2. Insert the key into the lock and turn it clockwise. The lock will be released and the fuel tank cap can be removed.

INSTRUMENT AND CONTROL FUNCTIONS

EAU00185

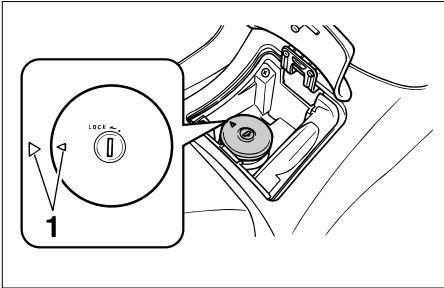

1. Match marks

To install the fuel tank cap

1. Align the match marks, insert the fuel tank cap into the tank opening, and then push down on the cap.
2. Turn the key counterclockwise to the original position, and then remove it.
3. Close the lid.

EWA00028

⚠ WARNING

Be sure that the fuel tank cap is properly installed and locked before riding the scooter.

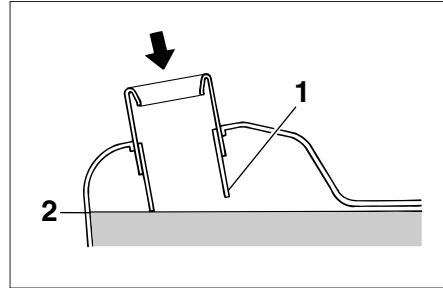

1. Filler tube
2. Fuel level

EAU03753

Fuel

Make sure that there is sufficient fuel in the tank. Fill the fuel tank to the bottom of the filler tube as shown.

EW000130

⚠ WARNING

- Do not overfill the fuel tank, otherwise it may overflow when the fuel warms up and expands.
- Avoid spilling fuel on the hot engine.

CAUTION:

Immediately wipe off spilled fuel with a clean, dry, soft cloth, since fuel may deteriorate painted surfaces or plastic parts.

INSTRUMENT AND CONTROL FUNCTIONS

EAU04284

Recommended fuel:
REGULAR UNLEADED
GASOLINE ONLY
Fuel tank capacity:
Total amount:
12 L

ECA00104

CAUTION:

Use only unleaded gasoline. The use of leaded gasoline will cause severe damage to internal engine parts, such as the valves and piston rings, as well as to the exhaust system.

Your Yamaha engine has been designed to use regular unleaded gasoline with a research octane number of 91 or higher. If knocking (or pinging) occurs, use a gasoline of a different brand or premium unleaded fuel. Use of unleaded fuel will extend spark plug life and reduce maintenance costs.

EAU03098

Catalytic converter

This scooter is equipped with a catalytic converter in the muffler.

EW000128

⚠ WARNING

The exhaust system is hot after operation. Make sure that the exhaust system has cooled down before doing any maintenance work.

INSTRUMENT AND CONTROL FUNCTIONS

CAUTION:

EC000114

The following precautions must be observed to prevent a fire hazard or other damages.

- Use only unleaded gasoline. The use of leaded gasoline will cause unreparable damage to the catalytic converter.
- Never park the scooter near possible fire hazards such as grass or other materials that easily burn.
- Do not allow the engine to idle too long.

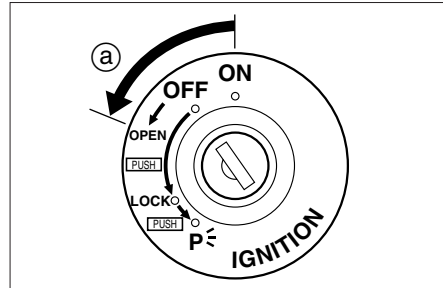

a. Open.

EAU03091

Rider seat

To open the rider seat

1. Place the scooter on the center-stand.
2. Insert the key into the main switch, and then turn it counter-clockwise.

NOTE:

Do not push inward when turning the key.

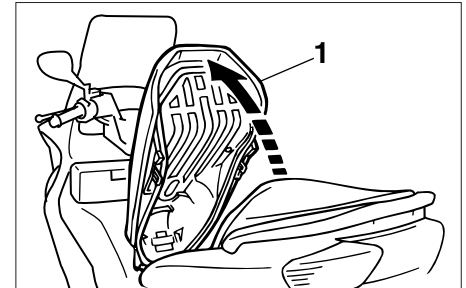

1. Rider seat

3. Fold the rider seat up.

To close the rider seat

1. Fold the rider seat down, and then push it down to lock it in place.
2. Remove the key from the main switch if the scooter will be left unattended.

NOTE:

Make sure that the seat is properly secured before riding.

INSTRUMENT AND CONTROL FUNCTIONS

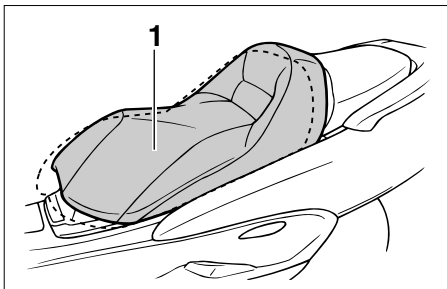

1. Rider seat

EAU03096*

Adjusting the rider seat

The rider seat can be adjusted as follows to change the riding position.

1. Open the rider seat.

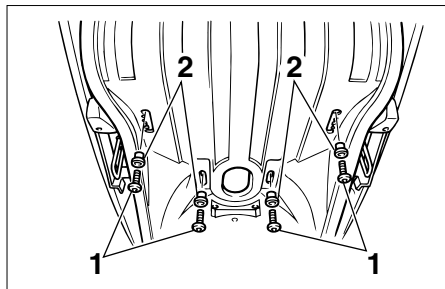

1. Bolt (×4)
2. Collar (×4)

2. Remove the bolts and collars.
3. Slide the rider seat forward or backward to the desired position.
4. Install the collars and securely tighten the bolts.
5. Close the rider seat.

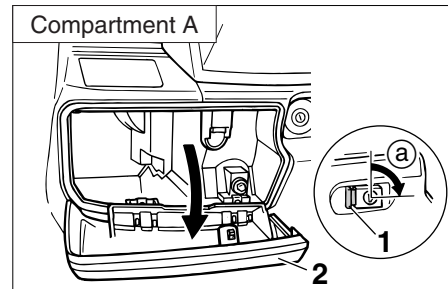

1. Button
2. Lid
- a. Lock.

EAU03331

Storage compartments

Front storage compartment A

To open the storage compartment when it is locked, insert the key in the lock, turn it counterclockwise, and then grasp the lock while pushing the button in.

To open the storage compartment when it is unlocked, simply grasp the lock while pushing the button in.

INSTRUMENT AND CONTROL FUNCTIONS

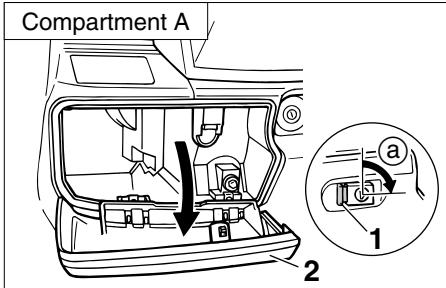

1. Button
2. Lid
- a. Lock.

To lock the storage compartment, push the lid into the original position, insert the key in the lock, turn it clockwise, and then remove it.

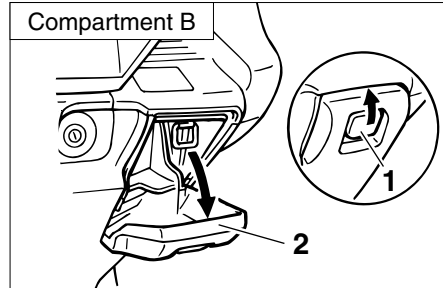

1. Lever
2. Lid

Front storage compartment B

To open the storage compartment, slide the lever up, and then pull on the lever.

To close the storage compartment, push the lid into the original position.

EWA00034

⚠ WARNING

Do not store heavy items in this compartment.

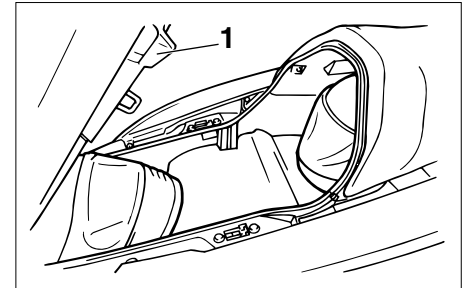

1. Rider seat

Rear storage compartment

Two helmets can be stored in the storage compartment under the seats. (See page 3-16 for rider seat opening and closing procedures.)

INSTRUMENT AND CONTROL FUNCTIONS

CAUTION: _____

ECA00051

Do not leave the rider seat open for an extended period of time, otherwise the light may cause the battery to discharge.

⚠️ WARNING _____

EWA00035

Do not exceed the following loading limits:

- Front storage compartment A: 2 kg
- Rear storage compartment: 5 kg
- Maximum load for the vehicle: 185 kg

Adjusting the shock absorber assemblies

EAU04552

Each shock absorber assembly is equipped with a spring preload adjusting ring.

CAUTION: _____

EC000015

Never attempt to turn an adjusting mechanism beyond the maximum or minimum settings.

⚠️ WARNING _____

EW000040

Always adjust both shock absorber assemblies equally, otherwise poor handling and loss of stability may result.

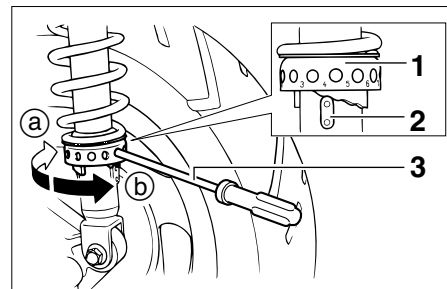

1. Spring preload adjusting ring
2. Position indicator
3. Spring preload adjusting tool

Adjust the spring preload as follows. To increase the spring preload and thereby harden the suspension, turn the adjusting ring on each shock absorber assembly in direction (a). To decrease the spring preload and thereby soften the suspension, turn the adjusting ring on each shock absorber assembly in direction (b).

INSTRUMENT AND CONTROL FUNCTIONS

EW000044

NOTE:

- Align the appropriate notch in the adjusting ring with the position indicator on the shock absorber.
- Use the spring preload adjusting tool included in the owner's tool kit to make this adjustment.

| | Setting |
|----------------|---------|
| Minimum (soft) | 1 |
| Standard | 4 |
| Maximum (hard) | 7 |

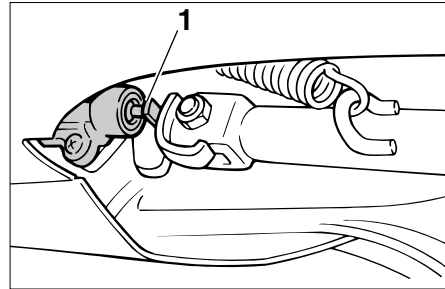

1. Sidestand switch

EAU00330

Sidestand

The sidestand is located on the left side of the frame. Raise the sidestand or lower it with your foot while holding the scooter upright.

NOTE:

The built-in sidestand switch is part of the ignition circuit cut-off system, which cuts the ignition in certain situations. (See further down for an explanation of the ignition circuit cut-off system.)

⚠ WARNING

The scooter must not be ridden with the sidestand down, or if the sidestand cannot be properly moved up (or does not stay up), otherwise the sidestand could contact the ground and distract the operator, resulting in a possible loss of control. Yamaha's ignition circuit cut-off system has been designed to assist the operator in fulfilling the responsibility of raising the sidestand before starting off. Therefore, check this system regularly as described below and have a Yamaha dealer repair it if it does not function properly.

INSTRUMENT AND CONTROL FUNCTIONS

EAU00337

Ignition circuit cut-off system

The ignition circuit cut-off system (comprising the sidestand switch and brake light switches) has the following functions.

- It prevents starting when the sidestand is up, but neither brake is applied.
- It prevents starting when either brake is applied, but the sidestand is still down.
- It cuts the running engine when the sidestand is moved down.

Periodically check the operation of the ignition circuit cut-off system according to the following procedure.

EW000045

⚠ WARNING

If a malfunction is noted, have a Yamaha dealer check the system before riding.

INSTRUMENT AND CONTROL FUNCTIONS

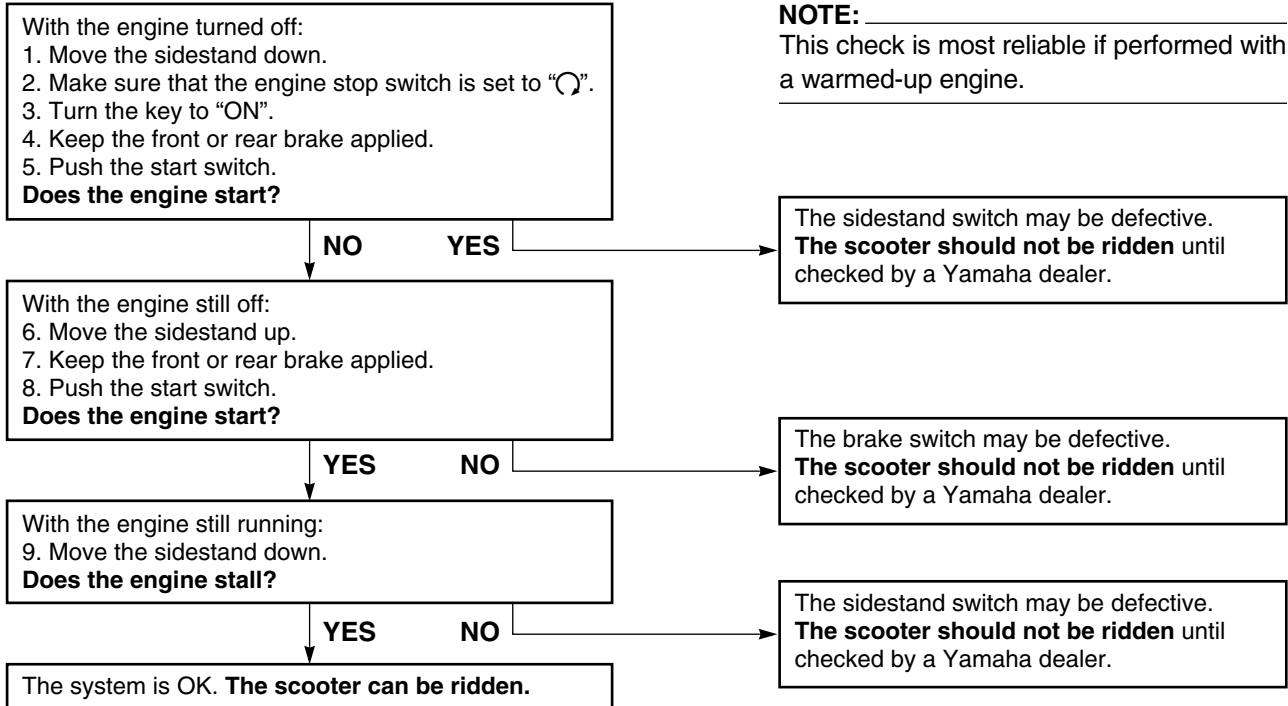

Pre-operation check list4-1

PRE-OPERATION CHECKS

The condition of a vehicle is the owner's responsibility. Vital components can start to deteriorate quickly and unexpectedly, even if the vehicle remains unused (for example, as a result of exposure to the elements). Any damage, fluid leakage or loss of tire air pressure could have serious consequences. Therefore, it is very important, in addition to a thorough visual inspection, to check the following points before each ride.

EAU03439

Pre-operation check list

| ITEM | CHECKS | PAGE |
|-------------------------------|--|-----------------|
| Fuel | <ul style="list-style-type: none"> • Check fuel level in fuel tank. • Refuel if necessary. • Check fuel line for leakage. | 3-4, 3-14–3-15 |
| Engine oil | <ul style="list-style-type: none"> • Check oil level in engine. • If necessary, add recommended oil to specified level. • Check vehicle for oil leakage. | 6-14–6-17 |
| Final transmission oil | <ul style="list-style-type: none"> • Check vehicle for oil leakage. | 6-18–6-19 |
| Coolant | <ul style="list-style-type: none"> • Check coolant level in reservoir. • If necessary, add recommended coolant to specified level. • Check cooling system for leakage. | 3-5, 6-19–6-20 |
| Front brake | <ul style="list-style-type: none"> • Check operation. • If soft or spongy, have Yamaha dealer bleed hydraulic system. • Check lever free play. • Adjust if necessary. • Check fluid level in reservoir. • If necessary, add recommended brake fluid to specified level. • Check hydraulic system for leakage. | 3-12, 6-27–6-30 |

PRE-OPERATION CHECKS

| ITEM | CHECKS | PAGE |
|--|--|-----------------------|
| Rear brake | <ul style="list-style-type: none"> • Check operation. • If soft or spongy, have Yamaha dealer bleed hydraulic system. • Check fluid level in reservoir. • If necessary, add recommended brake fluid to specified level. • Check hydraulic system for leakage. | 3-13, 6-27–6-30 |
| Throttle grip | <ul style="list-style-type: none"> • Make sure that operation is smooth. • Check cable free play. • If necessary, have Yamaha dealer adjust cable free play and lubricate cable and grip housing. | 6-23, 6-31 |
| Wheels and tires | <ul style="list-style-type: none"> • Check for damage. • Check tire condition and tread depth. • Check air pressure. • Correct if necessary. | 6-24–6-27 |
| Brake levers | <ul style="list-style-type: none"> • Make sure that operation is smooth. • Lubricate lever pivoting points if necessary. | 3-12–3-13, 6-27, 6-31 |
| Centerstand, sidestand | <ul style="list-style-type: none"> • Make sure that operation is smooth. • Lubricate pivots if necessary. | 6-31–6-32 |
| Chassis fasteners | <ul style="list-style-type: none"> • Make sure that all nuts, bolts and screws are properly tightened. • Tighten if necessary. | — |
| Instruments, lights, signals and switches | <ul style="list-style-type: none"> • Check operation. • Correct if necessary. | 3-2–3-12, 6-37–6-42 |
| Sidestand switch | <ul style="list-style-type: none"> • Check operation of ignition circuit cut-off system. • If system is defective, have Yamaha dealer check vehicle. | 3-20–3-22 |

PRE-OPERATION CHECKS

NOTE:

Pre-operation checks should be made each time the scooter is used. Such an inspection can be accomplished in a very short time; and the added safety it assures is more than worth the time involved.

EWA00033

⚠ WARNING

If any item in the Pre-operation check list is not working properly, have it inspected and repaired before operating the scooter.

OPERATION AND IMPORTANT RIDING POINTS

| | |
|--|-----|
| Starting the engine | 5-1 |
| Starting off | 5-2 |
| Acceleration and deceleration | 5-3 |
| Braking | 5-3 |
| Tips for reducing fuel consumption | 5-4 |
| Engine break-in | 5-4 |
| Parking | 5-5 |

OPERATION AND IMPORTANT RIDING POINTS

⚠️ WARNING

EAU01118

- Become thoroughly familiar with all operating controls and their functions before riding. Consult a Yamaha dealer regarding any control or function that you do not thoroughly understand.
- Never start the engine or operate it in a closed area for any length of time. Exhaust fumes are poisonous, and inhaling them can cause loss of consciousness and death within a short time. Always make sure that there is adequate ventilation.
- For safety, always start the engine with the centerstand down.

Starting the engine

EAU03843

CAUTION:

EC000046

See page 5-4 for engine break-in instructions prior to operating the vehicle for the first time.

In order for the ignition circuit cut-off system to enable starting, the side-stand must be up.

⚠️ WARNING

EW000054

- Before starting the engine, check the function of the ignition circuit cut-off system according to the procedure described on page 3-22.
- Never ride with the sidestand down.

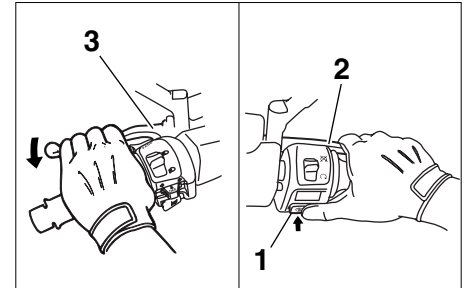

1. Start switch
2. Front brake lever
3. Rear brake lever

1. Turn the key to "ON" and make sure that the engine stop switch is set to "O".
2. Close the throttle completely.
3. Start the engine by pushing the start switch while applying the front or rear brake.

OPERATION AND IMPORTANT RIDING POINTS

NOTE:

If the engine does not start, release the start switch, wait a few seconds, and then try again. Each starting attempt should be as short as possible to preserve the battery. Do not crank the engine more than 10 seconds on any one attempt. If the engine does not start, try with the throttle open 1/8 turn.

ECA00045

CAUTION:

For maximum engine life, never accelerate hard when the engine is cold!

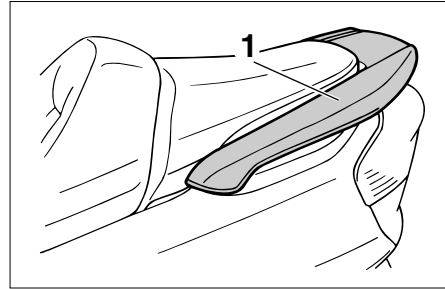

1. Grab bar

EAU00433

Starting off

NOTE:

Before starting off, allow the engine to warm up.

1. While pulling the rear brake lever with your left hand and holding the grab bar with your right hand, push the scooter off the center-stand.
2. Sit astride the seat, and then adjust the rear view mirrors.
3. Switch the turn signal on.

4. Check for oncoming traffic, and then slowly turn the throttle grip (on the right) in order to take off.
5. Switch the turn signal off.

OPERATION AND IMPORTANT RIDING POINTS

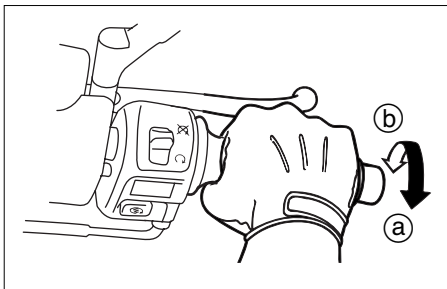

EAU00434

5 Acceleration and deceleration

The speed can be adjusted by opening and closing the throttle. To increase the speed, turn the throttle grip in direction ①. To reduce the speed, turn the throttle grip in direction ②.

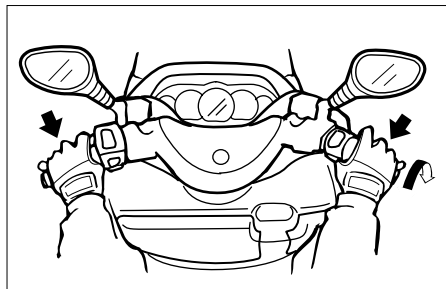

EAU00435

Braking

1. Close the throttle completely.
2. Apply both front and rear brakes simultaneously while gradually increasing the pressure.

EW000057

⚠ WARNING

- Avoid braking hard or suddenly (especially when leaning over to one side), otherwise the scooter may skid or overturn.
- Railroad crossings, streetcar rails, iron plates on road construction sites, and manhole covers become extremely slippery when wet. Therefore, slow down when approaching such areas and cross them with caution.
- Keep in mind that braking on a wet road is much more difficult.
- Ride slowly down a hill, as braking downhill can be very difficult.

Tips for reducing fuel consumption

EAU03093

Fuel consumption depends largely on your riding style. Consider the following tips to reduce fuel consumption:

- Thoroughly warm up the engine.
- Avoid high engine speeds during acceleration.
- Avoid high engine speeds with no load on the engine.
- Turn the engine off instead of letting it idle for an extended length of time (e.g., in traffic jams, at traffic lights or at railroad crossings).

Engine break-in

EAU01128

There is never a more important period in the life of your engine than the period between 0 and 1,600 km. For this reason, you should read the following material carefully.

Since the engine is brand new, do not put an excessive load on it for the first 1,600 km. The various parts in the engine wear and polish themselves to the correct operating clearances. During this period, prolonged full-throttle operation or any condition that might result in engine overheating must be avoided.

EAU04590

0–1,000 km

Avoid prolonged operation above 4,000 r/min.

1,000–1,600 km

Avoid prolonged operation above 5,000 r/min.

ECA00138

CAUTION: _____

After 1,000 km of operation, be sure to replace the engine oil and final transmission oil.

1,600 km and beyond

The vehicle can now be operated normally.

ECA00137

CAUTION: _____

- Keep the engine speed below 8,500 r/min.
- If any engine trouble should occur during the engine break-in period, immediately have a Yamaha dealer check the vehicle.

OPERATION AND IMPORTANT RIDING POINTS

EAU00461

Parking

When parking, stop the engine, and then remove the key from the main switch.

EW000058

⚠ WARNING

- Since the engine and exhaust system can become very hot, park in a place where pedestrians or children are not likely to touch them.
- Do not park on a slope or on soft ground, otherwise the scooter may overturn.

EC000062

CAUTION:

Never park in an area where there are fire hazards such as grass or other flammable materials.

PERIODIC MAINTENANCE AND MINOR REPAIR

| | | | |
|---|------|--|------|
| Owner's tool kit | 6-1 | Checking the front fork | 6-32 |
| Periodic maintenance and lubrication chart | 6-3 | Checking the steering | 6-33 |
| Removing and installing the cowlings and panel ... | 6-6 | Checking the wheel bearings | 6-33 |
| Checking the spark plug | 6-12 | Removing the battery cover | 6-34 |
| Engine oil | 6-14 | Battery | 6-34 |
| Final transmission oil | 6-18 | Replacing the fuses | 6-36 |
| Coolant | 6-19 | Replacing a headlight bulb | 6-37 |
| Air filter and V-belt case air filter elements | 6-21 | Replacing a front turn signal light bulb | 6-39 |
| Air flow louver | 6-23 | Replacing a rear turn signal light bulb | 6-40 |
| Adjusting the throttle cable free play | 6-23 | Replacing a tail/brake light bulb | 6-40 |
| Adjusting the valve clearance | 6-23 | Replacing the license plate light bulb | 6-41 |
| Tires | 6-24 | Troubleshooting | 6-42 |
| Cast wheels | 6-26 | Troubleshooting charts | 6-43 |
| Adjusting the front and rear brake lever free play | 6-27 | | |
| Checking the front and rear brake pads | 6-28 | | |
| Checking the brake fluid level | 6-29 | | |
| Changing the brake fluid | 6-30 | | |
| Checking and lubricating the cables | 6-30 | | |
| Checking and lubricating the throttle grip and cable | 6-31 | | |
| Lubricating the front and rear brake levers | 6-31 | | |
| Checking and lubricating the centerstand and sidestand | 6-31 | | |

PERIODIC MAINTENANCE AND MINOR REPAIR

EAU00464

Safety is an obligation of the owner. Periodic inspection, adjustment and lubrication will keep your vehicle in the safest and most efficient condition possible. The most important points of inspection, adjustment, and lubrication are explained on the following pages.

The intervals given in the periodic maintenance and lubrication chart should be simply considered as a general guide under normal riding conditions. However, **DEPENDING ON THE WEATHER, TERRAIN, GEOGRAPHICAL LOCATION, AND INDIVIDUAL USE, THE MAINTENANCE INTERVALS MAY NEED TO BE SHORTENED.**

EW00060

⚠ WARNING

If you are not familiar with scooter maintenance work, have a Yamaha dealer do it for you.

EAU00466

⚠ WARNING

This scooter is designed for use on paved roads only. If this scooter is operated in abnormally dusty, muddy or wet conditions, the air filter element should be cleaned or replaced more frequently, otherwise rapid engine wear may result. Consult a Yamaha dealer for proper maintenance intervals.

EAU03623

Owner's tool kit

The owner's tool kit is located inside the rear storage compartment. (See page 3-18 for the rear storage compartment opening procedures.)

PERIODIC MAINTENANCE AND MINOR REPAIR

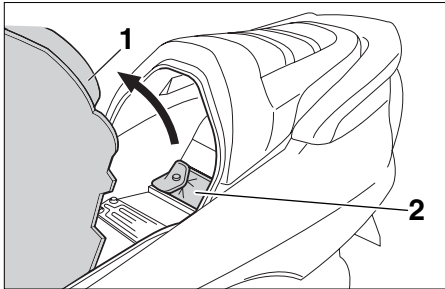

1. Mat
2. Owner's tool kit

Pull up the mat, and then remove the owner's tool kit.

The service information included in this manual and the tools provided in the owner's tool kit are intended to assist you in the performance of preventive maintenance and minor repairs. However, additional tools such as a torque wrench may be necessary to perform certain maintenance work correctly.

NOTE: _____

If you do not have the tools or experience required for a particular job, have a Yamaha dealer perform it for you.

EW000063

⚠WARNING _____

Modifications not approved by Yamaha may cause loss of performance and render the vehicle unsafe for use. Consult a Yamaha dealer before attempting any changes.

PERIODIC MAINTENANCE AND MINOR REPAIR

EAU03685

Periodic maintenance and lubrication chart

NOTE:

- The annual checks must be performed every year, except if a kilometer-based maintenance is performed instead.
- From 50,000 km, repeat the maintenance intervals starting from 10,000 km.
- Items marked with an asterisk should be performed by a Yamaha dealer as they require special tools, data and technical skills.

| NO. | ITEM | CHECK OR MAINTENANCE JOB | ODOMETER READING (× 1,000 km) | | | | | ANNUAL CHECK |
|-----|--------------------------------|--|-------------------------------|----|----|----|----|--------------|
| | | | 1 | 10 | 20 | 30 | 40 | |
| 1 | * Fuel line | • Check fuel hoses and vacuum hose for cracks or damage. | | √ | √ | √ | √ | √ |
| 2 | Spark plug | • Check condition. • Clean and regap. | | √ | | √ | | |
| | | • Replace. | | | √ | | √ | |
| 3 | * Valves | • Check valve clearance. • Adjust. | | | √ | | √ | |
| 4 | Air filter element | • Clean. | | √ | | √ | | |
| | | • Replace. | | | √ | | √ | |
| 5 | V-belt case air filter element | • Clean. | | √ | √ | √ | √ | |
| 6 | * Front brake | • Check operation, fluid level and vehicle for fluid leakage. (See NOTE on page 6-5.) | √ | √ | √ | √ | √ | √ |
| | | • Replace brake pads. | Whenever worn to the limit | | | | | |
| 7 | * Rear brake | • Check operation, fluid level and vehicle for fluid leakage. (See NOTE on page 6-5.) | √ | √ | √ | √ | √ | √ |
| | | • Replace brake pads. | Whenever worn to the limit | | | | | |

PERIODIC MAINTENANCE AND MINOR REPAIR

| NO. | ITEM | CHECK OR MAINTENANCE JOB | ODOMETER READING (× 1,000 km) | | | | | ANNUAL CHECK |
|-----|-----------------------------|--|-------------------------------|---|----|----|----|--------------|
| | | | 1 | 10 | 20 | 30 | 40 | |
| 8 | * Brake hoses | • Check for cracks or damage. | | √ | √ | √ | √ | √ |
| | | • Replace. (See NOTE on page 6-5.) | Every 4 years | | | | | |
| 9 | * Wheels | • Check runout and for damage. | | √ | √ | √ | √ | |
| 10 | * Tires | <ul style="list-style-type: none"> • Check tread depth and for damage. • Replace if necessary. • Check air pressure. • Correct if necessary. | | √ | √ | √ | √ | √ |
| 11 | * Wheel bearings | • Check bearing for looseness or damage. | | √ | √ | √ | √ | |
| 12 | * Steering bearings | • Check bearing play and steering for roughness. | √ | √ | √ | √ | √ | |
| | | • Lubricate with lithium-soap-based grease. | Every 20,000 km | | | | | |
| 13 | * Chassis fasteners | • Make sure that all nuts, bolts and screws are properly tightened. | | √ | √ | √ | √ | √ |
| 14 | Sidestand, centerstand | <ul style="list-style-type: none"> • Check operation. • Lubricate. | | √ | √ | √ | √ | √ |
| 15 | * Sidestand switch | • Check operation. | √ | √ | √ | √ | √ | √ |
| 16 | * Front fork | • Check operation and for oil leakage. | | √ | √ | √ | √ | |
| 17 | * Shock absorber assemblies | • Check operation and shock absorbers for oil leakage. | | √ | √ | √ | √ | |
| 18 | * Carburetor | • Adjust engine idling speed. | √ | √ | √ | √ | √ | √ |
| 19 | Engine oil | • Change. (See page 3-2 and 6-17 for more information about the oil change indicator light.) | √ | When the oil change indicator light comes on (every 3,000 km) | | | | |
| | | • Check oil level and vehicle for oil leakage. | Every 3,000 km | | | | | √ |

PERIODIC MAINTENANCE AND MINOR REPAIR

| NO. | ITEM | CHECK OR MAINTENANCE JOB | ODOMETER READING (× 1,000 km) | | | | | ANNUAL CHECK |
|-----|-----------------------------------|---|-------------------------------|----|----|----|----|--------------|
| | | | 1 | 10 | 20 | 30 | 40 | |
| 20 | * Engine oil strainer | • Clean. | √ | | | | | |
| 21 | * Cooling system | • Check coolant level and vehicle for coolant leakage. | | √ | √ | √ | √ | √ |
| | | • Change. | Every 3 years | | | | | |
| 22 | Final transmission oil | • Check vehicle for oil leakage. | √ | √ | | √ | | |
| | | • Change. | √ | | √ | | √ | |
| 23 | * V-belt | • Replace. | Every 20,000 km | | | | | |
| 24 | * Front and rear brake switches | • Check operation. | √ | √ | √ | √ | √ | √ |
| 25 | Moving parts and cables | • Lubricate. | | √ | √ | √ | √ | √ |
| 26 | * Throttle grip housing and cable | • Check operation and free play. • Adjust the throttle cable free play if necessary. • Lubricate the throttle grip housing and cable. | | √ | √ | √ | √ | √ |
| 27 | * Lights, signals and switches | • Check operation. • Adjust headlight beam. | √ | √ | √ | √ | √ | √ |

EAU03884

NOTE:

- The air filter needs more frequent service if you are riding in unusually wet or dusty areas.
- Hydraulic brake service
 - Regularly check and, if necessary, correct the brake fluid level.
 - Every two years replace the internal components of the brake master cylinders and calipers, and change the brake fluid.
 - Replace the brake hoses every four years and if cracked or damaged.

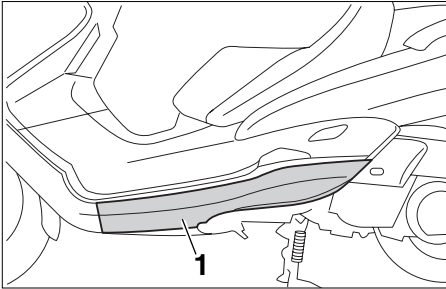

1. Cowling A

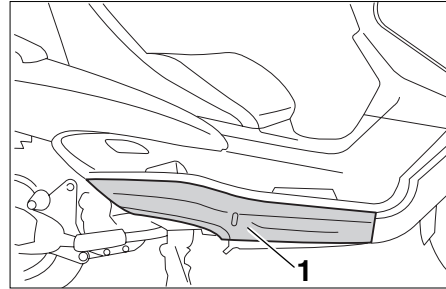

1. Cowling B

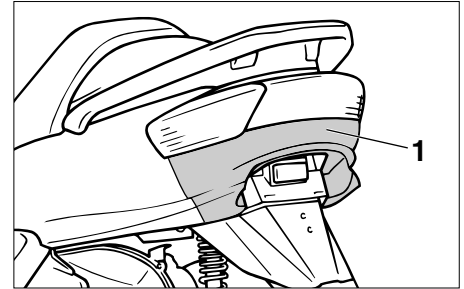

1. Cowling C

EAU03624

Removing and installing the cowlings and panel

The cowlings and panel shown above need to be removed to perform some of the maintenance jobs described in this chapter. Refer to this section each time a cowling or the panel needs to be removed and installed.

PERIODIC MAINTENANCE AND MINOR REPAIR

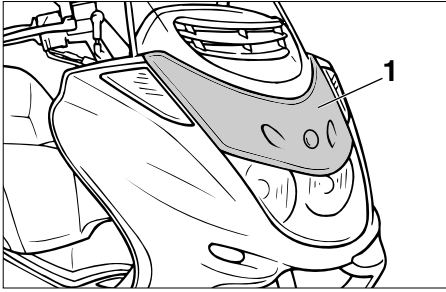

1. Panel A

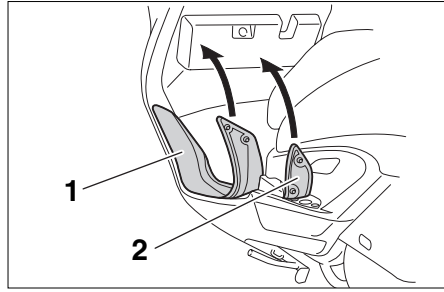

1. Mat A
2. Mat B

EAU03615

Cowling A

To remove the cowling

1. Pull up the left floorboard mats as shown.

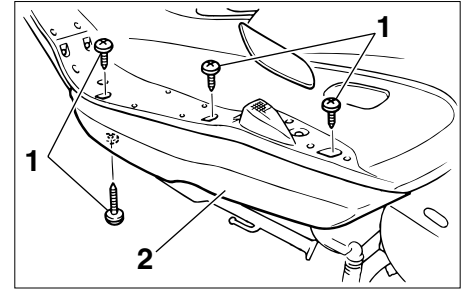

1. Screw (x4)
2. Cowling A

2. Remove the cowling screws.

PERIODIC MAINTENANCE AND MINOR REPAIR

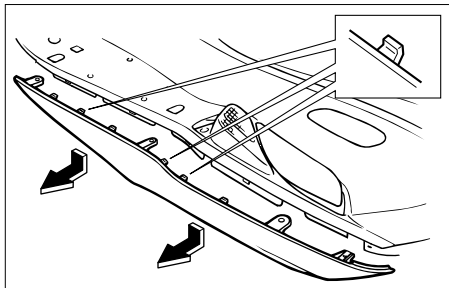

3. Pull the cowling down slightly, and then pull it outward as shown.

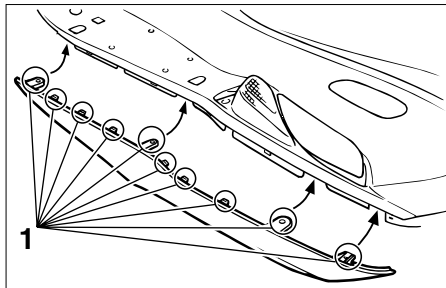

1. Tab (x10)

To install the cowling

1. Insert the tabs on the cowling into the slots as shown, and then install the screws.
2. Place the floorboard mats in the original position.

ECA00067

CAUTION: _____

Take care not to damage the tabs on the cowling when removing and or installing it.

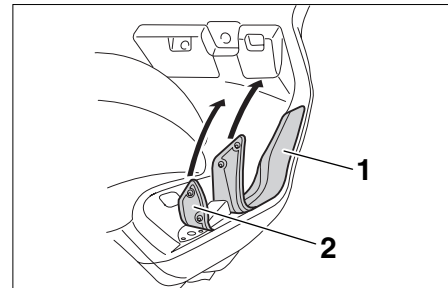

1. Mat A
2. Mat B

Cowling B

To remove the cowling

1. Pull up the right floorboard mats as shown.

EAU03632

PERIODIC MAINTENANCE AND MINOR REPAIR

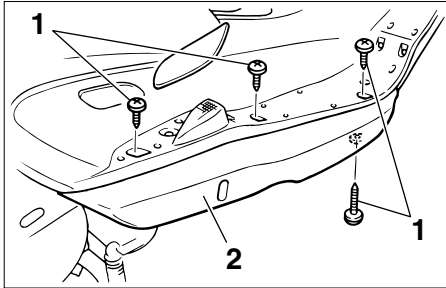

1. Screw (x4)
 2. Cowling B
2. Remove the screws.

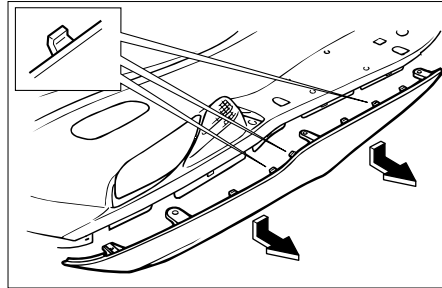

3. Pull the cowling down slightly, and then pull it outward as shown.

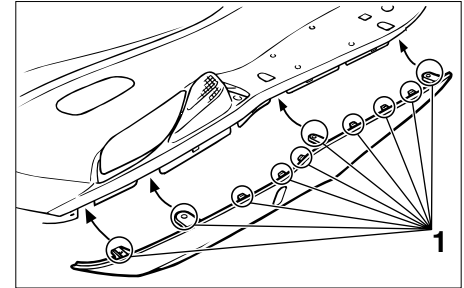

1. Tab (x10)

To install the cowling

1. Insert the tabs on the cowling into the slots as shown, and then install the screws.
2. Place the floorboard mats in the original position.

ECA00067

CAUTION: _____

Take care not to damage the tabs on the cowling when removing and or installing it.

PERIODIC MAINTENANCE AND MINOR REPAIR

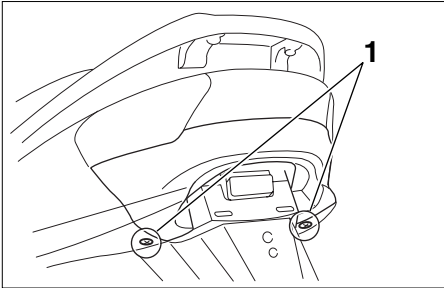

1. Screw (×2)

EAU03617

Cowling C

To remove the cowling

1. Remove the cowling screws.

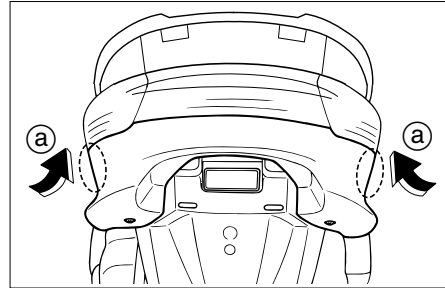

- a. Push.

2. Push the cowling in lightly, and then pull it back as shown.

ECA00067

CAUTION:

Take care not to damage the tabs on the cowling when removing and or installing it.

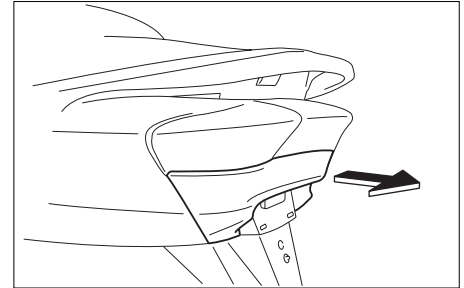

PERIODIC MAINTENANCE AND MINOR REPAIR

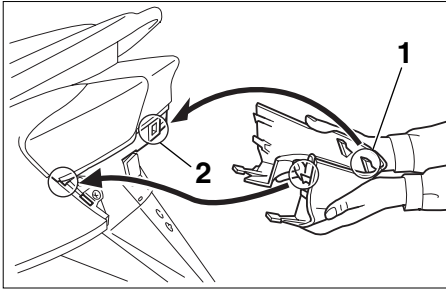

1. Tab (x4)
2. Slot (x4)

To install the cowling

1. Insert the tabs on the cowling into the slots as shown, and then push the cowling in until it snaps into place.
2. Install the cowling screws.

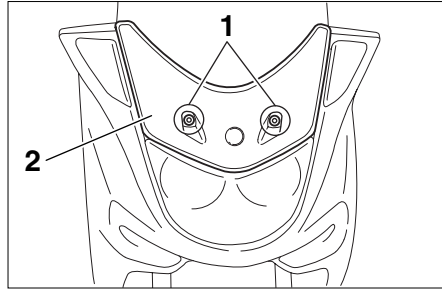

1. Bolt (x2)
2. Panel A

Panel A

To remove the panel

Remove the bolts, and then pull the panel out as shown.

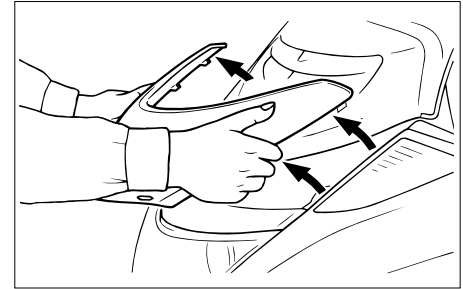

EAU03628

PERIODIC MAINTENANCE AND MINOR REPAIR

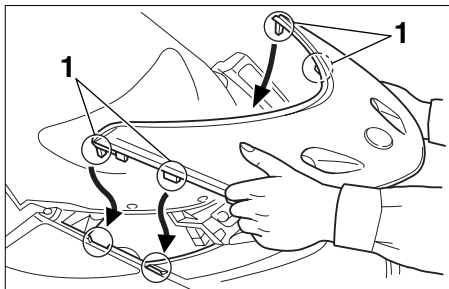

1. Tab (x4)

To install the panel

Place the panel in the original position, and then install the bolts.

EAU03620

Checking the spark plug

The spark plug is an important engine component, which is easy to check. Since heat and deposits will cause any spark plug to slowly erode, the spark plug should be removed and checked in accordance with the periodic maintenance and lubrication chart. In addition, the condition of the spark plug can reveal the condition of the engine.

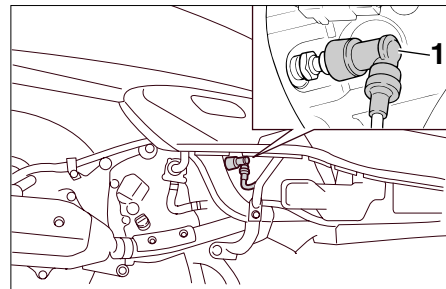

1. Spark plug cap

To remove the spark plug

1. Remove cowling B. (See page 6-8 for cowling removal and installation procedures.)
2. Remove the spark plug cap.

PERIODIC MAINTENANCE AND MINOR REPAIR

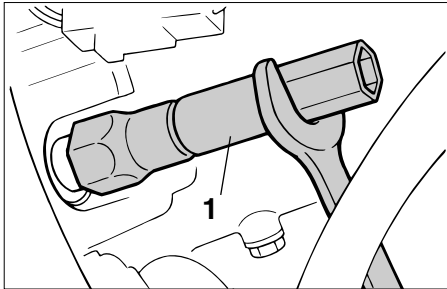

1. Spark plug wrench

3. Remove the spark plug as shown, with the spark plug wrench included in the owner's tool kit.

To check the spark plug

1. Check that the porcelain insulator around the center electrode of the spark plug is a medium-to-light tan (the ideal color when the scooter is ridden normally).

NOTE:

If the spark plug shows a distinctly different color, the engine could be defective. Do not attempt to diagnose such problems yourself. Instead, have a Yamaha dealer check the scooter.

2. Check the spark plug for electrode erosion and excessive carbon or other deposits, and replace it if necessary.

Specified spark plug:
DR8EA (NGK)

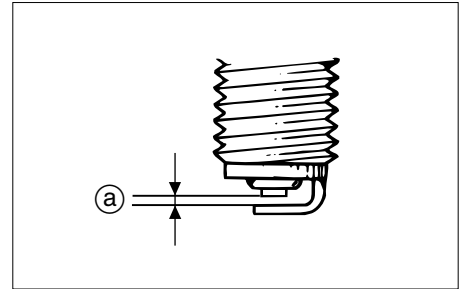

a. Spark plug gap

To install the spark plug

1. Measure the spark plug gap with a wire thickness gauge and, if necessary, adjust the gap to specification.

Spark plug gap:
0.6–0.7 mm

2. Clean the surface of the spark plug gasket and its mating surface, and then wipe off any grime from the spark plug threads.
3. Install the spark plug with the spark plug wrench, and then tighten it to the specified torque.

PERIODIC MAINTENANCE AND MINOR REPAIR

Tightening torque:
Spark plug:
17.5 Nm (1.75 m·kgf)

NOTE:

If a torque wrench is not available when installing a spark plug, a good estimate of the correct torque is 1/4–1/2 turn past finger tight. However, the spark plug should be tightened to the specified torque as soon as possible.

4. Install the spark plug cap.
5. Install the cowling.

EAU03119

Engine oil

The engine oil level should be checked before each ride. In addition, the oil must be changed at the intervals specified in the periodic maintenance and lubrication chart and when the oil change indicator light comes on.

To check the engine oil level

1. Place the scooter on the center-stand.

NOTE:

Make sure that the scooter is positioned straight up when checking the oil level. A slight tilt to the side can result in a false reading.

2. Start the engine, warm it up for several minutes, and then turn it off.

PERIODIC MAINTENANCE AND MINOR REPAIR

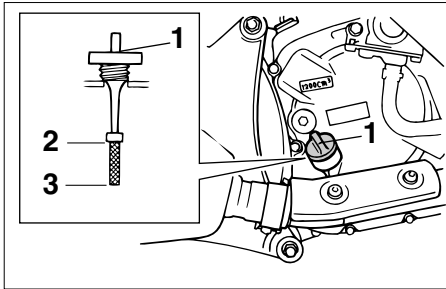

1. Engine oil filler cap
2. Maximum level mark
3. Minimum level mark

3. Wait a few minutes until the oil settles, remove the oil filler cap, wipe the dipstick clean, insert it back into the oil filler hole (without screwing it in), and then remove it again to check the oil level.

NOTE: _____

The engine oil should be between the minimum and maximum level marks.

4. If the engine oil is below the minimum level mark, add sufficient oil of the recommended type to raise it to the correct level.
5. Insert the dipstick into the oil filler hole, and then tighten the oil filler cap.

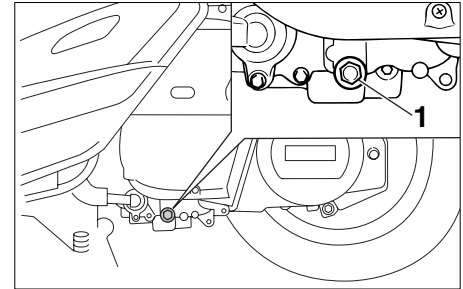

1. Engine oil drain bolt

To change the engine oil

1. Start the engine, warm it up for several minutes, and then turn it off.
2. Place an oil pan under the engine to collect the used oil.
3. Remove the engine oil filler cap and the engine oil drain bolt to drain the oil from the crankcase.

PERIODIC MAINTENANCE AND MINOR REPAIR

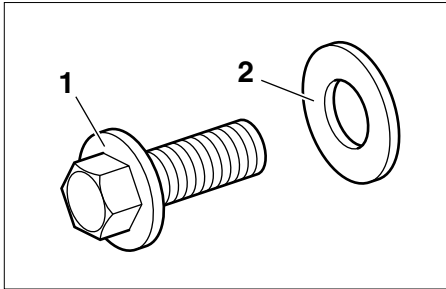

1. Engine oil drain bolt
2. Washer

4. Check the washer for damage and replace it if necessary.
5. Install the washer and the engine oil drain bolt, and then tighten the drain bolt to the specified torque.

Tightening torque:
Engine oil drain bolt:
20 Nm (2.0 m·kgf)

NOTE: _____
Make sure that the washer is properly seated.

6. Add the specified amount of the recommended engine oil, and then install and tighten the oil filler cap.

Recommended engine oil:

See page 8-1.

Oil quantity:

Periodic oil change:

1.2 L

Total amount (dry engine):

1.4 L

EC000030

CAUTION: _____

- Do not put in any chemical additives or use oils with a grade of CD or higher. Also, be sure not to use oils labeled “ENERGY CONSERVING II” or higher.
- Be sure no foreign material enters the crankcase.

7. Start the engine, and then let it idle for several minutes while checking it for oil leakage. If oil is leaking, immediately turn the engine off and check for the cause.
8. Reset the oil change indicator light according to the following procedure.

PERIODIC MAINTENANCE AND MINOR REPAIR

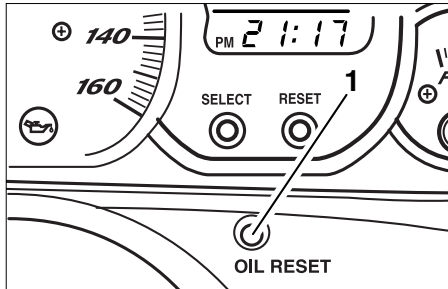

1. Reset button

To reset the oil change indicator light

1. Turn the key to "ON".

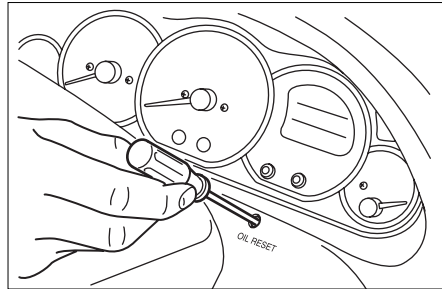

2. Hold the reset button pushed for two to five seconds.
3. Release the reset button, and the oil change indicator light will go off.

NOTE:

If the engine oil is changed before the oil change indicator light comes on (i.e. before the periodic oil change interval has been reached), the indicator light must be reset after the oil change for the next periodic oil change to be indicated at the correct time. To reset the oil change indicator light before the periodic oil change interval has been reached, follow the above procedure, but note that the indicator light will come on for 1.4 seconds after releasing the reset button, otherwise repeat the procedure.

PERIODIC MAINTENANCE AND MINOR REPAIR

EAU04228

Final transmission oil

The final transmission case must be checked for oil leakage before each ride. If any leakage is found, have a Yamaha dealer check and repair the scooter. In addition, the final transmission oil must be changed as follows at the intervals specified in the periodic maintenance and lubrication chart.

1. Start the engine, warm it up by riding the scooter for several minutes, and then stop the engine.
2. Place the scooter on the center-stand.
3. Place an oil pan under the final transmission case to collect the used oil.

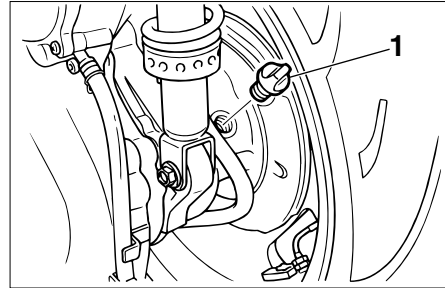

1. Final transmission oil filler cap

4. Remove the oil filler cap and drain bolt to drain the oil from the final transmission case.
5. Install the final transmission oil drain bolt, and then tighten it to the specified torque.

Tightening torque:

Final transmission oil drain bolt:
22 Nm (2.2 m·kgf)

6. Add the specified amount of the recommended final transmission oil, and then install and tighten the oil filler cap.

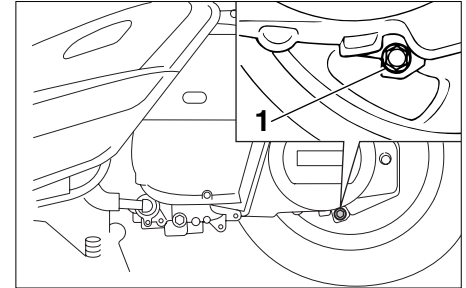

1. Final transmission oil drain bolt

Recommended final transmission oil:

See page 8-2.

Oil quantity:
0.25 L

EWA00062

⚠ WARNING

- Make sure that no foreign material enters the final transmission case.
- Make sure that no oil gets on the tire or wheel.

PERIODIC MAINTENANCE AND MINOR REPAIR

7. Check the final transmission case for oil leakage. If oil is leaking, check for the cause.

EAU04591

Coolant

The coolant reservoir is located under the battery cover. (See page 6-34 for battery cover removal and installation procedures.)

To check the coolant level

1. Place the scooter on a level surface and hold it in an upright position.

NOTE: _____

- The coolant level must be checked on a cold engine since the level varies with engine temperature.
- Make sure that the scooter is positioned straight up when checking the coolant level. A slight tilt to the side can result in a false reading.

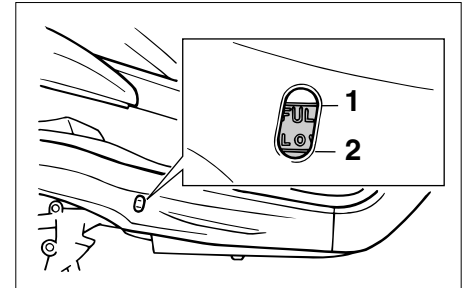

1. Maximum level mark
2. Minimum level mark

2. Check the coolant level in the coolant reservoir.

NOTE: _____

The coolant should be between the minimum and maximum level marks.

PERIODIC MAINTENANCE AND MINOR REPAIR

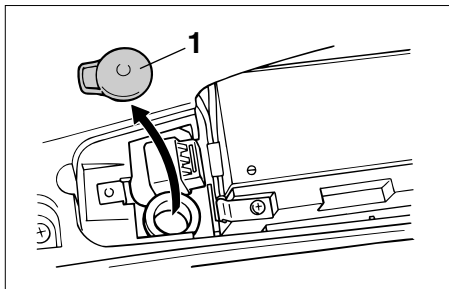

1. Coolant reservoir cap

3. If the coolant is at or below the minimum level mark, remove the reservoir cap, add coolant to the maximum level mark, and then install the reservoir cap.

Coolant reservoir capacity:
0.4 L

4. Install the battery cover.

EC000080

CAUTION: _____

- If coolant is not available, use distilled water or soft tap water instead. Do not use hard water or salt water since it is harmful to the engine.
- If water has been used instead of coolant, replace it with coolant as soon as possible, otherwise the engine may not be sufficiently cooled and the cooling system will not be protected against frost and corrosion.
- If water has been added to the coolant, have a Yamaha dealer check the antifreeze content of the coolant as soon as possible, otherwise the effectiveness of the coolant will be reduced.

NOTE: _____

The radiator fan is automatically switched on or off according to the coolant temperature in the radiator. If the engine overheats, see page 6-44 for further instructions.

PERIODIC MAINTENANCE AND MINOR REPAIR

EAU03627

Air filter and V-belt case air filter elements

The air filter and V-belt case air filter elements should be cleaned at the intervals specified in the periodic maintenance and lubrication chart. Clean both filter elements more frequently if you are riding in unusually wet or dusty areas.

EC000092

CAUTION:

- Make sure that each filter element is properly seated in its case.
- The engine should never be operated without the filter elements installed, otherwise the piston and/or cylinder may become excessively worn.

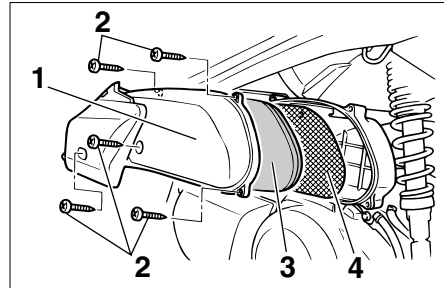

1. Air filter case cover
2. Screw (x5)
3. Sponge material
4. Mesh sheet

Cleaning the air filter element

1. Place the scooter on the center-stand.
2. Remove the air filter case cover by removing the screws.
3. Pull the sponge material out along with the mesh sheet, clean it with solvent, and then squeeze the remaining solvent out.

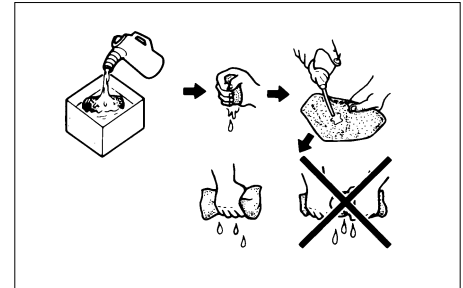

4. Check the sponge material for damage and replace it if necessary.
5. Allow the sponge material to dry.
6. Apply oil of the recommended type to the entire surface of the sponge material, and then squeeze the excess oil out.

PERIODIC MAINTENANCE AND MINOR REPAIR

NOTE:

The sponge material should be wet but not dripping.

Recommended oil:
Engine oil

7. Insert the sponge material into the air filter case.
8. Install the air filter case cover by installing the screws.

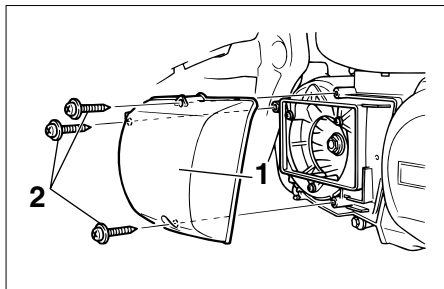

1. V-belt case air filter cover
2. Screw (×3)

Cleaning the V-belt case air filter element

1. Remove cowling A. (See page 6-7 for cowling removal and installation procedures.)
2. Remove the air filter case cover by removing the screws.
3. Remove the V-belt case air filter cover by removing the screws.

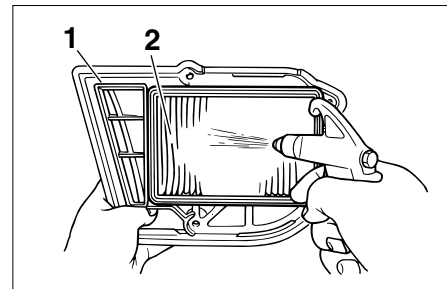

1. V-belt case air filter cover
2. V-belt case air filter element

4. Blow the dirt out of the air filter element with compressed air as shown.
5. Check the V-belt case air filter element for damage and replace it if necessary.
6. Install the V-belt case air filter element cover by installing the screws.
7. Install the air filter case cover by installing the screws.
8. Install the cowling.

PERIODIC MAINTENANCE AND MINOR REPAIR

EAU00637

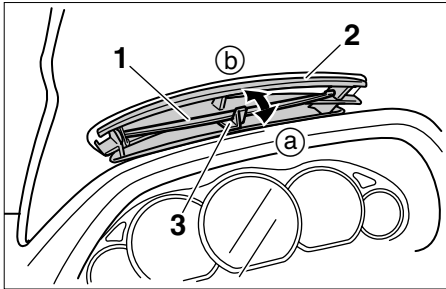

1. Air flow louver
2. Air inlet
3. Lever

EAU03094

Air flow louver

Opening the air flow louver may help reduce air turbulence.

To open the air flow louver

Move the lever in direction (a).

To close the air flow louver

Move the lever in direction (b).

ECA00049

CAUTION:

Be sure to close the louver when riding in the rain and when washing the scooter.

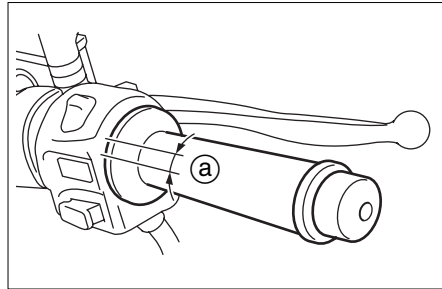

- a. Throttle cable free play

EAU00635

Adjusting the throttle cable free play

The throttle cable free play should measure 3–5 mm at the throttle grip. Periodically check the throttle cable free play and, if necessary, have a Yamaha dealer adjust it.

Adjusting the valve clearance

The valve clearance changes with use, resulting in improper air-fuel mixture and/or engine noise. To prevent this from occurring, the valve clearance must be adjusted by a Yamaha dealer at the intervals specified in the periodic maintenance and lubrication chart.

PERIODIC MAINTENANCE AND MINOR REPAIR

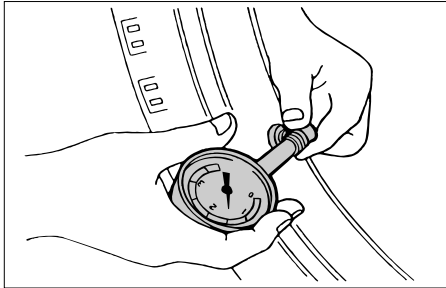

EAU04551

Tires

To maximize the performance, durability, and safe operation of your scooter, note the following points regarding the specified tires.

Tire air pressure

The tire air pressure should be checked and, if necessary, adjusted before each ride.

EW000082

⚠ WARNING

- The tire air pressure must be checked and adjusted on cold tires (i.e., when the temperature of the tires equals the ambient temperature).
- The tire air pressure must be adjusted in accordance with the riding speed and with the total weight of rider, passenger, cargo, and accessories approved for this model.

| Tire air pressure (measured on cold tires) | | |
|---|---|---|
| Load* | Front | Rear |
| Up to 90 kg | 175 kPa (1.75kgf/cm ² , 1.75 bar) | 200 kPa (2.00kgf/cm ² , 2.00 bar) |
| 90 kg load–maximum | 200 kPa (2.00 kgf/cm ² , 2.00 bar) | 225 kPa (2.25 kgf/cm ² , 2.25 bar) |

| | |
|---------------|--------|
| Maximum load* | 185 kg |
|---------------|--------|

* Total weight of rider, passenger, cargo and accessories

PERIODIC MAINTENANCE AND MINOR REPAIR

⚠ WARNING

EW000077

Because loading has an enormous impact on the handling, braking, performance and safety characteristics of your scooter, you should keep the following precautions in mind.

- **NEVER OVERLOAD THE SCOOTER!** Operation of an overloaded scooter may result in tire damage, loss of control, or severe injury. Make sure that the total weight of rider, cargo, and accessories does not exceed the specified maximum load for the vehicle.
- Do not carry along loosely packed items, which can shift during a ride.
- Securely pack the heaviest items close to the center of the scooter and distribute the weight evenly on both sides.

- Adjust the suspension and tire air pressure with regard to the load.
- Check the tire condition and air pressure before each ride.

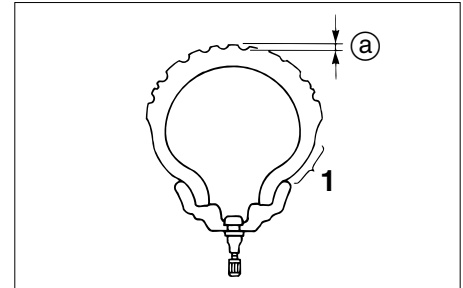

- 1. Sidewall
- a. Tire tread depth

Tire inspection

The tires must be checked before each ride. If the center tread depth reaches the specified limit, if the tire has a nail or glass fragments in it, or if the sidewall is cracked, have a Yamaha dealer replace the tire immediately.

| | |
|--|--------|
| Minimum tire tread depth (front and rear) | 1.6 mm |
|--|--------|

PERIODIC MAINTENANCE AND MINOR REPAIR

NOTE: _____

The tire tread depth limits may differ from country to country. Always comply with the local regulations.

Tire information

This scooter is equipped with tubeless tires.

FRONT

| Manufacturer | Size | Model |
|--------------|---------------|--------|
| IRC | 110/90-12 64L | MB67 |
| MICHELIN | 110/90-12 64L | BOPPER |

REAR

| Manufacturer | Size | Model |
|--------------|---------------|--------|
| IRC | 130/70-12 62L | MB67 |
| MICHELIN | 130/70-12 62L | BOPPER |

EAU00683

⚠ WARNING _____

- **Have a Yamaha dealer replace excessively worn tires. Besides being illegal, operating the scooter with excessively worn tires decreases riding stability and can lead to loss of control.**
- **The replacement of all wheel and brake related parts, including the tires, should be left to a Yamaha dealer, who has the necessary professional knowledge and experience.**

EAU03773

Cast wheels

To maximize the performance, durability, and safe operation of your scooter, note the following points regarding the specified wheels.

- The wheel rims should be checked for cracks, bends or warpage before each ride. If any damage is found, have a Yamaha dealer replace the wheel. Do not attempt even the smallest repair to the wheel. A deformed or cracked wheel must be replaced.
- The wheel should be balanced whenever either the tire or wheel has been changed or replaced. An unbalanced wheel can result in poor performance, adverse handling characteristics, and a shortened tire life.

PERIODIC MAINTENANCE AND MINOR REPAIR

- Ride at moderate speeds after changing a tire since the tire surface must first be “broken in” for it to develop its optimal characteristics.

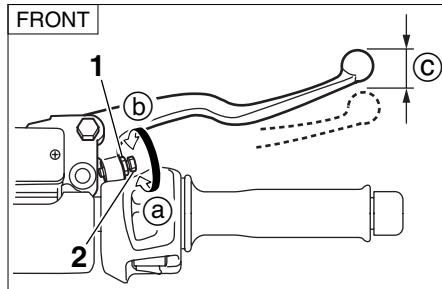

1. Locknut
2. Adjusting bolt
- c. Brake lever free play

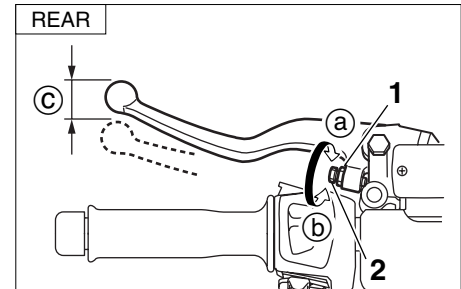

1. Locknut
2. Adjusting bolt
- c. Brake lever free play

EAU00703

Adjusting the front and rear brake lever free play

The front and rear brake lever free play should measure 2–5 mm as shown. Periodically check the front and rear brake lever free play and, if necessary, adjust them as follows.

1. Loosen the locknut at the brake lever.
2. To increase the brake lever free play, turn the adjusting bolt in direction (a). To decrease the brake lever free play, turn the adjusting bolt in direction (b).
3. Tighten the locknut.

EW000101

⚠ WARNING

If proper adjustment cannot be obtained as described, have a Yamaha dealer make this adjustment.

PERIODIC MAINTENANCE AND MINOR REPAIR

Checking the front and rear brake pads

EAU00721

The front and rear brake pads must be checked for wear at the intervals specified in the periodic maintenance and lubrication chart.

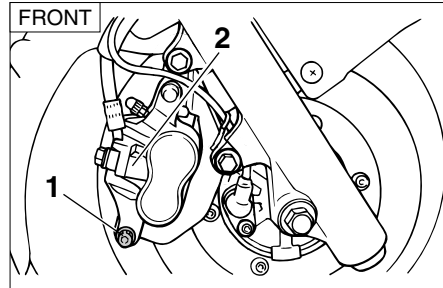

1. Brake caliper bolt
2. Brake caliper

EAU04583

Front brake pads

Each front brake pad is provided with a wear indicator groove, which allows you to check the brake pad wear without having to disassemble the brake. Check the brake pad wear as follows.

1. Remove the brake caliper bolt, and then tilt the caliper forward to inspect the wear indicator groove. If a brake pad has worn to the point that the wear indicator groove has almost disappeared, have a Yamaha dealer replace the brake pads as a set.

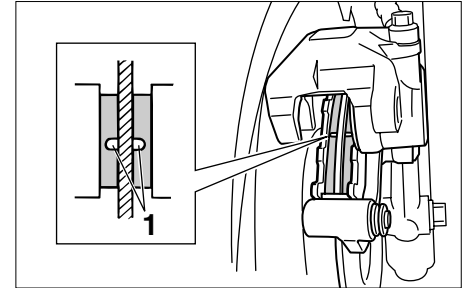

1. Wear indicator groove (x2)
2. Install the brake caliper bolt, and then tighten it to the specified torque.

Tightening torque:
Brake caliper bolt:
26.5 Nm (2.65 m·kgf)

PERIODIC MAINTENANCE AND MINOR REPAIR

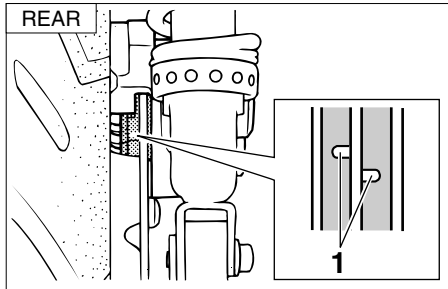

1. Wear indicator groove (x2)

EAU03939

Rear brake pads

Each rear brake pad is provided with a wear indicator groove, which allows you to check the brake pad wear without having to disassemble the brake. To check the brake pad wear, check the wear indicator groove. If a brake pad has worn to the point that the wear indicator groove has almost disappeared, have a Yamaha dealer replace the brake pads as a set.

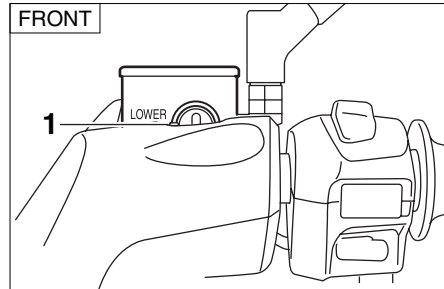

1. Minimum level mark

EAU03294

Checking the brake fluid level

Insufficient brake fluid may allow air to enter the brake system, possibly causing it to become ineffective. Before riding, check that the brake fluid is above the minimum level mark and replenish if necessary. A low brake fluid level may indicate worn brake pads and/or brake system leakage. If the brake level is low, be sure to check the brake pads for wear and the brake system for leakage.

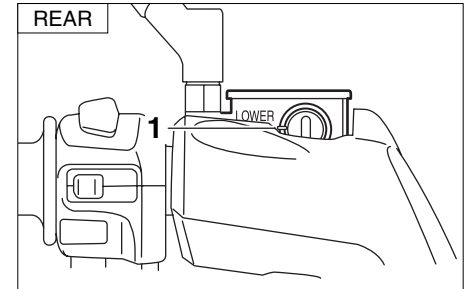

1. Minimum level mark

Observe these precautions:

- When checking the fluid level, make sure that the top of the brake fluid reservoir is level.
- Use only the recommended quality brake fluid, otherwise the rubber seals may deteriorate, causing leakage and poor braking performance.

Recommended brake fluid:
DOT 4

- Refill with the same type of brake fluid. Mixing fluids may result in a harmful chemical reaction and lead to poor braking performance.
- Be careful that water does not enter the brake fluid reservoir when refilling. Water will significantly lower the boiling point of the fluid and may result in vapor lock.
- Brake fluid may deteriorate painted surfaces or plastic parts. Always clean up spilled fluid immediately.
- As the brake pads wear, it is normal for the brake fluid level to gradually go down. However, if the brake fluid level goes down suddenly, have a Yamaha dealer check the cause.

EAU03976

Changing the brake fluid

Have a Yamaha dealer change the brake fluid at the intervals specified in the NOTE after the periodic maintenance and lubrication chart. In addition, have the oil seals of the master cylinders and calipers as well as the brake hoses replaced at the intervals listed below or whenever they are damaged or leaking.

- Oil seals: Replace every two years.
- Brake hoses: Replace every four years.

EAU02962

Checking and lubricating the cables

The operation of all control cables and the condition of the cables should be checked before each ride, and the cables and cable ends should be lubricated if necessary. If a cable is damaged or does not move smoothly, have a Yamaha dealer check or replace it.

Recommended lubricant:
Engine oil

EW000112

⚠ WARNING

Damage to the outer sheath may interfere with proper cable operation and will cause the inner cable to rust. Replace a damaged cable as soon as possible to prevent unsafe conditions.

PERIODIC MAINTENANCE AND MINOR REPAIR

EAU04034

Checking and lubricating the throttle grip and cable

The operation of the throttle grip should be checked before each ride. In addition, the cable should be lubricated or replaced at the intervals specified in the periodic maintenance chart.

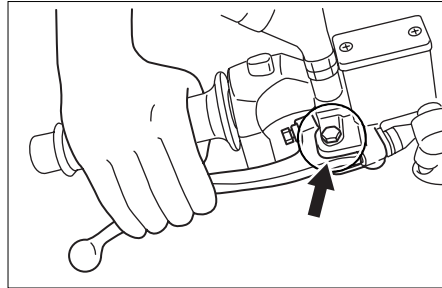

EAU03118

Lubricating the front and rear brake levers

The pivoting points of the front and rear brake levers must be lubricated at the intervals specified in the periodic maintenance and lubrication chart.

Recommended lubricant:
Lithium-soap-based grease
(all-purpose grease)

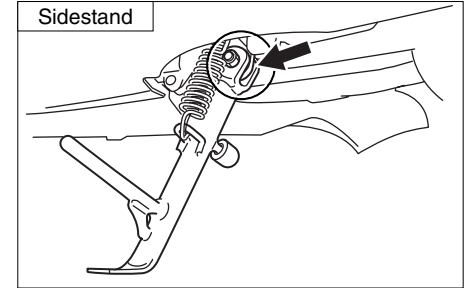

EAU03371

Checking and lubricating the centerstand and sidestand

The operation of the centerstand and sidestand should be checked before each ride, and the pivots and metal-to-metal contact surfaces should be lubricated if necessary.

EW000114

⚠ WARNING

If the centerstand or sidestand does not move up and down smoothly, have a Yamaha dealer check or repair it.

PERIODIC MAINTENANCE AND MINOR REPAIR

Centerstand

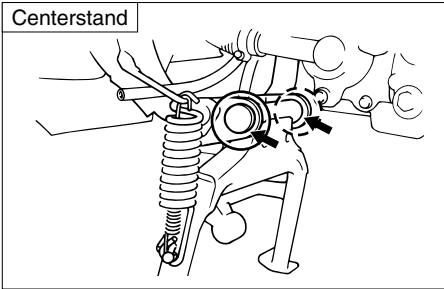

EAU02939

Checking the front fork

The condition and operation of the front fork must be checked as follows at the intervals specified in the periodic maintenance and lubrication chart.

To check the condition

EW000115

⚠ WARNING

Securely support the scooter so that there is no danger of it falling over.

Check the inner tubes for scratches, damage and excessive oil leakage.

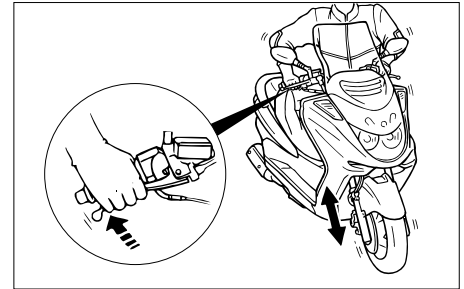

To check the operation

1. Place the scooter on a level surface and hold it in an upright position.
2. While applying the front brake, push down hard on the handlebars several times to check if the front fork compresses and rebounds smoothly.

EC000098

CAUTION:

If any damage is found or the front fork does not operate smoothly, have a Yamaha dealer check or repair it.

Recommended lubricant:
Lithium-soap-based grease
(all-purpose grease)

PERIODIC MAINTENANCE AND MINOR REPAIR

EAU00794

Checking the steering

Worn or loose steering bearings may cause danger. Therefore, the operation of the steering must be checked as follows at the intervals specified in the periodic maintenance and lubrication chart.

1. Place a stand under the engine to raise the front wheel off the ground.

EW000115

⚠ WARNING

Securely support the scooter so that there is no danger of it falling over.

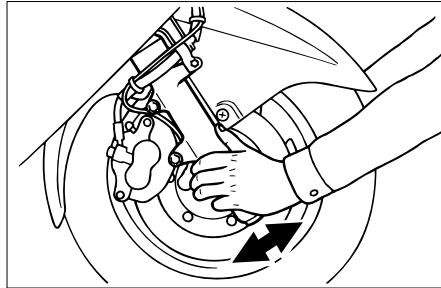

2. Hold the lower ends of the front fork legs and try to move them forward and backward. If any free play can be felt, have a Yamaha dealer check or repair the steering.

EAU01144

Checking the wheel bearings

The front and rear wheel bearings must be checked at the intervals specified in the periodic maintenance and lubrication chart. If there is play in the wheel hub or if the wheel does not turn smoothly, have a Yamaha dealer check the wheel bearings.

PERIODIC MAINTENANCE AND MINOR REPAIR

EAU0417

Removing the battery cover

The battery cover needs to be removed to access the battery, the fuse box and the coolant reservoir cap.

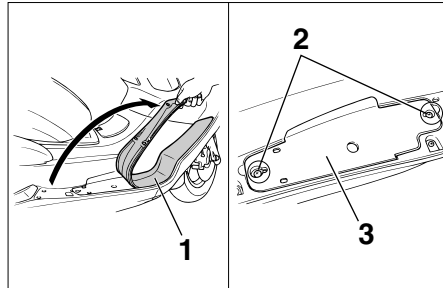

1. Right footboard mat
2. Screw (×2)
3. Battery cover

To remove the battery cover, pull up the right footboard mat as shown, and then remove the screws and the battery cover.

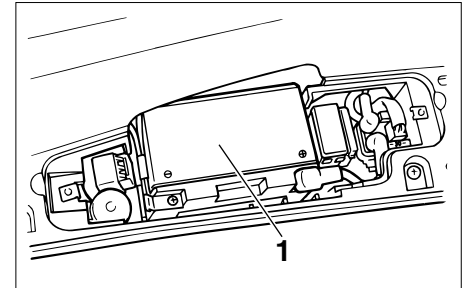

1. Battery

EAU01271

Battery

This scooter is equipped with a sealed-type (MF) battery, which does not require any maintenance. There is no need to check the electrolyte or to add distilled water.

To charge the battery

Have a Yamaha dealer charge the battery as soon as possible if it seems to have discharged. Keep in mind that the battery tends to discharge more quickly if the scooter is equipped with optional electrical accessories.

PERIODIC MAINTENANCE AND MINOR REPAIR

EW000116

⚠️ WARNING

- **Electrolyte is poisonous and dangerous since it contains sulfuric acid, which causes severe burns. Avoid any contact with skin, eyes or clothing and always shield your eyes when working near batteries. In case of contact, administer the following FIRST AID.**
 - **EXTERNAL:** Flush with plenty of water.
 - **INTERNAL:** Drink large quantities of water or milk and immediately call a physician.
 - **EYES:** Flush with water for 15 minutes and seek prompt medical attention.

- **Batteries produce explosive hydrogen gas. Therefore, keep sparks, flames, cigarettes, etc., away from the battery and provide sufficient ventilation when charging it in an enclosed space.**
 - **KEEP THIS AND ALL BATTERIES OUT OF THE REACH OF CHILDREN.**
-

To store the battery

1. If the scooter will not be used for more than one month, remove the battery, fully charge it, and then place it in a cool, dry place.
2. If the battery will be stored for more than two months, check it at least once a month and fully charge it if necessary.
3. Fully charge the battery before installation.

PERIODIC MAINTENANCE AND MINOR REPAIR

EC000102

CAUTION:

- Always keep the battery charged. Storing a discharged battery can cause permanent battery damage.
- To charge a sealed-type (MF) battery, a special (constant-voltage) battery charger is required. Using a conventional battery charger will damage the battery. If you do not have access to a sealed-type (MF) battery charger, have a Yamaha dealer charge your battery.

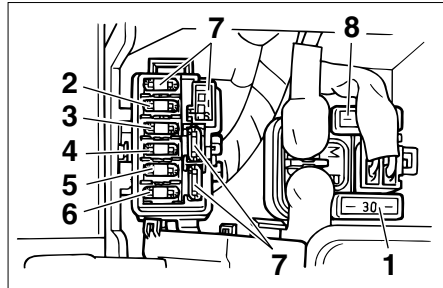

1. Main fuse
2. Backup fuse (clock)
3. Radiator fan fuse
4. Ignition fuse
5. Headlight fuse
6. Signaling system fuse
7. Spare fuse (x4)
8. Spare main fuse

EAU04110

Replacing the fuses

The fuse boxes are located under the battery cover. (See page 6-34 for battery cover removal and installation procedures.)

If a fuse is blown, replace it as follows.

1. Turn the key to "OFF" and turn off all electrical circuits.

2. Remove the blown fuse, and then install a new fuse of the specified amperage.

Specified fuses:

| | |
|------------------------|-------|
| Main fuse: | 30 A |
| Backup fuse (clock): | 10 A |
| Radiator fan fuse: | 4 A |
| Ignition fuse: | 7.5 A |
| Headlight fuse: | 15 A |
| Signaling system fuse: | 15 A |

EC000103

CAUTION:

Do not use a fuse of a higher amperage rating than recommended to avoid causing extensive damage to the electrical system and possibly a fire.

3. Turn the key to "ON" and turn on the electrical circuit in question to check if the device operates.

PERIODIC MAINTENANCE AND MINOR REPAIR

4. If the fuse immediately blows again, have a Yamaha dealer check the electrical system.

EAU04128

Replacing a headlight bulb

This scooter is equipped with quartz bulb headlights. If a headlight bulb burns out, replace it as follows.

1. Place the scooter on the center-stand.
2. Remove panel A. (See page 6-11 for panel removal and installation procedures.)

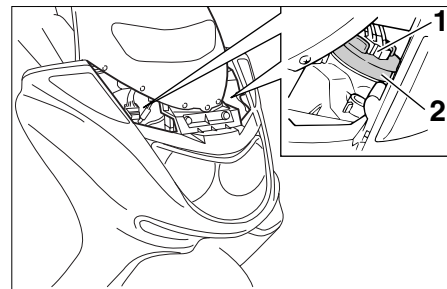

1. Headlight coupler
2. Bulb cover
3. Disconnect the headlight coupler, and then remove the bulb cover.

PERIODIC MAINTENANCE AND MINOR REPAIR

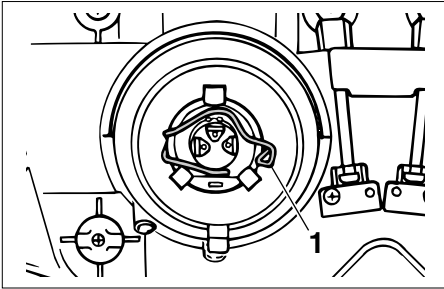

1. Headlight bulb holder

4. Unhook the headlight bulb holder, and then remove the defective bulb.

EW000119

⚠ WARNING

Headlight bulbs get very hot. Therefore, keep flammable products away from a lit headlight bulb, and do not touch the bulb until it has cooled down.

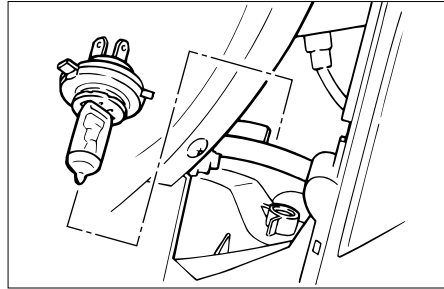

5. Place a new headlight bulb into position, and then secure it with the bulb holder.

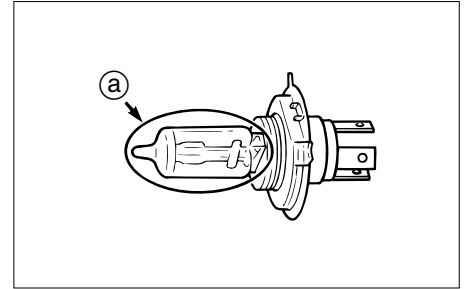

- a. Do not touch the glass part of the bulb.

EC000105

CAUTION:

Do not touch the glass part of the headlight bulb to keep it free from oil, otherwise the transparency of the glass, the luminosity of the bulb, and the bulb life will be adversely affected. Thoroughly clean off any dirt and fingerprints on the headlight bulb using a cloth moistened with alcohol or thinner.

6. Install the headlight bulb cover, and then connect the coupler.

PERIODIC MAINTENANCE AND MINOR REPAIR

7. Install the panel.
8. Have a Yamaha dealer adjust the headlight beam if necessary.

Replacing a front turn signal light bulb

EAU03111

1. Place the scooter on the center-stand.
2. Remove panel A. (See page 6-11 for panel removal and installation procedures.)

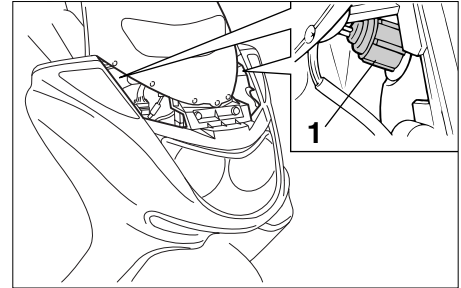

1. Socket

3. Remove the socket (together with the turn signal light bulb) by turning it counterclockwise.
4. Remove the defective bulb by pushing it in and turning it counterclockwise.
5. Insert a new bulb into the socket, push it in, and then turn it clockwise until it stops.
6. Install the socket (together with the bulb) by turning it clockwise.
7. Install the panel.

PERIODIC MAINTENANCE AND MINOR REPAIR

EAU03618

Replacing a rear turn signal light bulb

1. Place the scooter on the center-stand.
2. Remove cowling C. (See page 6-10 for cowling removal and installation procedures.)

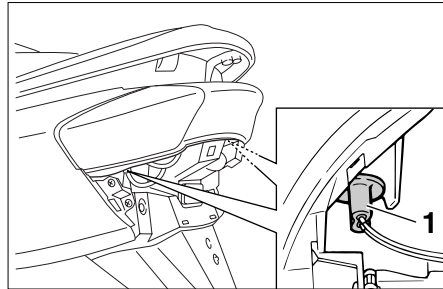

1. Socket
3. Remove the socket (together with the bulb) by turning it counterclockwise.
4. Remove the defective bulb by pulling it out.
5. Insert a new bulb into the socket.
6. Install the socket (together with the bulb) by turning it clockwise.
7. Install the cowling.

EAU03619

Replacing a tail/brake light bulb

1. Place the scooter on the center-stand.
2. Remove cowling C. (See page 6-10 for cowling removal and installation procedures.)

PERIODIC MAINTENANCE AND MINOR REPAIR

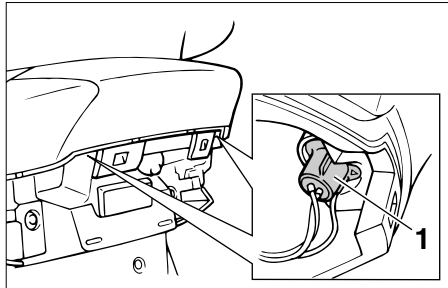

1. Socket

3. Remove the socket (together with the bulb) by turning it counterclockwise.
4. Remove the defective bulb by pushing it in and turning it counterclockwise.
5. Insert a new bulb into the socket, push it in, and then turn it clockwise until it stops.
6. Install the socket (together with the bulb) by turning it clockwise.
7. Install the cowling.

EAU03621

Replacing the license plate light bulb

1. Place the scooter on the center-stand.
2. Remove cowling C. (See page 6-10 for cowling removal and installation procedures.)

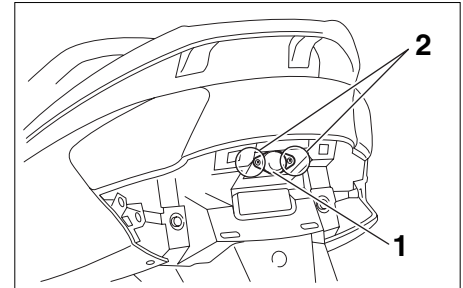

1. License plate light lens
2. Screw (x2)

3. Remove the license plate light lens by removing the screws.

EAU03087

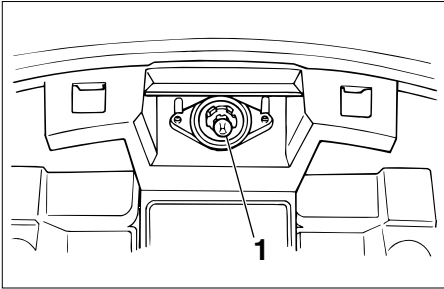

1. Bulb

4. Remove the defective bulb by pulling it out.
5. Insert a new bulb into the socket.
6. Install the lens by installing the screws.

EC000108

CAUTION: _____

Do not overtighten the screws, otherwise the lens may break.

7. Install the cowling.

Troubleshooting

Although Yamaha scooters receive a thorough inspection before shipment from the factory, trouble may occur during operation. Any problem in the fuel, compression, or ignition systems, for example, can cause poor starting and loss of power.

The following troubleshooting charts represent quick and easy procedures for checking these vital systems yourself. However, should your scooter require any repair, take it to a Yamaha dealer, whose skilled technicians have the necessary tools, experience, and know-how to service the scooter properly.

Use only genuine Yamaha replacement parts. Imitation parts may look like Yamaha parts, but they are often inferior, have a shorter service life and can lead to expensive repair bills.

PERIODIC MAINTENANCE AND MINOR REPAIR

EAU01581

Troubleshooting charts

Starting problems or poor engine performance

EW000125



Keep away open flames and do not smoke while checking or working on the fuel system.

1. Fuel

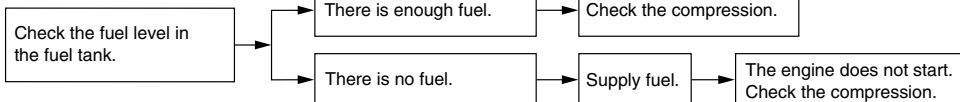

2. Compression

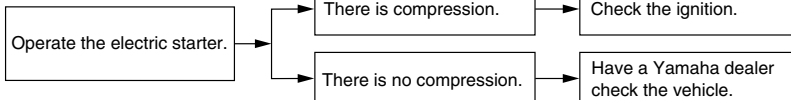

3. Ignition

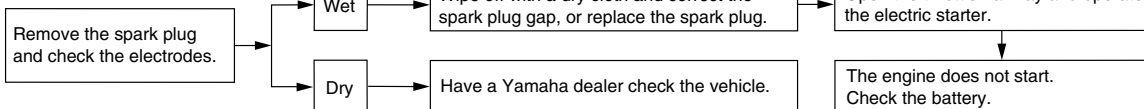

4. Battery

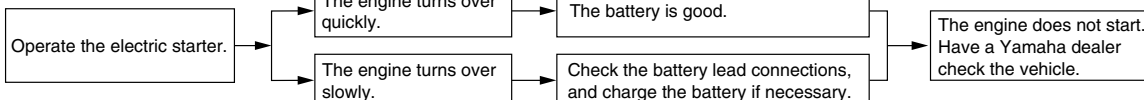

PERIODIC MAINTENANCE AND MINOR REPAIR

Engine overheating

EW000070

⚠ WARNING

- Do not remove the radiator cap when the engine and radiator are hot. Scalding hot fluid and steam may be blown out under pressure, which could cause serious injury. Be sure to wait until the engine has cooled.
- After removing the radiator cap retaining bolt, place a thick rag, like a towel, over the radiator cap, and then slowly rotate the cap counterclockwise to the detent to allow any residual pressure to escape. When the hissing sound has stopped, press down on the cap while turning it counterclockwise, and then remove the cap.

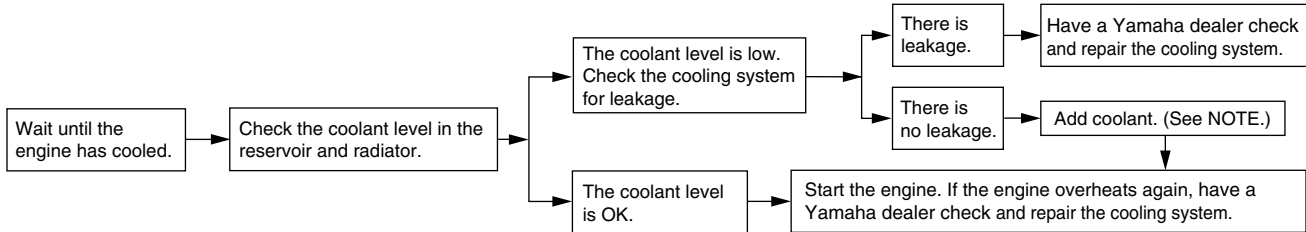

NOTE:

If coolant is not available, tap water can be temporarily used instead, provided that it is changed to the recommended coolant as soon as possible.

SCOOTER CARE AND STORAGE

| | |
|---------------|-----|
| Care | 7-1 |
| Storage | 7-4 |

SCOOTER CARE AND STORAGE

Care

While the open design of a scooter reveals the attractiveness of the technology, it also makes it more vulnerable. Rust and corrosion can develop even if high-quality components are used. A rusty exhaust pipe may go unnoticed on a car, however, it detracts from the overall appearance of a scooter. Frequent and proper care does not only comply with the terms of the warranty, but it will also keep your scooter looking good, extend its life and optimize its performance.

Before cleaning

1. Cover the muffler outlet with a plastic bag after the engine has cooled down.
2. Make sure that all caps and covers as well as all electrical couplers and connectors, including the spark plug cap, are tightly installed.
3. Remove extremely stubborn dirt, like oil burnt onto the crankcase, with a degreasing agent and a brush, but never apply such products onto seals, gaskets and wheel axles. Always rinse the dirt and degreaser off with water.

Cleaning

ECA00011

CAUTION:

- **Avoid using strong acidic wheel cleaners, especially on spoked wheels. If such products are used on hard-to-remove dirt, do not leave the cleaner on the affected area any longer than instructed. Also, thoroughly rinse the area off with water, immediately dry it, and then apply a corrosion protection spray.**
- **Improper cleaning can damage windshields, cowlings, panels and other plastic parts. Use only a soft, clean cloth or sponge with mild detergent and water to clean plastic.**

SCOOTER CARE AND STORAGE

- Do not use any harsh chemical products on plastic parts. Be sure to avoid using cloths or sponges which have been in contact with strong or abrasive cleaning products, solvent or thinner, fuel (gasoline), rust removers or inhibitors, brake fluid, antifreeze or electrolyte.
 - Do not use high-pressure washers or steam-jet cleaners since they cause water seepage and deterioration in the following areas: seals (of wheel and swingarm bearings, fork and brakes), electric components (couplers, connectors, instruments, switches and lights), breather hoses and vents.
- For scooters equipped with a windshield: Do not use strong cleaners or hard sponges as they will cause dulling or scratching. Some cleaning compounds for plastic may leave scratches on the windshield. Test the product on a small hidden part of the windshield to make sure that it does not leave any marks. If the windshield is scratched, use a quality plastic polishing compound after washing.

After normal use

Remove dirt with warm water, a mild detergent, and a soft, clean sponge, and then rinse thoroughly with clean water. Use a toothbrush or bottle-brush for hard-to-reach areas. Stubborn dirt and insects will come off more easily if the area is covered with a wet cloth for a few minutes before cleaning.

After riding in the rain, near the sea or on salt-sprayed roads

Since sea salt or salt sprayed on the roads during winter are extremely corrosive in combination with water, carry out the following steps after each ride in the rain, near the sea or on salt-sprayed roads.

NOTE: _____
Salt sprayed on roads in the winter may remain well into spring.

1. Clean the scooter with cold water and a mild detergent after the engine has cooled down.

CAUTION: _____

Do not use warm water since it increases the corrosive action of the salt.

2. Apply a corrosion protection spray on all metal, including chrome- and nickel-plated, surfaces to prevent corrosion.

ECA00012

SCOOTER CARE AND STORAGE

After cleaning

1. Dry the scooter with a chamois or an absorbing cloth.
2. Use a chrome polish to shine chrome, aluminum and stainless-steel parts, including the exhaust system. (Even the thermally induced discoloring of stainless-steel exhaust systems can be removed through polishing.)
3. To prevent corrosion, it is recommended to apply a corrosion protection spray on all metal, including chrome- and nickel-plated, surfaces.
4. Use spray oil as a universal cleaner to remove any remaining dirt.
5. Touch up minor paint damage caused by stones, etc.

6. Wax all painted surfaces.
7. Let the scooter dry completely before storing or covering it.

⚠ WARNING

EWA00002

- **Make sure that there is no oil or wax on the brakes or tires. If necessary, clean the brake discs and brake linings with a regular brake disc cleaner or acetone, and wash the tires with warm water and a mild detergent.**
- **Before operating the scooter test its braking performance and cornering behavior.**

ECA00013

CAUTION:

- **Apply spray oil and wax sparingly and make sure to wipe off any excess.**
- **Never apply oil or wax to any rubber and plastic parts, but treat them with a suitable care product.**
- **Avoid using abrasive polishing compounds as they will wear away the paint.**

NOTE:

Consult a Yamaha dealer for advice on what products to use.

Storage

Short-term

Always store your scooter in a cool, dry place and, if necessary, protect it against dust with a porous cover.

ECA00015

CAUTION:

- **Storing the scooter in a poorly ventilated room or covering it with a tarp, while it is still wet, will allow water and humidity to seep in and cause rust.**
- **To prevent corrosion, avoid damp cellars, stables (because of the presence of ammonia) and areas where strong chemicals are stored.**

Long-term

Before storing your scooter for several months:

1. Follow all the instructions in the “Care” section of this chapter.
2. Drain the carburetor float chamber by loosening the drain bolt; this will prevent fuel deposits from building up. Pour the drained fuel into the fuel tank.
3. Fill up the fuel tank and add fuel stabilizer (if available) to prevent the fuel tank from rusting and the fuel from deteriorating.
4. Perform the following steps to protect the cylinder, piston rings, etc. from corrosion.

- a. Remove the spark plug cap and spark plug.
- b. Pour a teaspoonful of engine oil into the spark plug bore.
- c. Install the spark plug cap onto the spark plug, and then place the spark plug on the cylinder head so that the electrodes are grounded. (This will limit sparking during the next step.)
- d. Turn the engine over several times with the starter. (This will coat the cylinder wall with oil.)
- e. Remove the spark plug cap from the spark plug, and then install the spark plug and the spark plug cap.

EWA00003

⚠ WARNING

To prevent damage or injury from sparking, make sure to ground the spark plug electrodes while turning the engine over.

SCOOTER CARE AND STORAGE

5. Lubricate all control cables and the pivoting points of all levers and pedals as well as of the sidestand/centerstand.
6. Check and, if necessary, correct the tire air pressure, and then lift the scooter so that both of its wheels are off the ground. Alternatively, turn the wheels a little every month in order to prevent the tires from becoming degraded in one spot.
7. Cover the muffler outlet with a plastic bag to prevent moisture from entering it.
8. Remove the battery and fully charge it. Store it in a cool, dry place and charge it once a month. Do not store the battery in an excessively cold or warm place [less than 0 °C or more than 30 °C]. For more information on storing the battery, see page 6-35.

NOTE: _____
Make any necessary repairs before storing the scooter.

| | |
|------------------------|-----|
| Specifications | 8-1 |
| Conversion table | 8-5 |

SPECIFICATIONS

Specifications

| | |
|---|----------------------------------|
| Model | YP250 |
| Dimensions | |
| Overall length | 2,145 mm |
| Overall width | 770 mm |
| Overall height | 1,350 mm |
| Seat height | 730 mm |
| Wheelbase | 1,535 mm |
| Ground clearance | 120 mm |
| Minimum turning radius | 2,700 mm |
| Basic weight (with oil and full fuel tank) | 170 kg |
| Engine | |
| Engine type | Liquid-cooled 4-stroke, SOHC |
| Cylinder arrangement | Forward inclined single cylinder |
| Displacement | 249 cm ³ |
| Bore × Stroke | 69.0 × 66.8 mm |
| Compression ratio | 10:1 |
| Starting system | Electric starter |
| Lubrication system | Wet sump |

Engine oil

Type

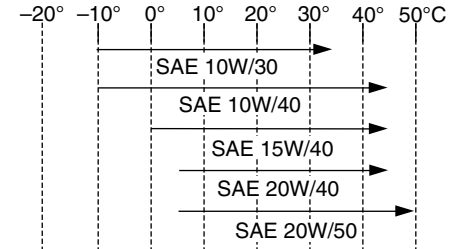

Recommended engine oil classification

API Service SE, SF, SG type or higher

CAUTION:

Be sure to use motor oils that do not contain anti-friction modifiers. Passenger car motor oils (often labeled "ENERGY CONSERVING II") contain anti-friction additives which will cause clutch and/or starter clutch slippage, resulting in reduced component life and poor engine performance.

Quantity

| | |
|---------------------------|-------|
| Periodic oil change | 1.2 L |
| Total amount (dry engine) | 1.4 L |

Final gear case oil

| | |
|--------------|-----------------------------------|
| Type | Engine oil SAE 10W-30 (API SE) |
| Total amount | 0.25 L |

Radiator capacity (including all routes)

1.4 L

Air filter

Wet type element

Fuel

| | |
|--------------------|-----------------------------------|
| Type | REGULAR UNLEADED GASOLINE ONLY |
| Fuel tank capacity | 12 L |

Carburetor

| | |
|------------------|-------------|
| Manufacturer | TEIKEI |
| Model × quantity | Y28V-1E × 1 |

Spark plug

| | |
|--------------------|------------|
| Manufacturer/model | NGK/DR8EA |
| Spark plug gap | 0.6–0.7 mm |

Clutch type

Dry, centrifugal automatic

Transmission

| | |
|----------------------------|---------------|
| Primary reduction system | Helical gear |
| Primary reduction ratio | 40/15 (2.666) |
| Secondary reduction system | Helical gear |
| Secondary reduction ratio | 38/15 (2.533) |

Transmission type

V-belt automatic

Operation

Centrifugal automatic type

Chassis

| | |
|--------------|----------------------|
| Frame type | Steel tube underbone |
| Caster angle | 28° |
| Trail | 103 mm |

Tires

Front

| | |
|------------------------|-----------------------------|
| Type | Tubeless |
| Size | 110/90-12 64L |
| Manufacturer/ model | IRC/MB67 MICHELIN/BOPPER |

Rear

| | |
|------------------------|-----------------------------|
| Type | Tubeless |
| Size | 130/70-12 62L |
| Manufacturer/ model | IRC/MB67 MICHELIN/BOPPER |

Maximum load*

185 kg

Air pressure (cold tire) up to 90 kg load*

| | |
|-------|---|
| Front | 175 kPa (1.75 kgf/cm ² , 1.75 bar) |
| Rear | 200 kPa (2.00 kgf/cm ² , 2.00 bar) |

SPECIFICATIONS

90 kg load—maximum load*

Front 200 kPa (2.00 kgf/cm², 2.00 bar)

Rear 225 kPa (2.25 kgf/cm², 2.25 bar)

* Total weight of rider, passenger, cargo and accessories

Wheels

Front

Type Cast wheel

Size 12 × MT2.75

Rear

Type Cast wheel

Size 12 × MT3.50

Brakes

Front

Type Single disc brake

Operation Right hand

Fluid DOT 4

Rear

Type Single disc brake

Operation Left hand

Fluid DOT 4

Suspension

Front Telescopic fork

Rear Unit swing

Spring/shock absorbers

Front Coil spring/oil damper

Rear Coil spring/oil damper

Wheel travel

Front 100 mm

Rear 90 mm

Electrical

Ignition system Transistorized coil ignition (digital)

Charging system

Type A.C. magneto

Standard output 14 V, 19.5 A @ 5,000 r/min

Battery

Type GT7B-4

Voltage, capacity 12 V, 6.5 AH

Headlight bulb type

Halogen bulb

Bulb voltage, wattage × quantity

| | |
|-----------------------------|-------------------------------------|
| Headlight | 12 V, 60/55 W × 1 12 V, 55 W × 1 |
| Tail/brake light | 12 V, 5/21 W × 2 |
| Front turn signal light | 12 V, 21 W × 2 |
| Rear turn signal light | 12 V, 18 W × 2 |
| Auxiliary light | 12 V, 5 W × 1 |
| License plate light | 12 V, 5 W × 1 |
| Meter lighting | 12 V, 1.7 W × 4 |
| High beam indicator light | 12 V, 1.7 W × 1 |
| Turn signal indicator light | 12 V, 3.4 W × 2 |
| Oil change indicator light | 12 V, 1.7 W × 1 |

Fuses

| | |
|-----------------------|-------|
| Main fuse | 30 A |
| Headlight fuse | 15 A |
| Signaling system fuse | 15 A |
| Ignition fuse | 7.5 A |
| Radiator fan fuse | 4 A |
| Backup fuse (clock) | 10 A |

SPECIFICATIONS

EAU04513

Conversion table

All specification data in this manual are listed in SI and METRIC UNITS.

Use this table to convert METRIC unit values to IMPERIAL unit values.

Example:

| METRIC VALUE | CONVERSION FACTOR | | IMPERIAL VALUE |
|--------------|-------------------|---|----------------|
| 2 mm | × 0.03937 | = | 0.08 in |

Conversion table

| METRIC SYSTEM TO IMPERIAL SYSTEM | | | |
|----------------------------------|--|---|---|
| | Metric unit | Conversion factor | Imperial unit |
| Torque | m-kgf m-kgf cm-kgf cm-kgf | × 7.233 × 86.794 × 0.0723 × 0.8679 | ft-lbf in-lbf ft-lbf in-lbf |
| Weight | kg g | × 2.205 × 0.03527 | lb oz |
| Speed | km/h | × 0.6214 | mi/h |
| Distance | km m m cm mm | × 0.6214 × 3.281 × 1.094 × 0.3937 × 0.03937 | mi ft yd in in |
| Volume, Capacity | cc (cm ³) cc (cm ³) L (liter) L (liter) | × 0.03527 × 0.06102 × 0.8799 × 0.2199 | oz (IMP liq.) cu-in qt (IMP liq.) gal (IMP liq.) |
| Miscellaneous | kg/mm kgf/cm ² °C | × 55.997 × 14.2234 × 1.8 + 32 | lb/in psi (lb/in ²) °F |

| | |
|-------------------------------------|-----|
| Identification numbers | 9-1 |
| Key identification number | 9-1 |
| Vehicle identification number | 9-1 |
| Model label | 9-2 |

CONSUMER INFORMATION

Identification numbers

EAU02944

Record the key identification number, vehicle identification number and model label information in the spaces provided below for assistance when ordering spare parts from a Yamaha dealer or for reference in case the vehicle is stolen.

1. KEY IDENTIFICATION NUMBER:

2. VEHICLE IDENTIFICATION NUMBER:

3. MODEL LABEL INFORMATION:

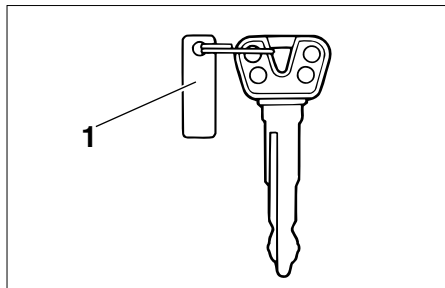

1. Key identification number

EAU01041

Key identification number

The key identification number is stamped into the key tag.

Record this number in the space provided and use it for reference when ordering a new key.

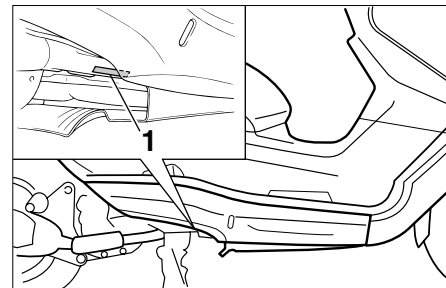

1. Vehicle identification number

EAU01044

Vehicle identification number

The vehicle identification number is stamped into the frame.

NOTE: _____

The vehicle identification number is used to identify your scooter and may be used to register your scooter with the licensing authority in your area.

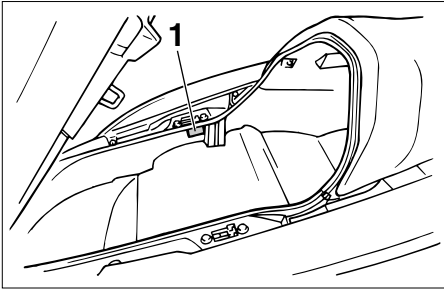

1. Model label

EAU03097

Model label

The model label is affixed to the inside of the rear storage compartment. (See page 3-18 for rear storage compartment opening and closing procedures.) Record the information on this label in the space provided. This information will be needed when ordering spare parts from a Yamaha dealer.

INDEX

A

- Acceleration and deceleration5-3
- Air filter and V-belt case air filter
elements, cleaning6-21
- Air flow louver6-23
- Anti-theft alarm (optional)3-9

B

- Battery6-34
- Battery cover removal6-34
- Brake fluid level, checking6-29
- Brake fluid, changing6-30
- Brake lever, front3-12
- Brake lever, rear3-13
- Brake levers, lubricating6-31
- Braking5-3

C

- Cables, checking and lubricating6-30
- Care7-1
- Catalytic converter3-15
- Centerstand and sidestand, checking
and lubricating6-31
- Conversion table8-5
- Coolant6-19
- Coolant temperature gauge3-5
- Cowlings and panel, removing and
installing6-6

E

- Engine break-in5-4
- Engine oil6-14

F

- Final transmission oil6-18
- Front and rear brake lever free play,
adjusting6-27
- Front fork, checking6-32
- Fuel3-14
- Fuel consumption, tips for reducing5-4
- Fuel gauge3-4
- Fuel tank cap3-13
- Fuses, replacing6-36

H

- Handlebar switches3-10
 - Dimmer switch3-10
 - Engine stop switch3-12
 - Headlight variations3-11
 - Horn switch3-10
 - Pass switch3-10
 - Start switch3-12
 - Turn signal switch3-10
- Headlight bulb, replacing6-37

I

- Identification numbers9-1
- Ignition circuit cut-off system3-21
- Indicator lights3-2
 - High beam indicator light3-2
 - Oil change indicator light3-2
 - Turn signal indicator lights3-2

K

- Key identification number9-1

L

- License plate light bulb, replacing6-41

M

- Main switch/steering lock3-1
- Model label9-2

P

- Parking5-5
- Part locations2-1
- Periodic maintenance and lubrication
chart6-3
- Pre-operation check list4-1

R

- Rider seat3-16
- Rider seat, adjusting3-17

S

- Safe-riding points1-2
- Shock absorber assemblies,
adjusting3-19
- Sidestand3-20
- Spark plug, checking6-12
- Specifications8-1
- Speedometer3-3
- Starting off5-2
- Starting the engine5-1
- Steering, checking6-33
- Storage7-4
- Storage compartments3-17

T

- Tachometer3-3
- Tail/brake light bulb, replacing6-40
- Throttle cable free play, adjusting6-23
- Throttle grip and cable, checking and lubricating6-31
- Tires6-24
- Tool kit6-1
- Troubleshooting6-42
- Troubleshooting charts6-43
- Turn signal light bulb (front), replacing6-39
- Turn signal light bulb (rear), replacing6-40

V

- Valve clearance, adjusting6-23
- Vehicle identification number9-1

W

- Wheel bearings, checking6-33
- Wheels6-26



PRINTED ON RECYCLED PAPER

PRINTED IN JAPAN
2002-1-0.2x1(E) 