



OWNER'S MANUAL

EVENUFX

XC125

5ML-F8199-E2

Welcome to the Yamaha world of motorcycling!

As the owner of the CYGNUS X, you are benefiting from Yamaha's vast experience and newest technology regarding the design and manufacture of high-quality products, which have earned Yamaha a reputation for dependability.

Please take the time to read this manual thoroughly, so as to enjoy all advantages of your CYGNUS X. The owner's manual does not only instruct you in how to operate, inspect and maintain your scooter, but also in how to safeguard yourself and others from trouble and injury.

In addition, the many tips given in this manual will help keep your scooter in the best possible condition. If you have any further questions, do not hesitate to contact your Yamaha dealer.

The Yamaha team wishes you many safe and pleasant rides. So, remember to put safety first!

IMPORTANT MANUAL INFORMATION

EAU10120

Particularly important information is distinguished in this manual by the following notations:

EAU34111



The Safety Alert Symbol means **ATTENTION! BECOME ALERT! YOUR SAFETY IS INVOLVED!**



Failure to follow **WARNING** instructions could result in severe injury or death to the scooter operator, a bystander, or a person inspecting or repairing the scooter.



A **CAUTION** indicates special precautions that must be taken to avoid damage to the scooter.



A **NOTE** provides key information to make procedures easier or clearer.

NOTE:

- This manual should be considered a permanent part of this scooter and should remain with it even if the scooter is subsequently sold.
- Yamaha continually seeks advancements in product design and quality. Therefore, while this manual contains the most current product information available at the time of printing, there may be minor discrepancies between your scooter and this manual. If you have any questions concerning this manual, please consult your Yamaha dealer.



PLEASE READ THIS MANUAL CAREFULLY AND COMPLETELY BEFORE OPERATING THIS SCOOTER.

EWA12410

*Product and specifications are subject to change without notice.

**CYGNUS X
OWNER'S MANUAL
©2005 by Yamaha Motor Taiwan Co., Ltd.
1st edition, September 2005
All rights reserved.
Any reprinting or unauthorized use
without the written permission of
Yamaha Motor Taiwan Co., Ltd.
is expressly prohibited.
Printed in Taiwan.**

TABLE OF CONTENTS

SAFETY INFORMATION 1-1

Further safe-riding points 1-4

DESCRIPTION 2-1

Left view 2-1

Right view 2-2

Controls and instruments 2-3

INSTRUMENT AND CONTROL

FUNCTIONS..... 3-1

Main switch/steering lock 3-1

Indicator lights 3-2

Speedometer unit 3-3

Fuel gauge 3-3

Handlebar switches 3-3

Front brake lever 3-4

Rear brake lever 3-4

Fuel tank cap 3-5

Fuel 3-6

Catalytic converter 3-6

Kickstarter 3-7

Seat 3-7

Helmet holder 3-8

Storage compartment 3-8

Luggage hook 3-9

Sidestand 3-10

Sidestand switch operation
check 3-10

PRE-OPERATION CHECKS. 4-1

Pre-operation check list 4-2

OPERATION AND IMPORTANT

RIDING POINTS 5-1

Starting a cold engine 5-1

Starting off 5-2

Acceleration and
deceleration 5-2

Braking 5-2

Tips for reducing fuel consump-
tion 5-3

Engine break-in 5-3

Parking 5-4

PERIODIC MAINTENANCE

AND MINOR REPAIR 6-1

Owner's tool kit 6-1

Periodic maintenance and
lubrication chart 6-3

Removing and installing
panels 6-6

Checking the spark plug 6-7

Engine oil and oil strainer 6-8

Final transmission oil 6-10

Air filter and V-belt case air filter
elements 6-11

Adjusting the carburetor 6-13

Adjusting the throttle cable free
play 6-14

Valve clearance 6-14

Tires 6-15

Cast wheels 6-17

Checking the front brake lever
free play 6-17

Adjusting the rear brake lever
free play 6-18

Checking the front brake pads
and rear brake shoes 6-18

Checking the front brake fluid
level 6-19

Changing the brake fluid 6-20

Checking and lubricating the
cables 6-20

Checking and lubricating the
throttle grip and cable 6-21

Lubricating the front and rear

TABLE OF CONTENTS

brake levers	6-21
Checking and lubricating the centerstand and sidestand	6-21
Checking the front fork	6-22
Checking the steering	6-22
Checking the wheel bearings	6-23
Battery	6-23
Replacing the fuses	6-25
Replacing a headlight bulb ..	6-26
Replacing the tail/brake light bulb	6-27
Replacing a front turn signal light bulb	6-28
Rear turn signal light bulb ...	6-28
Troubleshooting	6-29
Troubleshooting chart	6-30

SPECIFICATIONS 8-1

CONSUMER INFORMATION 9-1

Identification numbers	9-1
------------------------------	-----

SCOOTER CARE AND STOR-

AGE 7-1

Care	7-1
------------	-----

Storage	7-3
---------------	-----

SAFETY INFORMATION

1

EAU10261

SCOOTERS ARE SINGLE TRACK VEHICLES. THEIR SAFE USE AND OPERATION ARE DEPENDENT UPON THE USE OF PROPER RIDING TECHNIQUES AS WELL AS THE EXPERIENCE OF THE OPERATOR. EVERY OPERATOR SHOULD KNOW THE FOLLOWING REQUIREMENTS BEFORE RIDING THIS SCOOTER.

HE OR SHE SHOULD:

- OBTAIN THOROUGH INSTRUCTIONS FROM A COMPETENT SOURCE ON ALL ASPECTS OF SCOOTER OPERATION.
- OBSERVE THE WARNINGS AND MAINTENANCE REQUIREMENTS IN THE OWNER'S MANUAL.
- OBTAIN QUALIFIED TRAINING IN SAFE AND PROPER RIDING TECHNIQUES.
- OBTAIN PROFESSIONAL TECHNICAL SERVICE AS INDICATED BY THE OWNER'S MANUAL AND/OR WHEN MADE NECESSARY BY MECHANICAL CONDITIONS.

Safe riding

- Always make pre-operation checks. Careful checks may help prevent an accident.
- This scooter is designed to carry the operator and passenger.
- The failure of motorists to detect and recognize scooters in traffic is the predominating cause of automobile/scooter accidents. Many accidents have been caused by an automobile driver who did not see the scooter. Making yourself conspicuous appears to be very effective in reducing the chance of this type of accident.

Therefore:

- Wear a brightly colored jacket.
- Use extra caution when approaching and passing through intersections, since intersections are the most likely places for scooter accidents to occur.
- Ride where other motorists can see you. Avoid riding in another motorist's blind spot.

- Many accidents involve inexperienced operators. In fact, many operators who have been involved in accidents do not even have a current driver's license.
 - Make sure that you are qualified and that you only lend your scooter to other qualified operators.
 - Know your skills and limits. Staying within your limits may help you to avoid an accident.
 - We recommend that you practice riding your scooter where there is no traffic until you have become thoroughly familiar with the scooter and all of its controls.

Many accidents have been caused by error of the scooter operator. A typical error made by the operator is veering wide on a turn due to **EXCESSIVE SPEED** or undercornering (insufficient lean angle for the speed).

- Always obey the speed limit and never travel faster than warranted by road and traffic conditions.

- Always signal before turning or changing lanes. Make sure that other motorists can see you.
- The posture of the operator and passenger is important for proper control.
 - The operator should keep both hands on the handlebar and both feet on the footboard during operation to maintain control of the scooter.
 - The passenger should always hold onto the operator, the seat strap or grab bar, if equipped, with both hands and keep both feet on the passenger foot-rests.
 - Never carry a passenger unless he or she can firmly place both feet on the passenger foot-rests.
- Never ride under the influence of alcohol or other drugs. This scooter is designed for on-road use only. It is not suitable for off-road use.

Protective apparel

The majority of fatalities from scooter accidents are the result of head injuries. The use of a safety helmet is the single most critical factor in the prevention or reduction of head injuries.

- Always wear an approved helmet.
- Wear a face shield or goggles. Wind in your unprotected eyes could contribute to an impairment of vision which could delay seeing a hazard.
- The use of a jacket, substantial shoes, trousers, gloves, etc., is effective in preventing or reducing abrasions or lacerations.
- Never wear loose-fitting clothes, otherwise they could catch on the control levers or wheels and cause injury or an accident.
- Never touch the engine or exhaust system during or after operation. They become very hot and can cause burns. Always wear protective clothing that covers your legs, ankles, and feet.
- Passengers should also observe the above precautions.

Modifications

Modifications made to this scooter not approved by Yamaha, or the removal of original equipment, may render the scooter unsafe for use and may cause severe personal injury. Modifications may also make your scooter illegal to use.

Loading and accessories

Adding accessories or cargo to your scooter can adversely affect stability and handling if the weight distribution of the scooter is changed. To avoid the possibility of an accident, use extreme caution when adding cargo or accessories to your scooter. Use extra care when riding a scooter that has added cargo or accessories. Here are some general guidelines to follow if loading cargo or adding accessories to your scooter:

SAFETY INFORMATION

Loading

The total weight of the operator, passenger, accessories and cargo must not exceed the maximum load limit.

Maximum load:
170 kg (375 lb)

When loading within this weight limit, keep the following in mind:

- Cargo and accessory weight should be kept as low and close to the scooter as possible. Make sure to distribute the weight as evenly as possible on both sides of the scooter to minimize imbalance or instability.
- Shifting weights can create a sudden imbalance. Make sure that accessories and cargo are securely attached to the scooter before riding. Check accessory mounts and cargo restraints frequently.
- Never attach any large or heavy items to the handlebar, front fork, or front fender. Such items can create unstable handling or a slow steering response.

Accessories

Genuine Yamaha accessories have been specifically designed for use on this scooter. Since Yamaha cannot test all other accessories that may be available, you must personally be responsible for the proper selection, installation and use of non-Yamaha accessories. Use extreme caution when selecting and installing any accessories.

Keep the following guidelines in mind, as well as those provided under “Loading” when mounting accessories.

- Never install accessories or carry cargo that would impair the performance of your scooter. Carefully inspect the accessory before using it to make sure that it does not in any way reduce ground clearance or cornering clearance, limit suspension travel, steering travel or control operation, or obscure lights or reflectors.
- Accessories fitted to the handlebar or the front fork area can create instability due to improper weight distribution or aerodynamic changes. If accessories are added to the

handlebar or front fork area, they must be as lightweight as possible and should be kept to a minimum.

- Bulky or large accessories may seriously affect the stability of the scooter due to aerodynamic effects. Wind may attempt to lift the scooter, or the scooter may become unstable in cross winds. These accessories may also cause instability when passing or being passed by large vehicles.
- Certain accessories can displace the operator from his or her normal riding position. This improper position limits the freedom of movement of the operator and may limit control ability, therefore, such accessories are not recommended.
- Use caution when adding electrical accessories. If electrical accessories exceed the capacity of the scooter’s electrical system an electric failure could result, which could cause a dangerous loss of lights or

engine power.

Gasoline and exhaust gas

- **GASOLINE IS HIGHLY FLAMMABLE:**
 - Always turn the engine off when refueling.
 - Take care not to spill any gasoline on the engine or exhaust system when refueling.
 - Never refuel while smoking or in the vicinity of an open flame.
- Never start the engine or let it run for any length of time in a closed area. The exhaust fumes are poisonous and may cause loss of consciousness and death within a short time. Always operate your scooter in an area that has adequate ventilation.
- Always turn the engine off before leaving the scooter unattended and remove the key from the main switch. When parking the scooter, note the following:
 - The engine and exhaust system may be hot, therefore, park the scooter in a place where pedestrians or children

are not likely to touch these hot areas.

- Do not park the scooter on a slope or soft ground, otherwise it may fall over.
- Do not park the scooter near a flammable source (e.g., a kerosene heater, or near an open flame), otherwise it could catch fire.
- If you should swallow any gasoline, inhale a lot of gasoline vapor, or allow gasoline to get into your eyes, see your doctor immediately. If any gasoline spills on your skin or clothing, immediately wash the affected area with soap and water and change your clothes.

Further safe-riding points

- Be sure to signal clearly when making turns.

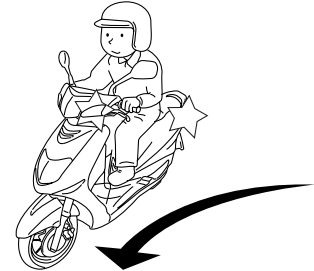

ZALUMOO™

Turn left

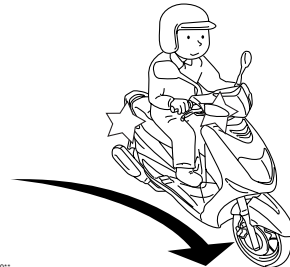

ZALUMOO™

Turn right



SAFETY INFORMATION

1

- Braking can be extremely difficult on a wet road. Avoid hard braking, because the scooter could slide. Apply the brakes slowly when stopping on a wet surface.
- Slow down as you approach a corner or turn. Once you have completed a turn, accelerate slowly.
- Be careful when passing parked cars. A driver might not see you and open a door in your path.
- Railroad crossings, streetcar rails, iron plates on road construction sites, and manhole covers become extremely slippery when wet. Slow down and cross them with caution. Keep the scooter upright, otherwise it could slide out from under you.
- The brake pads could get wet when you wash the scooter. After washing the scooter, check the brakes before riding.
- Always wear a helmet, gloves, trousers (tapered around the cuff and ankle so they do not flap), and a bright colored jacket.
- Do not carry too much luggage on the scooter. An overloaded scooter is unstable.

Left view

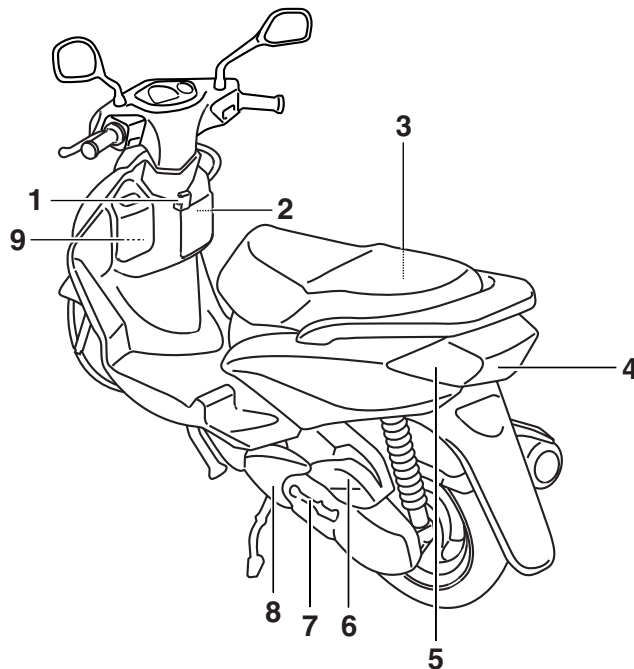
2

1. Luggage hook
2. Battery(Page:6-23)
3. Storage compartment(Page:3-8)
4. Tail/brake light(Page:6-27)
5. Rear turn signal light(Page:6-28)
6. Air filter(Page:6-11)
7. Kickstarter(Page:3-7)
8. V-belt case air filter(Page:6-11)
9. Fuel tank cap(Page:3-5)

Right view

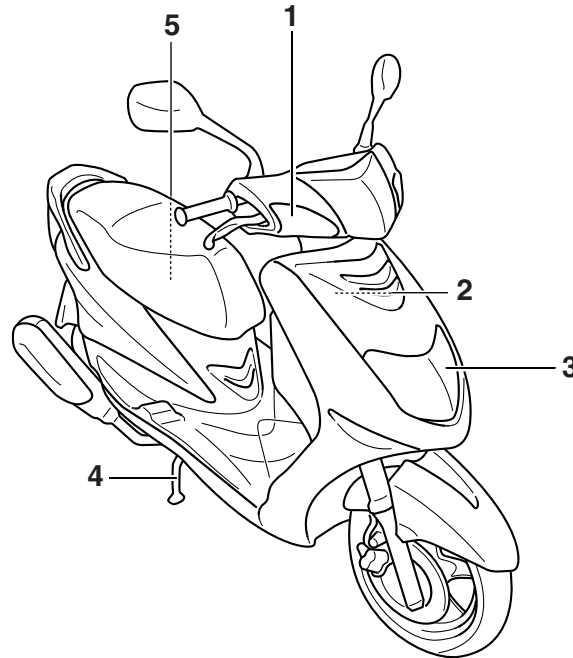

1. Front turn signal light(Page6-28)
2. Main fuse(Page:6-25)
3. Headlight(Page:6-26)
4. Centerstand(Page:6-21)
5. Fuse box(Page:6-25)

DESCRIPTION

EAU10430

Controls and instruments

2

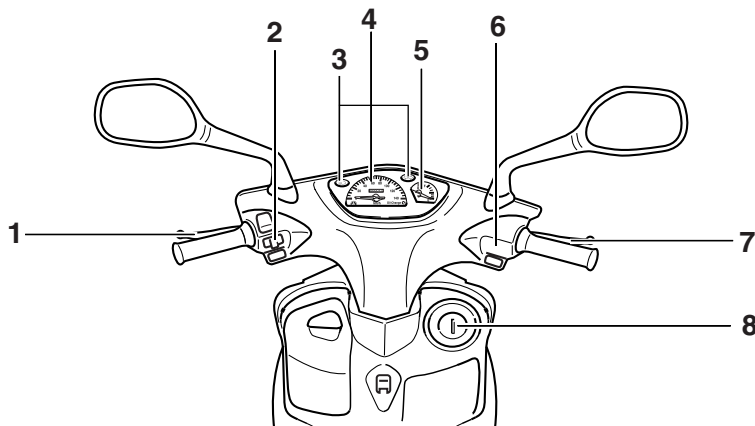

- 1.Rear brake lever (Page3-4)
- 2.Left handlebar switches(Page:3-3)
- 3.Indicator lights(Page:3-2)
- 4.Speedometer unit(Page:3-3)
- 5.Fuel gauge(Page:3-3)
- 6.Right handlebar switches(Page:3-3)
- 7.Front brake lever(Page:3-4)
- 8.Main switch(Page:3-1)

Main switch/steering lock

EAU10460

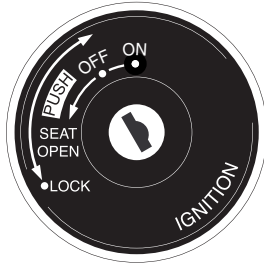

ZAUJ00**

The main switch/steering lock controls the ignition and lighting systems, and is used to lock the steering. The various positions are described below.

ON

EAUT1422

All electrical circuits are supplied with power; the meter lighting, taillight, and auxiliary light come on, and the engine can be started. The key cannot be removed.

NOTE:

The headlights come on automatically when the engine is started and stay on until the key is turned to "OFF" or the sidestand is moved down.

OFF

EAU10660

All electrical systems are off. The key can be removed.

LOCK

EAU10680

The steering is locked, and all electrical systems are off. The key can be removed.

To lock the steering

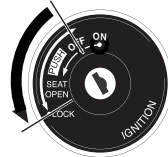

ZAUJ00**

1. Push

1. Turn the handlebars all the way to the left.
2. Push the key in from the "OFF" position, and then turn it to "LOCK" while still pushing it.
3. Remove the key.

To unlock the steering

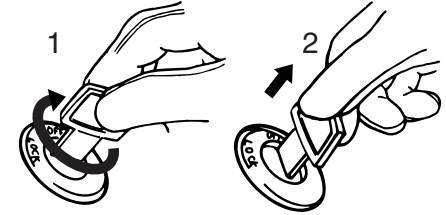

ZAUJ00**

1. Turn
2. Release

Push the key in, and then turn it to "OFF" while still pushing it.

EWA10060

⚠ WARNING

Never turn the key to "OFF" or "LOCK" while the vehicle is moving, otherwise the electrical systems will be switched off, which may result in loss of control or an accident. Make sure that the vehicle is stopped before turning the key to "OFF" or "LOCK".

INSTRUMENT AND CONTROL FUNCTIONS

Indicator lights

EAU10980



After changing the engine oil, reset the oil change indicator switch by pushing it in.

ECA10280

CAUTION:

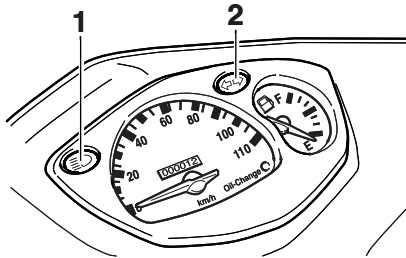
After 1000 km (600 mi) of operation, the engine oil must be changed.



1. High beam indicator light “”
2. Turn signal indicator light “”

Turn signal indicator light “”

EAU11020

This indicator light flashes when the turn signal switch is pushed to the left or right.

High beam indicator light “”

EAU11080

This indicator light comes on when the high beam of the headlight is switched on.

Oil change indicator

EAUT1370

This indicator changes from green to red every 3000 km (1800 mi) to indicate that the engine oil should be changed.

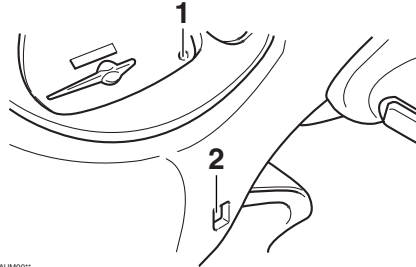

ZALM00**

1. Oil change indicator
2. Reset switch

If the engine oil is changed before the 3000 km (1800 mi) interval, the indicator must be reset after the oil change for the next periodic oil change to be indicated at the correct time.

NOTE:

After resetting the oil change indicator switch, the indicator changes from red to green.

Speedometer unit

EAU11620

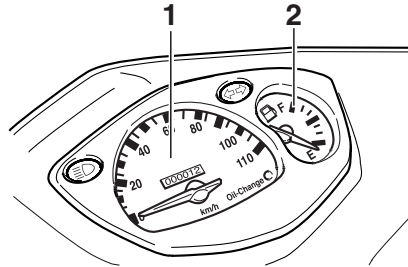

ZALIM00**

1. Speedometer
2. Fuel gauge

The speedometer unit is equipped with a speedometer and an odometer. The speedometer shows riding speed. The odometer shows the total distance traveled.

Fuel gauge

EAU12150

The fuel gauge indicates the amount of fuel in the fuel tank. The needle moves towards "E" (Empty) as the fuel level decreases. When the needle reaches the red line, refuel as soon as possible.

NOTE:

Do not allow the fuel tank to empty itself completely.

Handlebar switches

EAU12343

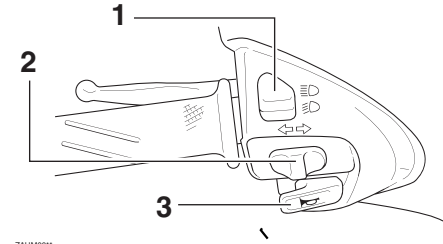

ZALIM00**

1. Dimmer switch "D"
2. Turn signal switch "← →"
3. Horn switch "📢"

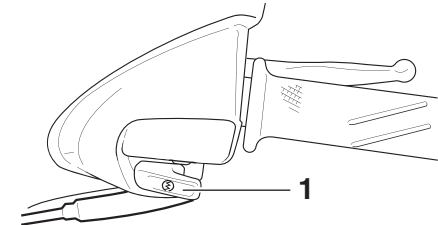



ZALIM00**

1. Start switch "⚡"

INSTRUMENT AND CONTROL FUNCTIONS

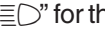

Dimmer switch “ ”

EAU12400

Set this switch to “ ” for the high beam and to “ ” for the low beam.

Turn signal switch “ ”

EAU12460

To signal a right-hand turn, push this switch to “ ”. To signal a left-hand turn, push this switch to “ ”. When released, the switch returns to the center position. To cancel the turn signal lights, push the switch in after it has returned to the center position.

Horn switch “ ”

EAU12500

Press this switch to sound the horn.

Start switch “ ”

EAU12720

With the sidestand up, push this switch while applying the front or rear brake to crank the engine with the starter.

ECA10050

CAUTION: _____

See page 5-1 for starting instructions prior to starting the engine.

Front brake lever

EAU12900

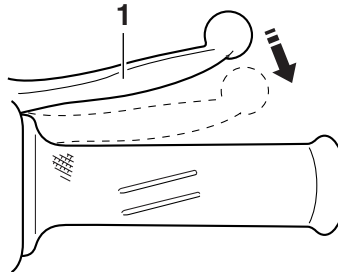

ZAJM00*

1. Front brake lever

The front brake lever is located on the right handlebar grip. To apply the front brake, pull this lever toward the handlebar grip.

Rear brake lever

EAU12950

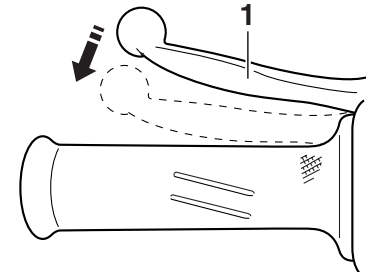

ZAJM00*

1. Rear brake lever

The rear brake lever is located on the left handlebar grip. To apply the rear brake, pull this lever toward the handlebar grip.

EAUT1382

Fuel tank cap

To remove the fuel tank cap

Open the lid by pulling the lever up. Insert the key into the fuel tank cap lock and turn it 1/4 turn counterclockwise. The lock will be released and the fuel tank cap can be removed.

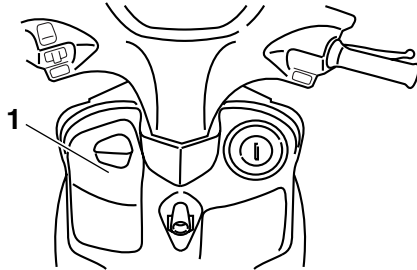

ZALUM00**

1. Lid

NOTE:

After removing the fuel tank cap, place it into the fuel tank cap holder as shown.

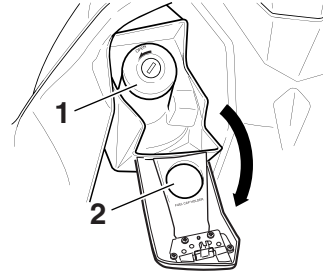

ZALUM00**

1. Fuel tank cap
2. Fuel tank cap holder

To install the fuel tank cap

1. Insert the fuel tank cap into the fuel tank opening with the key inserted in the lock and the match marks aligned.

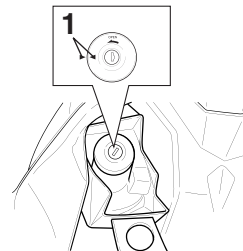

ZALUM00**

1. Match marks

2. Turn the key clockwise to the original position, and then remove it.

NOTE:

The fuel tank cap cannot be installed unless the key is in the lock. In addition, the key cannot be removed if the cap is not properly installed and locked.

3. Close the lid.

EWA10130

WARNING

Make sure that the fuel tank cap is properly installed before riding.

INSTRUMENT AND CONTROL FUNCTIONS

Fuel

EAU13210

deteriorate painted surfaces or plastic parts.

EAU33520

Recommended fuel:
REGULAR UNLEADED GASOLINE ONLY
Fuel tank capacity:
7.1 L (1.88 US gal) (1.56 Imp.gal)

ECA11400

CAUTION:

Use only unleaded gasoline. The use of leaded gasoline will cause severe damage to internal engine parts, such as the valves and piston rings, as well as to the exhaust system.

Your Yamaha engine has been designed to use regular unleaded gasoline with a research octane number of 91 or higher. If knocking (or pinging) occurs, use a gasoline of a different brand or premium unleaded fuel. Use of unleaded fuel will extend spark plug life and reduce maintenance costs.

ECA10070

CAUTION:

Immediately wipe off spilled fuel with a clean, dry, soft cloth, since fuel may

EAU13431

Catalytic converter

This model is equipped with a catalytic converter in the exhaust system.

EWA10860

⚠ WARNING

The exhaust system is hot after operation. Make sure that the exhaust system has cooled down before doing any maintenance work.

ECA10700

CAUTION:

The following precautions must be observed to prevent a fire hazard or other damages.

- Use only unleaded gasoline. The use of leaded gasoline will cause unrepairable damage to the catalytic converter.
- Never park the vehicle near possible fire hazards such as grass or other materials that easily burn.
- Do not allow the engine to idle too long.

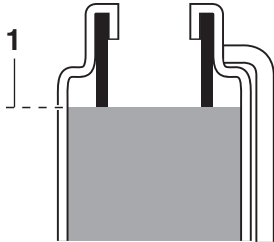

ZALM00**

1. Fuel level

Make sure that there is sufficient fuel in the tank. Fill the fuel tank to the bottom of the filler tube as shown.

EWA10880

⚠ WARNING

- Do not overfill the fuel tank, otherwise it may overflow when the fuel warms up and expands.
- Avoid spilling fuel on the hot engine.

Kickstarter

EAU13680

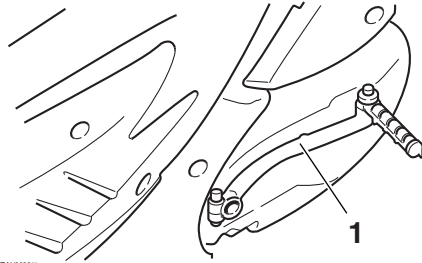

1. Kickstarter

To start the engine, fold out the kickstarter lever, move it down lightly with your foot until the gears engage, and then push it down smoothly but forcefully.

Seat

EAU13931

To open the seat

1. Place the scooter on the centerstand.
2. Insert the key into the main switch, and then turn it counterclockwise.

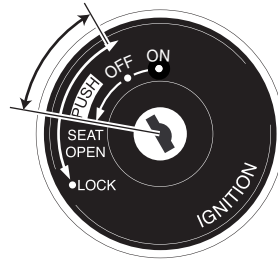

ZAJM00**

NOTE:

Do not push inward when turning the key.

3. Fold the seat up.

To close the seat

1. Fold the seat down, and then push it down to lock it in place.
2. Remove the key from the main switch if the scooter will be left unattended.

NOTE:

Make sure that the seat is properly secured before riding.

INSTRUMENT AND CONTROL FUNCTIONS

Helmet holder

EAU14300

To release the helmet from the helmet holder

Open the seat, remove the helmet from the helmet holder, and then close the seat.

Storage compartment

EAU14510

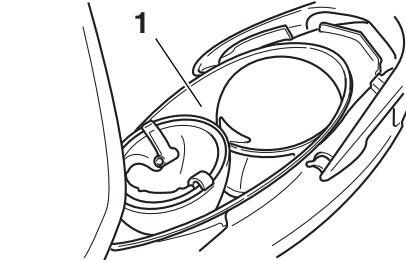

1. Storage compartment

There is a storage compartment under the seat. (See page 3-7.)

EWA10960

⚠ WARNING

- Do not exceed the load limit of 5 kg (11 lb) for the storage compartment.
- Do not exceed the maximum load of 170 kg (375 lb) for the vehicle.

ECA10080

CAUTION:

Keep the following points in mind when using the storage compart-

3

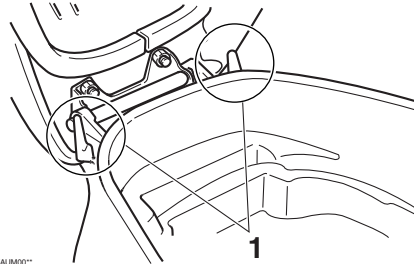

1. Helmet holder

The helmet holder is located under the seat.

To secure a helmet to the helmet holder

1. Open the seat. (See page 3-7.)
2. Attach the helmet to the helmet holder, and then securely close the seat.

EWA10160

⚠ WARNING

Never ride with a helmet attached to the helmet holder, since the helmet may hit objects, causing loss of control and possibly an accident.

ment.

- Since the storage compartment accumulates heat when exposed to the sun, do not store anything susceptible to heat inside it.
- To avoid humidity from spreading through the storage compartment, wrap wet articles in a plastic bag before storing them in the compartment.
- Since the storage compartment may get wet while the scooter is being washed, wrap any articles stored in the compartment in a plastic bag.
- Do not keep anything valuable or breakable in the storage compartment.

To store a helmet in the storage compartment, place the helmet upside-down with the front facing forward.

NOTE:

- Some helmets cannot be stored in the storage compartment because of their size or shape.

- Do not leave your scooter unattended with the seat open.

Luggage hook

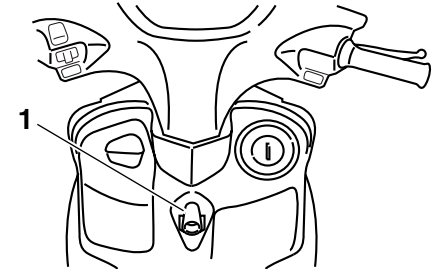

1. Luggage hook

⚠ WARNING

- Do not exceed the load limit of 3 kg (7 lb) for the luggage hook.
- Do not exceed the maximum load of 170 kg (375 lb) for the vehicle.

INSTRUMENT AND CONTROL FUNCTIONS

Sidestand

EAU15301

The sidestand is located on the left side of the frame. Raise the sidestand or lower it with your foot while holding the motorcycle upright.

NOTE:

The built-in sidestand switch is part of the ignition circuit cut-off system, which cuts the ignition in certain situations. (See further down for an explanation of the ignition circuit cut-off system.)

EWA10240

WARNING

The vehicle must not be ridden with the sidestand down, or if the sidestand cannot be properly moved up (or does not stay up), otherwise the sidestand could contact the ground and distract the operator, resulting in a possible loss of control. Yamaha's ignition circuit cut-off system has been designed to assist the operator in fulfilling the responsibility of raising the sidestand before starting off. Therefore, check this system regularly as described below and

have a Yamaha dealer repair it if it does not function properly.

EAUT1091

Sidestand switch operation check

Check the operation of the sidestand switch against the information below.

EWA10260

WARNING

- The vehicle must be placed on the centerstand during this inspection.
 - If a malfunction is noted, have a Yamaha dealer check the system before riding.
-

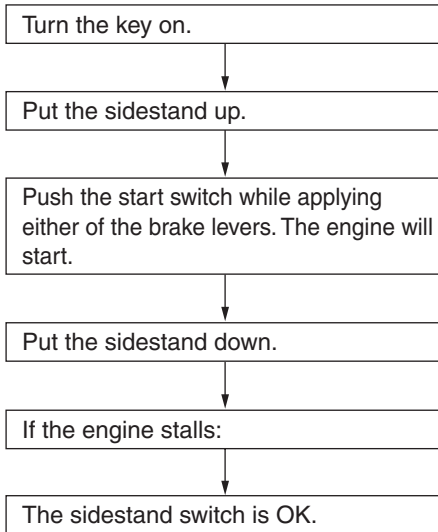

PRE-OPERATION CHECKS

EAU15591

The condition of a vehicle is the owner's responsibility. Vital components can start to deteriorate quickly and unexpectedly, even if the vehicle remains unused (for example, as a result of exposure to the elements). Any damage, fluid leakage or loss of tire air pressure could have serious consequences. Therefore, it is very important, in addition to a thorough visual inspection, to check the following points before each ride.

NOTE:

Pre-operation checks should be made each time the vehicle is used. Such an inspection can be accomplished in a very short time; and the added safety it assures is more than worth the time involved.

EWA11150

⚠ WARNING

4

If any item in the Pre-operation check list is not working properly, have it inspected and repaired before operating the vehicle.

Pre-operation check list

ITEM	CHECKS	PAGE
Fuel	<ul style="list-style-type: none"> • Check fuel level in fuel tank. • Refuel if necessary. • Check fuel line for leakage. 	3-6
Engine oil	<ul style="list-style-type: none"> • Check oil level in engine. • If necessary, add recommended oil to specified level. • Check vehicle for oil leakage. 	6-8
Final transmission oil	<ul style="list-style-type: none"> • Check vehicle for oil leakage. 	6-10
Front brake	<ul style="list-style-type: none"> • Check operation. • If soft or spongy, have Yamaha dealer bleed hydraulic system. • Check brake pads for wear. • Replace if necessary. • Check fluid level in reservoir. • If necessary, add recommended brake fluid to specified level. • Check hydraulic system for leakage. 	6-18, 6-19
Rear brake	<ul style="list-style-type: none"> • Check operation. • Lubricate cable if necessary. • Check lever free play. • Adjust if necessary. 	6-18, 6-19
Throttle grip	<ul style="list-style-type: none"> • Make sure that operation is smooth. • Check cable free play. • If necessary, have Yamaha dealer adjust cable free play and lubricate cable and grip housing. 	6-14, 6-21
Wheels and tires	<ul style="list-style-type: none"> • Check for damage. • Check tire condition and tread depth. • Check air pressure. • Correct if necessary. 	6-15, 6-17
Brake levers	<ul style="list-style-type: none"> • Make sure that operation is smooth. • Lubricate lever pivoting points if necessary. 	6-21

PRE-OPERATION CHECKS

ITEM	CHECKS	PAGE
Centerstand, sidestand	<ul style="list-style-type: none">• Make sure that operation is smooth.• Lubricate pivots if necessary.	6-21
Chassis fasteners	<ul style="list-style-type: none">• Make sure that all nuts, bolts and screws are properly tightened.• Tighten if necessary.	-
Instruments, lights, signals and switches	<ul style="list-style-type: none">• Check operation.• Correct if necessary.	-
Sidestand switch	<ul style="list-style-type: none">• Check operation of ignition circuit cut-off system.• If system is defective, have Yamaha dealer check vehicle.	3-10

EAU15980
EWA10870

EAUT1100

ECA11040

⚠ WARNING

- Become thoroughly familiar with all operating controls and their functions before riding. Consult a Yamaha dealer regarding any control or function that you do not thoroughly understand.
- Never start the engine or operate it in a closed area for any length of time. Exhaust fumes are poisonous, and inhaling them can cause loss of consciousness and death within a short time. Always make sure that there is adequate ventilation.
- For safety, always start the engine with the centerstand down.

Starting a cold engine

ECA10250

CAUTION:

See page 5-3 for engine break-in instructions prior to operating the vehicle for the first time.

1. Turn the key to “ON”.
2. Close the throttle grip completely.
3. Start the engine by pushing the start switch or by kicking the kickstarter, while applying the front or rear brake.

NOTE:

If the engine fails to start by pushing the start switch, release the switch, wait a few seconds, and then try again. Each starting attempt should be as short as possible to preserve the battery. Do not crank the engine more than 5 seconds on any one attempt. If the engine does not start with the starter motor, try using the kickstarter.

CAUTION:

For maximum engine life, never accelerate hard when the engine is cold!

OPERATION AND IMPORTANT RIDING POINTS

Starting off

EAU16760

NOTE:

Before starting off, allow the engine to warm up.

1. While pulling the rear brake lever with your left hand and holding the grab bar with your right hand, push the scooter off the centerstand.
2. Sit astride the seat, and then adjust the rear view mirrors.
3. Switch the turn signal on.
4. Check for oncoming traffic, and then slowly turn the throttle grip (on the right) in order to take off.
5. Switch the turn signal off.

Acceleration and deceleration

EAU16780

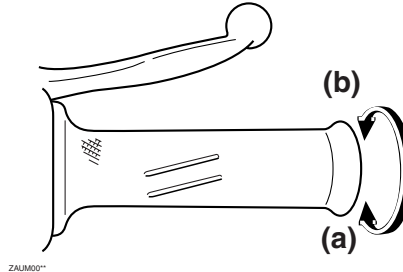

The speed can be adjusted by opening and closing the throttle. To increase the speed, turn the throttle grip in direction (a). To reduce the speed, turn the throttle grip in direction (b).

Braking

EAU16791

1. Close the throttle completely.
2. Apply both front and rear brakes simultaneously while gradually increasing the pressure.

EWA10300

⚠ WARNING

- Avoid braking hard or suddenly (especially when leaning over to one side), otherwise the scooter may skid or overturn.
- Railroad crossings, streetcar rails, iron plates on road construction sites, and manhole covers become extremely slippery when wet. Therefore, slow down when approaching such areas and cross them with caution.
- Keep in mind that braking on a wet road is much more difficult.
- Ride slowly down a hill, as braking downhill can be very difficult.

Tips for reducing fuel consumption

EAU16820

Fuel consumption depends largely on your riding style. Consider the following tips to reduce fuel consumption:

- Avoid high engine speeds during acceleration.
- Avoid high engine speeds with no load on the engine.
- Turn the engine off instead of letting it idle for an extended length of time (e.g., in traffic jams, at traffic lights or at railroad crossings).

Engine break-in

EAU16830

There is never a more important period in the life of your engine than the period between 0 and 1000 km (600 mi). For this reason, you should read the following material carefully.

Since the engine is brand new, do not put an excessive load on it for the first 1000 km (600 mi). The various parts in the engine wear and polish themselves to the correct operating clearances. During this period, prolonged full-throttle operation or any condition that might result in engine overheating must be avoided.

0~150 km (0~90 mi)

EAU16950

Avoid prolonged operation above 1/3 throttle.

After every hour of operation, stop the engine, and then let it cool for five to ten minutes.

Vary the engine speed from time to time. Do not operate the engine at one set throttle position.

150~500 km (90~300 mi)

Avoid prolonged operation above 1/2 throttle.

Rev the engine freely through the gears, but do not use full throttle at any time.

500~1000 km (300~600 mi)

Avoid prolonged operation above 3/4 throttle.

ECA10350

CAUTION: _____

After 1000 km (600 mi) of operation, the engine oil must be changed and the oil strainer cleaned.

1000 km (600 mi) and beyond

Avoid prolonged full-throttle operation. Vary the speed occasionally.

ECA10270

CAUTION: _____

If any engine trouble should occur during the engine break-in period, immediately have a Yamaha dealer check the vehicle.

OPERATION AND IMPORTANT RIDING POINTS

EAU17212

Parking

When parking, stop the engine, and then remove the key from the main switch.

EWA10310

⚠ WARNING

- Since the engine and exhaust system can become very hot, park in a place where pedestrians or children are not likely to touch them.
- Do not park on a slope or on soft ground, otherwise the vehicle may overturn.

5

ECA10380

CAUTION:

Never park in an area where there are fire hazards such as grass or other flammable materials.

Safety is an obligation of the owner. Periodic inspection, adjustment and lubrication will keep your vehicle in the safest and most efficient condition possible. The most important points of inspection, adjustment, and lubrication are explained on the following pages.

The intervals given in the periodic maintenance and lubrication chart should be simply considered as a general guide under normal riding conditions. However, **DEPENDING ON THE WEATHER, TERRAIN, GEOGRAPHICAL LOCATION, AND INDIVIDUAL USE, THE MAINTENANCE INTERVALS MAY NEED TO BE SHORTENED.**

EAU17280

EWA10330

EAU17520

⚠ WARNING

This scooter is designed for use on paved roads only. If this scooter is operated in abnormally dusty, muddy or wet conditions, the air filter element should be cleaned or replaced more frequently, otherwise rapid engine wear may result. Consult a Yamaha dealer for proper maintenance intervals.

⚠ WARNING

If you are not familiar with maintenance work, have a Yamaha dealer do it for you.

EWA10320

Owner's tool kit

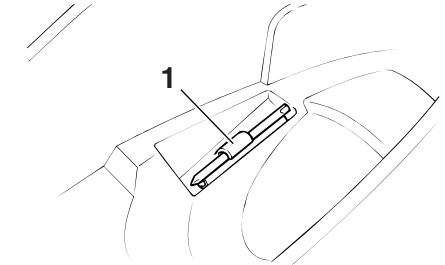

ZAUJ000*

1. Owner's tool kit

The owner's tool kit is located inside the storage compartment under the seat. (See page 3-7.)

The service information included in this manual and the tools provided in the owner's tool kit are intended to assist you in the performance of preventive maintenance and minor repairs. However, additional tools such as a torque wrench may be necessary to perform certain maintenance work correctly.

PERIODIC MAINTENANCE AND MINOR REPAIR

NOTE: _____

If you do not have the tools or experience required for a particular job, have a Yamaha dealer perform it for you.

EWA10350

⚠ WARNING _____

Modifications not approved by Yamaha may cause loss of performance and render the vehicle unsafe for use. Consult a Yamaha dealer before attempting any changes.

PERIODIC MAINTENANCE AND MINOR REPAIR

EAU17710

Periodic maintenance and lubrication chart

NOTE:

- The annual checks must be performed every year, except if a kilometer-based maintenance is performed instead.
- From 30000 km, repeat the maintenance intervals starting from 6000 km.
- Items marked with an asterisk should be performed by a Yamaha dealer as they require special tools, data and technical skills.

NO.	ITEM	CHECK OR MAINTENANCE JOB	ODOMETER READING (× 1,000 km)					ANNUAL CHECK
			1	6	12	18	24	
1	* Fuel line	• Check fuel hoses and vacuum hose for cracks or damage.		√	√	√	√	√
2	Spark plug	• Check condition. • Clean and regap.		√		√		
		• Replace.			√		√	
3	* Valves	• Check valve clearance. • Adjust.		√	√	√	√	
4	Air filter element	• Clean.		√		√		
		• Replace.			√		√	
5	V-belt case air filter element	• Clean.		√	√	√	√	
6	* Front brake	• Check operation, fluid level and vehicle for fluid leakage.	√	√	√	√	√	√
		• Replace brake pads.	Whenever worn to the limit					
7	* Rear brake	• Check operation and adjust brake lever free play.	√	√	√	√	√	√
		• Replace brake shoes.	Whenever worn to the limit					
8	* Brake hose	• Check for cracks or damage.		√	√	√	√	√
		• Replace.	Every 4 years					

PERIODIC MAINTENANCE AND MINOR REPAIR

NO.	ITEM	CHECK OR MAINTENANCE JOB	ODOMETER READING (× 1,000 km)					ANNUAL CHECK
			1	6	12	18	24	
9	* Wheels	• Check runout and for damage.		√	√	√	√	
10	* Tires	• Check tread depth and for damage. • Replace if necessary. • Check air pressure. • Correct if necessary.		√	√	√	√	√
11	* Wheel bearings	• Check bearing for looseness or damage.		√	√	√	√	
12	* Steering bearings	• Check bearing play and steering for roughness. • Lubricate with lithium-soap-based grease.	√	√	√	√	√	
13	* Chassis fasteners	• Make sure that all nuts, bolts and screws are properly tightened.		√	√	√	√	√
14	* Sidestand, centerstand	• Check operation. • Lubricate.		√	√	√	√	√
15	* Sidestand switch	• Check operation.	√	√	√	√	√	√
16	* Front fork	• Check operation and for oil leakage.		√	√	√	√	
17	* Shock absorber assembly	• Check operation and shock absorber for oil leakage.		√	√	√	√	
18	* Carburetor	• Adjust engine idling speed.	√	√	√	√	√	√
19	* Engine oil	• Change. (see page 3-2) • Check oil level and vehicle for oil leakage.	√	Every 3000 km				√
20	* Engine oil strainer	• Clean.	√					
21	* Final transmission oil	• Check vehicle for oil leakage. • Change.	√	√		√		
22	* V-belt	• Replace.	Every 18000 km					
23	* Front and rear brake switches	• Check operation.	√	√	√	√	√	√

PERIODIC MAINTENANCE AND MINOR REPAIR

NO.	ITEM	CHECK OR MAINTENANCE JOB	ODOMETER READING (× 1,000 km)					ANNUAL CHECK
			1	6	12	18	24	
24	Moving parts and cables	• Lubricate.		√	√	√	√	√
25	* Throttle grip housing and cable	• Check operation and free play. • Adjust the throttle cable free play if necessary. • Lubricate the throttle grip housing and cable.		√	√	√	√	√
26	* Air induction system	• Check the air cut-off valve, reed valve, and hose for damage. • Replace the entire air induction system if necessary.		√	√	√	√	√
27	* Lights, signals and switches	• Check operation. • Adjust headlight beam.	√	√	√	√	√	√

EAU18660

NOTE:

- The air filter needs more frequent service if you are riding in unusually wet or dusty areas.
- Hydraulic brake service
 - Regularly check and, if necessary, correct the brake fluid level.
 - Every two years replace the internal components of the brake master cylinder and caliper, and change the brake fluid.
 - Replace the brake hoses every four years and if cracked or damaged.

PERIODIC MAINTENANCE AND MINOR REPAIR

EAU18771

Removing and installing panels

The panels shown above need to be removed to perform some of the maintenance jobs described in this chapter. Refer to this section each time a panel needs to be removed and installed.

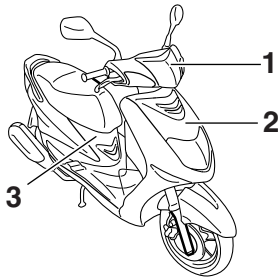

1. Panel A
2. Panel B
3. Panel C

ZAJM00**

EAUT1450

Panel A

To remove the panel

Remove the quick fasteners by pushing in the center pin, and then take the panel off.

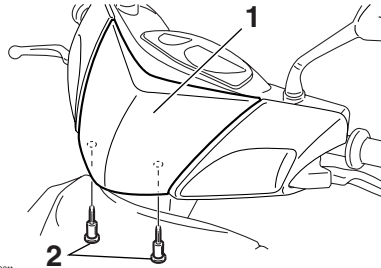

ZAJM00**

1. Panel A
2. Quick fastener

To install the panel

Place the panel in the original position, and then install quick fasteners.

Panel B

To remove the panel

Remove the screws, and then take the panel off.



ZAJM00**

1. Panel B
2. Screw

To install the panel

Place the panel in the original position, and then install the screws.

Panel C

To remove the panel

Remove the screws, and then take the panel off.

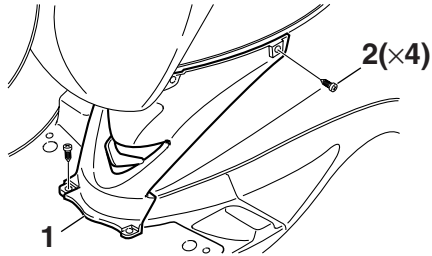

1. Panel C
2. Screw

To install the panel

Place the panel in the original position, and then install the screws.

Checking the spark plug

EAUT1170

The spark plug is an important engine component, which is easy to check. Since heat and deposits will cause any spark plug to slowly erode, the spark plug should be removed and checked in accordance with the periodic maintenance and lubrication chart. In addition, the condition of the spark plug can reveal the condition of the engine.

To remove the spark plug

1. Remove panel C. (See page 6-6.)
2. Remove the spark plug cap.
3. Remove the spark plug as shown, with the spark plug wrench included in the owner's tool kit.

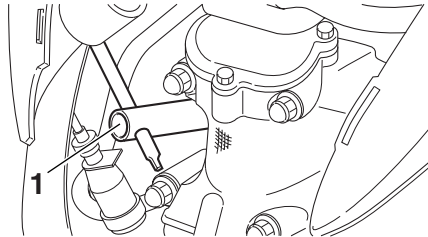

1. Spark plug wrench

To check the spark plug

1. Check that the porcelain insulator around the center electrode of the spark plug is a medium-to-light tan (the ideal color when the vehicle is ridden normally).

NOTE:

If the spark plug shows a distinctly different color, the engine could be defective. Do not attempt to diagnose such problems yourself. Instead, have a Yamaha dealer check the vehicle.

2. Check the spark plug for electrode erosion and excessive carbon or other deposits, and replace it if necessary.

Specified spark plug:
CR7E (NGK)

To install the spark plug

1. Measure the spark plug gap with a wire thickness gauge and, if necessary, adjust the gap to specification.

PERIODIC MAINTENANCE AND MINOR REPAIR

EAUT1350

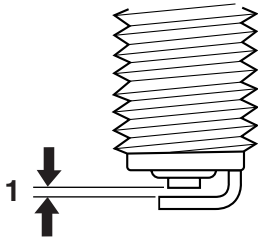

ZAUM00**

1. Spark plug gap

Spark plug gap:

0.6~0.7 mm (0.024~0.028 in)

6

2. Clean the surface of the spark plug gasket and its mating surface, and then wipe off any grime from the spark plug threads.
3. Install the spark plug with the spark plug wrench, and then tighten it to the specified torque.

Tightening torque:

Spark plug:

13 Nm (1.3m • kgf, 9.4ft • lbf)

NOTE:

If a torque wrench is not available when installing a spark plug, a good estimate of the correct torque is 1/4~1/2 turn past finger tight. However, the spark plug should be tightened to the specified torque as soon as possible.

4. Install the spark plug cap.
5. Install the panel.

Engine oil and oil strainer

The engine oil level should be checked before each ride. In addition, the oil must be changed and the oil strainer cleaned at the intervals specified in the periodic maintenance and lubrication chart. The engine oil must also be changed at the initial 1000 km (600 mi) and when the oil change indicator changes from green to red. The oil change indicator must be reset after the initial 1000 km (600 mi). (See page 3-2 for reset procedures.)

To check the engine oil level

1. Place the vehicle on the centerstand.

NOTE:

Make sure that the vehicle is positioned straight up when checking the oil level. A slight tilt to the side can result in a false reading.

2. Start the engine, warm it up for several minutes, and then turn it off.
3. Wait a few minutes until the oil settles, remove the oil filler cap, wipe the dipstick clean, insert it back into the oil filler hole (without

PERIODIC MAINTENANCE AND MINOR REPAIR

screwing it in), and then remove it again to check the oil level.

NOTE: _____
The engine oil should be between the minimum and maximum level marks.

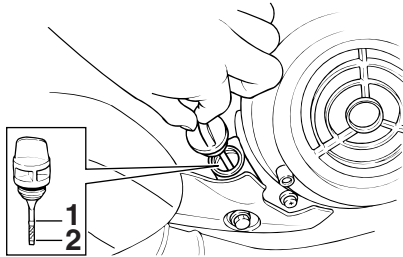

ZALUMOO®

1. Maximum level mark
2. Minimum level mark
3. Remove the dipstick, wipe it clean, and reinsert it.
4. If the engine oil is below the minimum level mark, add sufficient oil of the recommended type to raise it to the correct level.
5. Insert the dipstick into the oil filler hole, and then tighten the oil filler cap.

To change the engine oil and clean the oil strainer

1. Start the engine, warm it up for several minutes, and then turn it off.
2. Place an oil pan under the engine to collect the used oil.
3. Remove the engine oil filler cap and drain bolts to drain the oil from the crankcase.

ECA10410

CAUTION: _____

When removing the engine oil drain bolt, the O-ring, spring, and oil strainer will fall out. Take care not to lose these parts.

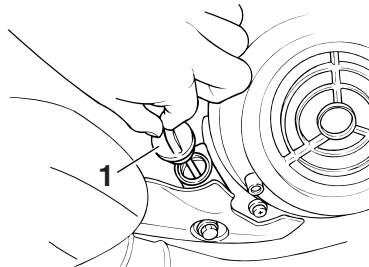

ZALUMOO®

1. Oil filler cap

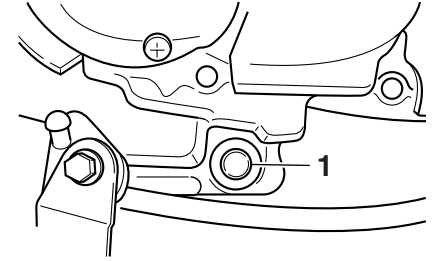

ZALUMOO®

1. Engine oil drain bolt A

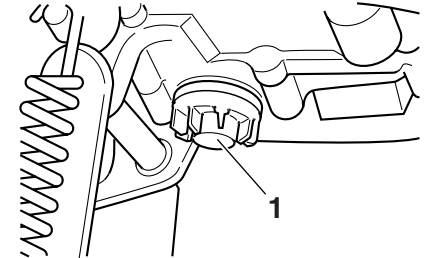

ZALUMOO®

1. Engine oil drain bolt B
2. Remove the O-ring, spring, and oil strainer.
3. Clean the oil strainer with solvent, and then check it for damage and replace it if necessary.
4. Clean the oil strainer with solvent, and then check it for damage and replace it if necessary.
5. Check the O-ring for damage and replace it if necessary.
6. Install the oil strainer, spring, O-ring

PERIODIC MAINTENANCE AND MINOR REPAIR

and engine oil drain bolts, and then tighten the drain bolts to the specified torque.

Tightening torque:

- Engine oil drain bolt A:
20 Nm (2.0 m • kgf, 14.5ft • lbf)
- Engine oil drain bolt B:
20 Nm (2.0 m • kgf, 14.5 ft • lbf)

NOTE:

Make sure that the O-ring is properly seated.

7. Add the specified amount of the recommended engine oil, and then install and tighten the engine oil filler cap.

Recommended engine oil:

- See page 8-1.
- Oil change quantity:
0.9 L (0.95 US qt) (0.79 Imp.qt)

ECA11670

CAUTION:

- Do not use oils with a diesel specification of “CD” or oils of a higher quality than specified. In addition, do not use oils labeled

“ENERGY CONSERVING II” or higher.

- Be sure no foreign material enters the crankcase.

8. Start the engine, and then let it idle for several minutes while checking it for oil leakage. If oil is leaking, immediately turn the engine off and check for the cause.
9. Turn the engine off, and then check the oil level and correct it if necessary.
10. Reset the oil change indicator. (See page 3-2 for reset procedures.)

NOTE:

If the engine oil is changed before the oil change indicator changes to red (i.e. before the periodic oil change interval has been reached), the indicator must be reset after the oil change for the next periodic oil change to be indicated at the correct time.

EAU20060

Final transmission oil

The final transmission case must be checked for oil leakage before each ride. If any leakage is found, have a Yamaha dealer check and repair the scooter. In addition, the final transmission oil must be changed as follows at the intervals specified in the periodic maintenance and lubrication chart.

1. Start the engine, warm it up by riding the scooter for several minutes, and then stop the engine.
2. Place the scooter on the centerstand.
3. Place an oil pan under the final transmission case to collect the used oil.
4. Remove the oil filler cap and drain bolt to drain the oil from the final transmission case.

PERIODIC MAINTENANCE AND MINOR REPAIR

EAUT1341

Air filter and V-belt case air filter elements

The air filter and V-belt case air filter elements should be cleaned at the intervals specified in the periodic maintenance and lubrication chart. Clean both filter elements more frequently if you are riding in unusually wet or dusty areas.

Cleaning the air filter element

1. Place the scooter on the centerstand.
2. Remove the air filter case cover by removing the screws.

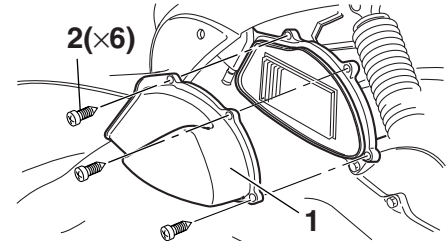

ZALIM00**

1. Air filter case cover
2. Screw

3. Pull the air filter element out, and

Tightening torque:

Final transmission oil drain bolt:
23 Nm (2.3 m • kgf, 16.6 ft • lbf)

6. Add the specified amount of the recommended final transmission oil, and then install and tighten the oil filler cap.

Recommended final transmission oil:

See page 8-1.

Oil quantity:
0.13 L (0.14 US qt) (0.11 Imp.qt)

EWA11310

⚠ WARNING

- Make sure that no foreign material enters the final transmission case.
- Make sure that no oil gets on the tire or wheel.

7. Check the final transmission case for oil leakage. If oil is leaking, check for the cause.

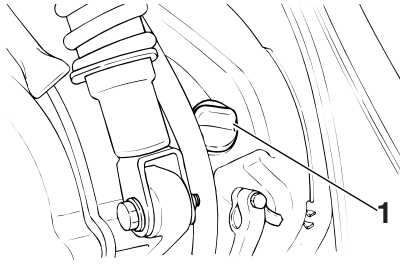

ZALIM00**

1. Final transmission oil filler cap

5. Install the final transmission oil drain bolt, and then tighten it to the specified torque.

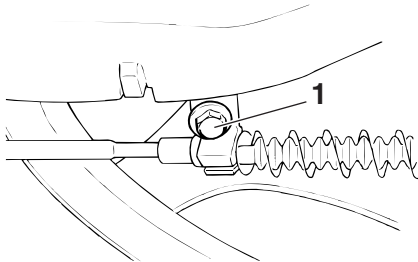

ZALIM00**

1. Final transmission oil drain bolt

PERIODIC MAINTENANCE AND MINOR REPAIR

then blow the dirt out with compressed air as shown.

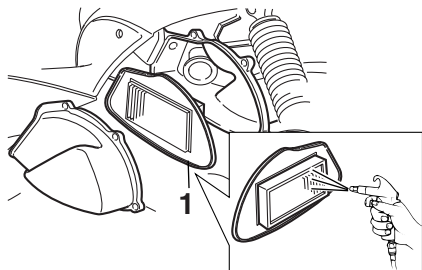

1. Air filter element

4. Check the air filter element for damage and replace it if necessary.
5. Insert the air filter element into the air filter case.

ECA10480

CAUTION:

- Make sure that the air filter element is properly seated in the air filter case.
- The engine should never be operated without the air filter element installed, otherwise the piston(s) and/or cylinder(s) may become excessively worn.

6. Install the air filter case cover by installing the screws.

Cleaning the V-belt case air filter element

1. Remove the V-belt air filter case cover by removing the screws.

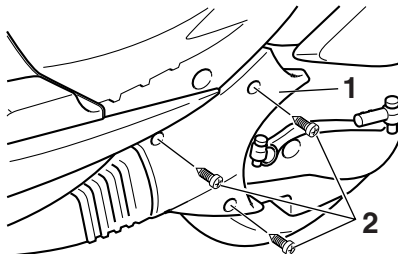

1. Air filter case cover
2. Screw

2. Remove the filter element holder by removing the screw.

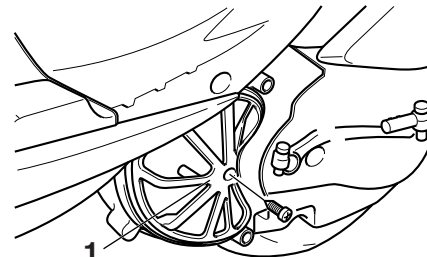

1. Air filter element holder

3. Pull the air filter element out, and then clean it with solvent. After cleaning, remove the remaining solvent by squeezing the element.

EWA10430

WARNING

Use only a dedicated parts cleaning solvent. To avoid the risk of fire or explosion, do not use gasoline or solvents with a low flash point.

ECA10520

CAUTION:

To avoid damaging the air filter element, handle it gently and carefully, and do not twist it.

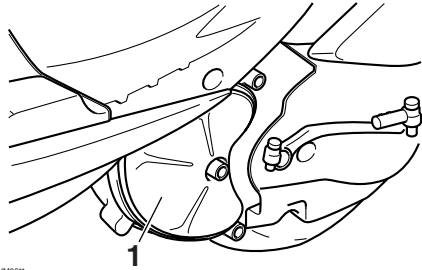

ZALM00**

7. Install the V-belt air filter case cover by installing the screws.

1. V-belt case air filter element

4. Apply oil of the recommended type to the entire surface of the sponge material, and then squeeze the excess oil out.

NOTE: _____
The air filter element should be wet but not dripping.

Recommended oil:
Engine oil

5. Insert the element into the air filter case.
6. Install the filter element holder by installing the screw.

Adjusting the carburetor

The carburetor is an important part of the engine and requires very sophisticated adjustment. Therefore, all carburetor adjustments should be left to a Yamaha dealer, who has the necessary professional knowledge and experience.

PERIODIC MAINTENANCE AND MINOR REPAIR

EAU21370

Adjusting the throttle cable free play

The throttle cable free play should measure 3~5 mm (0.12~0.20 in) at the throttle grip. Periodically check the throttle cable free play and, if necessary, adjust it as follows.

NOTE:

The engine idling speed must be correctly adjusted before checking and adjusting the throttle cable free play.

1. Loosen the locknut.
2. To increase the throttle cable free play, turn the adjusting nut in direction (a). To decrease the throttle cable free play, turn the adjusting nut in direction (b).

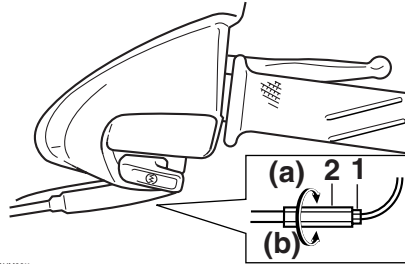

ZALM00**

1. Locknut
1. Adjusting nut
3. Tighten the locknut.

EAU21401

Valve clearance

The valve clearance changes with use, resulting in improper air-fuel mixture and/or engine noise. To prevent this from occurring, the valve clearance must be adjusted by a Yamaha dealer at the intervals specified in the periodic maintenance and lubrication chart.

Tires

EAU33600

To maximize the performance, durability, and safe operation of your vehicle, note the following points regarding the specified tires.

Tire air pressure

The tire air pressure should be checked and, if necessary, adjusted before each ride.

EWA10500

⚠ WARNING

- The tire air pressure must be checked and adjusted on cold tires (i.e., when the temperature of the tires equals the ambient temperature).
- The tire air pressure must be adjusted in accordance with the riding speed and with the total weight of rider, passenger, cargo, and accessories approved for this model.

Tire air pressure (measured on cold tires):

0~90 kg (0~198 lb):

Front:

175 kPa (25 psi) (1.75 kgf/cm²)

Rear:

200 kPa (29 psi) (2.0 kgf/cm²)

90~170 kg (198~375 lb) to maximum load:

Front:

200 kPa (29 psi) (2.0 kgf/cm²)

Rear:

225 kPa (33 psi) (2.25 kgf/cm²)

Maximum load*:

170 kg (375 lb)

* Total weight of rider, passenger, cargo and accessories

EWA11200

⚠ WARNING

Because loading has an enormous impact on the handling, braking, performance and safety characteristics of your vehicle, you should keep the following precautions in mind.

- **NEVER OVERLOAD THE VEHICLE!** Operation of an overloaded motorcycle may result in tire damage, loss of control, or severe injury. Make sure that the total weight of rider, passenger,

cargo, and accessories does not exceed the specified maximum load for the vehicle.

- Do not carry along loosely packed items, which can shift during a ride. Securely pack the heaviest items close to the center of the vehicle and distribute the weight evenly on both sides.
- Adjust the tire air pressure with regard to the load. Check the tire condition and air pressure before each ride.

PERIODIC MAINTENANCE AND MINOR REPAIR

Tire inspection

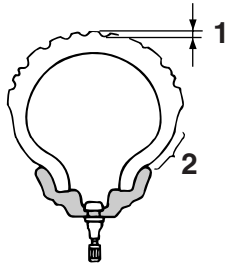

ZALM001*

1. Tire tread depth
2. Tire sidewall

The tires must be checked before each ride. If the center tread depth reaches the specified limit, if the tire has a nail or glass fragments in it, or if the sidewall is cracked, have a Yamaha dealer replace the tire immediately.

Minimum tire tread depth (front and rear):

1.6 mm (0.06 in)

NOTE:

The tire tread depth limits may differ from country to country. Always comply with the local regulations.

Tire information

This model is equipped with tubeless tires.

Front tire:

Size:

110 / 70-12 47L

Manufacturer/model:

CHENG SHIN/C-922N-47L

Rear tire:

Size:

120 / 70-12 58L

Manufacturer/model:

CHENG SHIN/C-6007-58L

EWA10470

⚠ WARNING

- **Have a Yamaha dealer replace excessively worn tires. Besides being illegal, operating the vehicle with excessively worn tires decreases riding stability and can lead to loss of control.**
- **The replacement of all wheel and brake related parts, including the tires, should be left to a Yamaha dealer, who has the necessary professional knowledge and ex-**

perience.

Cast wheels

EAU21960

To maximize the performance, durability, and safe operation of your motorcycle, note the following points regarding the specified wheels.

- The wheel rims should be checked for cracks, bends or warpage before each ride. If any damage is found, have a Yamaha dealer replace the wheel. Do not attempt even the smallest repair to the wheel. A deformed or cracked wheel must be replaced.
- The wheel should be balanced whenever either the tire or wheel has been changed or replaced. An unbalanced wheel can result in poor performance, adverse handling characteristics, and a shortened tire life.
- Ride at moderate speeds after changing a tire since the tire surface must first be “broken in” for it to develop its optimal characteristics.

Checking the front brake lever free play

EAUT1220

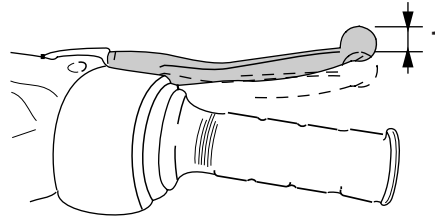

ZALUM0107

1. Brake lever free play

The brake lever free play should measure 3~5 mm (0.12~0.2 in) as shown. Periodically check the brake lever free play and, if necessary, have a Yamaha dealer check the brake system.

EWA10640

⚠ WARNING

An incorrect brake lever free play indicates a hazardous condition in the brake system. Do not operate the motorcycle until the brake system has

been checked or repaired by a Yamaha dealer.

PERIODIC MAINTENANCE AND MINOR REPAIR

EAU22170

Adjusting the rear brake lever free play

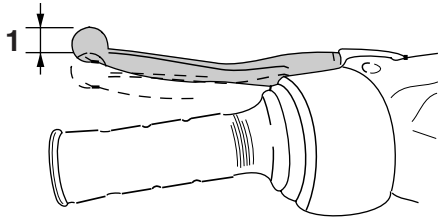

ZALUM108

1. Brake lever free play

6

The brake lever free play should measure 10~20 mm (0.39~0.79 in) as shown. Periodically check the brake lever free play and, if necessary, adjust it as follows.

To increase the brake lever free play, turn the adjusting nut at the brake shoe plate in direction (a). To decrease the brake lever free play, turn the adjusting nut in direction (b).

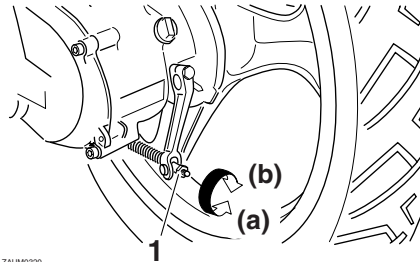

ZALUM020

1. Adjusting nut

EWA10650

⚠ WARNING

If proper adjustment cannot be obtained as described, have a Yamaha dealer make this adjustment.

EAU22380

Checking the front brake pads and rear brake shoes

The front brake pads and the rear brake shoes must be checked for wear at the intervals specified in the periodic maintenance and lubrication chart.

EAU22420

Front brake pads

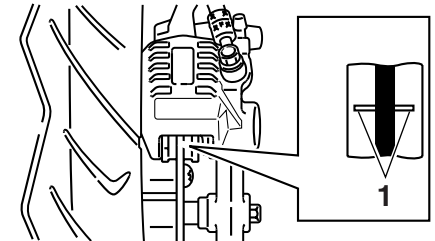

ZALUM001

1. Brake pad wear indicator groove

Each front brake pad is provided with a wear indicator groove, which allows you to check the brake pad wear without having to disassemble the brake. To check the brake pad wear, check the wear indicator groove. If a brake pad has worn to the point that the wear indicator

groove has almost disappeared, have a Yamaha dealer replace the brake pads as a set.

Rear brake shoes

EAU22540

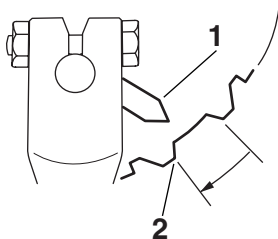

ZALUM0059

1. Wear indicator
2. Wear limit line

The rear brake is provided with a wear indicator, which allows you to check the brake shoe wear without having to disassemble the brake. To check the brake shoe wear, check the position of the wear indicator while applying the brake. If a brake shoe has worn to the point that the wear indicator reaches the wear limit line, have a Yamaha dealer replace the brake shoes as a set.

Checking the front brake fluid level

EAU32343

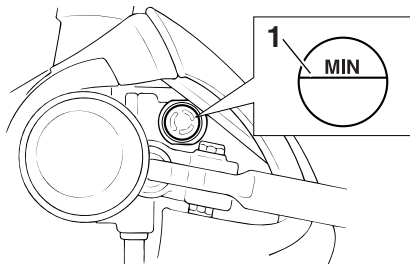

ZALUM00**

1. Minimum level mark

Insufficient brake fluid may allow air to enter the brake system, possibly causing it to become ineffective.

Before riding, check that the brake fluid is above the minimum level mark and replenish if necessary. A low brake fluid level may indicate worn brake pads and/or brake system leakage. If the brake fluid level is low, be sure to check the brake pads for wear and the brake system for leakage.

Observe these precautions:

- When checking the fluid level, make sure that the top of the master cylinder is level by turning the handlebars.
- Use only the recommended quality brake fluid, otherwise the rubber seals may deteriorate, causing leakage and poor braking performance.

Recommended brake fluid:
DOT 4

- Refill with the same type of brake fluid. Mixing fluids may result in a harmful chemical reaction and lead to poor braking performance.
- Be careful that water does not enter the master cylinder when refilling. Water will significantly lower the boiling point of the fluid and may result in vapor lock.
- Brake fluid may deteriorate painted surfaces or plastic parts. Always clean up spilled fluid immediately.

PERIODIC MAINTENANCE AND MINOR REPAIR

- As the brake pads wear, it is normal for the brake fluid level to gradually go down. However, if the brake fluid level goes down suddenly, have a Yamaha dealer check the cause.

Changing the brake fluid

EAU22720

Have a Yamaha dealer change the brake fluid at the intervals specified in the NOTE after the periodic maintenance and lubrication chart. In addition, have the oil seals of the brake master cylinder and caliper as well as the brake hose replaced at the intervals listed below or whenever they are damaged or leaking.

- Oil seals: Replace every two years.
- Brake hose: Replace every four years.

Checking and lubricating the cables

EAU23100

The operation of all control cables and the condition of the cables should be checked before each ride, and the cables and cable ends should be lubricated if necessary. If a cable is damaged or does not move smoothly, have a Yamaha dealer check or replace it.

Recommended lubricant:

Engine oil

EWA10720

⚠ WARNING

Damage to the outer sheath may interfere with proper cable operation and will cause the inner cable to rust. Replace a damaged cable as soon as possible to prevent unsafe conditions.

PERIODIC MAINTENANCE AND MINOR REPAIR

Checking and lubricating the throttle grip and cable

EAU23110

The operation of the throttle grip should be checked before each ride. In addition, the cable should be lubricated or replaced at the intervals specified in the periodic maintenance chart.

Lubricating the front and rear brake levers

EAU23170

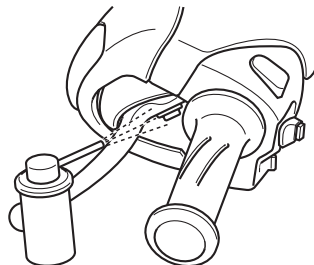

ZAUM00**

The pivoting points of the front and rear brake levers must be lubricated at the intervals specified in the periodic maintenance and lubrication chart.

Recommended lubricant:

Lithium-soap-based grease (all-purpose grease)

Checking and lubricating the centerstand and sidestand

EAU23210

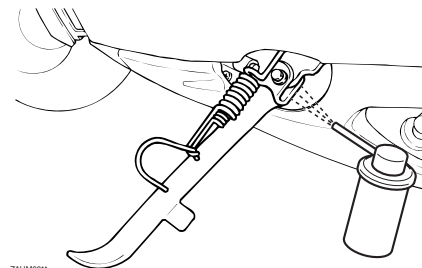

ZAUM00**

The operation of the centerstand and sidestand should be checked before each ride, and the pivots and metal-to-metal contact surfaces should be lubricated if necessary.

EWA10740

⚠ WARNING

If the centerstand or sidestand does not move up and down smoothly, have a Yamaha dealer check or repair it.

Recommended lubricant:

Lithium-soap-based grease (all-purpose grease)

PERIODIC MAINTENANCE AND MINOR REPAIR

EAU23271

Checking the front fork

The condition and operation of the front fork must be checked as follows at the intervals specified in the periodic maintenance and lubrication chart.

To check the condition

EWA10750

⚠ WARNING

Securely support the motorcycle so that there is no danger of it falling over.

Check the inner tubes for scratches, damage and excessive oil leakage.

To check the operation

1. Place the motorcycle on a level surface and hold it in an upright position.
2. While applying the front brake, push down hard on the handlebars several times to check if the front fork compresses and rebounds smoothly.



ZALM00**

ECA10590

CAUTION:

If any damage is found or the front fork does not operate smoothly, have a Yamaha dealer check or repair it.

EAU23280

Checking the steering

Worn or loose steering bearings may cause danger. Therefore, the operation of the steering must be checked as follows at the intervals specified in the periodic maintenance and lubrication chart.

1. Place a stand under the engine to raise the front wheel off the ground.

EWA10750

⚠ WARNING

Securely support the motorcycle so that there is no danger of it falling over.

2. Hold the lower ends of the front fork legs and try to move them forward and backward. If any free play can be felt, have a Yamaha dealer check or repair the steering.

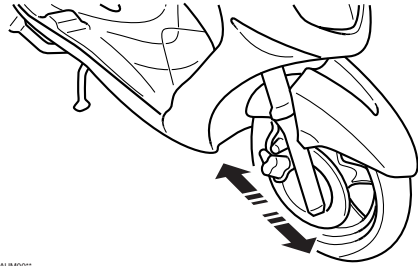

ZALM00**

EAU23290

Checking the wheel bearings

The front and rear wheel bearings must be checked at the intervals specified in the periodic maintenance and lubrication chart. If there is play in the wheel hub or if the wheel does not turn smoothly, have a Yamaha dealer check the wheel bearings.

EAU1401

Battery

This model is equipped with a sealed-type (MF) battery, which does not require any maintenance. There is no need to check the electrolyte or to add distilled water.

ECA10630

CAUTION:

- Always keep the battery charged. Storing a discharged battery can cause permanent battery damage.
- To charge a sealed-type (MF) battery, a special (constant-voltage) battery charger is required. Using a conventional battery charger will damage the battery. If you do not have access to a sealed-type (MF) battery charger, have a Yamaha dealer charge your battery.

6

EWA10760

⚠ WARNING

- Electrolyte is poisonous and dangerous since it contains sulfuric acid, which causes severe burns.

PERIODIC MAINTENANCE AND MINOR REPAIR

Avoid any contact with skin, eyes or clothing and always shield your eyes when working near batteries. In case of contact, administer the following FIRST AID.

- **EXTERNAL:** Flush with plenty of water.
- **INTERNAL:** Drink large quantities of water or milk and immediately call a physician.
- **EYES:** Flush with water for 15 minutes and seek prompt medical attention.
- Batteries produce explosive hydrogen gas. Therefore, keep sparks, flames, cigarettes, etc., away from the battery and provide sufficient ventilation when charging it in an enclosed space.
- **KEEP THIS AND ALL BATTERIES OUT OF THE REACH OF CHILDREN.**

To charge the battery

Have a Yamaha dealer charge the battery as soon as possible if it seems to

have discharged. Keep in mind that the battery tends to discharge more quickly if the vehicle is equipped with optional electrical accessories.

To store the battery

1. If the vehicle will not be used for more than one month, remove the battery, fully charge it, and then place it in a cool, dry place.
2. If the battery will be stored for more than two months, check it at least once a month and fully charge it if necessary.

To remove the battery

1. Remove the panel by removing the screw.

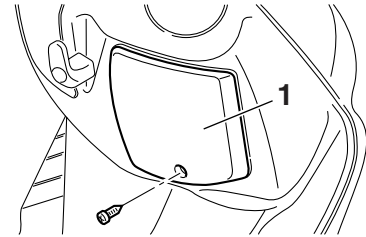

ZAJM00*

1. Panel
2. Remove the battery holder bracket by removing the bolt.

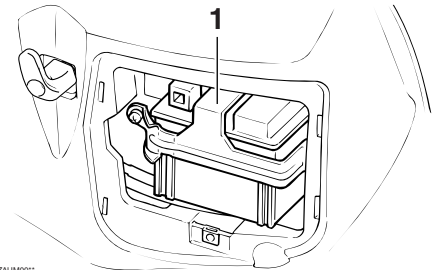

ZAJM00*

1. Bracket
3. Pull the battery out from the battery box, and then disconnect the battery couplers.

EAUT1431

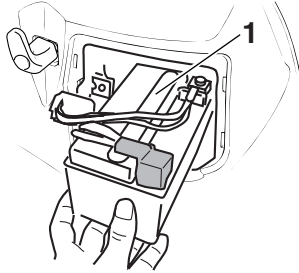

ZALIM00**

1. Battery

To install the battery

1. Connect the battery couplers, and then place the battery in the original position.
2. Install the battery holder bracket by installing the bolt.
3. Install the panel by installing the screw.
4. Fully charge the battery before installation.

Replacing the fuses

The main fuse box is located behind panel B. (See page 6-6.)

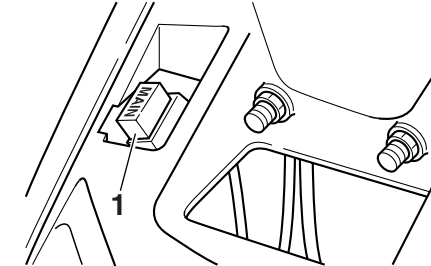

ZALIM00**

1. Main fuse

The fuse block, which contains the fuses for the individual circuits, is located in the storage compartment. (See page 3-8.)

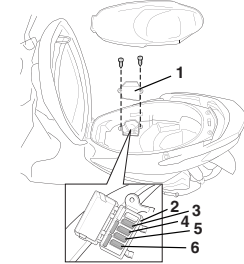

ZALIM00**

1. Lid
2. Fuse box
3. Carburetor heater fuse
4. Ignition fuse
5. Headlight fuse
6. Signaling system fuse

If a fuse is blown, replace it as follows.

1. Turn the key to "OFF" and turn off the electrical circuit in question.
2. Remove the blown fuse, and then install a new fuse of the specified amperage.

PERIODIC MAINTENANCE AND MINOR REPAIR

Specified fuses:

Main fuse:

30 A

Headlight fuse:

15 A

Signaling system fuse:

15 A

Ignition fuse:

7.5 A

Carburetor heater fuse:

7.5 A

ECA10640

CAUTION:

Do not use a fuse of a higher amperage rating than recommended to avoid causing extensive damage to the electrical system and possibly a fire.

6

3. Turn the key to "ON" and turn on the electrical circuit in question to check if the device operates.
4. If the fuse immediately blows again, have a Yamaha dealer check the electrical system.

EAU23710

Replacing a headlight bulb

This model is equipped with quartz bulb headlights. If a headlight bulb burns out, replace it as follows.

1. Place the vehicle on the centerstand.
2. Remove panel B. (See page 6-6.)
3. Disconnect the headlight coupler, and then remove the bulb cover.

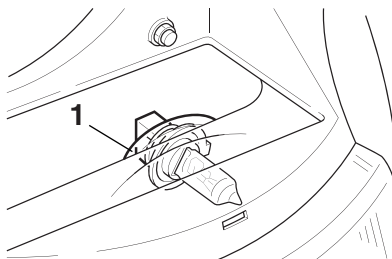

ZAJM00*

1. Bulb cover

4. Unhook the headlight bulb holder, and then remove the defective bulb.

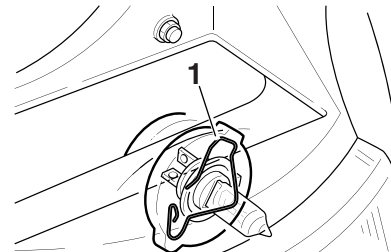

ZAJM00*

1. Headlight bulb holder

EWA10790

WARNING

Headlight bulbs get very hot. Therefore, keep flammable products away from a lit headlight bulb, and do not touch the bulb until it has cooled down.

5. Place a new headlight bulb into position, and then secure it with the bulb holder.

ECA10660

CAUTION:

Do not touch the glass part of the headlight bulb to keep it free from oil, otherwise the transparency of the glass, the luminosity of the bulb, and

the bulb life will be adversely affected. Thoroughly clean off any dirt and fingerprints on the headlight bulb using a cloth moistened with alcohol or thinner.

6. Install the headlight bulb cover, and then connect the coupler.
7. Install the panel.
8. Have a Yamaha dealer adjust the headlight beam if necessary.

EAU24131

Replacing the tail/brake light bulb

1. Remove the tail/brake light lens by removing the screws.
2. Remove the defective bulb by pushing it in and turning it counterclockwise.

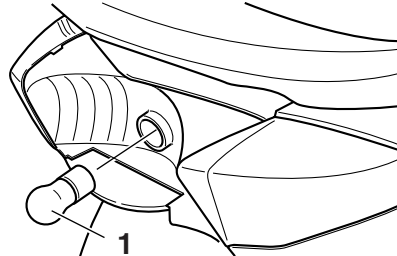

ZALM00**

1. Bulb
3. Insert a new bulb into the socket, push it in, and then turn it clockwise until it stops.
4. Install the lens by installing the screws.

ECA10680

CAUTION:

Do not overtighten the screws, otherwise the lens may break.

PERIODIC MAINTENANCE AND MINOR REPAIR

Replacing a front turn signal light bulb

EAUT1360

ECA10670

CAUTION:

It is advisable to have a Yamaha dealer perform this job.

1. Place the scooter on the centerstand.
2. Remove panel A. (See page 6-6.)
3. Remove the socket (together with the bulb) by turning it counterclockwise.
4. Remove the defective bulb by pushing it in and turning it counterclockwise.

6

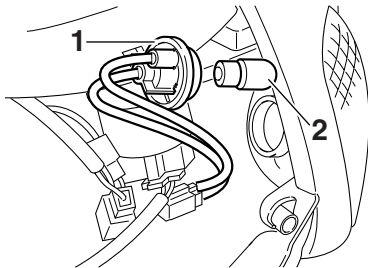

ZALM00**

1. Socket
2. Turn signal light bulb

5. Insert a new bulb into the socket, push it in, and then turn it clockwise until it stops.
6. Install the socket (together with the bulb) by turning it clockwise.
7. Install the panel.

Rear turn signal light bulb

EAUT1330

If a rear turn signal light does not come on, have a Yamaha dealer check the electrical circuit or replace the bulb.

EAU25860

Troubleshooting

Although Yamaha scooters receive a thorough inspection before shipment from the factory, trouble may occur during operation. Any problem in the fuel, compression, or ignition systems, for example, can cause poor starting and loss of power.

The following troubleshooting chart represents a quick and easy procedure for checking these vital systems yourself. However, should your scooter require any repair, take it to a Yamaha dealer, whose skilled technicians have the necessary tools, experience, and know-how to service the scooter properly.

Use only genuine Yamaha replacement parts. Imitation parts may look like Yamaha parts, but they are often inferior, have a shorter service life and can lead to expensive repair bills.

PERIODIC MAINTENANCE AND MINOR REPAIR

EAU25901

Troubleshooting chart

EWA10840

⚠ WARNING

Keep away open flames and do not smoke while checking or working on the fuel system.

1. Fuel

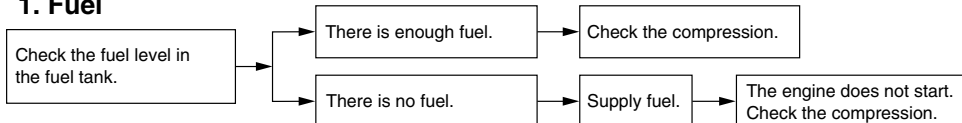

2. Compression

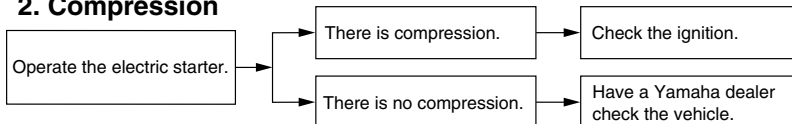

3. Ignition

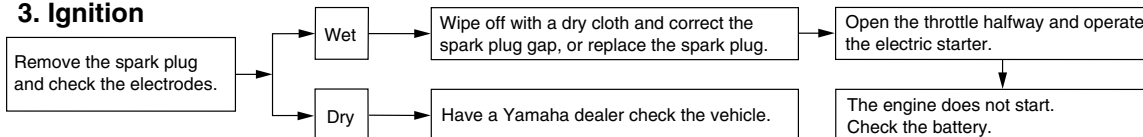

4. Battery

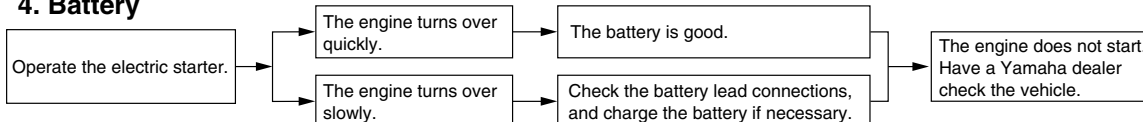

Care

While the open design of a scooter reveals the attractiveness of the technology, it also makes it more vulnerable. Rust and corrosion can develop even if high-quality components are used. A rusty exhaust pipe may go unnoticed on a car, however, it detracts from the overall appearance of a scooter. Frequent and proper care does not only comply with the terms of the warranty, but it will also keep your scooter looking good, extend its life and optimize its performance.

Before cleaning

1. Cover the muffler outlet with a plastic bag after the engine has cooled down.
2. Make sure that all caps and covers as well as all electrical couplers and connectors, including the spark plug cap, are tightly installed.
3. Remove extremely stubborn dirt, like oil burnt onto the crankcase, with a degreasing agent and a brush, but never apply such prod-

EAU26090

ucts onto seals, gaskets and wheel axles. Always rinse the dirt and degreaser off with water.

Cleaning

ECA10780

CAUTION:

- **Avoid using strong acidic wheel cleaners, especially on spoked wheels. If such products are used on hard-to-remove dirt, do not leave the cleaner on the affected area any longer than instructed. Also, thoroughly rinse the area off with water, immediately dry it, and then apply a corrosion protection spray.**
- **Improper cleaning can damage windshields, cowlings, panels and other plastic parts. Use only a soft, clean cloth or sponge with mild detergent and water to clean plastic.**
- **Do not use any harsh chemical products on plastic parts. Be sure to avoid using cloths or sponges which have been in contact with strong or abrasive cleaning prod-**

ucts, solvent or thinner, fuel (gasoline), rust removers or inhibitors, brake fluid, antifreeze or electrolyte.

- **Do not use high-pressure washers or steam-jet cleaners since they cause water seepage and deterioration in the following areas: seals (of wheel and swingarm bearings, fork and brakes), electric components (couplers, connectors, instruments, switches and lights), breather hoses and vents.**
- **For scooters equipped with a windshield: Do not use strong cleaners or hard sponges as they will cause dulling or scratching. Some cleaning compounds for plastic may leave scratches on the windshield. Test the product on a small hidden part of the windshield to make sure that it does not leave any marks. If the windshield is scratched, use a quality plastic polishing compound after washing.**

SCOOTER CARE AND STORAGE

After normal use

Remove dirt with warm water, a mild detergent, and a soft, clean sponge, and then rinse thoroughly with clean water. Use a toothbrush or bottlebrush for hard-to-reach areas. Stubborn dirt and insects will come off more easily if the area is covered with a wet cloth for a few minutes before cleaning.

After riding in the rain, near the sea or on salt-sprayed roads

Since sea salt or salt sprayed on the roads during winter are extremely corrosive in combination with water, carry out the following steps after each ride in the rain, near the sea or on salt-sprayed roads.

NOTE: _____

Salt sprayed on roads in the winter may remain well into spring.

1. Clean the scooter with cold water and a mild detergent after the engine has cooled down.

ECA10790

CAUTION: _____

Do not use warm water since it increases the corrosive action of the salt.

2. Apply a corrosion protection spray on all metal, including chrome- and nickel-plated, surfaces to prevent corrosion.

After cleaning

1. Dry the scooter with a chamois or an absorbing cloth.
2. Use a chrome polish to shine chrome, aluminum and stainless-steel parts, including the exhaust system. (Even the thermally induced discoloring of stainless-steel exhaust systems can be removed through polishing.)
3. To prevent corrosion, it is recommended to apply a corrosion protection spray on all metal, including chrome- and nickel-plated, surfaces.
4. Use spray oil as a universal cleaner to remove any remaining dirt.

5. Touch up minor paint damage caused by stones, etc.
6. Wax all painted surfaces.
7. Let the scooter dry completely before storing or covering it.

EWA10940

⚠ WARNING _____

- **Make sure that there is no oil or wax on the brakes or tires. If necessary, clean the brake discs and brake linings with a regular brake disc cleaner or acetone, and wash the tires with warm water and a mild detergent.**
 - **Before operating the scooter test its braking performance and cornering behavior.**
-

ECA10800

CAUTION: _____

- **Apply spray oil and wax sparingly and make sure to wipe off any excess.**
- **Never apply oil or wax to any rubber and plastic parts, but treat them with a suitable care product.**

- **Avoid using abrasive polishing compounds as they will wear away the paint.**

NOTE: _____
Consult a Yamaha dealer for advice on what products to use.

EAU26300

Storage

Short-term

Always store your scooter in a cool, dry place and, if necessary, protect it against dust with a porous cover.

ECA10820

CAUTION: _____

- **Storing the scooter in a poorly ventilated room or covering it with a tarp, while it is still wet, will allow water and humidity to seep in and cause rust.**
- **To prevent corrosion, avoid damp cellars, stables (because of the presence of ammonia) and areas where strong chemicals are stored.**

Long-term

Before storing your scooter for several months:

1. Follow all the instructions in the “Care” section of this chapter.
2. Drain the carburetor float chamber by loosening the drain bolt; this will prevent fuel deposits from building up. Pour the drained fuel into the fuel tank.

3. Fill up the fuel tank and add fuel stabilizer (if available) to prevent the fuel tank from rusting and the fuel from deteriorating.
4. Perform the following steps to protect the cylinder, piston rings, etc. from corrosion.
 - a. Remove the spark plug cap and spark plug.
 - b. Pour a teaspoonful of engine oil into the spark plug bore.
 - c. Install the spark plug cap onto the spark plug, and then place the spark plug on the cylinder head so that the electrodes are grounded. (This will limit sparking during the next step.)
 - d. Turn the engine over several times with the starter. (This will coat the cylinder wall with oil.)
 - e. Remove the spark plug cap from the spark plug, and then install the spark plug and the spark plug cap.

SCOOTER CARE AND STORAGE

EWA10950

⚠ WARNING

To prevent damage or injury from sparking, make sure to ground the spark plug electrodes while turning the engine over.

°F) or more than 30 °C (90 °F)]. For more information on storing the battery, see page 6-23.

NOTE:

Make any necessary repairs before storing the scooter.

5. Lubricate all control cables and the pivoting points of all levers and pedals as well as of the sidestand/centerstand.
6. Check and, if necessary, correct the tire air pressure, and then lift the scooter so that both of its wheels are off the ground. Alternatively, turn the wheels a little every month in order to prevent the tires from becoming degraded in one spot.
7. Cover the muffler outlet with a plastic bag to prevent moisture from entering it.
8. Remove the battery and fully charge it. Store it in a cool, dry place and charge it once a month. Do not store the battery in an excessively cold or warm place [less than 0 °C (30

Dimensions

Overall length	1855 mm (73.0 in)
Overall width	685 mm (27.0 in)
Overall height	1110 mm (43.7 in)
Seat height	770 mm (30.3 in)
Wheelbase	1295 mm (51.0 in)
Ground clearance	110 mm (4.33 in)
Minimum turning radius	1900 mm (74.8 in)

Weight

With oil and fuel	121.0 kg (267 lb)
-------------------	-------------------

Engine

Engine type	Forced air cooled 4-stroke, SOHC
Cylinder arrangement	Forward-inclined single cylinder
Displacement	124.0 cm ³ (7.57 cu.in)
Bore x stroke	52.4 x 57.9 mm (2.06 x 2.28 in)
Compression ratio	10.00 :1
Starting system	Electric starter and kickstarter
Lubrication system	Wet sump

Engine oil

Type	SAE10W30 or SAE10W40 or SAE15W40 or SAE20W40 or SAE20W50
Recommended engine oil grade	API service SE, SF, SG type or higher

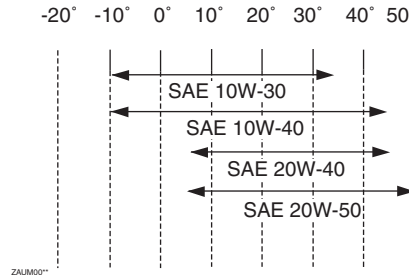

Engine oil quantity	Without oil filter element removal
	0.90 L (0.95 US qt) (0.79 Imp.qt)

Final transmission oil

Type	SAE10W30 type SE motor oil
Quantity	0.11 L (0.12 US qt) (0.10 Imp.qt)

Air filter

Air filter element	Oil-coated paper element
--------------------	--------------------------

Fuel

Recommended fuel	Regular unleaded gasoline only
Fuel tank capacity	7.1 L (1.88 US gal) (1.56 Imp.gal)

Carburetor

Manufacturer	TAIWAN KEIHN
Type x quantity	CVK24 x 1

Spark plug (s)

Manufacturer/model	NGK/CR7E
Spark plug gap	0.6-0.7 mm (0.024-0.028 in)

Clutch

Clutch type	Dry, centrifugal automatic
-------------	----------------------------

Transmission

Primary reduction system	Helical gear
Primary reduction ratio	38/13 (2.923)
Secondary reduction system	Helical gear
Secondary reduction ratio	40/12 (3.333)
Transmission type	V-belt automatic
Operation	Centrifugal automatic type

Chassis

Frame type	Steel tube backbone
Caster angle	27.00°
Trail	90.0 mm (3.54 in)

SPECIFICATIONS

Front tire

- Type
 - Tubeless
- Size
 - 110/70-12 47L
- Manufacturer/model
 - CHENG SHIN/C-922N-47L

Rear tire

- Type
 - Tubeless
- Size
 - 120/70-12 58L
- Manufacturer/model
 - CHENG SHIN/C-6007-58L

Loading

- Maximum load
 - 170 kg (375 lb)

Tire air pressure (measured on cold tires)

- Loading condition
 - 0-90 kg (0-198 lb)
- Front
 - 175 kPa (25 psi) (1.75 kgf/cm²)
- Rear
 - 200 kPa (29 psi) (2.00 kgf/cm²)
- Loading condition
 - 90-170 kg (198-375 lb)
- Front
 - 200 kPa (29 psi) (2.00 kgf/cm²)
- Rear
 - 225 kPa (33 psi) (2.25 kgf/cm²)

Front wheel

- Wheel type
 - Cast wheel
- Rim size
 - 12 x MT2.75

Rear wheel

- Wheel type
 - Cast wheel
- Rim size
 - 12 x MT3.00

Front brake

- Type
 - Single disc brake
- Operation
 - Right hand operation
- Recommended fluid
 - DOT 4

Rear brake

- Type
 - Drum brake
- Operation
 - Left hand operation

Front suspension

- Type
 - Telescopic fork
- Spring/shock absorber type
 - Coil spring/oil damper
- Wheel travel
 - 90.0 mm (3.54 in)

Rear suspension

- Type
 - Unit swing
- Spring/shock absorber type
 - Coil spring/oil damper
- Wheel travel
 - 95.0 mm (3.74 in)

Electrical system

- Ignition system
 - CDI
- Charging system
 - AC magneto

Battery

- Type
 - YTX7A-BS
- Voltage, capacity
 - 12 V, 6.0 Ah

Headlight

- Bulb type
 - Halogen bulb

Bulb voltage, wattage x quantity

- Headlight
 - 12 V, 60 W/55.0 W x 1
- Tail/brake light
 - 12 V, 5.0 W/21.0 W x 1
- Front turn signal light
 - 12 V, 10.0 W x 2
- Rear turn signal light
 - 12 V, 16.0 W x 2
- Auxiliary light
 - 12 V, 5.0 W x 1
- Meter lighting
 - 12 V, 1.7 W x 3
- High beam indicator light
 - 12 V, 1.7 W x 1
- Turn signal indicator light
 - 12 V, 3.4 W x 1

Fuses

Main fuse

30.0 A

Headlight fuse

15.0 A

Signaling system fuse

15.0 A

Ignition fuse

7.5 A

Carburetor heater fuse

7.5 A

CONSUMER INFORMATION

EAU26351

Identification numbers

Record the key identification number, vehicle identification number and model label information in the spaces provided below for assistance when ordering spare parts from a Yamaha dealer or for reference in case the vehicle is stolen.

KEY IDENTIFICATION NUMBER:

VEHICLE IDENTIFICATION NUMBER:

MODEL LABEL INFORMATION:

Key identification number

EAU26381

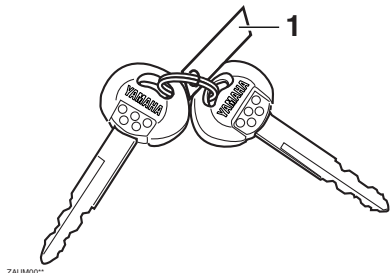

1. Key identification number

The key identification number is stamped into the key tag. Record this number in the space provided and use it for reference when ordering a new key.

Vehicle identification number

EAU26410

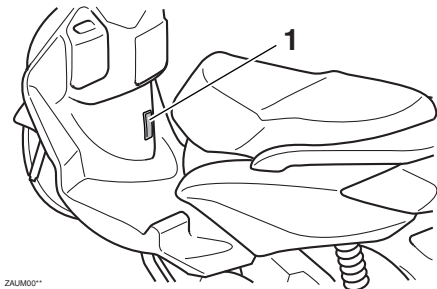

1. Vehicle identification number

The vehicle identification number is stamped into the frame.

NOTE:

The vehicle identification number is used to identify your motorcycle and may be used to register your motorcycle with the licensing authority in your area.

EAUT1440

Model label

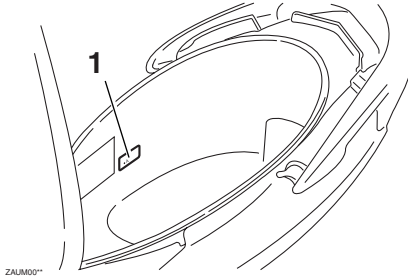

1. Model label

The model label is affixed to the inside of the storage compartment. (See page 3-8.) Record the information on this label in the space provided. This information will be needed when ordering spare parts from a Yamaha dealer.

INDEX

A

- Acceleration and deceleration 5-2
- Air filter and V-belt case air filter elements 6-11

B

- Battery 6-23
- Brake fluid level, checking 6-19
- Brake fluid, changing 6-20
- Brake lever, front 3-4
- Brake lever, rear 3-4
- Brake levers, lubricating 6-21
- Brake pads and shoes, checking 6-18
- Braking 5-2

C

- Cables, checking and lubricating 6-20
- Carburetor, adjusting 6-13
- Catalytic converter 3-6
- Centerstand and sidestand, checking and lubricating 6-21

D

- Dimmer switch 3-4

E

- Engine break-in 5-3
- Engine oil and oil strainer 6-8

F

- Final transmission oil 6-10
- Front brake lever free play, checking 6-17
- Fuel 3-6
- Fuel consumption, tips for reducing 5-3
- Fuel gauge 3-3
- Fuel tank cap 3-5
- Fuses, replacing 6-25

H

- Handlebar switches 3-3
- Headlight bulb, replacing 6-26
- Helmet holder 3-8
- High beam indicator light 3-2
- Horn switch 3-4

I

- Identification numbers 9-1
- Indicator lights 3-2

K

- Key identification number 9-1
- Kickstarter 3-7

L

- Luggage hook 3-9

M

- Main switch/steering lock 3-1
- Model label 9-2

P

- Panels, removing and installing 6-6
- Parking 5-4
- Part locations 2-1
- Periodic maintenance and lubrication chart 6-3
- Pre-operation check list 4-2
- Rear brake lever free play, adjusting 6-18

S

- Safe-riding points 1-4
- Safety information 1-1
- Seat 3-7
- Sidestand 3-10
- Sidestand switch operation check 3-10

- Spark plug, checking 6-7
- Specifications 8-1
- Speedometer unit 3-3
- Start switch 3-4
- Starting a cold engine 5-1
- Starting off 5-2
- Storage 7-3
- Storage compartment 3-8

T

- Tail/brake light bulb, replacing 6-27
- Throttle cable free play, adjusting 6-14
- Throttle grip and cable, checking and lubricating 6-21
- Tires 6-15
- Tool kit 6-1
- Troubleshooting 6-29
- Troubleshooting chart 6-30
- Turn signal indicator light 3-2
- Turn signal light bulb (front), replacing 6-28
- Turn signal switch 3-4

V

- Valve clearance 6-14
- Vehicle identification number 9-1

W

- Wheel bearings, checking 6-23
- Wheels 6-17



PRINTED IN TAIWAN
2005 · 9—0.3×1 
(E)