



OWNER'S MANUAL

***TEO's***

**XN125**

**5MF-F8199-E0**

Welcome to the Yamaha world of motorcycling!

As the owner of a XN125, you are benefiting from Yamaha's vast experience and newest technology regarding the design and manufacture of high-quality products, which have earned Yamaha a reputation for dependability.

Please take the time to read this manual thoroughly, so as to enjoy all advantages of your XN125. The owner's manual does not only instruct you in how to operate, inspect and maintain your scooter, but also in how to safeguard yourself and others from trouble and injury.

In addition, the many tips given in this manual will help keep your scooter in the best possible condition. If you have any further questions, do not hesitate to contact your Yamaha dealer.

The Yamaha team wishes you many safe and pleasant rides. So, remember to put safety first!

# IMPORTANT MANUAL INFORMATION

---

---

Particularly important information is distinguished in this manual by the following notations:



The Safety Alert Symbol means ATTENTION! BECOME ALERT! YOUR SAFETY IS INVOLVED!

## **WARNING**

Failure to follow WARNING instructions could result in severe injury or death to the scooter operator, a bystander, or a person inspecting or repairing the scooter.

## **CAUTION:**

A CAUTION indicates special precautions that must be taken to avoid damage to the scooter.

## **NOTE:**

A NOTE provides key information to make procedures easier or clearer.

## **NOTE:**

- This manual should be considered a permanent part of this scooter and should remain with it even if the scooter is subsequently sold.
  - Yamaha continually seeks advancements in product design and quality. Therefore, while this manual contains the most current product information available at the time of printing, there may be minor discrepancies between your scooter and this manual. If you have any questions concerning this manual, please consult your Yamaha dealer.
-

# IMPORTANT MANUAL INFORMATION

---

---

EW000002

## **⚠ WARNING**

**PLEASE READ THIS MANUAL CAREFULLY AND COMPLETELY BEFORE OPERATING THIS SCOOTER.**

---

---

---

EAUM0023

**XN125  
OWNER'S MANUAL  
© 2000 by MBK INDUSTRIE  
1st Edition, April 2000  
All rights reserved  
Any reproduction or representation  
without the written permission of  
MBK INDUSTRIE  
is expressly prohibited.  
Printed in France.**

# TABLE OF CONTENTS

---

---

1	GIVE SAFETY THE RIGHT OF WAY	1
2	DESCRIPTION	2
3	INSTRUMENT AND CONTROL FUNCTIONS	3
4	PRE-OPERATION CHECKS	4
5	OPERATION AND IMPORTANT RIDING POINTS	5
6	PERIODIC MAINTENANCE AND MINOR REPAIR	6
7	SCOOTER CARE AND STORAGE	7
8	SPECIFICATIONS	8
9	CONSUMER INFORMATION	9
	INDEX	





# GIVE SAFETY THE RIGHT OF WAY

---

---

Give safety the right of way .....	1-1
Further safe-riding points .....	1-2





# GIVE SAFETY THE RIGHT OF WAY

---

---

1

Scooters are fascinating vehicles, which can give you an unsurpassed feeling of power and freedom. However, they also impose certain limits, which you must accept; even the best scooter does not ignore the laws of physics.

Regular care and maintenance are essential for preserving value and operating condition of your scooter. Moreover, what is true for the scooter is also true for the rider: good performance depends on being in good shape. Riding under the influence of medication, drugs and alcohol is, of course, out of the question. Scooter riders-more than car drivers-must always be at their mental and physical best. Under the influence of even small amounts of alcohol, there is a tendency to take dangerous risks.

Protective clothing is as essential for the scooter rider as seat belts are for car drivers and passengers. Always wear a complete scooter suit (whether made of leather or tear-resistant synthetic materials with protectors), sturdy boots, scooter gloves and a properly fitting helmet. Optimum protective wear, however, should not encourage carelessness. Although full-coverage helmets and suits, in particular, create an illusion of total safety and protection, motorcyclists will always be vulnerable. Riders who lack critical self-control run the risk of going too fast and are apt to take chances. This is even more dangerous in wet weather. The good motorcyclist rides safely, predictably and defensively-avoiding all dangers, including those caused by others.

Enjoy your ride!

## Further safe-riding points

**1**

- Be sure to signal clearly when making turns.
- Braking can be extremely difficult on a wet road. Avoid hard braking, because the scooter could slide. Apply the brakes slowly when stopping on a wet surface.
- Slow down as you approach a corner or turn. Once you have completed a turn, accelerate slowly.
- Be careful when passing parked cars. A driver might not see you and open a door in your path.
- Railroad crossings, streetcar rails, iron plates on road construction sites, and manhole covers become extremely slippery when wet. Slow down and cross them with caution. Keep the scooter upright, otherwise it could slide out from under you.
- The brake lining could get wet when you wash the scooter. After washing the scooter, check the brakes before riding.
- Always wear a helmet, gloves, trousers (tapered around the cuff and ankle so they do not flap), and a bright colored jacket.
- Do not carry too much luggage on the scooter. An overloaded scooter is unstable. Use a strong cord to secure any luggage to the carrier. A loose load will affect the stability of the scooter and could divert your attention from the road.



Left view .....	2-1
Right view .....	2-2
Controls and instruments .....	2-3

# DESCRIPTION

## Left view

2

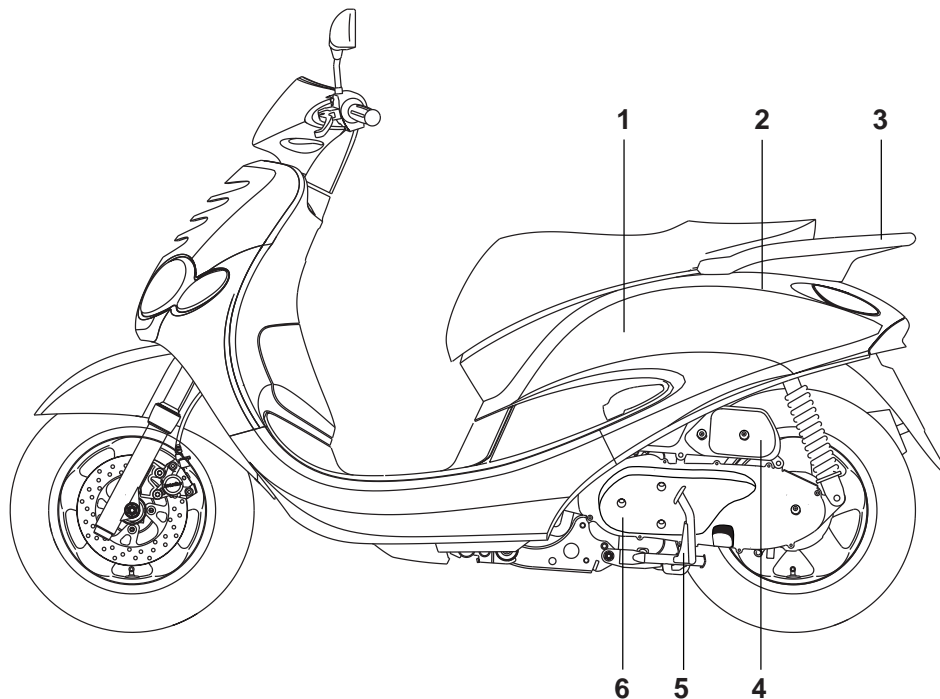

1. Storage compartment (page 3-9)
2. Fuel tank cap (page 3-7)
3. Passenger handle (page 5-2)

4. Air filter (page 6-15)
5. Centerstand (page 6-23)
6. V-belt case air filter (page 6-15)

## Right view

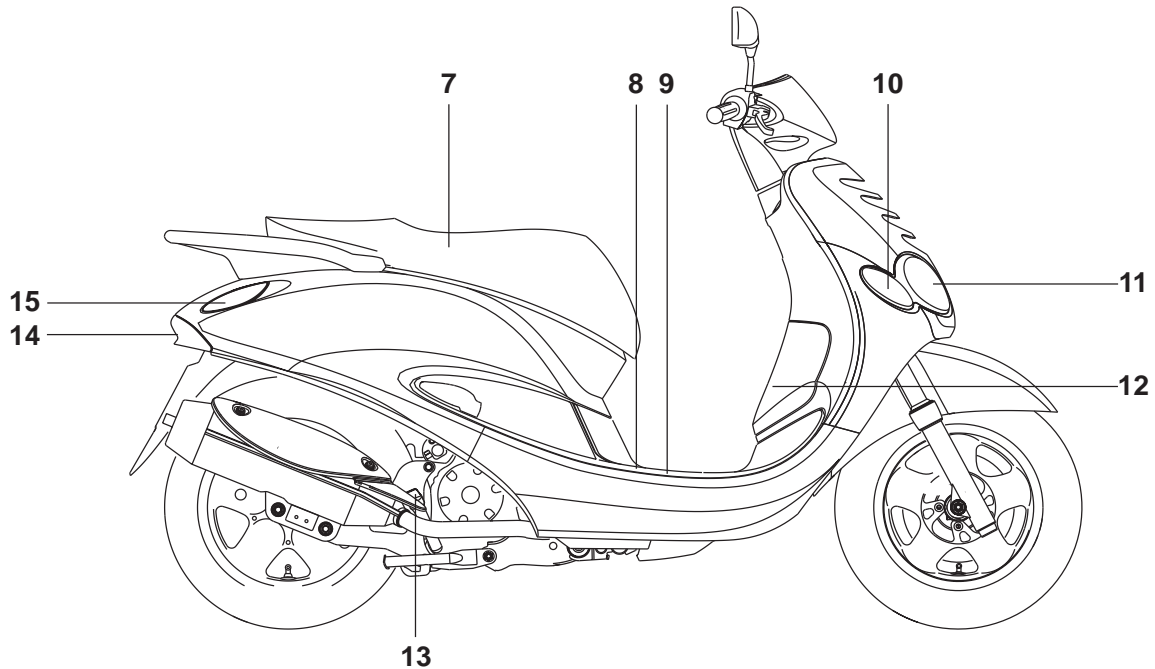

- 7. Seat (page 3-9)
- 8. Battery (page 6-25)
- 9. Fuse (page 6-26)
- 10. Front turn signal (page 6-28)
- 11. Headlight (page 6-28)

- 12. Coolant reservoir (page 6-13)
- 13. Engine oil dipstick (page 6-10)
- 14. Headlight (page 6-29)
- 15. Rear turn signal (page 6-28)

# DESCRIPTION

## Controls and instruments

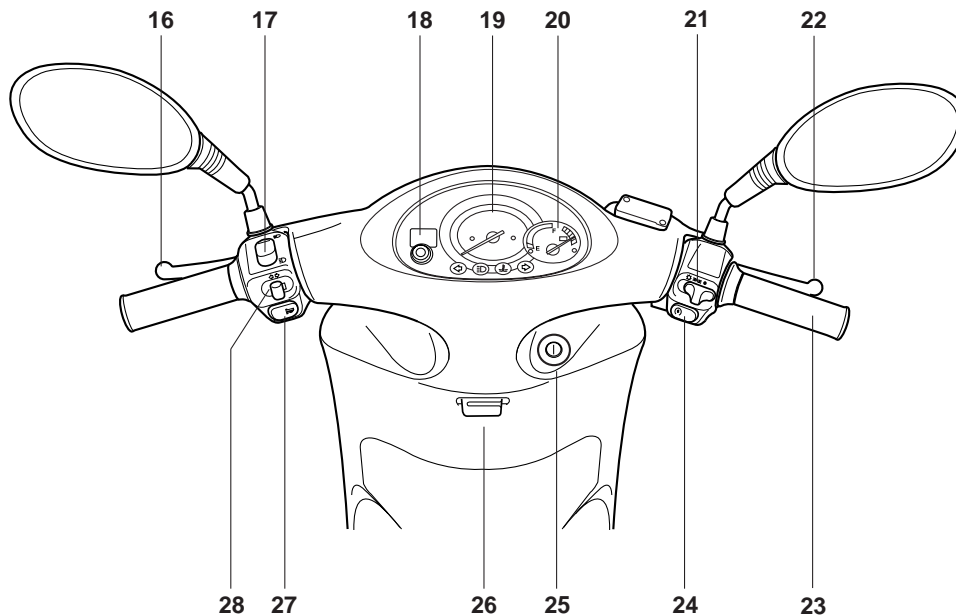

16. Rear brake lever (page 3-7)

17. Dimmer switch (page 3-6)

18. Odometer / Clock (3-4)

19. Speedometer (page 3-4)

20. Battery voltage / Fuel gauge (3-5)

21. Light switch (page 3-6)

22. Front brake lever (page 3-7)

23. Throttle grip (page 6-17)

24. Start switch (page 3-6)

25. Main switch / Steering lock (page 3-1)

26. Luggage hook (page 3-10)

27. Horn switch (page 3-6)

28. Turn signal switch (page 3-6)

# INSTRUMENT AND CONTROL FUNCTIONS

---

---

Main switch / steering lock .....	3-1
Indicator lights .....	3-2
Coolant temperature warning light check.....	3-3
Speedometer unit.....	3-4
Selecting miles or kilometers .....	3-4
Battery voltage / Fuel gauge .....	3-5
Clock .....	3-5
Handlebar switches.....	3-6
Front brake lever .....	3-7
Rear brake lever.....	3-7
Fuel tank cap.....	3-7
Fuel .....	3-8
Catalytic converter .....	3-9
Seat.....	3-9
Storage compartment.....	3-9
Luggage hook .....	3-10



# INSTRUMENT AND CONTROL FUNCTIONS

3

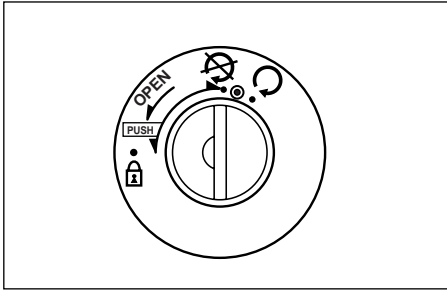

EAU00029

## Main switch/steering lock

The main switch/steering lock controls the ignition and lighting systems, and is used to lock the steering. The various positions are described below.

EAU00036

### ON “☉”

All electrical systems are supplied with power, and the engine can be started. The key cannot be removed.

EAU00038

### OFF “☹”

All electrical systems are off. The key can be removed.

EAU00038

### “☉”

The coolant temperature warning light should come on, when the key is turned to “☉”. See page 3-2 for an explanation of the coolant temperature warning light.

EAU00015

### LOCK “🔒”

The steering is locked, and all electrical systems are off. The key can be removed.

#### To lock the steering

1. Turn the handlebars all the way to the left or right.
2. Push the key in from the “OFF” position, and then turn it to “LOCK” while still pushing it.
3. Remove the key.

#### To unlock the steering

Push the key into the main switch, and then turn it to “OFF” while still pushing it.

EW000016

### **⚠️ WARNING**

Never turn the key to “OFF” or “LOCK” while the scooter is moving, otherwise the electrical systems will be switched off, which may result in loss of control or an accident. Make sure that the scooter is stopped before turning the key to “OFF” or “LOCK”.

### NOTE:

Always turn the main switch to “OFF” or “LOCK” and remove the key when the scooter is unattended.

# INSTRUMENT AND CONTROL FUNCTIONS

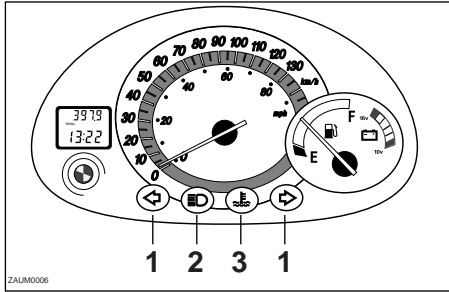

1. Turn indicator lights “”
2. High beam indicator light “”
3. Coolant temperature warning light “”

EAU00056

## Indicator lights

EAU03125

### Turn indicator lights “”

The corresponding indicator flashes when the turn signal switch is moved to the left or right.

EAU00064

### High beam indicator light “”

This indicator light comes on when the high beam of the headlight is switched on.

EAU01716

### Coolant temperature warning light

“”

This warning light comes on when the engine overheats. When this occurs, stop the engine immediately and allow the engine to cool.

EC000002

### **CAUTION:**

**Do not operate the engine if it is overheated.**

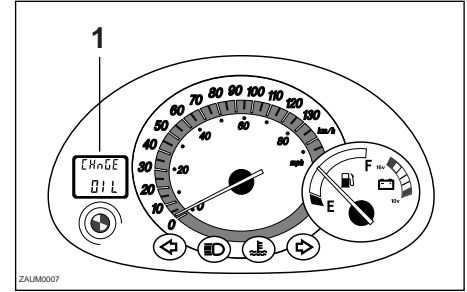

1. Oil change indicator “CHnGE OIL”

EAUM0048

### Oil change indicator

At the initial 500 km and every 3,000 km thereafter, the message “CHnGE OIL” appears in the odometer/clock display to indicate that the engine oil should be changed. (See page 6-10 for the resetting procedure.)

# INSTRUMENT AND CONTROL FUNCTIONS

EAU01292

## Coolant temperature warning light check

3

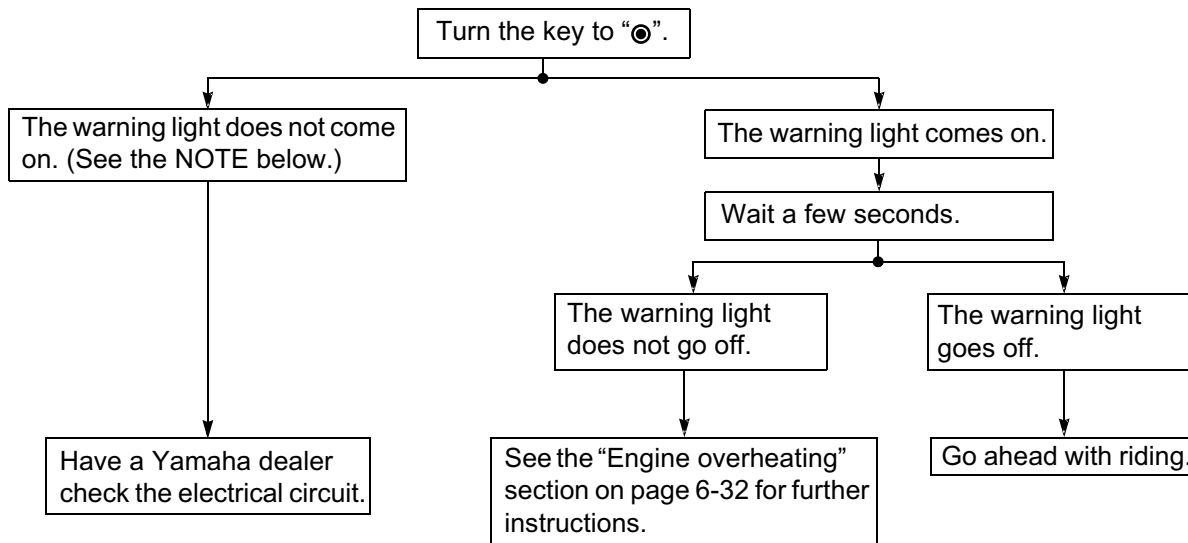

### NOTE:

If, after the warning light goes off, the key is turned to "OFF" and then immediately back to "ON", the warning light may not come on again, but this does not indicate a malfunction.

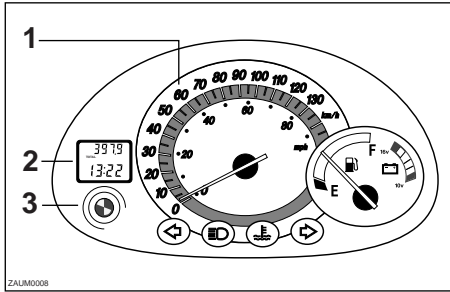

1. Speedometer
2. Odometer
3. "TRIP" button

EAU01586

## Speedometer unit

The speedometer unit is equipped with a speedometer, an odometer and a tripmeter. The speedometer shows riding speed. The odometer shows the total distance traveled. The tripmeter shows the distance traveled since it was last set to zero.

Pushing the "TRIP" button switches the display between the odometer mode "TOTAL" and the tripmeter mode "TRIP". To reset the tripmeter, enter the "TRIP" mode, and then hold down the "TRIP" button for at least two seconds.

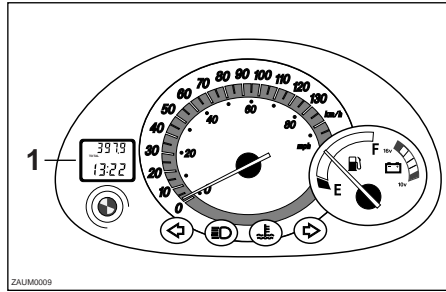

1. Tripmeter

The tripmeter can be used together with the fuel gauge to estimate the distance that can be traveled with a full tank of fuel. This information will enable you to plan future fuel stops.

## Setting the odometer/tripmeter reading mode

The odometer and tripmeter can be set to count in either miles or kilometers according to the following procedure.

1. Turn the key to "ON" while pressing the "TRIP" button.
2. Release the "TRIP" button when the display comes on.
3. The current mode appears in the display: "CONT" (continental) for the kilometer mode and "EnGL" (English) for the mile mode.
4. Press the "TRIP" button to switch the mode.
5. Press the "TRIP" button for two seconds to confirm the setting.

### NOTE:

- The odometer/tripmeter reading mode can be changed any number of times while the odometer reading is below 10, but it cannot be changed anymore after the reading has reached 10.
- Switching between the mile and the kilometer mode does not change or convert the current odometer/tripmeter reading.

# INSTRUMENT AND CONTROL FUNCTIONS

3

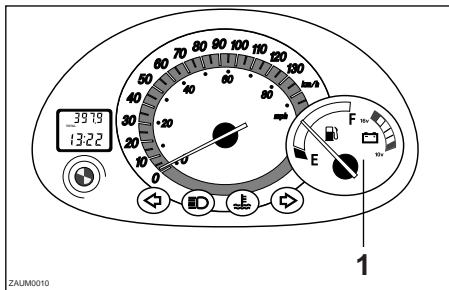

1. Battery voltage / Fuel gauge

EAUM0039

## Battery voltage/fuel gauge

When the key is turned to “OFF”, the voltage/fuel gauge indicates the battery voltage.

**NOTE:** \_\_\_\_\_

If the battery voltage drops to 10 V, have a Yamaha dealer check the battery.

When the key is turned to “ON”, the voltage/fuel gauge indicates the amount of fuel in the fuel tank after indicating the battery voltage for two seconds. The needle moves towards “E” (empty) as the fuel level decreases. When the needle reaches “E”, refuel as soon as possible.

**NOTE:** \_\_\_\_\_  
Do not allow the fuel tank to empty itself completely.  
\_\_\_\_\_

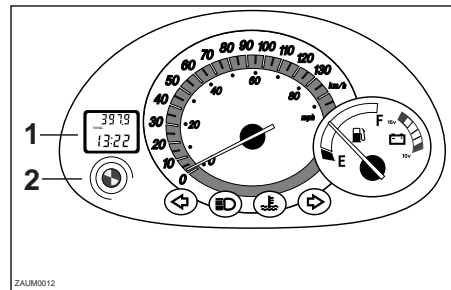

1. Clock  
2. “TRIP” button

EAUM0041

## Clock

**To set the clock:**

1. Turn the key to “ON”.
2. Press the “TRIP” button for two seconds, and the hour display will flash.
3. Press the “TRIP” button to set the hours.
4. Press the “TRIP” button for two seconds, and the first minute digit will flash.
5. Press the “TRIP” button to set the first minute digit.
6. Press the “TRIP” button for two more seconds, and the second minute digit will flash.

# INSTRUMENT AND CONTROL FUNCTIONS

7. Press the “TRIP” button to set the second minute digit.
8. Press the “TRIP” button for two seconds to set the clock.

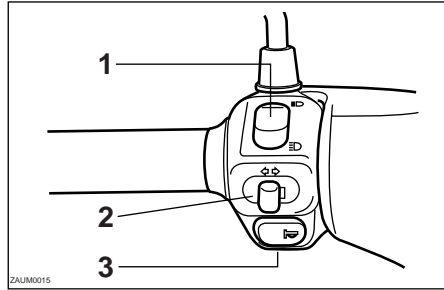

1. Dimmer switch “☀, ☀”
2. Horn switch “📣”
3. Turn signal switch “↔”

EAU00118

## Handlebar switches

EAU00121

### Dimmer switch

Set this switch to “☀” for the high beam and to “☀” for the low beam.

EAU00129

### Horn switch “📣”

Press this switch to sound the horn.

EAU00125

### Turn signal switch “↔”

To signal a right-hand turn, push this switch to the right. To signal a left-hand turn, push this switch to the left. When released, the switch returns to the center position. To cancel the turn signal lights, push the switch in after it has returned to the center position.

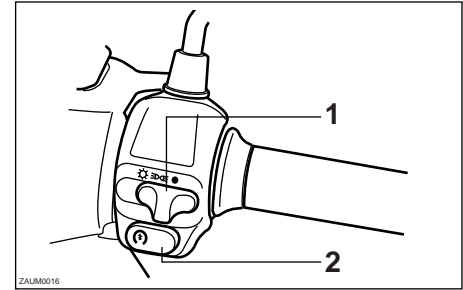

1. Light switch “☀, ☀”
2. Start switch “🌀”

EAU00132

### Light switch “☀, ☀”

Set this switch to “☀” to turn on the auxiliary light, taillight and meter lighting. Set the switch to “☀” to turn on the headlight also.

EAU00142

### Start switch “🌀”

Push this switch while applying the front or rear brake to crank the engine with the starter.

EC000005

### CAUTION:

**See page 5-1 for starting instructions prior to starting the engine.**

# INSTRUMENT AND CONTROL FUNCTIONS

3

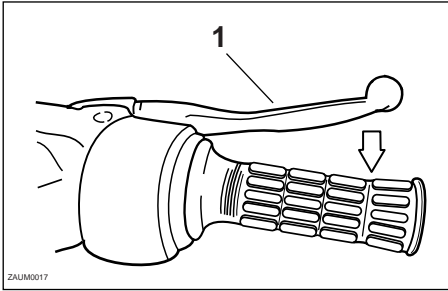

1. Front brake lever

EAU03035

## Front brake lever

The front brake lever is located at the right handlebar grip. To apply the front brake, pull this lever toward the handlebar grip.

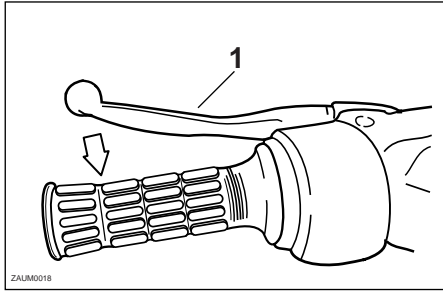

1. Rear brake lever

EAU00163

## Rear brake lever

The rear brake lever is located on the left handlebar grip. To apply the rear brake, pull this lever toward the handlebar grip.

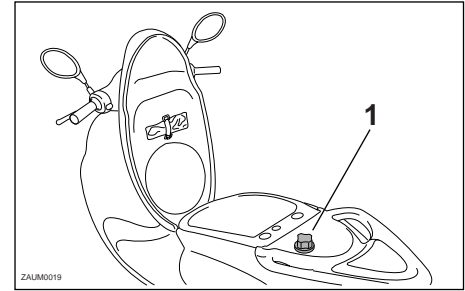

1. Fuel tank cap

EAU00180

## Fuel tank cap

### To remove the fuel tank cap

1. Open the seat.
2. Turn the fuel tank cap counterclockwise and pull it off.

### To install the fuel tank cap

1. Insert the fuel tank cap into the tank opening and turn it clockwise.
2. Close the seat.

EWA00025

## **⚠ WARNING**

**Make sure that the fuel tank cap is properly closed before riding.**

# INSTRUMENT AND CONTROL FUNCTIONS

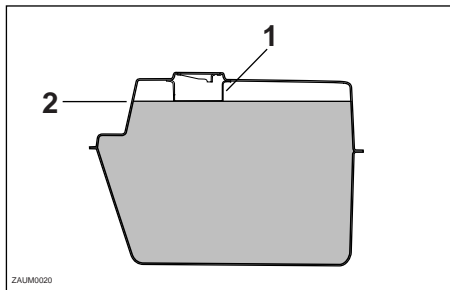

1. Filler tube
2. Fuel level

EAU01184

## Fuel

Make sure that there is sufficient fuel in the tank. When refueling, be sure to insert the pump nozzle into the fuel tank filler hole and to fill the tank to the bottom of the filler tube, as shown in the illustration.

EW000130

### **⚠ WARNING**

**Do not overfill the fuel tank, otherwise it may overflow when the fuel warms up and expands.**

**Avoid spilling fuel on the hot engine.**

EAU00185  
EC000008

### **CAUTION:**

**Immediately wipe off spilled fuel with a clean, dry, soft cloth, since fuel may deteriorate painted surfaces or plastic parts.**

EAU00191

### Recommended fuel:

Regular unleaded gasoline with a research octane number of 91 or higher

### Fuel tank capacity:

Total amount:  
10 L

### **NOTE:**

If knocking (or pinging) occurs, use gasoline of a different brand or with a higher octane grade.

EWA00008

### **⚠ WARNING**

**Since gasoline is flammable, the following precautions must be observed.**

- Stop the engine before refueling.
- Never attempt to refuel the scooter while smoking or near an open flame.
- Take special care not to spill gasoline over the engine or muffler when refueling immediately after operation.
- Before starting the engine, quickly wipe off any gasoline spilled on the engine or muffler.



# INSTRUMENT AND CONTROL FUNCTIONS

## Catalytic converter

EAU01084

This scooter is equipped with a catalytic converter in the exhaust chamber.

EW000128

### **⚠ WARNING**

**The exhaust system is hot after operation. Make sure that the exhaust system has cooled down before doing any maintenance work.**

EC000114

### **CAUTION:**

The following precautions must be observed to prevent a fire hazard or other damages.

- Use only unleaded gasoline. The use of leaded gasoline will cause unreparable damage to the catalytic converter.
- Never park the scooter near possible fire hazards such as grass or other materials that easily burn.
- Do not allow the engine to idle too long.

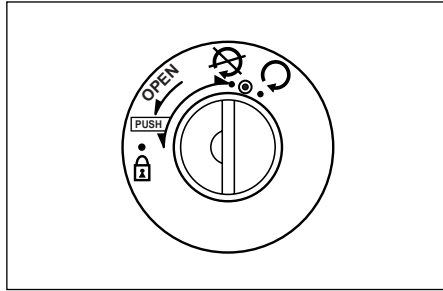

EAU02978

## Seat

### To open the seat

1. Insert the key in the lock, and then turn it as shown.
2. Fold the seat up.

### To close the seat

1. Fold the seat down, and then push it down to lock it in place.
2. Remove the key.

### NOTE:

Make sure that the seat is properly secured before riding.

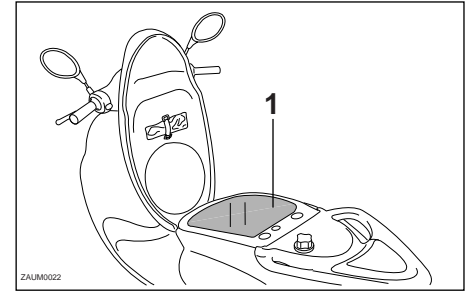

1. Storage compartment

EAU00268

## Storage compartment

There is a storage compartment under the seat.

EWA00005

### **⚠ WARNING**

**Do not exceed the load limit of 3.0 kg for the storage compartment.**  
**Do not exceed the maximum load of 310 kg for the vehicle.**

# INSTRUMENT AND CONTROL FUNCTIONS

EC000010

## CAUTION:

Keep the following points in mind when using the storage compartment.

- Since the storage compartment accumulates heat when exposed to the sun, do not store anything susceptible to heat inside it.
- To avoid humidity from spreading through the storage compartment, wrap wet articles in a plastic bag before storing them in the compartment.
- Since the storage compartment may get wet while the scooter is being washed, wrap any articles stored in the compartment in a plastic bag.
- Do not keep anything valuable or breakable in the storage compartment.

To store a helmet in the storage compartment, place the helmet upside-down with the front facing forward.

## NOTE:

Some helmets cannot be stored in the storage compartment because of their size or shape.

Do not leave your scooter unattended with the seat open.

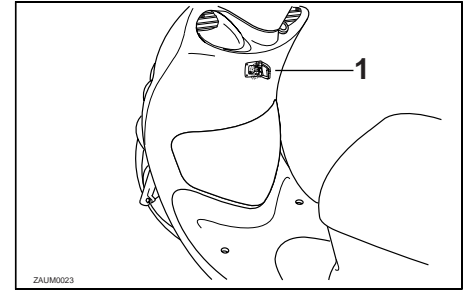

1. Luggage hook

EAUM0043

## Luggage hook

EWUM0006

### ⚠ WARNING

- Do not exceed the load limit of 3.0 kg for the luggage hook.
- Do not exceed the maximum load of 310 kg for the vehicle.



Pre-operation check list..... 4-1

# PRE-OPERATION CHECKS

The condition of a vehicle is the owner's responsibility. Vital components can start to deteriorate quickly and unexpectedly, even if the vehicle remains unused (for example, as a result of exposure to the elements). Any damage, fluid leakage or loss of tire air pressure could have serious consequences. Therefore, it is very important, in addition to a thorough visual inspection, to check the following points before each ride.

EAUM0020

## PRE-OPERATION CHECK LIST

ITEM	Checks	Page
<b>Front brake (disc)</b>	<ul style="list-style-type: none"> <li>• Check operation, free play, fluid level and vehicle for fluid leakage.</li> <li>• Fill with DOT #3 or DOT #4 brake fluid if necessary.</li> </ul>	3-7/6-19
<b>Rear brake (drum)</b>	<ul style="list-style-type: none"> <li>• Check operation, damage and free play.</li> <li>• Adjust if necessary.</li> </ul>	3-7/6-20
<b>Throttle grip and housing</b>	<ul style="list-style-type: none"> <li>• Check for smooth operation.</li> <li>• Adjust / Lubricate if necessary.</li> </ul>	6-17
<b>Engine oil</b>	<ul style="list-style-type: none"> <li>• Check engine oil level.</li> <li>• Add oil if necessary.</li> </ul>	6-10
<b>Final gear oil</b>	<ul style="list-style-type: none"> <li>• Check vehicle for leakage.</li> <li>• Add oil if necessary.</li> </ul>	6-12
<b>Air filter</b>	<ul style="list-style-type: none"> <li>• Check the condition of dry element</li> </ul>	6-14
<b>Wheels/Tires</b>	<ul style="list-style-type: none"> <li>• Check tires pressure, wear and damage.</li> </ul>	6-17
<b>Fittings/ Fasteners</b>	<ul style="list-style-type: none"> <li>• Check all chassis fittings and fasteners.</li> <li>• Adjust if necessary.</li> </ul>	-
<b>Lights, signals and switches</b>	<ul style="list-style-type: none"> <li>• Check for proper operation. Correct if necessary.</li> </ul>	3-6
<b>Battery</b>	<ul style="list-style-type: none"> <li>• Check the battery fluid level.</li> <li>• Add with distilled water if necessary.</li> </ul>	6-25

# PRE-OPERATION CHECKS

---

---

**NOTE:** \_\_\_\_\_  
Pre-operation checks should be made each time the scooter is used. Such an inspection can be accomplished in a very short time; and the added safety it assures is more than worth the time involved.

---

EWUM0002

**⚠WARNING** \_\_\_\_\_  
If any item in the pre-operation check is not working properly, have it inspected and repaired before operating the scooter.

---

EWUM0003

**⚠WARNING** \_\_\_\_\_  
Do not leave a rag which may have been used to clean up gasoline or oil behind any cowling or panel.

---



# OPERATION AND IMPORTANT RIDING POINTS

---

---

Starting a cold engine .....	5-1
Starting off .....	5-2
Acceleration and deceleration .....	5-2
Braking .....	5-2
Engine break-in .....	5-3
Parking .....	5-4



# OPERATION AND IMPORTANT RIDING POINTS

EAU01118  
EW000129

## **⚠ WARNING**

1. Become thoroughly familiar with all operating controls and their functions before riding. Consult a Yamaha dealer regarding any control or function that you do not thoroughly understand.
2. Never start the engine or operate it in a closed area for any length of time. Exhaust fumes are poisonous, and inhaling them can cause loss of consciousness and death within a short time. Always make sure that there is adequate ventilation.
3. For safety, always start the engine with the centerstand down.

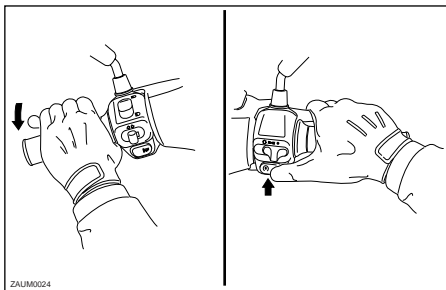

## Starting a cold engine

EAU00044

EC000046

### **CAUTION:**

See page 5-3 for engine break-in instructions prior to operating the vehicle for the first time.

1. Turn the key to "ON".
2. Close the throttle completely.
3. Start the engine by pushing the start switch while applying the front or rear brake.

### **NOTE:**

If the engine fails to start, release the start switch, wait a few seconds, and then try again. Each starting attempt should be as short as possible to preserve the battery. Do not crank the engine more than 10 seconds on any one attempt.

ECA00045

### **CAUTION:**

For maximum engine life, never accelerate hard when the engine is cold!

# OPERATION AND IMPORTANT RIDING POINTS

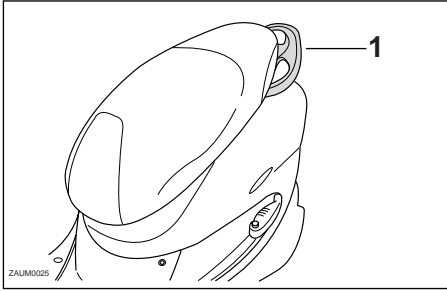

1. Passenger handle

EAUM0027

## Starting off

Before starting off, allow the engine to warm up.

1. While pulling the rear brake lever with your left hand and holding the passenger handle with your right hand, push the scooter off the centerstand.
2. Sit astride the seat, and then adjust the rear view mirrors.
3. Switch the turn signal on.
4. Check for oncoming traffic, and then slowly turn the throttle grip (on the right) in order to take off.
5. Switch the turn signal off.

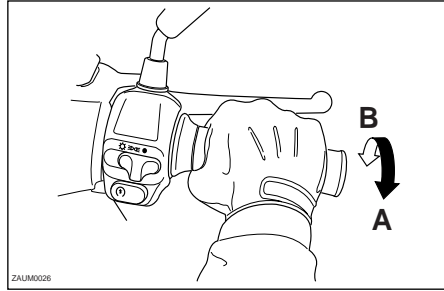

ZAUM0026

## Acceleration and deceleration

The speed can be adjusted by opening and closing the throttle. To increase the speed, turn the throttle grip in direction A. To reduce the speed, turn the throttle grip in direction B.

EAU00434

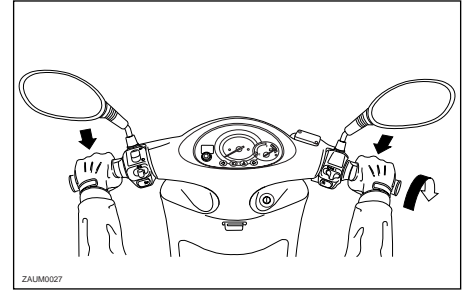

ZAUM0027

## Braking

1. Close the throttle completely.
2. Apply both front and rear brakes simultaneously while gradually increasing the pressure.

5

# OPERATION AND IMPORTANT RIDING POINTS

---

---

EW000057

## **⚠ WARNING**

- **Avoid braking hard or suddenly (especially when leaning over to one side), otherwise the scooter may skid or overturn.**
  - **Railroad crossings, streetcar rails, iron plates on road construction sites, and manhole covers become extremely slippery when wet. Therefore, slow down when approaching such areas and cross them with caution.**
  - **Keep in mind that braking on a wet road is much more difficult.**
  - **Ride slowly down a hill, as braking downhill can be very difficult.**
- 

5

## **Engine break-in**

There is never a more important period in the life of your engine than the period between 0 and 1,000 km. For this reason, you should read the following material carefully.

Since the engine is brand new, do not put an excessive load on it for the first 1,000 km. The various parts in the engine wear and polish themselves to the correct operating clearances. During this period, prolonged full-throttle operation or any condition that might result in engine overheating must be avoided.

### **0 ~ 150 km**

Avoid prolonged operation above 1/3 throttle.

After every hour of operation, stop the engine, and then let it cool for five to ten minutes.

Vary the engine speed from time to time. Do not operate the engine at one set throttle position.

EAU00436

### **150 ~ 500 km**

Avoid prolonged operation above 1/2 throttle.

ECUM0003

## **CAUTION:**

**After 500 km of operation, the final gear oil and engine oil must be changed and the oil strainer cleaned.**

### **500 ~ 1,000 km**

Avoid prolonged operation above 3/4 throttle.

### **1,000 km and beyond**

Avoid prolonged full-throttle operation. Vary the engine speed occasionally.

EAUM0051

EC000049

## **CAUTION:**

**If any engine trouble should occur during the engine break-in period, immediately have a Yamaha dealer check the vehicle.**

---

EAU00461

## Parking

When parking, stop the engine, and then remove the key from the main switch.

EW000058

### **⚠ WARNING**

Since the engine and exhaust system can become very hot, park in a place where pedestrians or children are not likely to touch them. Do not park on a slope or on soft ground, otherwise the scooter may overturn.

---

EC000062

### **CAUTION:**

Never park in an area where there are fire hazards such as grass or other flammable materials.

---



# PERIODIC MAINTENANCE AND MINOR REPAIR

Owner's tool kit .....	6-1	Checking and lubricating the centerstand .....	6-23
Periodic maintenance and lubrication chart .....	6-2	Checking the front fork .....	6-23
Removing and installing cowlings and panels.....	6-5	Checking the steering .....	6-24
Panel A .....	6-6	Checking the wheel bearings .....	6-24
Panel B .....	6-6	Battery .....	6-25
Cowling C .....	6-7	Replacing the fuse .....	6-26
Checking the spark plug.....	6-8	Replacing a headlight bulb or a front turn signal light bulb .....	6-27
Engine oil and oil strainer .....	6-10	Replacing a rear turn signal light bulb.....	6-28
Final gear oil.....	6-12	Replacing taillight bulb .....	6-29
Coolant .....	6-13	Troubleshooting .....	6-30
Air filter and the V-belt case air filter elements .....	6-14	Troubleshooting chart .....	6-31
Adjusting the carburetor .....	6-17	Engine overheating .....	6-32
Adjusting the throttle cable free play .....	6-17		
Tires .....	6-17		
Wheels .....	6-19		
Front brake adjustment .....	6-19		
Adjusting the rear brake lever free play .....	6-20		
Checking the front brake pads and rear brake shoes .....	6-20		
Checking the brake fluid level .....	6-21		
Changing the brake fluid .....	6-22		
Checking and lubricating the cables .....	6-22		
Lubricating the front and rear brakes levers.....	6-23		

# PERIODIC MAINTENANCE AND MINOR REPAIR

EAU00464

Safety is an obligation of the owner. Periodic inspection, adjustment and lubrication will keep your vehicle in the safest and most efficient condition possible. The most important points of inspection, adjustment, and lubrication are explained on the following pages.

The intervals given in the periodic maintenance and lubrication chart should be simply considered as a general guide under normal riding conditions. However, DEPENDING ON THE WEATHER, TERRAIN, GEOGRAPHICAL LOCATION, AND INDIVIDUAL USE, THE MAINTENANCE INTERVALS MAY NEED TO BE SHORTENED.

EW000060

## **⚠ WARNING**

**If you are not familiar with scooter maintenance work, have a Yamaha dealer do it for you.**

EAU00466  
EC000061

## **CAUTION:**

**This scooter is designed for use on paved roads only. If this scooter is operated in abnormally dusty, muddy or wet conditions, the air filter element should be cleaned or replaced more frequently, otherwise rapid engine wear may result. Consult a Yamaha dealer for proper maintenance intervals.**

EW000063

## **⚠ WARNING**

**Modifications not approved by Yamaha may cause loss of performance and render the vehicle unsafe for use. Consult a Yamaha dealer before attempting any changes.**

EW000063

## **⚠ WARNING**

**Modifications not approved by Yamaha may cause loss of performance and render the vehicle unsafe for use. Consult a Yamaha dealer before attempting any changes.**

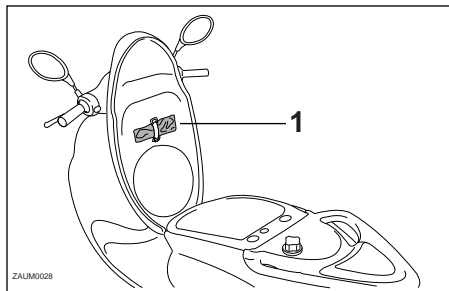

1. Owner's tool kit

EAU00469

## **Owner's tool kit**

The service information included in this manual and the tools provided in the owner's tool kit are intended to assist you in the performance of preventive maintenance and minor repairs. However, additional tools such as a torque wrench may be necessary to perform certain maintenance work correctly.

## **NOTE:**

If you do not have the tools or experience required for a particular job, have a Yamaha dealer perform it for you.

# PERIODIC MAINTENANCE AND MINOR REPAIR

EAUM0022

## Periodic maintenance and lubrication chart

### NOTE:

- The annual checks must be performed every year, except if a kilometer-based is performed instead.
- From 30,000 km, repeat the maintenance intervals starting from 6,000 km.
- Items marked with an asterisk should be performed by a Yamaha dealer as they require special tools, data and technical skills.

N°	Item	Check and maintenance and lubrication	ODOMETER READING (X 1,000 KM)					Annual check
			0.5	6	12	18	24	
1	* Fuel line	• Check fuel hoses and vacuum hose for cracks or damage.		√	√	√	√	√
2	Spark plug	• Check condition. • Clean, regap.		√		√		
		• Replace.			√		√	
3	* Valves	• Check valve clearance. • Adjust.					√	
4	Air filter	• Clean.		√		√		
		• Replace.			√		√	
5	V-belt (crankcase) air filter	• Clean.		√	√	√	√	
6	* Battery	• Check electrolyte level and specific gravity. • Make sure that the breather hose is properly routed.		√	√	√	√	√
7	* Front brake (disc)	• Check operation, fluid level and vehicle for fluid leakage. (See NOTE on page 6-4)	√	√	√	√	√	√
		• Replace brake pads.	Whenever necessary					
8	* Rear brake (drum)	• Check operation and adjust brake lever freeplay.	√	√	√	√	√	√
		• Replace brake shoes.	Whenever necessary					
9	* Brake hose	• Check for cracks or damage.		√	√	√	√	√
		• Replace.	Every 4 years.					



# PERIODIC MAINTENANCE AND MINOR REPAIR

N°	Item	Check and maintenance and lubrication	ODOMETER READING (X 1,000 KM)					Annual check
			0.5	6	12	18	24	
10	* Wheels	<ul style="list-style-type: none"> <li>• Check runout and for damage.</li> </ul>		√	√	√	√	
11	* Tires	<ul style="list-style-type: none"> <li>• Check tread depth and for damage.</li> <li>• Replace if necessary.</li> <li>• Check air pressure.</li> <li>• Correct if necessary.</li> </ul>		√	√	√	√	
12	* Wheel bearings	<ul style="list-style-type: none"> <li>• Checks bearing for looseness or damage.</li> </ul>		√	√	√	√	
13	* Steering bearings	<ul style="list-style-type: none"> <li>• Check bearing play and steering for roughness.</li> </ul>	√	√	√	√	√	
		<ul style="list-style-type: none"> <li>• Lubricate with lithium soap base grease.</li> </ul>			√		√	
14	Chassis fasteners	<ul style="list-style-type: none"> <li>• Make sure that all nuts, bolts and screws are properly tightened.</li> </ul>		√	√	√	√	√
15	Centerstand	<ul style="list-style-type: none"> <li>• Check operation.</li> <li>• Lubricate.</li> </ul>		√	√	√	√	√
16	* Front fork	<ul style="list-style-type: none"> <li>• Check operation and for oil leakage.</li> </ul>		√	√	√	√	
17	* Rear shock absorber assembly	<ul style="list-style-type: none"> <li>• Check operation and shock absorber for oil leakage.</li> </ul>		√	√	√	√	
18	* Carburetor	<ul style="list-style-type: none"> <li>• Check engine idling speed and starter operation.</li> </ul>	√	√	√	√	√	√
19	* Engine oil	<ul style="list-style-type: none"> <li>• Change.</li> </ul>	√	Every 3,000 km				√
20	* Engine oil filter strainer	<ul style="list-style-type: none"> <li>• Clean.</li> </ul>	√		√		√	
21	* Final gear oil	<ul style="list-style-type: none"> <li>• Check vehicle for oil leakage</li> </ul>		√		√		
		<ul style="list-style-type: none"> <li>• Change.</li> </ul>	√		√		√	
22	* Coolant system	<ul style="list-style-type: none"> <li>• Check coolant level and vehicle for coolant leakage.</li> </ul>		√	√	√	√	√
		<ul style="list-style-type: none"> <li>• Change.</li> </ul>	Every 3 year					
23	V-belt	<ul style="list-style-type: none"> <li>• Check wear and damage.</li> </ul>		√	√	√	√	
		<ul style="list-style-type: none"> <li>• Replace.</li> </ul>	Every 18,000 km					

# PERIODIC MAINTENANCE AND MINOR REPAIR

N°	Item	Check and maintenance and lubrication	ODOMETER READING (X 1,000 KM)					Annual check
			0.5	6	12	18	24	
25	Moving parts and cables	• Lubricate.		√	√	√	√	√
26	* Lights, signals and switches	• Check operation. • Adjust headlight beam.	√	√	√	√	√	√

**NOTE:** \_\_\_\_\_

- The air filter needs more frequent service if you are riding in unusually wet or dusty areas.
- Hydraulic brake service
  - Regularly check and, if necessary, correct the brake fluid level.
  - Every two years replace the brake fluid.

# PERIODIC MAINTENANCE AND MINOR REPAIR

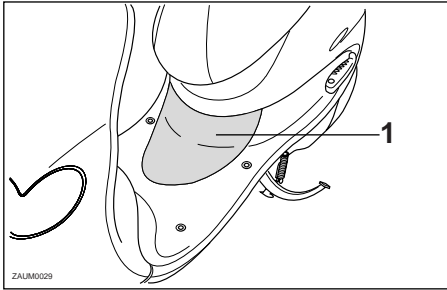

1. Cover A

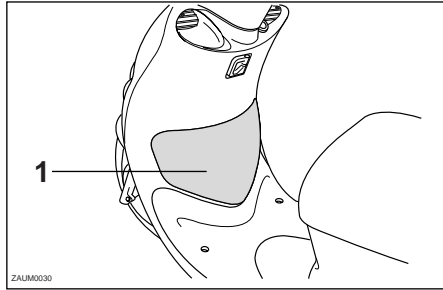

1. Cover B

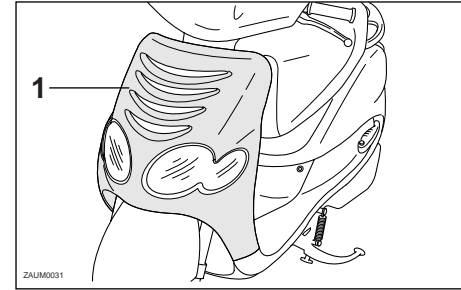

1. Cover C

EAU01139

## Removing and installing cowlings and panels

The cowlings and panels shown above need to be removed to perform some of the maintenance jobs described in this chapter. Refer to this section each time a cowling or panel needs to be removed and installed.

6

# PERIODIC MAINTENANCE AND MINOR REPAIR

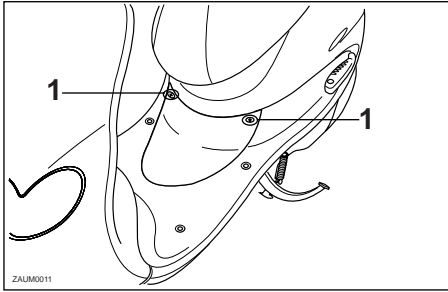

1. Screw

EAU01315

## Panel A

### To remove the panel

Remove the screws, and then take the panel off.

### To install the panel

Place the panel in the original position, and then install the screws.

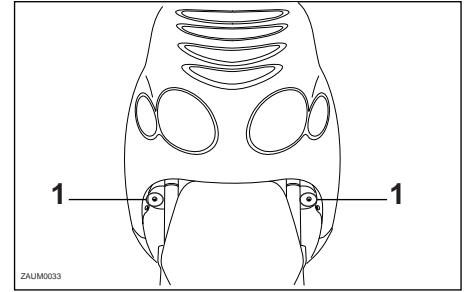
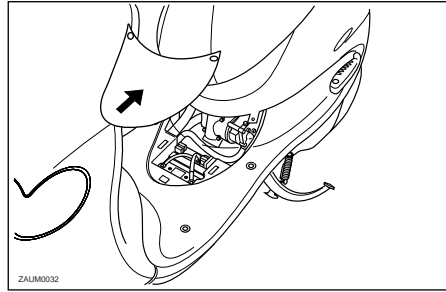

1. Screw

EAU01315

## Panel B

### To remove the panel

Remove the screws, and then take the panel off.

### To install the panel

Place the panel in the original position, and then install the screws.

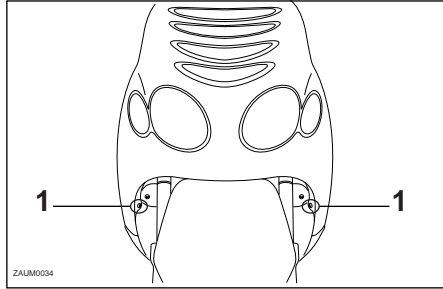
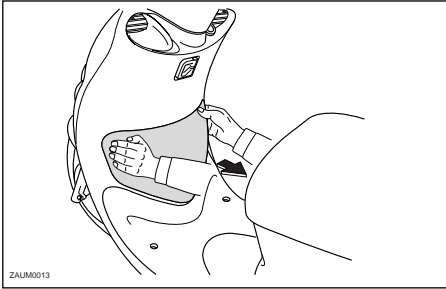

1. Screw

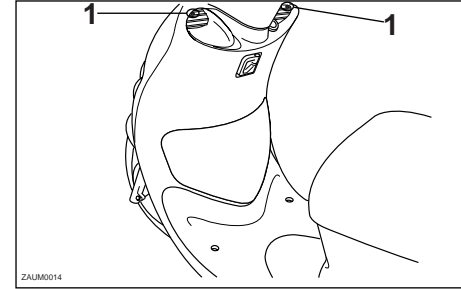

1. Screw

EAU00482

## Cowling C

### To remove the cowling

Remove the screws, and then take the cowling off.

### To install the cowling

Place the cowling in the original position, and then install the screws.

# PERIODIC MAINTENANCE AND MINOR REPAIR

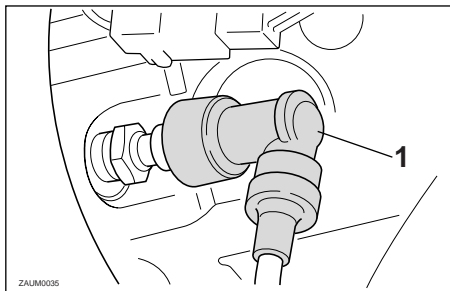

1. Spark plug cap

EAU01833

## Checking the spark plug

The spark plug is an important engine component, which is easy to check. Since heat and deposits will cause any spark plug to slowly erode, the spark plug should be removed and checked in accordance with the periodic maintenance and lubrication chart. In addition, the condition of the spark plug can reveal the condition of the engine.

### To remove the spark plug

1. Remove the spark plug cap.

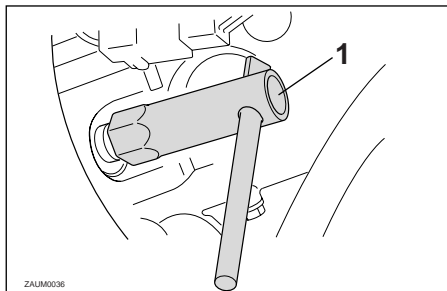

1. Spark plug wrench

2. Remove the spark plug as shown, with the spark plug wrench included in the owner's tool kit.

### To check the spark plug

1. Check that the porcelain insulator around the center electrode of the spark plug is a medium-to-light tan (the ideal color when the motorcycle is ridden normally).

### NOTE:

If the spark plug shows a distinctly different color, the engine could be defective. Do not attempt to diagnose such problems yourself. Instead, have a Yamaha dealer check the motorcycle.

2. Check the spark plug for electrode erosion and excessive carbon or other deposits, and replace it if necessary.

# PERIODIC MAINTENANCE AND MINOR REPAIR

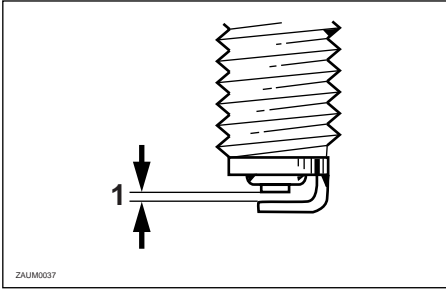

1. Spark plug gap

Specified spark plug:  
CR8E (NGK)

6

## To install the spark plug

1. Measure the spark plug gap with a wire thickness gauge and, if necessary, adjust the gap to specification.

Spark plug gap:  
0.5 ~ 0.7 mm

2. Clean the surface of the spark plug gasket and its mating surface, and then wipe off any grime from the spark plug threads.
3. Install the spark plug with the spark plug wrench, and then tighten it to the specified torque.

Tightening torque:  
Spark plug:  
20 Nm (2.0 m•kg)

## **NOTE:** \_\_\_\_\_

If a torque wrench is not available when installing a spark plug, a good estimate of the correct torque is 1/4 ~ 1/2 turn past finger tight. However, the spark plug should be tightened to the specified torque as soon as possible.

4. Install the spark plug cap.

# PERIODIC MAINTENANCE AND MINOR REPAIR

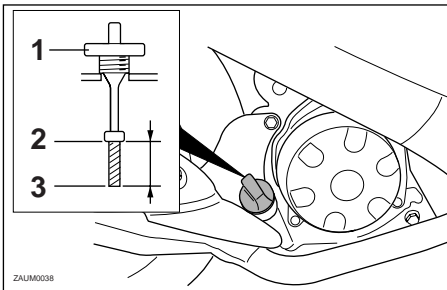

1. Dipstick
2. Maximum level
3. Minimum level

EAU00513

## Engine oil and oil strainer

The engine oil level should be checked before each ride. In addition, the oil must be changed and the oil strainer cleaned at the intervals specified in the periodic maintenance and lubrication chart and when the oil change indicator light comes on.

### To check the engine oil level

1. Place the scooter on the centerstand.

**NOTE:** \_\_\_\_\_  
Make sure that the scooter is positioned straight up when checking the oil level. A slight tilt to the side can result in a false reading.

2. Start the engine, warm it up for several minutes, and then turn it off.
3. Wait a few minutes until the oil settles, remove the oil filler cap, wipe the dipstick clean, insert it back into the oil filler hole (without screwing it in), and then remove it again to check the oil level.

**NOTE:** \_\_\_\_\_  
The engine oil should be between the minimum and maximum level marks.

4. If the engine oil is below the minimum level mark, add sufficient oil of the recommended type to raise it to the correct level.
5. Insert the dipstick into the oil filler hole, and then tighten the oil filler cap.

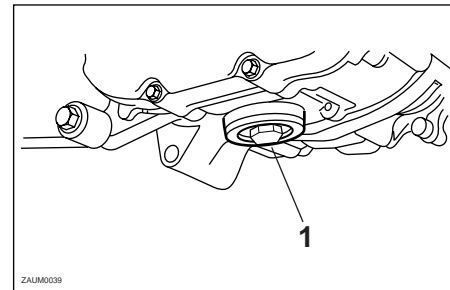

1. Engine oil drain plug

## To change the engine oil and clean the oil strainer

1. Start the engine, warm it up for several minutes, and then turn it off.
2. Place an oil pan under the engine to collect the used oil.
3. Remove the engine oil filler cap and drain bolt to drain the oil from the crankcase.

EC000070

**CAUTION:** \_\_\_\_\_  
**When removing the engine oil drain bolt, the O-ring, spring, and oil strainer will fall out. Take care not to lose these parts.**



# PERIODIC MAINTENANCE AND MINOR REPAIR

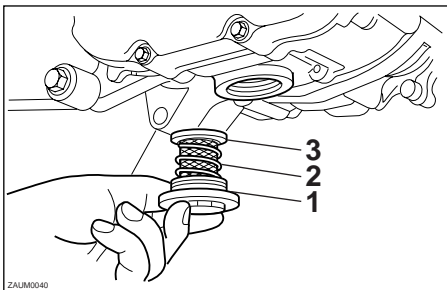

1. O-ring
2. Compression spring
3. Strainer

4. Clean the oil strainer with solvent, and then check it for damage and replace it if necessary.
5. Check the O-ring for damage and replace it if necessary.
6. Install the oil strainer, spring, O-ring and engine oil drain bolt, and then tighten the drain bolt to the specified torque.

Tightening torque:

Engine oil drain bolt:  
32 Nm (3.2 m•kg)

**NOTE:** \_\_\_\_\_  
Make sure that the O-ring is properly seated.  
\_\_\_\_\_

7. Add the specified amount of the recommended engine oil, and then install and tighten the oil filler cap.

Recommended engine oil:

See page 8-1.

Oil quantity:

Periodic oil change:

1.2 L

Total amount (dry engine):

1.4 L

8. Start the engine, and then let it idle for several minutes while checking it for oil leakage. If oil is leaking, immediately turn the engine off and check for the cause.
9. Reset the oil change indicator light according to the following procedure.

EC00030

**CAUTION:** \_\_\_\_\_

- **Do not mix any chemical additives with the oil or use oils of a higher grade than “CD”. In addition, do not use oils labeled “ENERGY CONSERVING II” or higher.**
- **Make sure that no foreign material enters the crankcase.**

# PERIODIC MAINTENANCE AND MINOR REPAIR

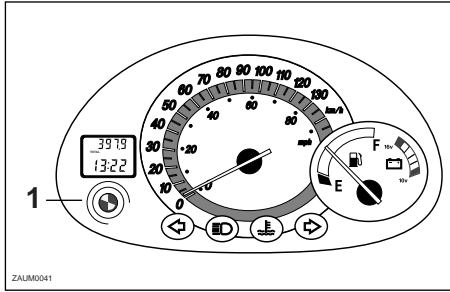

1. "TRIP" button

## To reset the oil change indicator light

1. Push the "TRIP" button while turning the key to "ON".
2. Release the reset button, and the oil change indicator light will go off.

## NOTE: \_\_\_\_\_

If the engine oil is changed before the oil change indicator light comes on (i.e. before the periodic oil change interval has been reached), the indicator light must be reset after the oil change for the next periodic oil change to be indicated at the correct time. To reset the oil change indicator light before the periodic oil change interval has been reached, follow the above procedure.

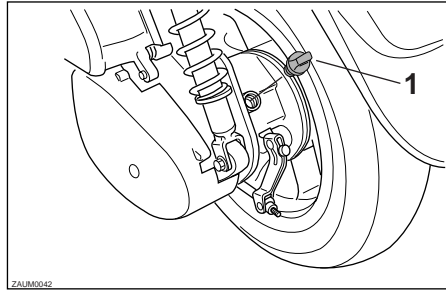

1. Oil filler bolt

## Final gear oil

The final gear case must be checked for oil leakage before each ride. If any leakage is found, have a Yamaha dealer check and repair the scooter. In addition, the final gear oil must be changed as follows at the intervals specified in the periodic maintenance and lubrication chart.

1. Place the scooter on the centerstand.

## NOTE: \_\_\_\_\_

Make sure that the scooter is positioned straight up when checking the oil level. A slight tilt to the side can result in a false reading.

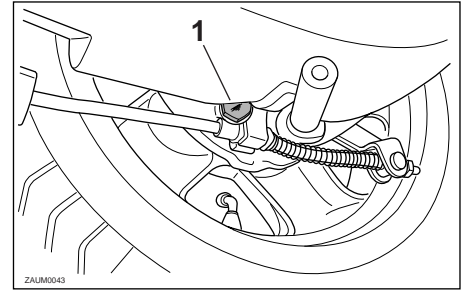

1. Oil drain bolt

2. Place an oil pan under the final gear case to collect the used oil.
3. Remove the oil filler bolt and drain bolt to drain the oil from the final gear case.
4. Install the final gear oil drain bolt, and then tighten it to the specified torque.

Tightening torque:

Final gear oil drain bolt:  
22 Nm (2.2 m•kg)

# PERIODIC MAINTENANCE AND MINOR REPAIR

5. Add the specified amount of the recommended final gear oil, and then install and tighten the oil filler bolt.

Recommended final gear oil:  
Engine oil SAE 10W30  
(API SE)  
Oil quantity:  
0.15 L

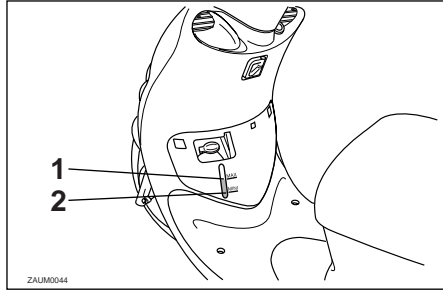

1. Maximum level mark
2. Minimum level mark

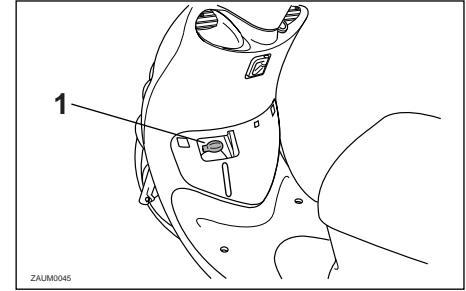

1. Coolant reservoir cap

EW000066

EAU01587

## **⚠ WARNING**

6

**Make sure that no foreign material enters the final gear case. Make sure that no oil gets on the tire or wheel.**

6. Check the final gear case for oil leakage. If oil is leaking, check for the cause.

## Coolant

### To check the coolant level

1. Place the scooter on the centerstand.

### NOTE: \_\_\_\_\_

- The coolant level must be checked on a cold engine since the level varies with engine temperature.
- Make sure that the scooter is positioned straight up when checking the coolant level. A slight tilt to the side can result in a false reading.

2. Remove panel B. (See page 6-6 for cover removal and installation procedures.)
3. Check the coolant level in the coolant reservoir.

### NOTE: \_\_\_\_\_

The coolant should be between the minimum and maximum level marks.

4. If the coolant is at or below the minimum level mark, open the reservoir cap, add coolant to the maximum level mark, and then close the reservoir cap.

# PERIODIC MAINTENANCE AND MINOR REPAIR

---

---

Coolant reservoir capacity:  
0.35 L

5. Install the panel B.

EC000080

## CAUTION:

- **If coolant is not available, use distilled water or soft tap water instead. Do not use hard water or salt water since it is harmful to the engine.**
- **If water has been used instead of coolant, replace it with coolant as soon as possible, otherwise the engine may not be sufficiently cooled and the cooling system will not be protected against frost and corrosion.**
- **If water has been added to the coolant, have a Yamaha dealer check the antifreeze content of the coolant as soon as possible, otherwise the effectiveness of the coolant will be reduced.**

EW000067

## ⚠ WARNING

**Never attempt to remove the radiator cap when the engine is hot.**

## NOTE:

The radiator fan is automatically switched on or off according to the coolant temperature in the radiator. If the engine overheats, see page 6-32 for further instructions.

EAUM0034

## Air filter and V-belt case air filter elements

The air filter and the V-belt case air filter elements should be cleaned at the intervals specified in the periodic maintenance and lubrication chart. Clean both filter elements more frequently if you are riding in unusually wet or dusty areas.

# PERIODIC MAINTENANCE AND MINOR REPAIR

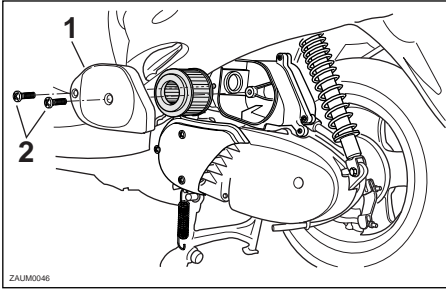

1. Air filter case cover
2. Screws

## Cleaning the air filter element

1. Place the scooter on the centerstand.
2. Remove the air filter case cover by removing the screws.
3. Pull the air filter element out.

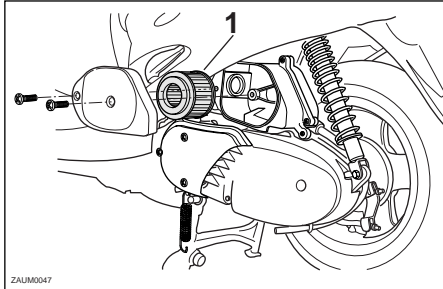

1. Air filter element

4. Lightly tap the air filter element to remove most of the dust and dirt, and then blow the remaining dirt out with compressed air.
5. Check the air filter element for damage and replace it if necessary.
6. Insert the air filter element into the air filter case.
7. Install the air filter case cover by installing the screws.

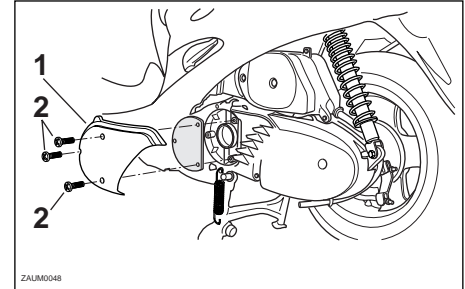

1. V-belt case air filter cover
2. Screws

## Cleaning the V-belt case air filter element

1. Remove the V-belt case air filter cover by removing the screws.

# PERIODIC MAINTENANCE AND MINOR REPAIR

EC000092

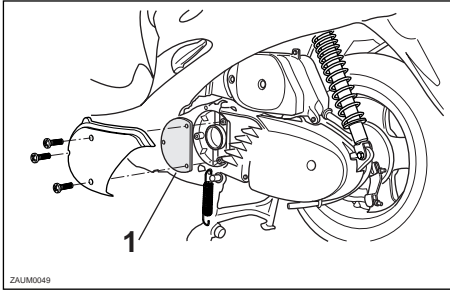

1. V-belt case air filter element

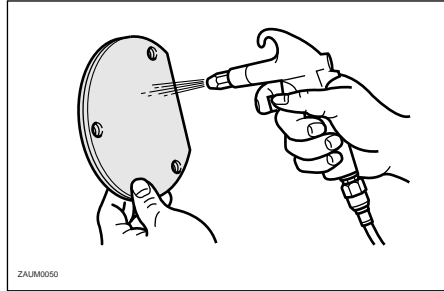

2. Remove the air filter element, and then blow out the dirt with compressed air as shown.
3. Check the air filter element for damage and replace it if necessary.
4. Install the air filter element with the colored side facing outward.
5. Install the V-belt case air filter element cover by installing the screws.

## CAUTION:

- Make sure that each filter element is properly seated in its case.
- The engine should never be operated without the filter elements installed, otherwise the piston(s) and/or cylinder(s) may become excessively worn.

EAU00631

## Adjusting the carburetor

The carburetor is an important part of the engine and requires very sophisticated adjustment. Therefore, all carburetor adjustments should be left to a Yamaha dealer, who has the necessary professional knowledge and experience.

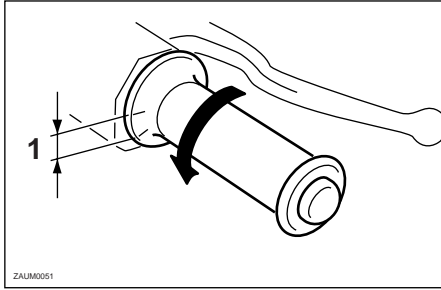

1. Throttle cable free play

EAU00635

## Adjusting the throttle cable free play

The throttle cable free play should measure 1.5 ~ 3.0 mm at the throttle grip. Periodically check the throttle cable free play and, if necessary, have a Yamaha dealer adjust it.

EAU00675

## Tires

To maximize the performance, durability, and safe operation of your scooter, note the following points regarding the specified tires.

### Tire air pressure

The tire air pressure should be checked and, if necessary, adjusted before each ride.

EW000082

### **⚠ WARNING**

The tire air pressure must be checked and adjusted on cold tires (i.e., when the temperature of the tires equals the ambient temperature). The tire air pressure must be

# PERIODIC MAINTENANCE AND MINOR REPAIR

adjusted in accordance with the riding speed and with the total weight of rider, passenger, cargo, and accessories approved for this model.

## CE-05E

Tire air pressure (measured on cold tires)		
Load*	Front	Rear
Up to 90 kg*:	180 kPa 1,8 kg/cm <sup>2</sup> 1,8 bar	200 kPa 2,0 kg/cm <sup>2</sup> 2,0 bar
90 kg ~ Maximum	200 kPa 2,0 kg/cm <sup>2</sup> 2,0 bar	220 kPa 2,2 kg/cm <sup>2</sup> 2,2 bar

\* Total weight of rider, passenger, cargo and accessories

## CE-07E

Maximum load*	310 kg
---------------	--------

\* Total weight of rider, passenger, cargo and accessories.

EW000077

## **⚠ WARNING**

Because loading has an enormous impact on the handling, braking, performance and safety characteristics of your scooter, you should keep the following precautions in mind.

**NEVER OVERLOAD THE SCOOTER!** Operation of an overloaded scooter may result in tire damage, loss of control, or severe injury. Make sure that the total weight of rider, cargo, and accessories does not exceed the specified maximum load for the vehicle.

**Do not carry along loosely packed items, which can shift during a ride. Securely pack the heaviest items close to the center of the scooter and distribute the weight evenly on both sides.**

**Adjust the suspension and tire air pressure with regard to the load. Check the tire condition and air pressure before each ride.**

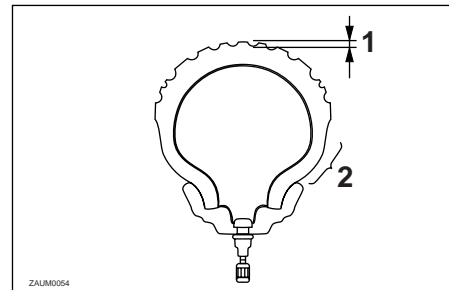

1. Tread depth
2. Side wall

## Tire inspection

The tires must be checked before each ride. If the center tread depth reaches the specified limit, if the tire has a nail or glass fragments in it, or if the sidewall is cracked, have a Yamaha dealer replace the tire immediately.

## CE-08E

Minimum tire tread depth (front and rear)	0,8 mm
---	--------

## NOTE:

The tire tread depth limits may differ from country to country. Always comply with the local regulations.



# PERIODIC MAINTENANCE AND MINOR REPAIR

EW000079

## ⚠️WARNING

Have a Yamaha dealer replace excessively worn tires. Besides being illegal, operating the scooter with excessively worn tires decreases riding stability and can lead to loss of control.

The replacement of all wheel- and brake-related parts, including the tires, should be left to a Yamaha dealer, who has the necessary professional knowledge and experience.

6

## Tire information

This scooter is equipped with tubeless tires.

### CE-10G

Front and rear

Manufacturer	Size	Type
HUTCHINSON	120/70-12	PLANET

EAU00687

## Wheels

To maximize the performance, durability, and safe operation of your scooter, note the following points regarding the specified wheels.

- The wheel rims should be checked for cracks, bends or warpage before each ride. If any damage is found, have a Yamaha dealer replace the wheel. Do not attempt even the smallest repair to the wheel. A deformed or cracked wheel must be replaced.
- The wheel should be balanced whenever either the tire or wheel has been changed or replaced. An unbalanced wheel can result in poor performance, adverse handling characteristics, and a shortened tire life.
- Ride at moderate speeds after changing a tire since the tire surface must first be «broken in» for it to develop its optimal characteristics.

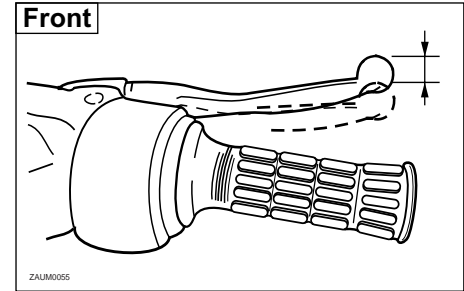

EAU00006

## Front brake adjustment

The front brake lever should have a free play of 10 ~ 20 mm at the lever end. If not, ask a Yamaha dealer to adjust it.

EW000100

## ⚠️WARNING

An incorrect brake lever free play indicates a hazardous condition in the brake system. Do not operate the scooter until the brake system has been checked or repaired by a Yamaha dealer.

# PERIODIC MAINTENANCE AND MINOR REPAIR

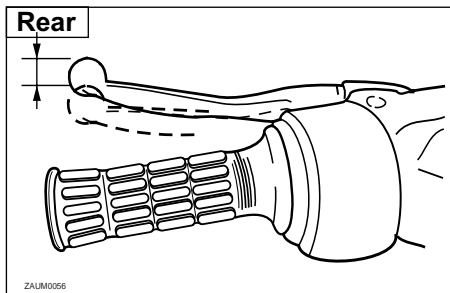

EAUM0028

## Adjusting the rear brake lever free play

The rear brake lever free play should measure 10 ~ 20 mm as shown. Periodically check the rear brake lever free play and, if necessary, adjust it as follows.

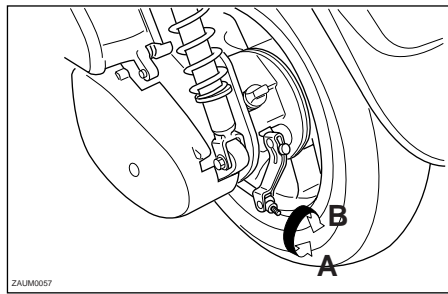

To increase the rear brake lever free play, turn the adjusting nut at the brake shoe plate in direction A. To decrease the rear brake lever free play, turn the adjusting nut in direction B.

EW000101

### **⚠ WARNING**

**If proper adjustment cannot be obtained as described, have a Yamaha dealer make this adjustment.**

EAU00720

## Checking the front brake pads and rear brake shoes

The front brake pads and the rear brake shoes must be checked for wear at the intervals specified in the periodic maintenance and lubrication chart.

# PERIODIC MAINTENANCE AND MINOR REPAIR

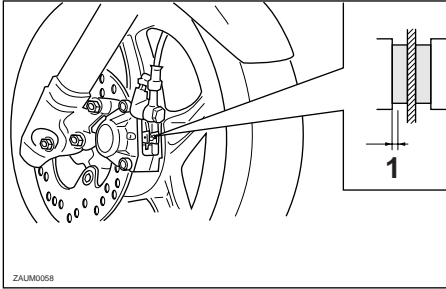

1. Wear limit

EAU01436

## Front brake pads

Check each front brake pad for damage and measure the lining thickness. If a brake pad is damaged or if the lining thickness is less than 2 mm, have a Yamaha dealer replace the brake pads as a set.

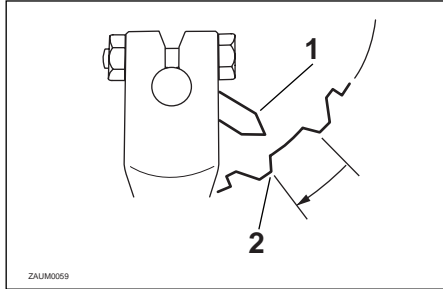

1. Wear indicator  
2. Wear limit

EAU00727

## Rear brake shoes

The rear brake is provided with a wear indicator, which allows you to check the brake shoe wear without having to disassemble the brake. To check the brake shoe wear, check the position of the wear indicator while applying the brake. If a brake shoe has worn to the point that the wear indicator reaches the wear limit line, have a Yamaha dealer replace the brake shoes as a set.

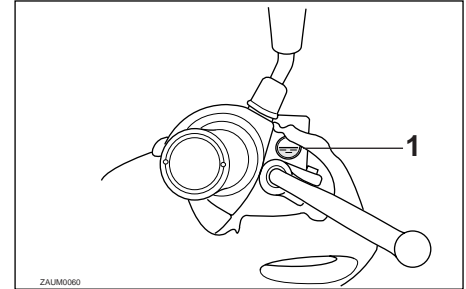

1. Minimum level

EAU00731

## Checking the brake fluid level

Insufficient brake fluid may allow air to enter the brake system, possibly causing it to become ineffective.

Before riding, check that the brake fluid is above the minimum level mark and replenish if necessary. A low brake fluid level may indicate worn brake pads and/or brake system leakage. If the brake level is low, be sure to check the brake pads for wear and the brake system for leakage.

Observe these precautions:

- When checking the fluid level, make sure that the top of the master cylinder is level by turning the handlebars.

# PERIODIC MAINTENANCE AND MINOR REPAIR

- Use only the recommended quality brake fluid, otherwise the rubber seals may deteriorate, causing leakage and poor braking performance.

Recommended brake fluid:  
DOT #3 or DOT #4

- Refill with the same type of brake fluid. Mixing fluids may result in a harmful chemical reaction and lead to poor braking performance.
- Be careful that water does not enter the master cylinder when refilling. Water will significantly lower the boiling point of the fluid and may result in vapor lock.
- Brake fluid may deteriorate painted surfaces or plastic parts. Always clean up spilled fluid immediately.
- As the brake pads wear, it is normal for the brake fluid level to gradually go down. However, if the brake fluid level goes down suddenly, have a Yamaha dealer check the cause.

## Changing the brake fluid

EAUM0008

Have a Yamaha dealer change the brake fluid at the intervals specified in the periodic maintenance and lubrication chart. In addition, have the brake hose replaced at the intervals listed below or whenever they are damaged or leaking.

Brake hose: Replace every four years.

## Checking and lubricating the cables

EAU02962

The operation of all control cables and the condition of the cables should be checked before each ride, and the cables and cable ends should be lubricated if necessary. If a cable is damaged or does not move smoothly, have a Yamaha dealer check or replace it.

Recommended lubricant:  
Engine oil

EW000112

**⚠ WARNING**  
**Damage to the outer sheath may interfere with proper cable operation and will cause the inner cable to rust. Replace a damaged cable as soon as possible to prevent unsafe conditions.**

# PERIODIC MAINTENANCE AND MINOR REPAIR

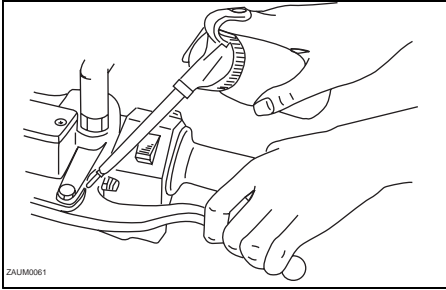

EAU00781

## Lubricating the front and rear brake levers

The pivoting points of the front and rear brake levers must be lubricated at the intervals specified in the periodic maintenance and lubrication chart.

Recommended lubricant:  
Engine oil

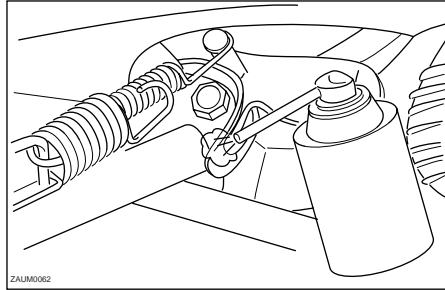

EUM0013

## Checking and lubricating the centerstand

The operation of the centerstand should be checked before each ride, and the pivots and metal-to-metal contact surfaces should be lubricated if necessary.

EW000114

### **⚠WARNING**

**If the centerstand does not move up and down smoothly, have a Yamaha dealer check or repair it.**

Recommended lubricant:  
Lithium-soap-based grease  
(all-purpose grease)

EAU02939

## Checking the front fork

The condition and operation of the front fork must be checked as follows at the intervals specified in the periodic maintenance and lubrication chart.

### To check the condition

EW000115

### **⚠WARNING**

**Securely support the scooter so that there is no danger of it falling over.**

Check the inner tubes for scratches, damage and excessive oil leakage.

# PERIODIC MAINTENANCE AND MINOR REPAIR

---

---

## To check the operation

1. Place the scooter on a level surface and hold it in an upright position.
2. While applying the front brake, push down hard on the handlebars several times to check if the front fork compresses and rebounds smoothly.

EC000098

### **CAUTION:**

**If any damage is found or the front fork does not operate smoothly, have a Yamaha dealer check or repair it.**

---

## Checking the steering

EAU00794

Worn or loose steering bearings may cause danger. Therefore, the operation of the steering must be checked as follows at the intervals specified in the periodic maintenance and lubrication chart.

1. Place a stand under the engine to raise the front wheel off the ground.

### **⚠ WARNING**

**Securely support the scooter so that there is no danger of it falling over.**

---

2. Hold the lower ends of the front fork legs and try to move them forward and backward. If any free play can be felt, have a Yamaha dealer check or repair the steering.

## Checking the wheel bearings

EAU01144

The front and rear wheel bearings must be checked at the intervals specified in the periodic maintenance and lubrication chart. If there is play in the wheel hub or if the wheel does not turn smoothly, have a Yamaha dealer check the wheel bearings.

# PERIODIC MAINTENANCE AND MINOR REPAIR

EAM0049

## Battery

A poorly maintained battery will corrode and discharge quickly. The electrolyte level, battery lead connections and breather hose routing should be checked before each ride and at the intervals specified in the periodic maintenance and lubrication chart.

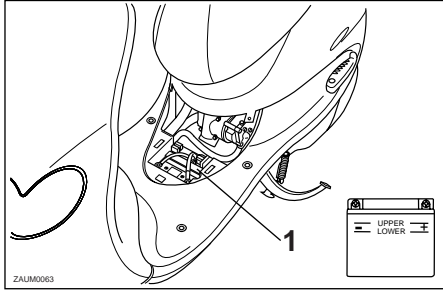

1. Battery

### To check the electrolyte level

1. Place the scooter on a level surface and hold it in an upright position.

#### **NOTE:** \_\_\_\_\_

Make sure that the scooter is positioned straight up when checking the electrolyte level.

2. Remove panel A. (See page 6-6 for panel removal and installation procedures.)
3. Check the electrolyte level in the battery.

#### **NOTE:** \_\_\_\_\_

The electrolyte should be between the minimum and maximum level marks.

4. If the electrolyte is at or below the minimum level mark, add distilled water to raise it to the maximum level mark.

EW000116

#### **⚠ WARNING** \_\_\_\_\_

**Electrolyte is poisonous and dangerous since it contains sulfuric acid, which causes severe burns. Avoid any contact with skin, eyes or clothing and always shield your eyes when working near batteries. In case of contact, administer the following FIRST AID.**

**EXTERNAL:** Flush with plenty of water.

**INTERNAL:** Drink large quantities of water or milk and immediately call a physician.

**EYES:** Flush with water for 15 minutes and seek prompt medical attention.

# PERIODIC MAINTENANCE AND MINOR REPAIR

Batteries produce explosive hydrogen gas. Therefore, keep sparks, flames, cigarettes, etc., away from the battery and provide sufficient ventilation when charging it in an enclosed space.

**KEEP THIS AND ALL BATTERIES OUT OF THE REACH OF CHILDREN.**

EC000100

## **CAUTION:**

**Use only distilled water, as tap water contains minerals that are harmful to the battery.**

5. Check and, if necessary, tighten the battery lead connections and correct the breather hose routing.

## **To store the battery**

1. If the scooter will not be used for more than one month, remove the battery, fully charge it, and then place it in a cool, dry place.
2. If the battery will be stored for more than two months, check the specific gravity of the electrolyte at least once a month and fully charge the battery whenever necessary.
3. Fully charge the battery before installation.
4. After installation, make sure that the battery leads are properly connected to the battery terminals and that the breather hose is properly routed, in good condition, and not obstructed.

EC000099

## **CAUTION:**

**If the breather hose is positioned in such a way that the frame is exposed to electrolyte or gas expelled from the battery, the frame could suffer structural and external damages.**

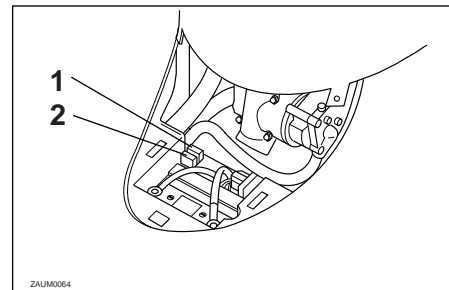

ZALM0064

1. Main fuse
2. Fan fuse

EAUM0050

## **Replacing the fuse**

The fuse holder is located behind panel A. (See page 6-6 for panel removal and installation procedures.)

If the fuse is blown, replace it as follows.

1. Turn the key to "OFF" and turn off all electrical circuits.
2. Remove the blown fuse, and then install a new fuse of the specified amperage.

Specified fuse:

Main fuse:  
20 A

Fan fuse:  
7.5 A



# PERIODIC MAINTENANCE AND MINOR REPAIR

EC000103

## CAUTION:

Do not use a fuse of a higher amperage rating than recommended to avoid causing extensive damage to the electrical system and possibly a fire.

3. Turn the key to "ON" and turn on the electrical circuits to check if the devices operate.
4. If the fuse immediately blows again, have a Yamaha dealer check the electrical system.
5. Install the panel.

6

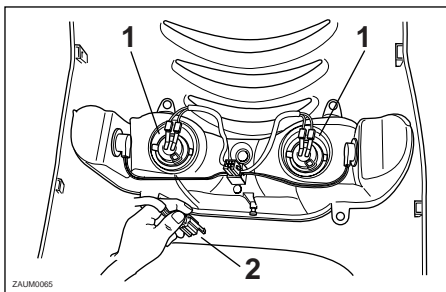

1. Bulb holder
2. Headlight connector

EAM00035

## Replacing a headlight bulb or a front turn signal light bulb

### Replacing a headlight bulb

1. Remove cowling C (See page 6-7 for cowling removal and installation procedures).
2. Remove the headlight connector.
3. Remove the headlight bulb holder by turning it 1/4 turn counterclockwise.
4. Remove the defective bulb.

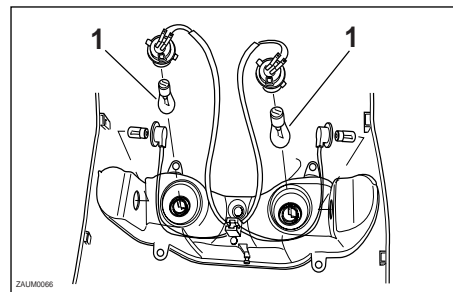

1. Bulb

EW000119

## WARNING

Headlight bulbs get very hot. Therefore, keep flammable products away from a lit headlight bulb, and do not touch the bulb until it has cooled down.

5. Place a new bulb into position, and then secure it with the bulb holder.

# PERIODIC MAINTENANCE AND MINOR REPAIR

6. Connect the headlight connector and install the cowling C.

EC000105

## CAUTION:

Do not touch the glass part of the headlight bulb to keep it free from oil, otherwise the transparency of the glass, the luminosity of the bulb, and the bulb life will be adversely affected. Thoroughly clean off any dirt and fingerprints on the headlight bulb using a cloth moistened with alcohol or thinner.

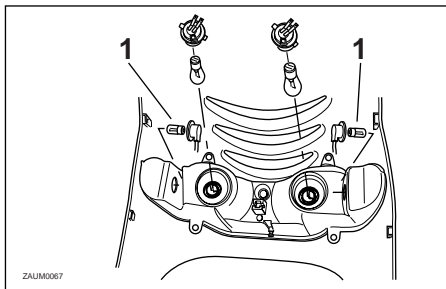

1. Bulb

## Replacing a front turn signal light bulb

1. Remove cowling C (See page 6-7 for cowling removal and installation procedures).
2. Remove the headlight connector.
3. Remove the socket (together with the turn signal light bulb) by turning it counterclockwise.
4. Remove the defective bulb.
5. Place a new bulb into position.
6. Install the socket (together with the bulb) by turning it clockwise.
7. Connect the headlight connector and install the cowling C.

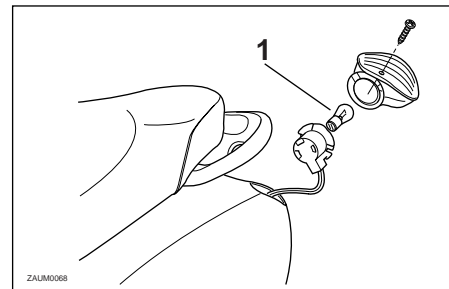

1. Bulb

## Replacing a rear turn signal light bulb

1. Remove the turn light signal unit by removing the screw.
2. Remove the socket (together with the turn signal light bulb) by turning it counterclockwise.
3. Remove the defective bulb by pulling it outward and turning it counterclockwise.
4. Insert a new bulb into the socket.
5. Install the socket (together with the bulb) by turning it clockwise.
6. Install the turn signal light unit by installing the screw.

EAUM0036

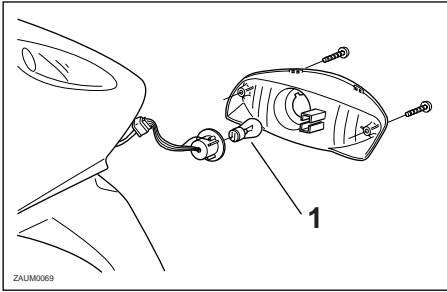

1. Bulb

EAUM0037

## Replacing taillight bulb

1. Remove the taillight by removing the screws.
2. Remove the taillight bulb holder by turning it 1/4 turn counter-clockwise.
3. Remove the defective bulb.
4. Place a new bulb into position, and then secure it with the bulb holder.
5. Place the taillight and then install the screw.

6

# PERIODIC MAINTENANCE AND MINOR REPAIR

---

EAU01008

## Troubleshooting

Although Yamaha scooters receive a thorough inspection before shipment from the factory, trouble may occur during operation. Any problem in the fuel, compression, or ignition systems, for example, can cause poor starting and loss of power.

The following troubleshooting chart represents a quick and easy procedure for checking these vital systems yourself. However, should your scooter require any repair, take it to a Yamaha dealer, whose skilled technicians have the necessary tools, experience, and know-how to service the scooter properly.

Use only genuine Yamaha replacement parts. Imitation parts may look like Yamaha parts, but they are often inferior, have a shorter service life and can lead to expensive repair bills.

# PERIODIC MAINTENANCE AND MINOR REPAIR

EAU01596

## Troubleshooting chart

### Starting problems or poor engine performance

EW000125

#### **⚠ WARNING**

**Keep away from open flames and do not smoke while checking or working on the fuel system.**

#### 1. Fuel

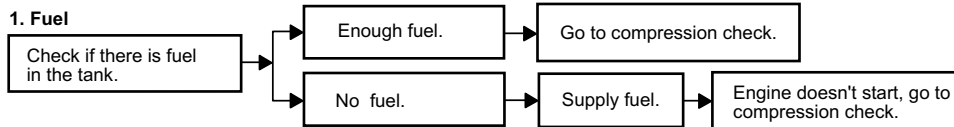

#### 2. Compression

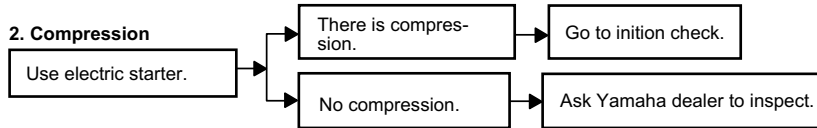

#### 3. Ignition

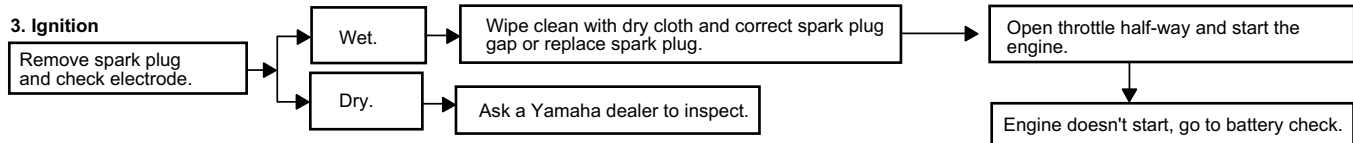

#### 4. Battery

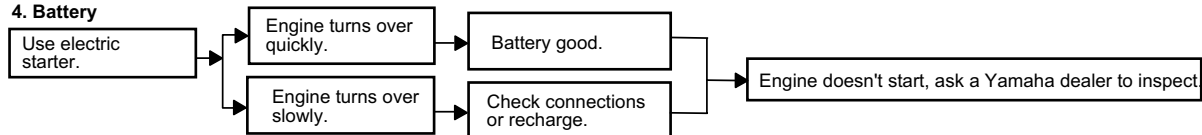

# PERIODIC MAINTENANCE AND MINOR REPAIR

## Engine overheating

EW000070

### **⚠ WARNING**

Do not remove the radiator cap when the engine and radiator are hot. Scalding hot fluid and steam may be blown out under pressure, which could cause serious injury. Be sure to wait until the engine has cooled.

After removing the radiator cap retaining bolt, place a thick rag, like a towel, over the radiator cap, and then slowly rotate the cap counterclockwise to the detent to allow any residual pressure to escape. When the hissing sound has stopped, press down on the cap while turning it counterclockwise, and then remove the cap.

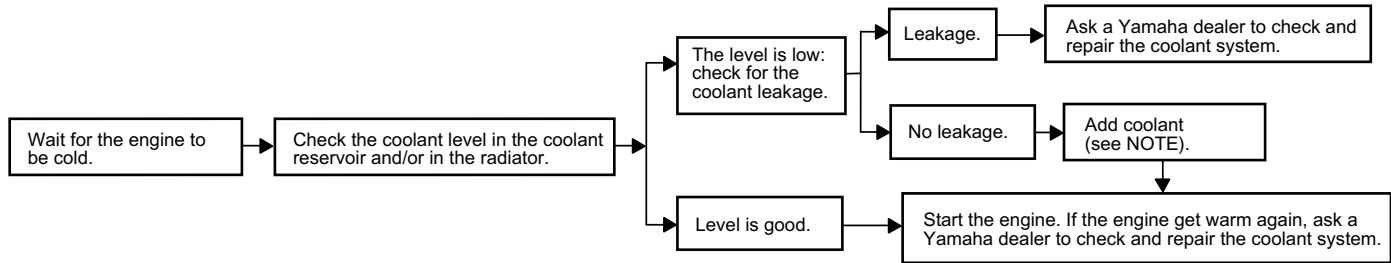

### **NOTE:**

If coolant is not available, tap water can be temporarily used instead, provided that it is changed to the recommended coolant as soon as possible.



# SCOOTER CARE AND STORAGE

---

---

Care .....	7-1
Storage.....	7-3



# SCOOTER CARE AND STORAGE

---

---

## Care

While the open design of a scooter reveals the attractiveness of the technology, it also makes it more vulnerable. Rust and corrosion can develop even if high-quality components are used. A rusty exhaust pipe may go unnoticed on a car, however, it detracts from the overall appearance of a scooter. Frequent and proper care does not only comply with the terms of the warranty, but it will also keep your scooter looking good, extend its life and optimize its performance.

## Before cleaning

1. Cover the muffler outlet with a plastic bag.
2. Make sure that all caps and covers as well as all electrical couplers and connectors, including the spark plug cap, are tightly installed.
3. Remove extremely stubborn dirt, like oil burnt onto the crankcase, with a degreasing agent and a brush, but never apply such products onto seals, gaskets and wheel axles. Always rinse the dirt and degreaser off with water.

## Cleaning

### After normal use

Remove dirt with warm water, a mild detergent, and a soft, clean sponge, and then rinse thoroughly with clean water. Use a toothbrush or bottlebrush for hard-to-reach areas. Stubborn dirt and insects will come off more easily if the area is covered with a wet cloth for a few minutes before cleaning.

ECA00011

### **CAUTION:**

- **Avoid using strong acidic wheel cleaners, especially on spoked wheels. If such products are used on hard-to-remove dirt, do not leave the cleaner on the affected area any longer than instructed. Also, thoroughly rinse the area off with water, immediately dry it, and then apply a corrosion protection spray.**
- **Improper cleaning can damage windshields, cowlings, panels and other plastic parts. Use only**

# SCOOTER CARE AND STORAGE

ECA00012

a soft, clean cloth or sponge with mild detergent and water to clean plastic.

- Do not use any harsh chemical products on plastic parts. Be sure to avoid using cloths or sponges which have been in contact with strong or abrasive cleaning products, solvent or thinner, fuel (gasoline), rust removers or inhibitors, brake fluid, antifreeze or electrolyte.
- Do not use high-pressure washers or steam-jet cleaners since they cause water seepage and deterioration in the following areas: seals (of wheel and swingarm bearings, fork and brakes), electric components (couplers, connectors, instruments, switches and lights), breather hoses and vents.
- For scooters equipped with a windshield: Do not use strong cleaners or hard sponges as they will cause dulling or scratching. Some cleaning

compounds for plastic may leave scratches on the windshield. Test the product on a small hidden part of the windshield to make sure that it does not leave any marks. If the windshield is scratched, use a quality plastic polishing compound after washing.

After riding in the rain, near the sea or on salt-sprayed roads

Since sea salt or salt sprayed on the roads during winter are extremely corrosive in combination with water, carry out the following steps after each ride in the rain, near the sea or on salt-sprayed roads.

**NOTE:** \_\_\_\_\_  
Salt sprayed on roads in the winter may remain well into spring.

1. Clean the scooter with cold water and a mild detergent after the engine has cooled down.

**CAUTION:** \_\_\_\_\_

Do not use warm water since it increases the corrosive action of the salt.

2. Apply a corrosion protection spray on all metal, including chrome- and nickel-plated, surfaces to prevent corrosion.

# SCOOTER CARE AND STORAGE

---

---

## After cleaning

1. Dry the scooter with a chamois or an absorbing cloth.
2. Use a chrome polish to shine chrome, aluminum and stainless-steel parts, including the exhaust system. (Even the thermally induced discoloring of stainless-steel exhaust systems can be removed through polishing.)
3. To prevent corrosion, it is recommended to apply a corrosion protection spray on all metal, including chrome- and nickel-plated, surfaces.
4. Use spray oil as a universal cleaner to remove any remaining dirt.
5. Touch up minor paint damage caused by stones, etc.
6. Wax all painted surfaces.
7. Let the scooter dry completely before storing or covering it.

EWA00002

## **⚠ WARNING**

**Make sure that there is no oil or wax on the brakes or tires. If necessary,**

**clean the brake discs and brake linings with a regular brake disc cleaner or acetone, and wash the tires with warm water and a mild detergent.**

**Before operating the scooter test its braking performance and cornering**

ECA00013

**CAUTION:** \_\_\_\_\_  
**Apply spray oil and wax sparingly and make sure to wipe off any excess.**

**Never apply oil or wax to any rubber and plastic parts, but treat them with a suitable care product.**

**Avoid using abrasive polishing compounds as they will wear away the paint.**

**NOTE:** \_\_\_\_\_

Consult a Yamaha dealer for advice on what products to use.

## Storage

### Short-term

Always store your scooter in a cool, dry place and, if necessary, protect it against dust with a porous cover.

ECA00015

**CAUTION:** \_\_\_\_\_  
**Storing the scooter in a poorly ventilated room or covering it with a tarp, while it is still wet, will allow water and humidity to seep in and cause rust.**

**To prevent corrosion, avoid damp cellars, stables (because of the presence of ammonia) and areas where strong chemicals are stored.**

# SCOOTER CARE AND STORAGE

## Long-term

Before storing your scooter for several months:

1. Follow all the instructions in the «Care» section of this chapter.
2. Drain the carburetor float chamber by loosening the drain bolt; this will prevent fuel deposits from building up. Pour the drained fuel into the fuel tank.
3. For scooters equipped with a fuel cock that has an “OFF” position: Turn the fuel cock lever to “OFF”.
4. Fill up the fuel tank and add fuel stabilizer (if available) to prevent the fuel tank from rusting and the fuel from deteriorating.
5. Perform the following steps to protect the cylinder, piston rings, etc. from corrosion.
  - a. Remove the spark plug cap and spark plug.
  - b. Pour a teaspoonful of engine oil into the spark plug bore.
  - c. Install the spark plug cap onto the spark plug, and then place the

- d. Turn the engine over several times with the starter. (This will coat the cylinder wall with oil.)
- e. Remove the spark plug cap from the spark plug, and then install the spark plug and the spark plug cap.

EWA00003

### **⚠ WARNING**

**To prevent damage or injury from sparking, make sure to ground the spark plug electrodes while turning the engine over.**

6. Lubricate all control cables and the pivoting points of all levers and pedals as well as of the sidestand/centerstand.
7. Check and, if necessary, correct the tire air pressure, and then lift the scooter so that both of its wheels are off the ground. Alternatively, turn the wheels a little every month

in order to prevent the tires from becoming degraded in one spot.

8. Cover the muffler outlet with a plastic bag to prevent moisture from entering it.
9. Remove the battery and fully charge it. Store it in a cool, dry place and charge it once a month. Do not store the battery in an excessively cold or warm place (less than 0°C or more than 30°C). For more information on storing the battery, see page 6-26.

### **NOTE:**

Make any necessary repairs before storing the scooter.



Specifications .....	8-1
How to use the conversion table .....	8-4

# SPECIFICATIONS

## Specifications

<b>Model</b>	<b>XN125</b>
<b>Dimensions:</b>	
Overall length	1,868 mm
Overall width	740 mm
Overall height	1,096 mm
Seat height	777 mm
Wheelbase	1,315 mm
Ground clearance	105 mm
Minimum turning radius	1,800mm
<b>Basic weight (with oil and full fuel tank):</b>	<b>123 kg</b>
<b>Engine:</b>	
Engine type	Liquid cooled 4-stroke
Cylinder arrangement	Forward inclined single cylinder
Displacement	124 cm <sup>3</sup>
Bore x Stroke	53.7 x 54.8 mm
Compression ratio	11:01
Starter system	Electric starter
Lubrication system	Wet sump

### Engine oil:

Type

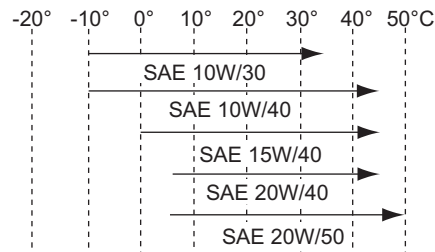

### Recommended engine oil classification

API Service SE, SF, SG type or higher

### CAUTION:

**Be sure to use motor oils that do not contain anti-friction modifiers. Passenger car motor oils (often labeled “Energy Conserving”) contain anti-friction additives which will cause clutch and/or starter clutch slippage, resulting in reduced component life and poor engine performance.**

### Capacity:

Periodic oil change	1.2 L
Total amount	1.4 L

### Final gear oil:

Type	SAE 10W30 type SE motor oil
Capacity	0.15 L

### Radiator:

Capacity (including hoses)	1.1L
----------------------------	------

# SPECIFICATIONS

<b>Air filter:</b>	Dry type element
<b>Fuel:</b>	
Type	Regular unleaded gasoline.
Fuel tank capacity	10 L
<b>Carburetor:</b>	
Type / Quantity	TK 5DS / 1
Manufacturer	TEIKEI
<b>Spark plug:</b>	
Type / Manufacturer	CR8E / NGK
Spark plug gap	0.5 ~ 0.7 mm
<b>Cluth type:</b>	Dry, centrifugal automatic
<b>Transmission:</b>	
Primary reduction system	Helical gear
Primary reduction ratio	40 / 15
Secondary reduction system	Spur gear
Secondary reduction ratio	44 / 12
Transmission type	V-belt automatic
Operation	Centrifugal automatic type

<b>Chassis:</b>		
Frame type		Steel tube backbone
Caster angle		26°
Trail		80 mm
<b>Tire:</b>		
Type		Tubeless
Size		
Front		120/70-12
Rear		120/70-12
Manufacturer / model:		
Front / Rear		HUTCHINSON / PLANET
Maximum load*		310 kg
Air pressure (cold tire):		
up to 90 kg load*		
Front		180 kPa; 1,80 kg/cm <sup>2</sup>
Rear		200 kPa; 2,00 kg/cm <sup>2</sup>
90 kg load* ~ Maximum load*		
Front		200 kPa; 2,00 kg/cm <sup>2</sup>
Rear		220 kPa; 2,20 kg/cm <sup>2</sup>

\* Load is total weight of cargo, rider, passenger and accessories.



# SPECIFICATIONS

## Wheels:

Type:

Front	Cast wheel / aluminium
Rear	Cast wheel / aluminium

Size:

Front	MT 3,50 x 12
Rear	MT 3,50 x 12

## Brakes:

Front:

Type	Single disc brake
Operation	Right hand operation
Fluid	DOT #3 or DOT#4

Rear:

Type	Drum brake
Operation	Left hand operation

## Suspension:

Front: Type

Telescopic fork

Rear: Type

Unit swing

## Shock absorber:

Front

Coil spring / Oil damper

Rear

Coil spring / Oil damper

## Wheel travel:

Front	90 mm
Rear	80 mm

## Electrical:

Ignition system	C.D.I
Charging system	Fly wheel magneto
Battery:	
Type	CB7L-B2 or YB7L-B2
Voltage, capacity	12V 8AH

## Headlight type:

Bulb

## Wattage x Quantity:

Headlight:	12V,35W/35W x 2
Position light:	12V,5W x 1
Taillight/Stop:	12V,5W x 1
Front flasher:	12V,5W/21W x 2
Rear flasher:	12V,10W x 2
Meter light:	12V,1.2W x 2
High beam indicator light:	12V,1.2W x 1
Coolant temperature warning light:	12V,1.2W x 1
Turn indicator light:	12V,1.2W x 2

## Fuse:

Main fuse	20 A
Fan fuse	7.5 A

# HOW TO USE THE CONVERSION TABLE

## HOW TO USE THE CONVERSION TABLE

EAL10001

All specification data in this manual are listed in SI and METRIC UNITS.

Use this table to convert METRIC unit data to IMPERIAL unit data.

Ex.

METRIC	MULTIPLIER	IMPERIAL
** mm	x 0.03937=	** in
2 mm	x 0.03937=	0.08 in

## CONVERSION TABLE

METRIC TO IMPERIAL			
	Metric unit	Multiplier	Imperial unit
Torque	m·kg	7.233	ft.lb
	m·kg	86.794	in.lb
	cm·kg	0.0723	ft.lb
	cm·kg	0.8679	in.lb
Weight	kg	2.205	lb
	g	0.03527	oz
Speed	km/h	0.6214	mph
Distance	km	0.6214	mi
	m	3.281	ft
	m	1.094	yd
	cm	0.3937	in
	mm	0.03937	in
Volume/ Capacity	cc (cm <sup>3</sup> )	0.03527	oz (IMP liq.)
	cc (cm <sup>3</sup> )	0.061102	cu.in
	l (litre)	0.8799	qt (IMP liq.)
	l (litre)	0.2199	gal (IMP liq.)
Miscella -neous	kg/mm	55.997	lb/in
	kg/cm <sup>2</sup>	14.2234	psi (lb/in <sup>2</sup> )
	Centrigrade	9/5 (°C)+32	Fahrenheit (°F)



Identification numbers .....	9-1
Key identification number .....	9-1
Vehicle identification number .....	9-1
Model label .....	9-2

# CONSUMER INFORMATION

## Identification numbers

EAU02944

Record the key identification number, vehicle identification number and model label information in the spaces provided below for assistance when ordering spare parts from a Yamaha dealer or for reference in case the vehicle is stolen.

1. KEY IDENTIFICATION NUMBER:

2. VEHICLE IDENTIFICATION NUMBER:

3. MODEL LABEL INFORMATION:

9

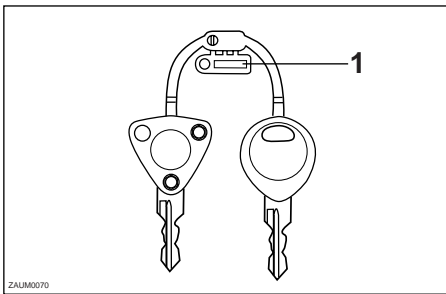

1. Key identification number

EAU01041

### Key identification number

The key identification number is stamped into the key tag.

Record this number in the space provided and use it for reference when ordering a new key.

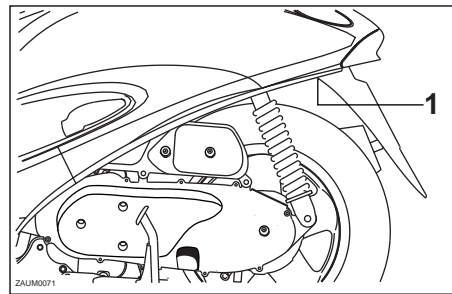

1. Vehicle identification number

EAU01044

### Vehicle identification number

The vehicle identification number is stamped into the frame.

**NOTE:** \_\_\_\_\_

The vehicle identification number is used to identify your scooter and may be used to register your scooter with the licensing authority in your area.

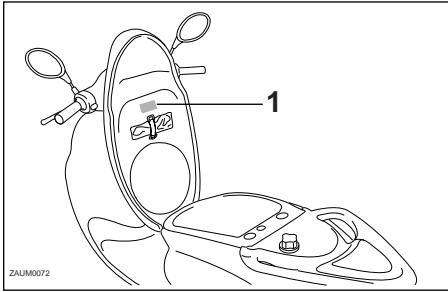

1. Model label

EAU01049

## Model label

The model label is affixed to the location shown in the figure. Record the information on this label in the space provided. This information will be needed when ordering spare parts from a Yamaha dealer.

# INDEX

## A

- Acceleration and deceleration ..... 5-2
- Adjusting the carburetor ..... 6-17
- Adjusting the rear brake  
lever free play ..... 6-20
- Adjusting the throttle cable free play ... 6-17
- Air filter and V-belt case air filter  
elements ..... 6-14

## B

- Battery ..... 6-25
- Battery voltage / Fuel gauge ..... 3-5
- Braking ..... 5-2

## C

- Care ..... 7-1
- Catalytic converter ..... 3-9
- Changing the brake fluid ..... 6-22
- Checking and lubricating the cables .... 6-22
- Checking and lubricating  
the centerstand ..... 6-23
- Checking the brake fluid level ..... 6-21
- Checking the front brake pads  
and rear brake shoes ..... 6-20
- Checking the front fork ..... 6-23
- Checking the spark plug ..... 6-8
- Checking the steering ..... 6-24
- Checking the wheel bearings ..... 6-24
- Clock ..... 3-5
- Coolant ..... 6-13
- Coolant temperature  
warning light check ..... 3-3
- Cowling C ..... 6-7

## D

- Description ..... 2-1
- Controls and instruments ..... 2-3
- Left view ..... 2-1
- Right view ..... 2-2

## E

- Engine break-in ..... 5-3
- Engine oil and oil strainer ..... 6-10
- Engine overheating ..... 6-32

## F

- Final gear oil ..... 6-12
- Front brake adjustment ..... 6-19
- Front brake lever ..... 3-7
- Fuel ..... 3-8
- Fuel tank cap ..... 3-7
- Further safe-riding points ..... 1-2

## G

- Give safety the right of way ..... 1-1

## H

- Handlebar switches ..... 3-6
- Dimmer switch ..... 3-6
- Horn switch ..... 3-6
- Light switch ..... 3-6
- Start switch ..... 3-6
- Turn signal switch ..... 3-6
- How to use the conversion table ..... 8-4

## I

- Identification numbers ..... 9-1
- Indicator lights ..... 3-2

- Coolant temperature warning light ..... 3-2
- High beam indicator light ..... 3-2
- Oil change indicator "OIL" ..... 3-2
- Turn indicator lights ..... 3-2

## K

- Key identification number ..... 9-1

## L

- Lubricating the front  
and rear brakes levers ..... 6-23
- Luggage hook ..... 3-10

## M

- Main switch / steering lock ..... 3-1
- Model label ..... 9-2

## O

- Owner's tool kit ..... 6-1

## P

- Parking ..... 5-4
- Panel A ..... 6-6
- Panel B ..... 6-6
- Periodic maintenance  
and lubrication chart ..... 6-2
- Pre-operation check list ..... 4-1

## R

- Rear brake lever ..... 3-7
- Removing and installing  
cowlings and panels ..... 6-5
- Replacing a rear turn signal  
light bulb ..... 6-28

Replacing taillight bulb ..... 6-29  
Replacing the fuse ..... 6-26  
Replacing a headlight bulb or  
a front turn signal light bulb ..... 6-27

## S

Seat ..... 3-9  
Selecting miles or kilometers ..... 3-4  
Specifications ..... 8-1  
Speedometer unit ..... 3-4  
Starting a cold engine ..... 5-1  
Starting off ..... 5-2  
Storage ..... 7-3  
Storage compartment ..... 3-9

## T

Tires ..... 6-17  
Troubleshooting ..... 6-30  
Troubleshooting chart ..... 6-31

## V

Vehicle identification number ..... 9-1

## W

Wheels ..... 6-19







PRINTED IN FRANCE  
00.04 (E)