



OWNER'S MANUAL

Diversión

XJ600S

XJ600N

4BR-28199-E8

Welcome to the Yamaha world of motorcycling!

As the owner of an XJ600S/XJ600N, you are benefiting from Yamaha's vast experience and newest technology regarding the design and manufacture of high-quality products, which have earned Yamaha a reputation for dependability.

Please take the time to read this manual thoroughly, so as to enjoy all advantages of your XJ600S/XJ600N. The owner's manual does not only instruct you in how to operate, inspect and maintain your motorcycle, but also in how to safeguard yourself and others from trouble and injury.

In addition, the many tips given in this manual will help keep your motorcycle in the best possible condition. If you have any further questions, do not hesitate to contact your Yamaha dealer.

The Yamaha team wishes you many safe and pleasant rides. So, remember to put safety first!

IMPORTANT MANUAL INFORMATION

Particularly important information is distinguished in this manual by the following notations:



The Safety Alert Symbol means **ATTENTION! BECOME ALERT! YOUR SAFETY IS INVOLVED!**



Failure to follow **WARNING** instructions could result in severe injury or death to the motorcycle operator, a bystander, or a person inspecting or repairing the motorcycle.

CAUTION:

A **CAUTION** indicates special precautions that must be taken to avoid damage to the motorcycle.

NOTE:

A **NOTE** provides key information to make procedures easier or clearer.

NOTE: _____

- This manual should be considered a permanent part of this motorcycle and should remain with it even if the motorcycle is subsequently sold.
 - Yamaha continually seeks advancements in product design and quality. Therefore, while this manual contains the most current product information available at the time of printing, there may be minor discrepancies between your motorcycle and this manual. If you have any questions concerning this manual, please consult your Yamaha dealer.
-

IMPORTANT MANUAL INFORMATION

EW000002



PLEASE READ THIS MANUAL CAREFULLY AND COMPLETELY BEFORE OPERATING THIS MOTORCYCLE.

IMPORTANT MANUAL INFORMATION

EAU03337

**XJ600S/XJ600N
OWNER'S MANUAL
© 2001 by Yamaha Motor Co., Ltd.
1st Edition, April 2001
All rights reserved.
Any reprinting or unauthorized use
without the written permission of
Yamaha Motor Co., Ltd.
is expressly prohibited.
Printed in Japan.**

1 GIVE SAFETY THE RIGHT OF WAY	1
2 DESCRIPTION	2
3 INSTRUMENT AND CONTROL FUNCTIONS	3
4 PRE-OPERATION CHECKS	4
5 OPERATION AND IMPORTANT RIDING POINTS	5
6 PERIODIC MAINTENANCE AND MINOR REPAIR	6
7 MOTORCYCLE CARE AND STORAGE	7
8 SPECIFICATIONS	8
9 CONSUMER INFORMATION	9
INDEX	



GIVE SAFETY THE RIGHT OF WAY

GIVE SAFETY THE RIGHT OF WAY 1-1



Motorcycles are fascinating vehicles, which can give you an unsurpassed feeling of power and freedom. However, they also impose certain limits, which you must accept; even the best motorcycle does not ignore the laws of physics.

Regular care and maintenance are essential for preserving value and operating condition of your motorcycle. Moreover, what is true for the motorcycle is also true for the rider: good performance depends on being in good shape. Riding under the influence of medication, drugs and alcohol is, of course, out of the question. Motorcycle riders—more than car drivers—must always be at their mental and physical best. Under the influence of even small amounts of alcohol, there is a tendency to take dangerous risks.

Protective clothing is as essential for the motorcycle rider as seat belts are for car drivers and passengers. Always wear a complete motorcycle suit (whether made of leather or tear-resistant synthetic materials with protectors), sturdy boots, motorcycle gloves and a properly fitting helmet. Optimum protective wear, however, should not encourage carelessness. Although full-coverage helmets and suits, in particular, create an illusion of total safety and protection, motorcyclists will always be vulnerable. Riders who lack critical self-control run the risk of going too fast and are apt to take chances. This is even more dangerous in wet weather. The good motorcyclist rides safely, predictably and defensively—avoiding all dangers, including those caused by others.

Enjoy your ride!

Left view (XJ600S)	2-1
Right view (XJ600S).....	2-2
Controls and instruments (XJ600S)	2-3
Left view (XJ600N)	2-4
Right view (XJ600N)	2-5
Controls and instruments (XJ600N)	2-6

Left view (XJ600S)

2

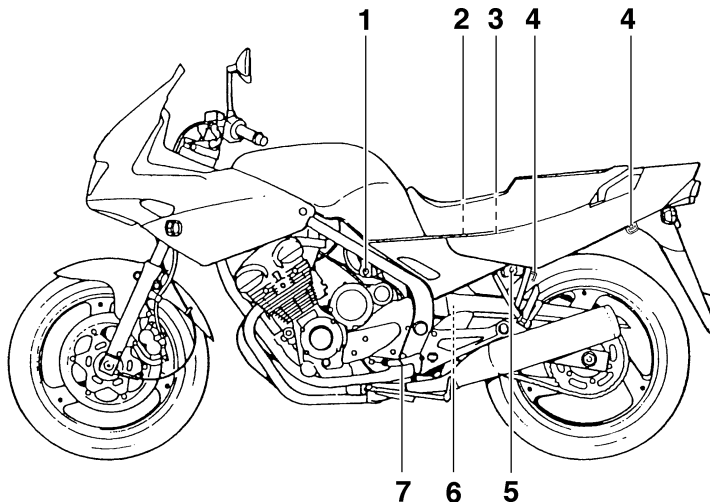

- 1. Fuel cock (page 3-11)
- 2. Helmet holder (page 3-13)
- 3. Fuse box (page 6-29)
- 4. Luggage strap holders (page 3-15)
- 5. Seat lock (page 3-12)

- 6. Shock absorber assembly
spring preload adjusting ring (page 3-14)
- 7. Shift pedal (page 3-8)

Right view (XJ600S)

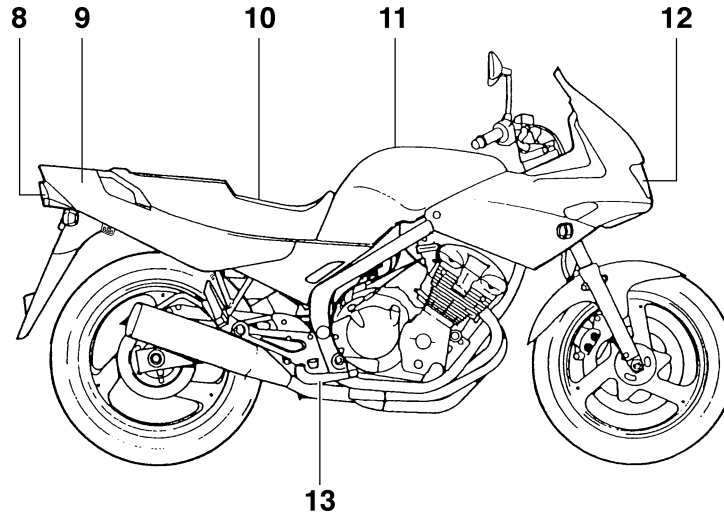

- 8. Tail/brake light
- 9. Storage compartment (page 3-14)
- 10. Seat (page 3-12)
- 11. Fuel tank (page 3-9)
- 12. Headlight (page 6-30)
- 13. Brake pedal (page 3-9)

DESCRIPTION

Controls and instruments (XJ600S)

2

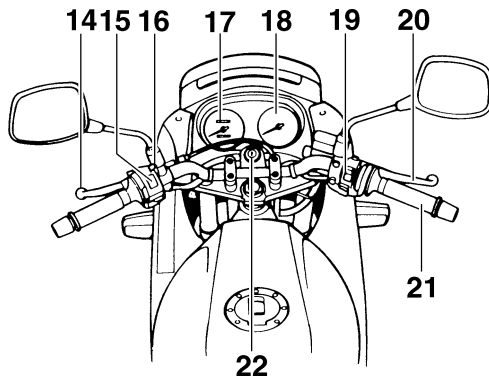

- | | |
|-------------------------------|-------------|
| 14. Clutch lever | (page 3-7) |
| 15. Left handlebar switches | (page 3-6) |
| 16. Starter (choke) lever | (page 3-12) |
| 17. Speedometer unit | (page 3-4) |
| 18. Tachometer | (page 3-5) |
| 19. Right handlebar switches | (page 3-7) |
| 20. Brake lever | (page 3-8) |
| 21. Throttle grip | (page 6-13) |
| 22. Main switch/steering lock | (page 3-1) |

Left view (XJ600N)

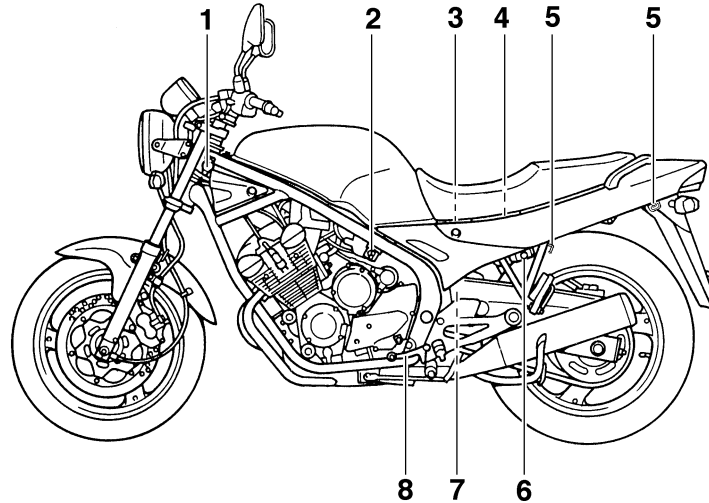

- | | | | |
|--------------------------|-------------|---|-------------|
| 1. Steering lock | (page 3-3) | 6. Seat lock | (page 3-12) |
| 2. Fuel cock | (page 3-11) | 7. Shock absorber assembly spring
preload adjusting ring | (page 3-14) |
| 3. Helmet holder | (page 3-13) | 8. Shift pedal | (page 3-8) |
| 4. Fuse box | (page 6-29) | | |
| 5. Luggage strap holders | (page 3-15) | | |

DESCRIPTION

Right view (XJ600N)

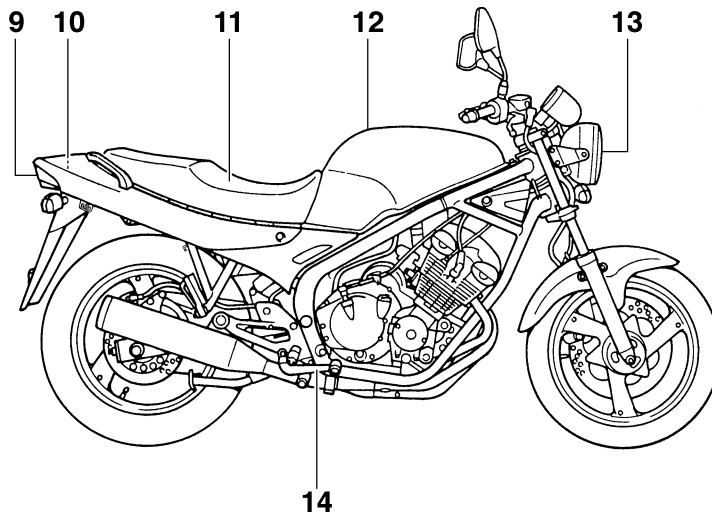

- 9. Tail/brake light
- 10. Storage compartment (page 3-13)
- 11. Seat (page 3-12)
- 12. Fuel tank (page 3-9)
- 13. Headlight (page 6-30)
- 14. Brake pedal (page 3-9)

Controls and instruments (XJ600N)

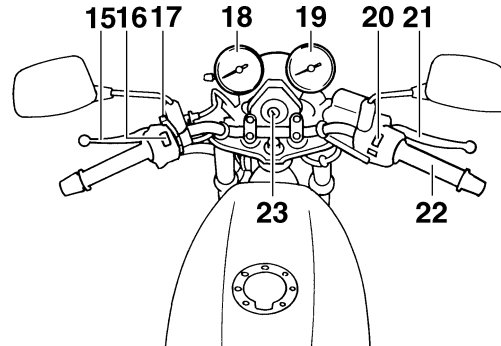

- | | |
|------------------------------|-------------|
| 15. Clutch lever | (page 3-7) |
| 16. Left handlebar switches | (page 3-6) |
| 17. Starter (choke) lever | (page 3-12) |
| 18. Speedometer unit | (page 3-5) |
| 19. Tachometer | (page 3-5) |
| 20. Right handlebar switches | (page 3-7) |
| 21. Brake lever | (page 3-8) |
| 22. Throttle grip | (page 6-13) |
| 23. Main switch | (page 3-1) |

INSTRUMENT AND CONTROL FUNCTIONS

Main switch/steering lock	3-1	Fuel	3-10
Steering lock (for XJ600N).....	3-3	Fuel tank breather hose (for Germany only)	3-11
Indicator and warning lights	3-3	Fuel cock	3-11
Speedometer unit (for XJ600S)	3-4	Starter (choke) lever	3-12
Speedometer unit (for XJ600N)	3-5	Seat	3-12
Tachometer	3-5	Helmet holders	3-13
Handlebar switches	3-6	Storage compartment	3-14
Clutch lever	3-7	Adjusting the shock absorber assembly	3-14
Shift pedal	3-8	Luggage strap holders	3-15
Brake lever	3-8	Sidestand	3-15
Brake pedal	3-9	Ignition circuit cut-off system	3-16
Fuel tank cap	3-9		

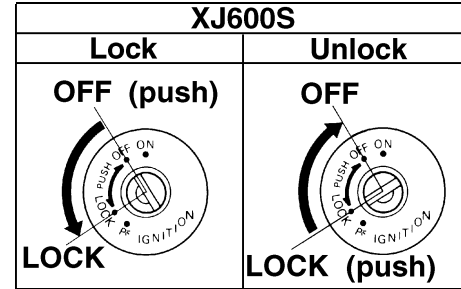
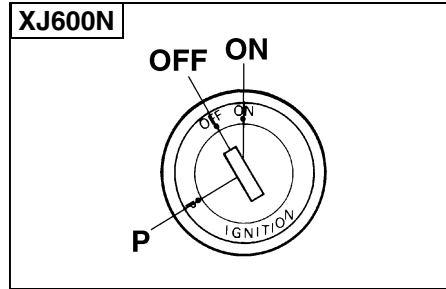
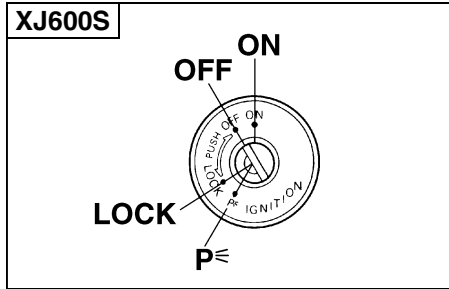

Main switch/steering lock

EAU00029

The main switch/steering lock controls the ignition and lighting systems, and is used to lock the steering. The various positions are described below.

ON

EAU00036

All electrical systems are supplied with power, and the engine can be started. The key cannot be removed.

OFF

EAU00038

All electrical systems are off. The key can be removed.

LOCK (for XJ600S)

EAU00040

The steering is locked, and all electrical systems are off. The key can be removed.

To lock the steering

1. Turn the handlebars all the way to the left.
2. Push the key in from the "OFF" position, and then turn it to "LOCK" while still pushing it.
3. Remove the key.

To unlock the steering

Push the key in, and then turn it to "OFF" while still pushing it.

INSTRUMENT AND CONTROL FUNCTIONS

EW000016

! WARNING

Never turn the key to “OFF” or “LOCK” while the motorcycle is moving, otherwise the electrical systems will be switched off, which may result in loss of control or an accident. Make sure that the motorcycle is stopped before turning the key to “OFF” or “LOCK”.

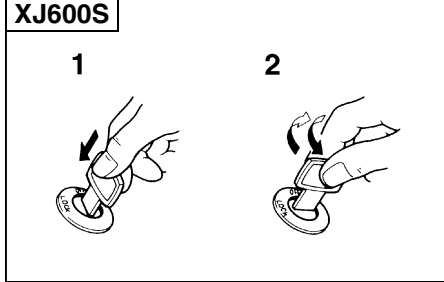

1. Push.
2. Turn.

EAU01590

P (Parking) (for XJ600S)

The steering is locked, and the taillight and auxiliary light are on, but all other electrical systems are off. The key can be removed.

The steering must be locked before the key can be turned to “P”.

ECA00043

CAUTION:

Do not use the parking position for an extended length of time, otherwise the battery may discharge.

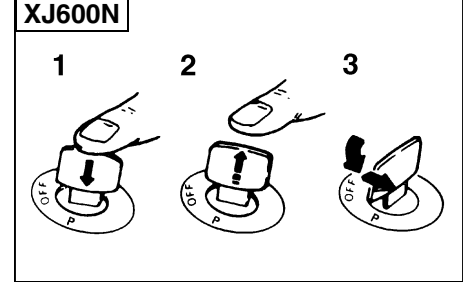

1. Push.
2. Release.
3. Turn.

EAU00055

P (Parking) (for XJ600N)

The taillight and auxiliary light are on, but all other electrical systems are off. The key can be removed.

The key must be pushed in, and then released before it can be turned to “P”.

ECA00043

CAUTION:

Do not use the parking position for an extended length of time, otherwise the battery may discharge.

INSTRUMENT AND CONTROL FUNCTIONS

3

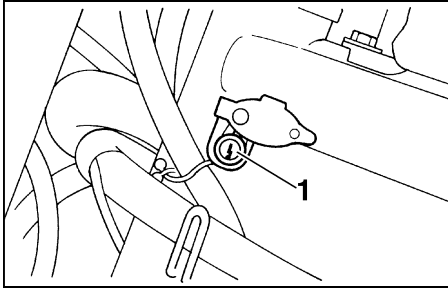

1. Steering lock

EAU02934

Steering lock (for XJ600N)





To lock the steering

1. Turn the handlebar all the way to right.
2. Open the steering lock cover, and then insert the key.
3. Turn the key 1/8 turn counter-clockwise, push it in while turning the handlebar slightly to the left, and then turn the key 1/8 turn clockwise.
4. Check that the steering is locked, remove the key, and then close the lock cover.

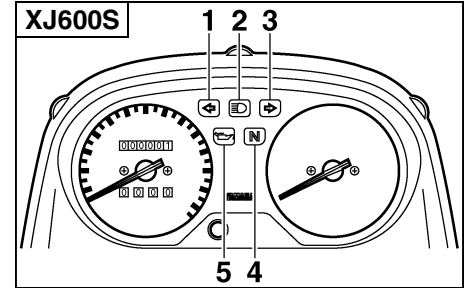
To unlock the steering

1. Open the steering lock cover, and then insert the key.
2. Push the key in, turn it 1/8 turn counterclockwise so that it moves out, and then release it.
3. Remove the key, and then close the lock cover.



1. Left turn signal indicator light “”
2. High beam indicator light “”
3. Right turn signal indicator light “”
4. Neutral indicator light “**N**”
5. Oil level warning light “”

EAU03034

Indicator and warning lights

Turn signal indicator lights “” and “”

EAU04121

The corresponding indicator light flashes when the turn signal switch is pushed to the left or right.

Neutral indicator light “**N**”

EAU00061

This indicator light comes on when the transmission is in the neutral position.

INSTRUMENT AND CONTROL FUNCTIONS

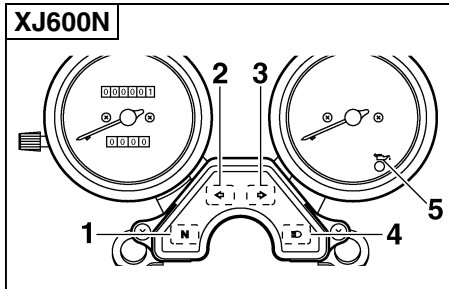

1. Neutral indicator light “N”
2. Left turn signal indicator light “←”
3. Right turn signal indicator light “→”
4. High beam indicator light “≡”
5. Oil level warning light “⚠”

EAU00063

High beam indicator light “≡”

This indicator light comes on when the high beam of the headlight is switched on.

EAU03201

Oil level warning light “⚠”

This warning light comes on when the engine oil level is low.

The electrical circuit of the warning light can be checked according to the following procedure.

1. Set the engine stop switch to “○” and turn the key to “ON”.
2. Shift the transmission into the neutral position or pull the clutch lever.
3. Push the start switch. If the warning light does not come on while pushing the start switch, have a Yamaha dealer check the electrical circuit.

NOTE:

Even if the oil level is sufficient, the warning light may flicker when riding on a slope or during sudden acceleration or deceleration, but this is not a malfunction.

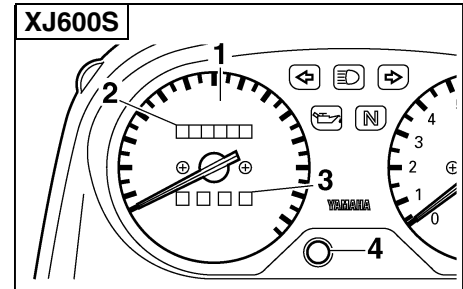

1. Speedometer
2. Odometer
3. Tripmeter
4. Tripmeter reset button

EAU00094

Speedometer unit (for XJ600S)

The speedometer unit is equipped with a speedometer, an odometer and a tripmeter. The speedometer shows riding speed. The odometer shows the total distance traveled. The tripmeter shows the distance traveled since it was last set to zero with the reset button. The tripmeter can be used to estimate the distance that can be traveled with a full tank of fuel. This information will enable you to plan future fuel stops.

INSTRUMENT AND CONTROL FUNCTIONS

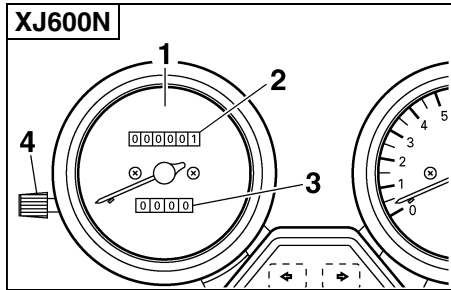

1. Speedometer
2. Odometer
3. Tripmeter
4. Tripmeter reset knob

EAU00095

Speedometer unit (for XJ600N)

The speedometer unit is equipped with a speedometer, an odometer and a tripmeter. The speedometer shows riding speed. The odometer shows the total distance traveled. The tripmeter shows the distance traveled since it was last set to zero with the reset knob. The tripmeter can be used to estimate the distance that can be traveled with a full tank of fuel. This information will enable you to plan future fuel stops.

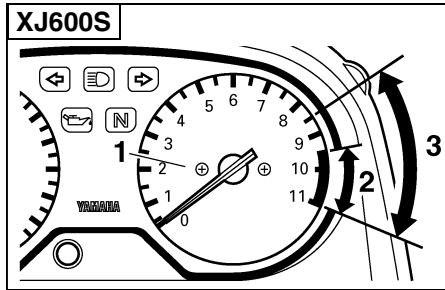

1. Tachometer
2. Tachometer red zone (except for CH, A)
3. Tachometer red zone (for CH, A)

EAU00101*

Tachometer

The electric tachometer allows the rider to monitor the engine speed and keep it within the ideal power range.

EC000003*

CAUTION:

Do not operate the engine in the tachometer red zone.

**Red zone: 9,500 r/min and above
(except for CH, A)
8,500 r/min and above
(for CH, A)**

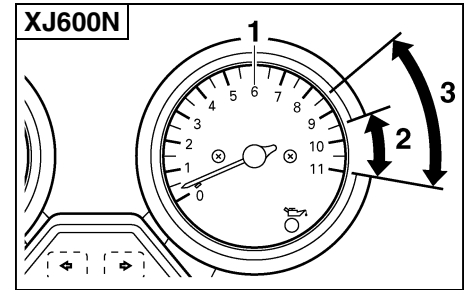

1. Tachometer
2. Tachometer red zone (except for CH, A)
3. Tachometer red zone (for CH, A)

INSTRUMENT AND CONTROL FUNCTIONS

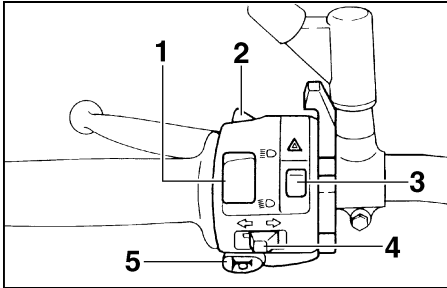

1. Dimmer switch “/ ”
2. Pass switch “PASS”
3. Hazard switch “”
4. Turn signal switch “/ ”
5. Horn switch “”

EAU00118

Handlebar switches

EAU00120

Pass switch “PASS”

Press this switch to flash the headlight.

EAU03888

Dimmer switch “/ ”

Set this switch to “” for the high beam and to “” for the low beam.

EAU03826

Hazard switch “”

With the key in the “ON” or “P” position, use this switch to turn on the hazard light (simultaneous flashing of all turn signal lights).

The hazard light is used in case of an emergency or to warn other drivers when your motorcycle is stopped where it might be a traffic hazard.

EC000006

CAUTION:

Do not use the hazard light for an extended length of time, otherwise the battery may discharge.

EAU03889

Turn signal switch “/ ”

To signal a right-hand turn, push this switch to “”. To signal a left-hand turn, push this switch to “”. When released, the switch returns to the center position. To cancel the turn signal lights, push the switch in after it has returned to the center position.

3

EAU00129

Horn switch “”

Press this switch to sound the horn.

INSTRUMENT AND CONTROL FUNCTIONS

3

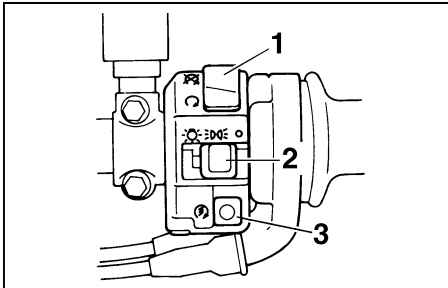

1. Engine stop switch “○/⊗”
2. Light switch “☀/≡▷▷≡/●”
3. Start switch “⊗”

EAU03890

Engine stop switch “○/⊗”

Set this switch to “○” before starting the engine. Set this switch to “⊗” to stop the engine in case of an emergency, such as when the motorcycle overturns or when the throttle cable is stuck.

EAU03898

Light switch “☀/≡▷▷≡/●”

Set this switch to “≡▷▷≡” to turn on the auxiliary light, meter lighting and tail-light. Set the switch to “☀” to turn on the headlight also. Set the switch to “●” to turn off all the lights.

EAU00143

Start switch “⊗”

Push this switch to crank the engine with the starter.

EC000005

CAUTION:

See page 5-1 for starting instructions prior to starting the engine.

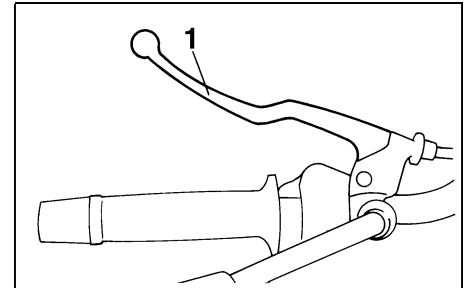

1. Clutch lever

EAU00152

Clutch lever

The clutch lever is located at the left handlebar grip. To disengage the clutch, pull the lever toward the handlebar grip. To engage the clutch, release the lever. The lever should be pulled rapidly and released slowly for smooth clutch operation.

The clutch lever is equipped with a clutch switch, which is part of the ignition circuit cut-off system. (See page 3-16 for an explanation of the ignition circuit cut-off system.)

INSTRUMENT AND CONTROL FUNCTIONS

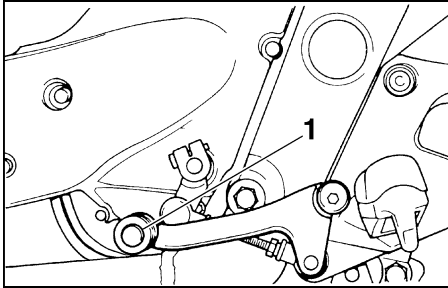

1. Shift pedal

EAU00157

Shift pedal

The shift pedal is located on the left side of the engine and is used in combination with the clutch lever when shifting the gears of the 6-speed constant-mesh transmission equipped on this motorcycle.

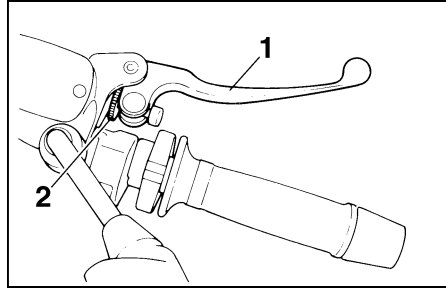

1. Brake lever
2. Brake lever position adjusting nut

EAU00160

Brake lever

The brake lever is located at the right handlebar grip. To apply the front brake, pull the lever toward the handlebar grip.

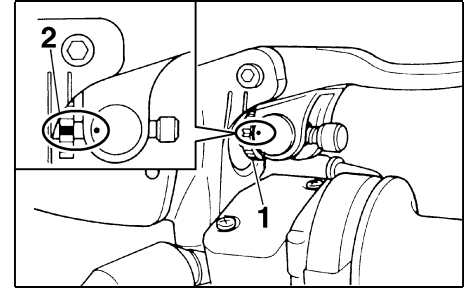

1. Brake lever position adjusting nut
2. Properly aligned marks

The brake lever is equipped with a position adjusting nut. To adjust the distance between the brake lever and the handlebar grip, turn the adjusting nut while holding the lever pushed away from the handlebar grip. Make sure that the mark “■” on the adjusting nut is aligned with the mark “●” on the brake lever.

INSTRUMENT AND CONTROL FUNCTIONS

3

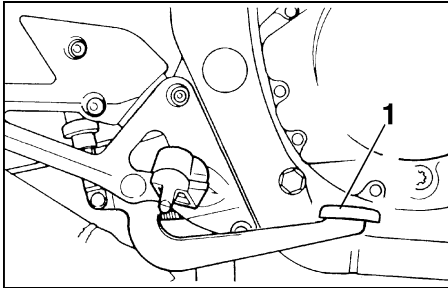

1. Brake pedal

EAU00162

Brake pedal

The brake pedal is on the right side of the motorcycle. To apply the rear brake, press down on the brake pedal.

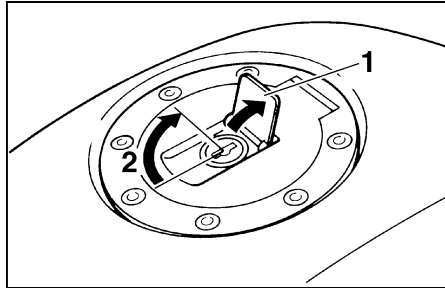

1. Fuel tank cap lock cover
2. Unlock.

EAU02935

Fuel tank cap

To open the fuel tank cap

Open the fuel tank cap lock cover, insert the key into the lock, and then turn it 1/4 turn clockwise. The lock will be released and the fuel tank cap can be opened.

To close the fuel tank cap

1. Push the fuel tank cap into position with the key inserted in the lock.
2. Turn the key counterclockwise to the original position, remove it, and then close the lock cover.

NOTE:

The fuel tank cap cannot be closed unless the key is in the lock. In addition, the key cannot be removed if the cap is not properly closed and locked.

EWA00025

! WARNING

Make sure that the fuel tank cap is properly closed before riding.

INSTRUMENT AND CONTROL FUNCTIONS

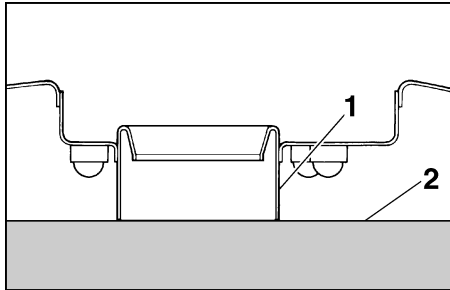

1. Fuel tank filler tube
2. Fuel level

EAU03753

Fuel

Make sure that there is sufficient fuel in the tank. Fill the fuel tank to the bottom of the filler tube as shown.

EW000130

WARNING

- Do not overfill the fuel tank, otherwise it may overflow when the fuel warms up and expands.
- Avoid spilling fuel on the hot engine.

EAU00185

CAUTION: Immediately wipe off spilled fuel with a clean, dry, soft cloth, since fuel may deteriorate painted surfaces or plastic parts.

EAU04202

Recommended fuel:
REGULAR UNLEADED
GASOLINE ONLY

Fuel tank capacity:

Total amount:

17.0 L

Reserve amount:

3.5 L

ECA00102

CAUTION: Use only unleaded gasoline. The use of leaded gasoline will cause severe damage to the engine internal parts such as valves, piston rings, exhaust system, etc.

Your Yamaha engine has been designed to use regular unleaded gasoline with a research octane number of 91 or higher. If knocking (or pinging) occurs, use a gasoline of a different brand or premium unleaded fuel. Use of unleaded fuel will extend spark plug life and reduce maintenance costs.

INSTRUMENT AND CONTROL FUNCTIONS

3

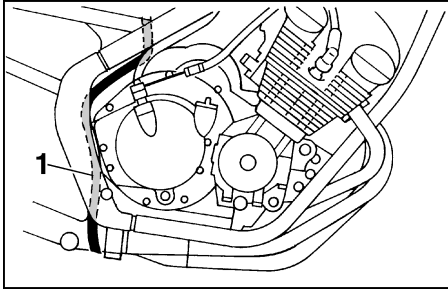

1. Fuel tank breather hose

EAU00196

Fuel tank breather hose (for Germany only)

Before operating the motorcycle:

- Check the fuel tank breather hose connection.
- Check the fuel tank breather hose for cracks or damage, and replace it if damaged.
- Make sure that the end of the fuel tank breather hose is not blocked and clean it if necessary.

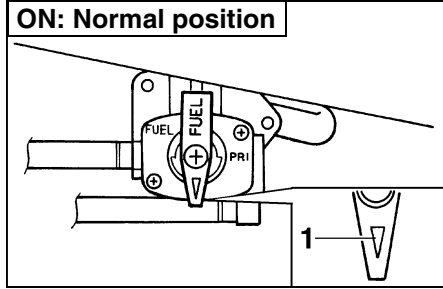

1. Arrow mark positioned over "ON"

EAU00207

Fuel cock

The fuel cock supplies fuel from the tank to the carburetors while also filtering it.

The fuel cock lever positions are explained as follows and shown in the illustrations.

ON

With the fuel cock lever in this position, fuel flows to the carburetors when the engine is running. Turn the fuel cock lever to this position when starting the engine and riding.

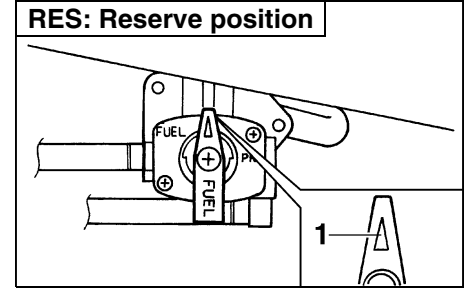

1. Arrow mark positioned over "RES"

RES

This indicates reserve. With the fuel cock lever in this position, the fuel reserve is made available. Quickly turn the fuel cock lever to this position if you run out of fuel while riding, otherwise the engine may stall and will have to be primed (see "PRI"). After turning the fuel cock lever to "RES", refuel as soon as possible and be sure to turn the fuel cock lever back to "ON"!

INSTRUMENT AND CONTROL FUNCTIONS

PRI: Prime position

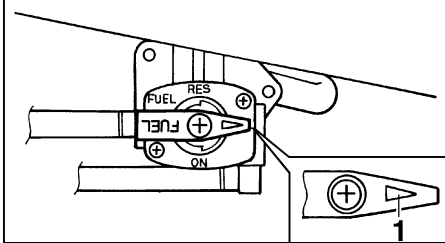

1. Arrow mark positioned over "PRI"

PRI

This indicates prime. With the fuel cock lever in this position, the engine can be "primed". Turn the fuel cock lever to this position when the engine has been allowed to run out of fuel. This sends fuel directly to the carburetors, which will make starting easier. After the engine has started, be sure to turn the lever to "ON" (or "RES" if you have not refueled yet).

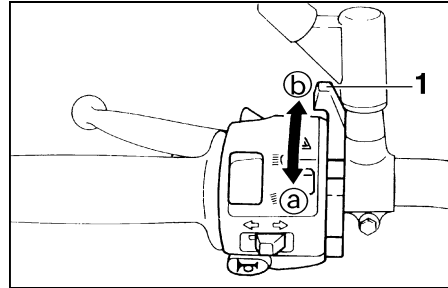

1. Starter (choke) lever "a"

Starter (choke) lever "a"

EAU03839

Starting a cold engine requires a richer air-fuel mixture, which is supplied by the starter (choke). Move the lever in direction **a** to turn on the starter (choke). Move the lever in direction **b** to turn off the starter (choke).

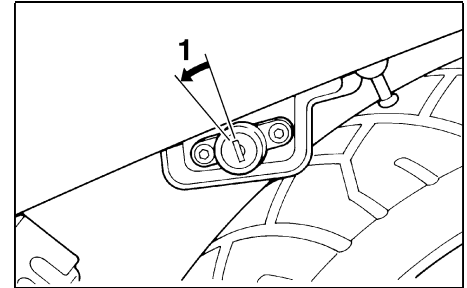

1. Unlock.

Seat

EAU02925

To remove the seat

Insert the key into the seat lock, turn it counterclockwise, and then pull the seat off.

INSTRUMENT AND CONTROL FUNCTIONS

EWA00015

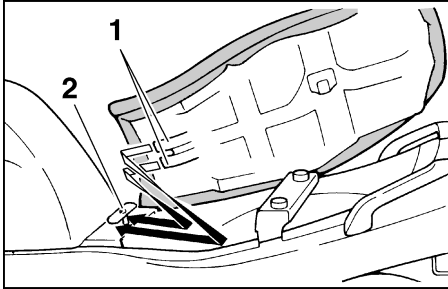

1. Projection (× 2)
2. Seat holder

To install the seat

Insert the projections on the front of the seat into the seat holder, push the rear of the seat down to lock it in place, and then remove the key.

NOTE:

Make sure that the seat is properly secured before riding.

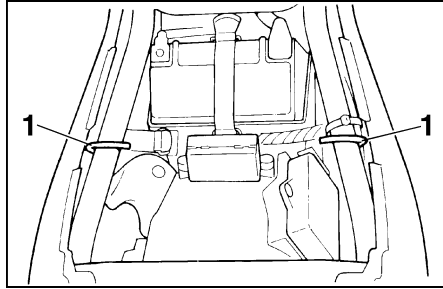

1. Helmet holder (× 2)

EAU02936

Helmet holders

The helmet holders are located under the seat.

To secure a helmet to a helmet holder

1. Remove the seat. (See page 3-12 for seat removal and installation procedures.)
2. Attach the helmet to the helmet holder, and then securely install the seat.

⚠ WARNING

Never ride with a helmet attached to a helmet holder, since the helmet may hit objects, causing loss of control and possibly an accident.

To release a helmet from a helmet holder

Remove the seat, remove the helmet from the helmet holder, and then install the seat.

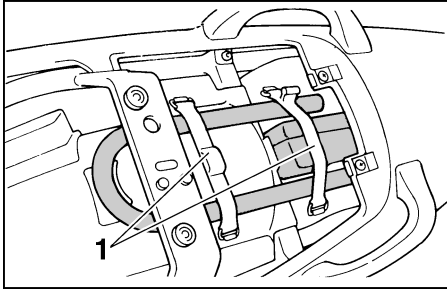

1. Strap for U-LOCK (× 2)

EAU01688

Storage compartment

This storage compartment is designed to hold a genuine Yamaha U-LOCK. (Other locks may not fit.) When placing a U-LOCK in the storage compartment, securely fasten it with the straps. When the U-LOCK is not in the storage compartment, be sure to secure the straps to prevent losing them.

When storing the owner's manual or other documents in the storage compartment, be sure to wrap them in a plastic bag so that they will not get wet. When washing the motorcycle, be careful not to let any water enter the storage compartment.

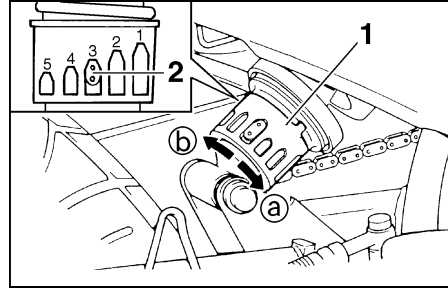

1. Spring preload adjusting ring
2. Position indicator

EAU00295

Adjusting the shock absorber assembly

This shock absorber assembly is equipped with a spring preload adjusting ring.

EC000015

CAUTION:

Never attempt to turn an adjusting mechanism beyond the maximum or minimum settings.

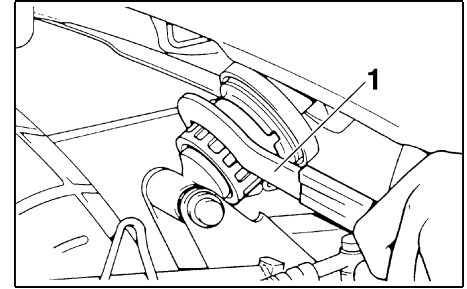

1. Special wrench

Adjust the spring preload as follows.

To increase the spring preload and thereby harden the suspension, turn the adjusting ring in direction (a). To decrease the spring preload and thereby soften the suspension, turn the adjusting ring in direction (b).

NOTE:

Align the appropriate notch in the adjusting ring with the position indicator on the shock absorber.

	Setting
Minimum (soft)	1
Standard	3
Maximum (hard)	7

INSTRUMENT AND CONTROL FUNCTIONS

EAU00315

⚠ WARNING

This shock absorber contains highly pressurized nitrogen gas. For proper handling, read and understand the following information before handling the shock absorber. The manufacturer cannot be held responsible for property damage or personal injury that may result from improper handling.

- Do not tamper with or attempt to open the gas cylinder.
- Do not subject the shock absorber to an open flame or other high heat sources, otherwise it may explode due to excessive gas pressure.
- Do not deform or damage the gas cylinder in any way, as this will result in poor damping performance.
- Always have a Yamaha dealer service the shock absorber.

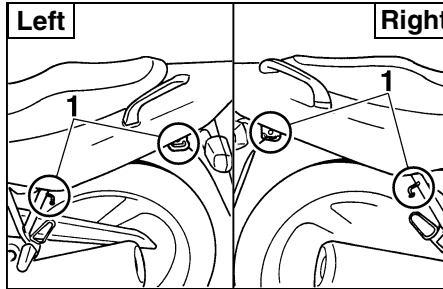

1. Luggage strap holder (x 4)

EAU01398

Luggage strap holders

There are four luggage strap holders: one on each passenger footrest bracket and one below each side of the seat.

EAU00330

Sidestand

The sidestand is located on the left side of the frame. Raise the sidestand or lower it with your foot while holding the motorcycle upright.

NOTE:

The built-in sidestand switch is part of the ignition circuit cut-off system, which cuts the ignition in certain situations. (See further down for an explanation of the ignition circuit cut-off system.)

EW000044

EAU03741

EW000046

WARNING

The motorcycle must not be ridden with the sidestand down, or if the sidestand cannot be properly moved up (or does not stay up), otherwise the sidestand could contact the ground and distract the operator, resulting in a possible loss of control. Yamaha's ignition circuit cut-off system has been designed to assist the operator in fulfilling the responsibility of raising the sidestand before starting off. Therefore, check this system regularly as described below and have a Yamaha dealer repair it if it does not function properly.

Ignition circuit cut-off system

The ignition circuit cut-off system (comprising the sidestand switch, clutch switch and neutral switch) has the following functions.

- It prevents starting when the transmission is in gear and the sidestand is up, but the clutch lever is not pulled.
- It prevents starting when the transmission is in gear and the clutch lever is pulled, but the sidestand is still down.
- It cuts the running engine when the transmission is in gear and the sidestand is moved down.

Periodically check the operation of the ignition circuit cut-off system according to the following procedure.

WARNING

- The vehicle must be placed on the centerstand during this inspection.
- If a malfunction is noted, have a Yamaha dealer check the system before riding.

INSTRUMENT AND CONTROL FUNCTIONS

3

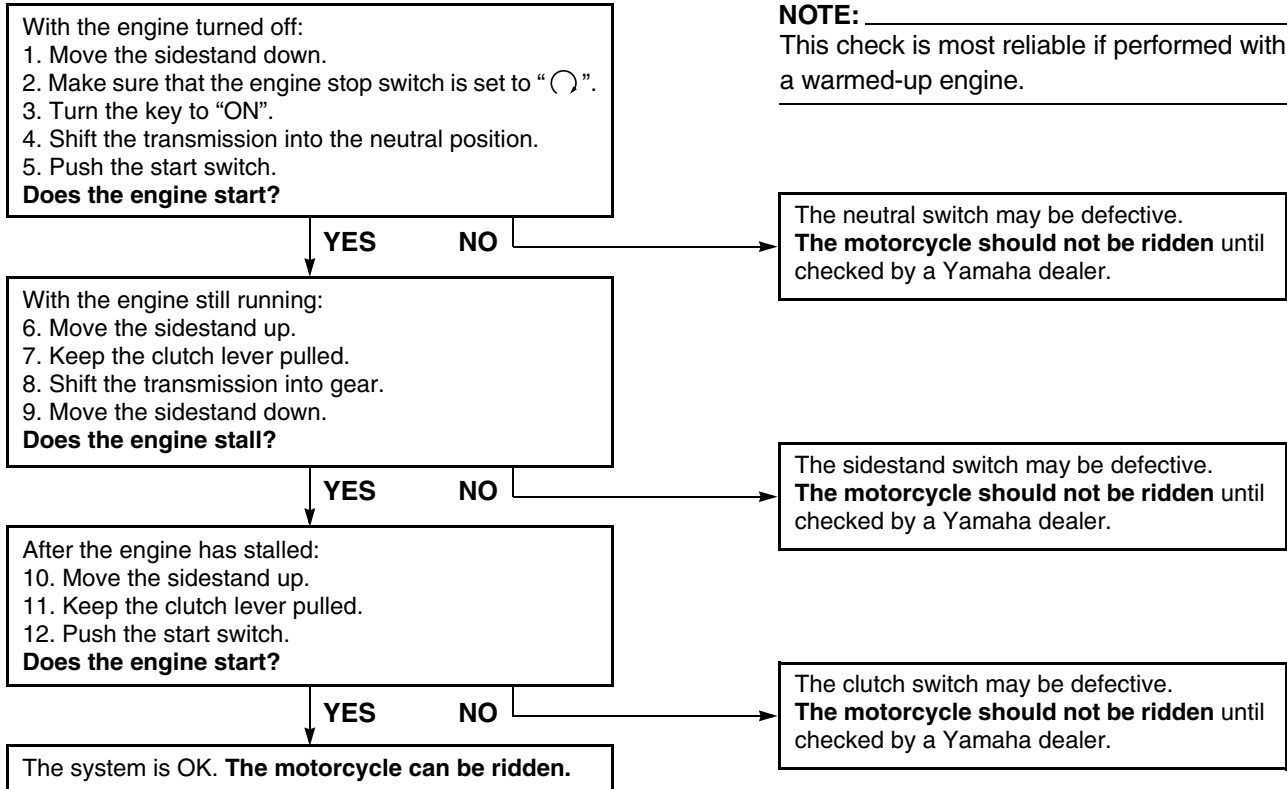

Pre-operation check list 4-1

PRE-OPERATION CHECKS

The condition of a vehicle is the owner's responsibility. Vital components can start to deteriorate quickly and unexpectedly, even if the vehicle remains unused (for example, as a result of exposure to the elements). Any damage, fluid leakage or loss of tire air pressure could have serious consequences. Therefore, it is very important, in addition to a thorough visual inspection, to check the following points before each ride.

Pre-operation check list

ITEM	CHECKS	PAGE
Front brake	<ul style="list-style-type: none">• Check operation, fluid level and fluid leakage.• Fill with DOT 4 brake fluid if necessary.	6-19-6-21
Rear brake		6-18-6-21
Clutch	<ul style="list-style-type: none">• Check operation, condition and free play.• Adjust if necessary.	6-17-6-18
Throttle grip and housing	<ul style="list-style-type: none">• Make sure that operation is smooth.• Check free play.• If necessary, have Yamaha dealer make adjustment or lubricate.	6-13, 6-24
Engine oil	<ul style="list-style-type: none">• Check oil level.• Fill with oil if necessary.	6-7-6-10
Drive chain	<ul style="list-style-type: none">• Check chain slack and condition.• Adjust if necessary.	6-21-6-23
Wheels and tires	<ul style="list-style-type: none">• Check tire pressure, wear and damage.	6-14-6-17
Control and meter cables	<ul style="list-style-type: none">• Check smooth operation.• Lubricate if necessary.	6-23
Brake and shift pedal shafts	<ul style="list-style-type: none">• Check smooth operation.• Lubricate if necessary.	6-24
Brake and clutch lever pivots	<ul style="list-style-type: none">• Check smooth operation.• Lubricate if necessary.	6-25
Center and sidestand pivots	<ul style="list-style-type: none">• Check smooth operation.• Lubricate if necessary.	6-25

PRE-OPERATION CHECKS

ITEM	CHECKS	PAGE
Chassis fasteners	<ul style="list-style-type: none">• Make sure that all nuts, bolts and screws are properly tightened.• Tighten if necessary.	—
Fuel	<ul style="list-style-type: none">• Check fuel level.• Fill with fuel if necessary.	3-9-3-10
Lights, signals and switches	<ul style="list-style-type: none">• Check proper operation.	—

NOTE:

Pre-operation checks should be made each time the motorcycle is used. Such an inspection can be accomplished in a very short time; and the added safety it assures is more than worth the time involved.

EWA00033

 **WARNING**

If any item in the Pre-operation check list is not working properly, have it inspected and repaired before operating the motorcycle.

OPERATION AND IMPORTANT RIDING POINTS

Starting a cold engine	5-1
Starting a warm engine	5-2
Shifting	5-3
Recommended shift points (for Switzerland only)	5-3
Tips for reducing fuel consumption	5-4
Engine break-in	5-4
Parking	5-5

EAU00373

EAU00381*

⚠ WARNING

- Become thoroughly familiar with all operating controls and their functions before riding. Consult a Yamaha dealer regarding any control or function that you do not thoroughly understand.
- Never start the engine or operate it in a closed area for any length of time. Exhaust fumes are poisonous, and inhaling them can cause loss of consciousness and death within a short time. Always make sure that there is adequate ventilation.
- Before starting out, make sure that the sidestand is up. If the sidestand is not raised completely, it could contact the ground and distract the operator, resulting in a possible loss of control.

Starting a cold engine

In order for the ignition circuit cut-off system to enable starting, one of the following conditions must be met:

- The transmission is in the neutral position.
- The transmission is in gear with the clutch lever pulled and the sidestand up.

EW000054

⚠ WARNING

- Before starting the engine, check the function of the ignition circuit cut-off system according to the procedure described on page 3-17.
 - Never ride with the sidestand down.
1. Turn the fuel cock lever to "ON".
 2. Turn the key to "ON" and make sure that the engine stop switch is set to "○".
 3. Shift the transmission into the neutral position.

NOTE:

When the transmission is in the neutral position, the neutral indicator light should be on, otherwise have a Yamaha dealer check the electrical circuit.

4. Turn the starter (choke) on and completely close the throttle. (See page 3-12 for starter (choke) operation.)
5. Start the engine by pushing the start switch.

NOTE:

If the engine fails to start, release the start switch, wait a few seconds, and then try again. Each starting attempt should be as short as possible to preserve the battery. Do not crank the engine more than 10 seconds on any one attempt.

OPERATION AND IMPORTANT RIDING POINTS

EC000034

ECA00045

EAU01258

CAUTION:

The oil level warning light should come on when the start switch is pushed, and it should go off when the start switch is released. If the oil level warning light flickers or remains on after starting, immediately stop the engine, and then check the engine oil level and the vehicle for oil leakage. If necessary, add engine oil, and then check the warning light again. If the warning light does not come on when pushing the start switch, or if it does not go off after starting with sufficient engine oil, have a Yamaha dealer check the electrical circuit.

6. After starting the engine, move the starter (choke) lever back halfway.

CAUTION:

For maximum engine life, never accelerate hard when the engine is cold!

7. When the engine is warm, turn the starter (choke) off.

NOTE:

The engine is warm when it responds normally to the throttle with the starter (choke) turned off.

Starting a warm engine

Follow the same procedure as for starting a cold engine with the exception that the starter (choke) is not required when the engine is warm.

OPERATION AND IMPORTANT RIDING POINTS

EC000048

EAU02937

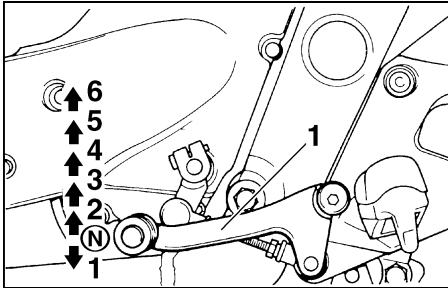

1. Shift pedal
N. Neutral position

EAU00423

5

Shifting

Shifting gears lets you control the amount of engine power available for starting off, accelerating, climbing hills, etc.

The gear positions are shown in the illustration.

NOTE:

To shift the transmission into the neutral position, press the shift pedal down repeatedly until it reaches the end of its travel, and then slightly raise it.

CAUTION:

- Even with the transmission in the neutral position, do not coast for long periods of time with the engine off, and do not tow the motorcycle for long distances. The transmission is properly lubricated only when the engine is running. Inadequate lubrication may damage the transmission.
- Always use the clutch while changing gears to avoid damaging the engine, transmission, and drive train, which are not designed to withstand the shock of forced shifting.

Recommended shift points (for Switzerland only)

The recommended shift points during acceleration are shown in the table below.

	Shift point (km/h)
1st → 2nd	20
2nd → 3rd	30
3rd → 4th	40
4th → 5th	50
5th → 6th	60

NOTE:

When shifting down two gears at a time, reduce the speed accordingly (e.g., down to 35 km/h when shifting from 5th to 3rd gear).

Tips for reducing fuel consumption

EAU00424

Fuel consumption depends largely on your riding style. Consider the following tips to reduce fuel consumption:

- Thoroughly warm up the engine.
- Turn the starter (choke) off as soon as possible.
- Shift up swiftly, and avoid high engine speeds during acceleration.
- Do not rev the engine while shifting down, and avoid high engine speeds with no load on the engine.
- Turn the engine off instead of letting it idle for an extended length of time (e.g., in traffic jams, at traffic lights or at railroad crossings).

Engine break-in

EAU00436

There is never a more important period in the life of your engine than the period between 0 and 1,000 km. For this reason, you should read the following material carefully.

Since the engine is brand new, do not put an excessive load on it for the first 1,000 km. The various parts in the engine wear and polish themselves to the correct operating clearances. During this period, prolonged full-throttle operation or any condition that might result in engine overheating must be avoided.

0–150 km

- Avoid prolonged operation above 5,000 r/min.
- After every hour of operation, stop the engine, and then let it cool for five to ten minutes.
- Vary the engine speed from time to time. Do not operate the engine at one set throttle position.

150–500 km

- Avoid prolonged operation above 6,000 r/min.
- Rev the engine freely through the gears, but do not use full throttle at any time.

OPERATION AND IMPORTANT RIDING POINTS

500–1,000 km

- Avoid prolonged full-throttle operation.
- Avoid prolonged operation above 7,000 r/min.

EC000052*

CAUTION:

After 1,000 km of operation, the engine oil must be changed and the oil filter cartridge replaced.

1,000 km and beyond

The vehicle can now be operated normally.

EC000053

CAUTION:

- Keep the engine speed out of the tachometer red zone.
- If any engine trouble should occur during the engine break-in period, immediately have a Yamaha dealer check the vehicle.

EAU00460

Parking

When parking, stop the engine, and then remove the key from the main switch.

EW000058

WARNING

- Since the engine and exhaust system can become very hot, park in a place where pedestrians or children are not likely to touch them.
- Do not park on a slope or on soft ground, otherwise the motorcycle may overturn.

PERIODIC MAINTENANCE AND MINOR REPAIR

Owner's tool kit	6-1	Checking and lubricating the throttle grip and cable	6-24
Periodic maintenance and lubrication chart	6-2	Checking and lubricating the brake and shift pedals	6-24
Removing and installing the panel	6-5	Checking and lubricating the brake and clutch levers	6-25
Checking the spark plugs	6-6	Checking and lubricating the centerstand and sidestand	6-25
Engine oil and oil filter cartridge	6-7	Lubricating the rear suspension	6-25
Cleaning the air filter element	6-10	Checking the front fork	6-26
Adjusting the carburetors	6-12	Checking the steering	6-26
Adjusting the engine idling speed	6-13	Checking the wheel bearings	6-27
Adjusting the throttle cable free play	6-13	Battery	6-27
Adjusting the valve clearance	6-14	Replacing the fuses	6-29
Tires	6-14	Replacing the headlight bulb (for XJ600S).....	6-30
Cast wheels	6-17	Replacing the headlight bulb (for XJ600N)	6-31
Adjusting the clutch lever free play	6-17	Front wheel	6-33
Adjusting the brake pedal position	6-18	Rear wheel	6-35
Adjusting the rear brake light switch	6-19	Troubleshooting	6-36
Checking the front and rear brake pads	6-19	Troubleshooting chart	6-37
Checking the brake fluid level	6-20		
Changing the brake fluid	6-21		
Drive chain slack	6-21		
Lubricating the drive chain	6-23		
Checking and lubricating the cables	6-23		

EAU00464

Safety is an obligation of the owner. Periodic inspection, adjustment and lubrication will keep your vehicle in the safest and most efficient condition possible. The most important points of inspection, adjustment, and lubrication are explained on the following pages. The intervals given in the periodic maintenance and lubrication chart should be simply considered as a general guide under normal riding conditions. However, **DEPENDING ON THE WEATHER, TERRAIN, GEOGRAPHICAL LOCATION, AND INDIVIDUAL USE, THE MAINTENANCE INTERVALS MAY NEED TO BE SHORTENED.**

EW000060

⚠ WARNING

If you are not familiar with motorcycle maintenance work, have a Yamaha dealer do it for you.

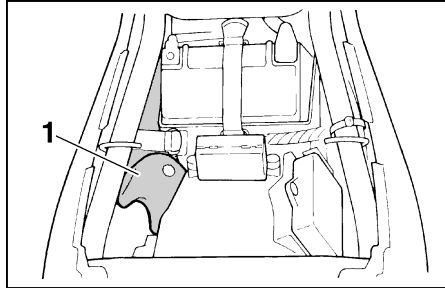

1. Owner's tool kit

EAU00469

Owner's tool kit

The service information included in this manual and the tools provided in the owner's tool kit are intended to assist you in the performance of preventive maintenance and minor repairs. However, additional tools such as a torque wrench may be necessary to perform certain maintenance work correctly.

NOTE:

If you do not have the tools or experience required for a particular job, have a Yamaha dealer perform it for you.

EW000063

⚠ WARNING

Modifications not approved by Yamaha may cause loss of performance and render the vehicle unsafe for use. Consult a Yamaha dealer before attempting any changes.

PERIODIC MAINTENANCE AND MINOR REPAIR

EAU03685

Periodic maintenance and lubrication chart

NOTE:

- The annual checks must be performed every year, except if a kilometer-based maintenance is performed instead.
- From 50,000 km, repeat the maintenance intervals starting from 10,000 km.
- Items marked with an asterisk should be performed by a Yamaha dealer as they require special tools, data and technical skills.

NO.	ITEM	CHECK OR MAINTENANCE JOB	ODOMETER READING (×1,000 km)					Annual check
			1	10	20	30	40	
1	* Fuel line	• Check fuel hoses and vacuum hose for cracks or damage.		√	√	√	√	√
2	* Fuel filter	• Check condition.			√		√	
3	Spark plugs	• Check condition. • Clean and regap.		√		√		
		• Replace.			√		√	
4	* Valves	• Check valve clearance. • Adjust.	Every 20,000 km					
5	Air filter element	• Clean.		√		√		
		• Replace.			√		√	
6	Clutch	• Check operation. • Adjust.	√	√	√	√	√	
7	* Front brake	• Check operation, fluid level and vehicle for fluid leakage. (See NOTE on page 6-4.)	√	√	√	√	√	√
		• Replace brake pads.	Whenever worn to the limit					
8	* Rear brake	• Check operation, fluid level and vehicle for fluid leakage. (See NOTE on page 6-4.)	√	√	√	√	√	√
		• Replace brake pads.	Whenever worn to the limit					

PERIODIC MAINTENANCE AND MINOR REPAIR

NO.	ITEM	CHECK OR MAINTENANCE JOB	ODOMETER READING (×1,000 km)					Annual check
			1	10	20	30	40	
9	* Brake hoses	• Check for cracks or damage.		√	√	√	√	√
		• Replace. (See NOTE on page 6-4.)	Every 4 years					
10	* Wheels	• Check runout and for damage.		√	√	√	√	
11	* Tires	• Check tread depth and for damage. • Replace if necessary. • Check air pressure. • Correct if necessary.		√	√	√	√	√
12	* Wheel bearings	• Check bearing for looseness or damage.		√	√	√	√	
13	* Swingarm	• Check operation and for excessive play.		√	√	√	√	
		• Lubricate with lithium-soap-based grease.	Every 50,000 km					
14	Drive chain	• Check chain slack. • Make sure that the rear wheel is properly aligned. • Clean and lubricate.	Every 1,000 km and after washing the motorcycle or riding in the rain.					
15	* Steering bearings	• Check bearing play and steering for roughness.	√	√	√	√	√	
		• Lubricate with lithium-soap-based grease	Every 20,000 km					
16	* Chassis fasteners	• Make sure that all nuts, bolts and screws are properly tightened.		√	√	√	√	√
17	Sidestand/centerstand	• Check operation. • Lubricate.		√	√	√	√	√
18	* Sidestand switch	• Check operation.	√	√	√	√	√	√
19	* Front fork	• Check operation and for oil leakage.		√	√	√	√	
20	* Shock absorber assembly	• Check operation and shock absorber for oil leakage.		√	√	√	√	
21	* Rear suspension relay arm and connecting arm pivoting points	• Check operation.		√	√	√	√	
		• Lubricate with lithium-soap-based grease.			√		√	

PERIODIC MAINTENANCE AND MINOR REPAIR

NO.	ITEM	CHECK OR MAINTENANCE JOB	ODOMETER READING (×1,000 km)					Annual check
			1	10	20	30	40	
22	* Carburetors	<ul style="list-style-type: none"> • Check starter (choke) operation. • Adjust engine idling speed and synchronization. 	√	√	√	√	√	√
23	Engine oil	• Change.	√	√	√	√	√	√
		• Check oil level and vehicle for oil leakage.	√	√	√	√	√	√
24	Engine oil filter cartridge	• Replace.	√		√		√	
25	* Front and rear brake switches	• Check operation.	√	√	√	√	√	√
26	Moving parts and cables	• Lubricate.		√	√	√	√	√
27	* Lights, signals and switches	<ul style="list-style-type: none"> • Check operation. • Adjust headlight beam. 	√	√	√	√	√	√

EAU03884

NOTE:

- The air filter needs more frequent service if you are riding in unusually wet or dusty areas.
- Hydraulic brake service
 - Regularly check and, if necessary, correct the brake fluid level.
 - Every two years replace the internal components of the brake master cylinders and calipers, and change the brake fluid.
 - Replace the brake hoses every four years and if cracked or damaged.

PERIODIC MAINTENANCE AND MINOR REPAIR

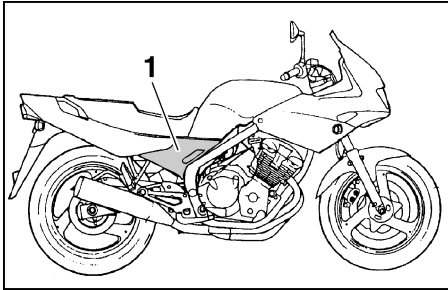

1. Panel A

EAU01777

Removing and installing the panel

The panel shown above needs to be removed to perform some of the maintenance jobs described in this chapter. Refer to this section each time the panel needs to be removed and installed.

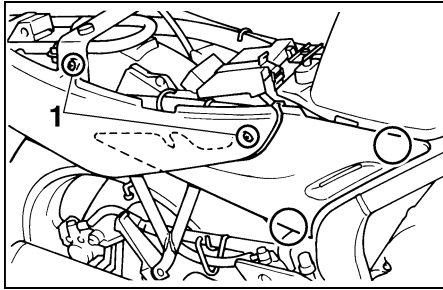

1. Screw (x 2)

EAU02926

Panel A

To remove the panel

1. Remove the seat. (See page 3-12 for seat removal and installation procedures.)
2. Remove the screws, and then slide the panel as shown to release it.

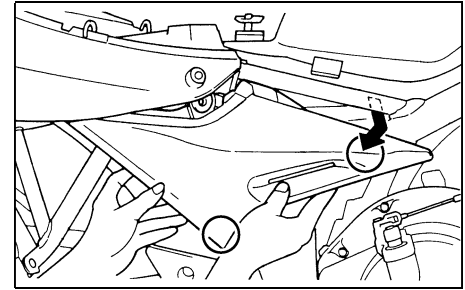

PERIODIC MAINTENANCE AND MINOR REPAIR

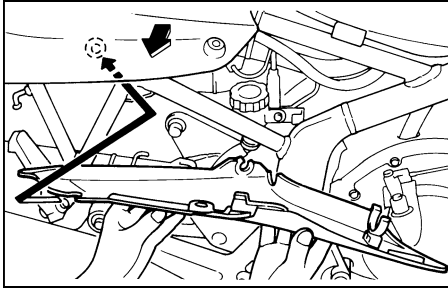

To install the panel

1. Place the panel in the original position, and then install the screws.
2. Install the seat.

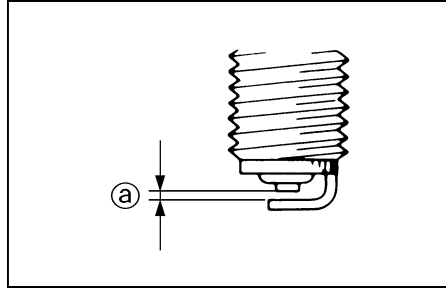

a. Spark plug gap

EAU01880

Checking the spark plugs

The spark plugs are important engine components, which should be checked periodically, preferably by a Yamaha dealer. Since heat and deposits will cause any spark plug to slowly erode, they should be removed and checked in accordance with the periodic maintenance and lubrication chart. In addition, the condition of the spark plugs can reveal the condition of the engine.

The porcelain insulator around the center electrode of each spark plug should be a medium-to-light tan (the ideal color when the motorcycle is ridden normally), and all spark plugs installed in the engine should have the same color. If any spark plug shows a distinctly different color, the engine could be defective. Do not attempt to diagnose such problems yourself. Instead, have a Yamaha dealer check the motorcycle. If a spark plug shows signs of electrode erosion and excessive carbon or other deposits, it should be replaced.

Specified spark plug:
CR8E (NGK) or
U24ESR-N (DENSO)

Before installing a spark plug, the spark plug gap should be measured with a wire thickness gauge and, if necessary, adjusted to specification.

Spark plug gap:
0.7–0.8 mm

PERIODIC MAINTENANCE AND MINOR REPAIR

Clean the surface of the spark plug gasket and its mating surface, and then wipe off any grime from the spark plug threads.

Tightening torque:
Spark plug:
12.5 Nm (1.25 m·kgf)

NOTE:
If a torque wrench is not available when installing a spark plug, a good estimate of the correct torque is 1/4–1/2 turn past finger tight. However, the spark plug should be tightened to the specified torque as soon as possible.

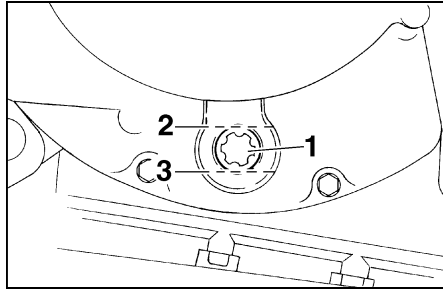

1. Engine oil level check window
2. Maximum level mark
3. Minimum level mark

EAU04185

Engine oil and oil filter cartridge

The engine oil level should be checked before each ride. In addition, the oil must be changed and the oil filter cartridge replaced at the intervals specified in the periodic maintenance and lubrication chart.

To check the engine oil level

1. Place the motorcycle on the centerstand.

NOTE:
Make sure that the motorcycle is positioned straight up when checking the oil level. A slight tilt to the side can result in a false reading.

2. Start the engine, warm it up for several minutes, and then turn it off.
3. Wait a few minutes until the oil settles, and then check the oil level through the check window located at the bottom-right side of the crankcase.

NOTE:
The engine oil should be between the minimum and maximum level marks.

4. If the engine oil is below the minimum level mark, add sufficient oil of the recommended type to raise it to the correct level.

PERIODIC MAINTENANCE AND MINOR REPAIR

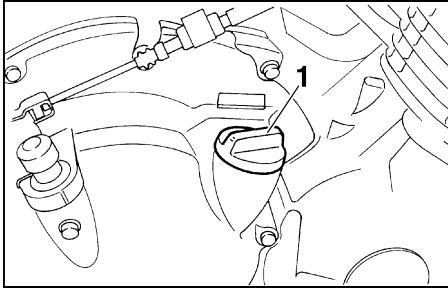

1. Engine oil filler cap

To change the engine oil (with or without oil filter cartridge replacement)

1. Start the engine, warm it up for several minutes, and then turn it off.
2. Place an oil pan under the engine to collect the used oil.

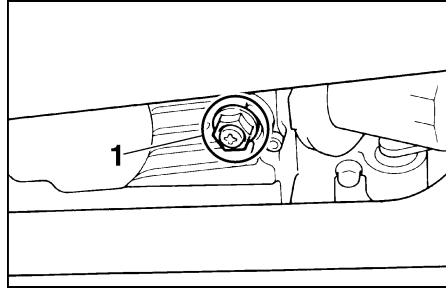

1. Engine oil drain bolt

3. Remove the engine oil filler cap and drain bolt to drain the oil from the crankcase.

NOTE: _____
Skip steps 4–6 if the oil filter cartridge is not being replaced.

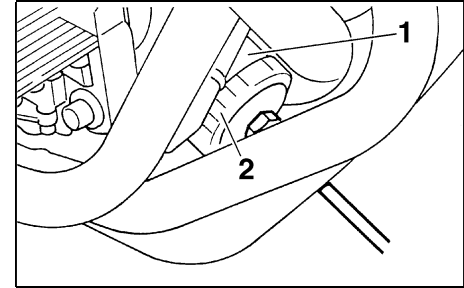

1. Oil filter cartridge

2. Oil filter wrench

4. Remove the oil filter cartridge with an oil filter wrench.

NOTE: _____
An oil filter wrench is available at a Yamaha dealer.

PERIODIC MAINTENANCE AND MINOR REPAIR

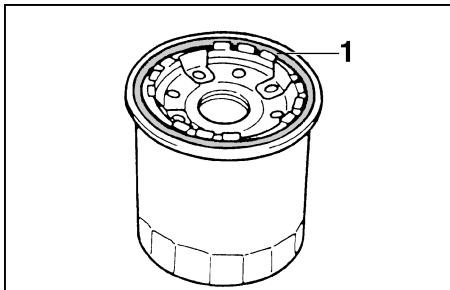

1. O-ring

5. Apply a thin coat of engine oil to the O-ring of the new oil filter cartridge.

NOTE: Make sure that the O-ring is properly seated.

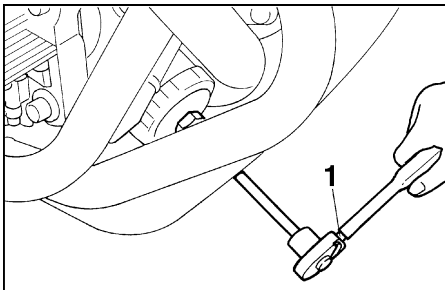

1. Torque wrench

6. Install the new oil filter cartridge with an oil filter wrench, and then tighten it to the specified torque with a torque wrench.

Tightening torque:
Oil filter cartridge:
17 Nm (1.7 m·kgf)

7. Install the engine oil drain bolt, and then tighten it to the specified torque.

Tightening torque:
Engine oil drain bolt:
43 Nm (4.3 m·kgf)

8. Add the specified amount of the recommended engine oil, and then install and tighten the oil filler cap.

Recommended engine oil:
See page 8-1.
Oil quantity:
Without oil filter cartridge replacement:
2.3 L
With oil filter cartridge replacement:
2.6 L
Total amount (dry engine):
3.1 L

PERIODIC MAINTENANCE AND MINOR REPAIR

EC000072

CAUTION:

- In order to prevent clutch slippage (since the engine oil also lubricates the clutch), do not mix any chemical additives with the oil or use oils of a higher grade than “CD”. In addition, do not use oils labeled “ENERGY CONSERVING II” or higher.
- Make sure that no foreign material enters the crankcase.

9. Start the engine, and then let it idle for several minutes while checking it for oil leakage. If oil is leaking, immediately turn the engine off and check for the cause.

NOTE:

After the engine is started, the engine oil level warning light should go off if the oil level is sufficient.

EC000067

CAUTION:

If the oil level warning light flickers or remains on, immediately turn the engine off and have a Yamaha dealer check the vehicle.

10. Turn the engine off, and then check the oil level and correct it if necessary.

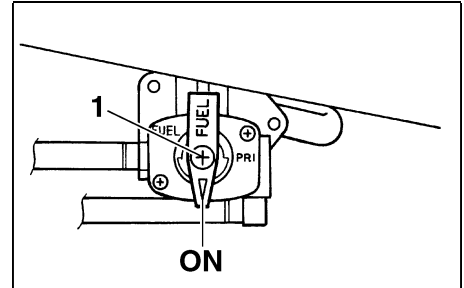

1. Screw

EAU02928*

Cleaning the air filter element

The air filter element should be cleaned at the intervals specified in the periodic maintenance and lubrication chart. Clean the air filter element more frequently if you are riding in unusually wet or dusty areas.

1. Remove the seat. (See page 3-12 for seat removal and installation procedures.)
2. Turn the fuel cock lever to “ON”, and then remove the fuel cock lever by removing the screw.

PERIODIC MAINTENANCE AND MINOR REPAIR

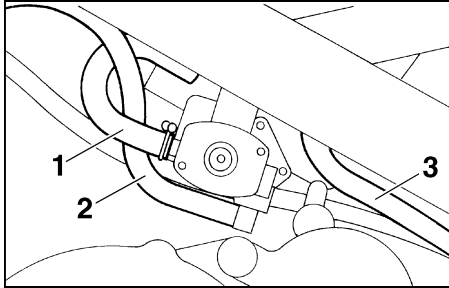

1. Fuel hose
2. Vacuum hose
3. Fuel tank drain hose

3. Disconnect the hoses shown.

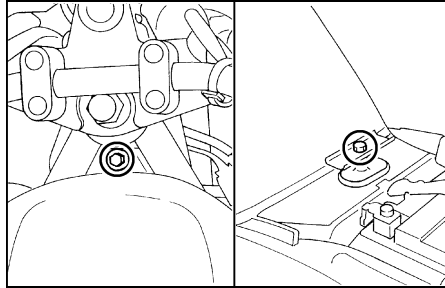

4. Remove the fuel tank by removing the bolts.

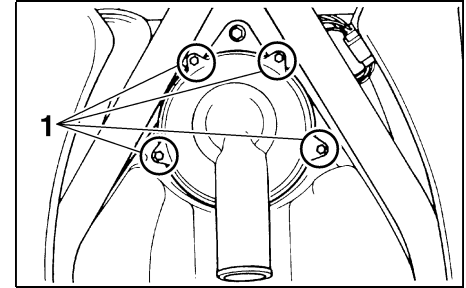

1. Screw (x 4)

5. Remove the air filter case cover by removing the screws.

6. Pull the air filter element out.

PERIODIC MAINTENANCE AND MINOR REPAIR

EC000082*

EAU00630

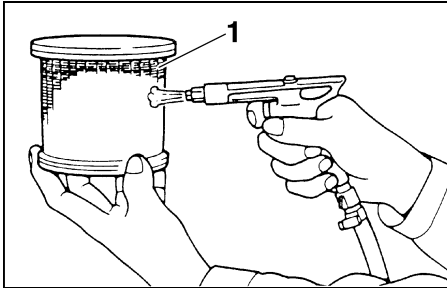

1. Air filter element

7. Lightly tap the air filter element to remove most of the dust and dirt, and then blow the remaining dirt out with compressed air as shown. If the air filter element is damaged, replace it.
8. Insert the air filter element into the air filter case.

CAUTION:

- Make sure that the air filter element is properly seated in the air filter case.
- The engine should never be operated without the air filter element installed, otherwise the pistons and/or cylinders may become excessively worn.

9. Install the air filter case cover by installing the screws.
10. Install the fuel tank by installing the bolts.
11. Connect the hoses.
12. Install the fuel cock lever by installing the screw.
13. Install the seat.

Adjusting the carburetors

The carburetors are important parts of the engine and require very sophisticated adjustment. Therefore, most carburetor adjustments should be left to a Yamaha dealer, who has the necessary professional knowledge and experience. The adjustment described in the following section, however, may be serviced by the owner as part of routine maintenance.

EC000095

CAUTION:

The carburetors have been set and extensively tested at the Yamaha factory. Changing these settings without sufficient technical knowledge may result in poor performance of or damage to the engine.

PERIODIC MAINTENANCE AND MINOR REPAIR

EAU00632

Adjusting the engine idling speed

The engine idling speed must be checked and, if necessary, adjusted as follows at the intervals specified in the periodic maintenance and lubrication chart.

1. Start the engine and warm it up for several minutes at 1,000–2,000 r/min while occasionally revving it to 4,000–5,000 r/min.

NOTE:

The engine is warm when it quickly responds to the throttle.

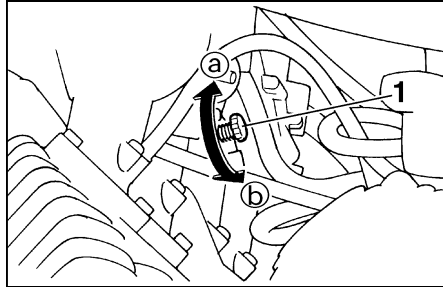

1. Throttle stop screw

2. Check the engine idling speed and, if necessary, adjust it to specification by turning the throttle stop screw. To increase the engine idling speed, turn the screw in direction **a**. To decrease the engine idling speed, turn the screw in direction **b**.

Engine idling speed:
1,200 – 1,300 r/min

NOTE:

If the specified idling speed cannot be obtained as described above, have a Yamaha dealer make the adjustment.

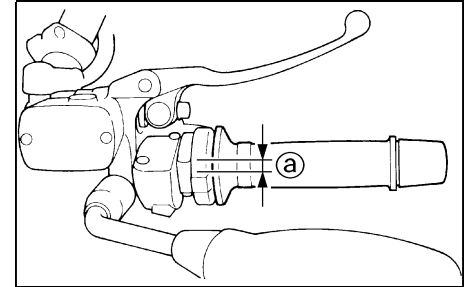

a. Throttle cable free play

EAU00635

Adjusting the throttle cable free play

The throttle cable free play should measure 3–5 mm at the throttle grip. Periodically check the throttle cable free play and, if necessary, have a Yamaha dealer adjust it.

PERIODIC MAINTENANCE AND MINOR REPAIR

Adjusting the valve clearance

EAU00637

The valve clearance changes with use, resulting in improper air-fuel mixture and/or engine noise. To prevent this from occurring, the valve clearance must be adjusted by a Yamaha dealer at the intervals specified in the periodic maintenance and lubrication chart.

Tires

To maximize the performance, durability, and safe operation of your motorcycle, note the following points regarding the specified tires.

Tire air pressure

The tire air pressure should be checked and, if necessary, adjusted before each ride.

EAU03362

Tire air pressure (measured on cold tires)		
Load*	Front	Rear
Up to 90 kg	200 kPa (2.00 kgf/cm ² , 2.00 bar)	225 kPa (2.25 kgf/cm ² , 2.25 bar)
90 kg–maximum	200 kPa (2.00 kgf/cm ² , 2.00 bar)	250 kPa (2.50 kgf/cm ² , 2.50 bar)
High-speed riding	200 kPa (2.00 kgf/cm ² , 2.00 bar)	250 kPa (2.50 kgf/cm ² , 2.50 bar)

EW000082

Maximum load*	XJ600S: 184 kg XJ600N: 187 kg
---------------	----------------------------------

* Total weight of rider, passenger, cargo and accessories

WARNING

- The tire air pressure must be checked and adjusted on cold tires (i.e., when the temperature of the tires equals the ambient temperature).
- The tire air pressure must be adjusted in accordance with the riding speed and with the total weight of rider, passenger, cargo, and accessories approved for this model.

PERIODIC MAINTENANCE AND MINOR REPAIR

EWA00012

⚠ WARNING

Because loading has an enormous impact on the handling, braking, performance and safety characteristics of your motorcycle, you should keep the following precautions in mind.

- **NEVER OVERLOAD THE MOTORCYCLE!** Operation of an overloaded motorcycle may result in tire damage, loss of control, or severe injury. Make sure that the total weight of rider, passenger, cargo, and accessories does not exceed the specified maximum load for the vehicle.
- Do not carry along loosely packed items, which can shift during a ride.
- Securely pack the heaviest items close to the center of the motorcycle and distribute the weight evenly on both sides.

- Adjust the suspension and tire air pressure with regard to the load.
- Check the tire condition and air pressure before each ride.

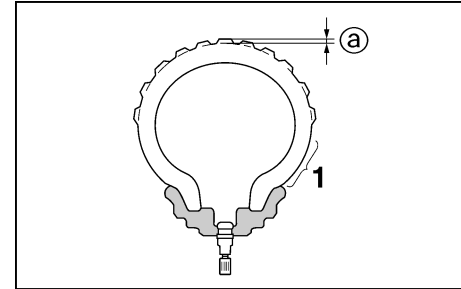

- 1. Tire sidewall
- a. Tire tread depth

Tire inspection

The tires must be checked before each ride. If the center tread depth reaches the specified limit, if the tire has a nail or glass fragments in it, or if the sidewall is cracked, have a Yamaha dealer replace the tire immediately.

Minimum tire tread depth (front and rear)	1.6 mm
--	--------

NOTE:

The tire tread depth limits may differ from country to country. Always comply with the local regulations.

PERIODIC MAINTENANCE AND MINOR REPAIR

EW000079

WARNING

- Have a Yamaha dealer replace excessively worn tires. Besides being illegal, operating the motorcycle with excessively worn tires decreases riding stability and can lead to loss of control.
- The replacement of all wheel- and brake-related parts, including the tires, should be left to a Yamaha dealer, who has the necessary professional knowledge and experience.

Tire information

This motorcycle is equipped with tube tires.

EW000078

WARNING

- The front and rear tires should be of the same make and design, otherwise the handling characteristics of the motorcycle cannot be guaranteed.
- After extensive tests, only the tires listed below have been approved for this model by Yamaha Motor Co., Ltd.

FRONT

Manufacturer	Size	Model
DUNLOP	110/80-17 57H	D103FA
DUNLOP	110/80-17 M/C 57H	D103FA
MICHELIN	110/80-17 57H	MACADAM 50
MICHELIN	110/80-17 M/C 57H	MACADAM 50

REAR

Manufacturer	Size	Model
DUNLOP	130/70-18 63H	D103A
DUNLOP	130/70-18 M/C 63H	D103A
MICHELIN	130/70-18 63H	MACADAM 50
MICHELIN	130/70-18 M/C 63H	MACADAM 50

EAU00683

WARNING

- Have a Yamaha dealer replace excessively worn tires. Besides being illegal, operating the motorcycle with excessively worn tires decreases riding stability and can lead to loss of control.
- The replacement of all wheel- and brake-related parts, including the tires, should be left to a Yamaha dealer, who has the necessary professional knowledge and experience.

PERIODIC MAINTENANCE AND MINOR REPAIR

EAU03773

Cast wheels

To maximize the performance, durability, and safe operation of your motorcycle, note the following points regarding the specified wheels.

- The wheel rims should be checked for cracks, bends or warpage before each ride. If any damage is found, have a Yamaha dealer replace the wheel. Do not attempt even the smallest repair to the wheel. A deformed or cracked wheel must be replaced.
- The wheel should be balanced whenever either the tire or wheel has been changed or replaced. An unbalanced wheel can result in poor performance, adverse handling characteristics, and a shortened tire life.
- Ride at moderate speeds after changing a tire since the tire surface must first be “broken in” for it to develop its optimal characteristics.

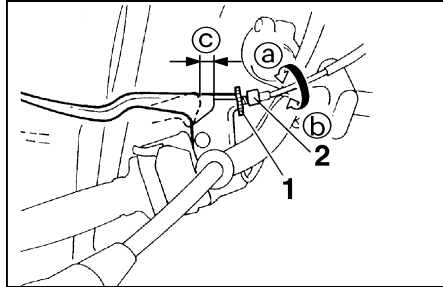

1. Locknut
2. Clutch lever free play adjusting bolt
- c. Clutch lever free play

EAU00694

Adjusting the clutch lever free play

The clutch lever free play should measure 2–3 mm as shown. Periodically check the clutch lever free play and, if necessary, adjust it as follows.

1. Loosen the locknut at the clutch lever.
2. To increase the clutch lever free play, turn the adjusting bolt in direction (a). To decrease the clutch lever free play, turn the adjusting bolt in direction (b).

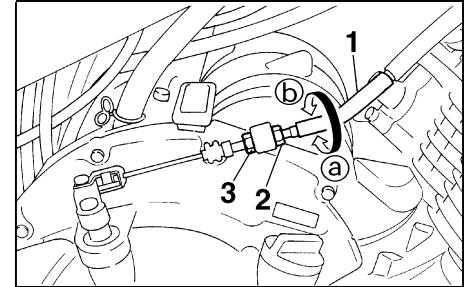

1. Clutch lever cable
2. Clutch lever free play adjusting nut
3. Locknut

3. If the specified clutch lever free play could be obtained as described above, tighten the locknut and skip the rest of the procedure, otherwise proceed as follows.
4. Fully turn the adjusting bolt at the clutch lever in direction (a) to loosen the clutch cable.
5. Loosen the locknut at the crankcase.
6. To increase the clutch lever free play, turn the adjusting nut in direction (a). To decrease the clutch lever free play, turn the adjusting nut in direction (b).

PERIODIC MAINTENANCE AND MINOR REPAIR

7. Tighten the locknut at the clutch lever and the crankcase.

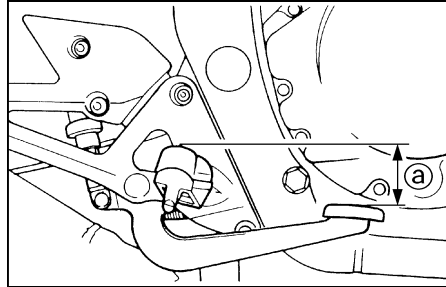

a. Distance between brake pedal and footrest

Adjusting the brake pedal position

EAU00712

The top of the brake pedal should be positioned approximately 40 mm below the top of the footrest as shown. Periodically check the brake pedal position and, if necessary, have a Yamaha dealer adjust it.

EW000109

! WARNING

A soft or spongy feeling in the brake pedal can indicate the presence of air in the hydraulic system. If there is air in the hydraulic system, have a Yamaha dealer bleed the system before operating the motorcycle. Air in the hydraulic system will diminish the braking performance, which may result in loss of control and an accident.

PERIODIC MAINTENANCE AND MINOR REPAIR

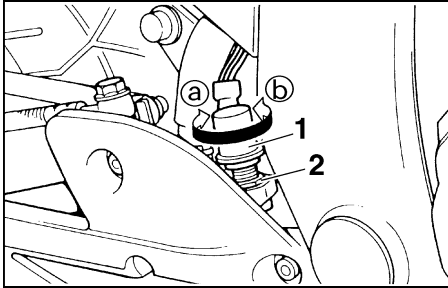

1. Rear brake light switch
2. Rear brake light switch adjusting nut

EAU00713

Adjusting the rear brake light switch

The rear brake light switch, which is activated by the brake pedal, is properly adjusted when the brake light comes on just before braking takes effect. If necessary, adjust the brake light switch as follows.

Turn the adjusting nut while holding the rear brake light switch in place. To make the brake light come on earlier, turn the adjusting nut in direction ①. To make the brake light come on later, turn the adjusting nut in direction ②.

EAU00721

Checking the front and rear brake pads

The front and rear brake pads must be checked for wear at the intervals specified in the periodic maintenance and lubrication chart.

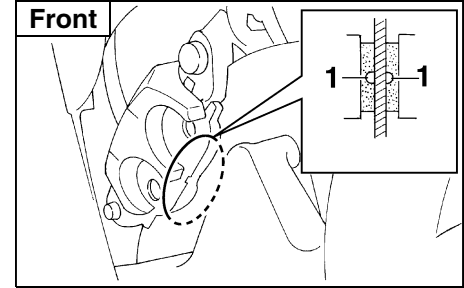

1. Brake pad wear indicator groove (× 2)

EAU00725

Front brake pads

Each front brake pad is provided with a wear indicator groove, which allows you to check the brake pad wear without having to disassemble the brake. To check the brake pad wear, check the wear indicator groove. If a brake pad has worn to the point that the wear indicator groove has almost disappeared, have a Yamaha dealer replace the brake pads as a set.

PERIODIC MAINTENANCE AND MINOR REPAIR

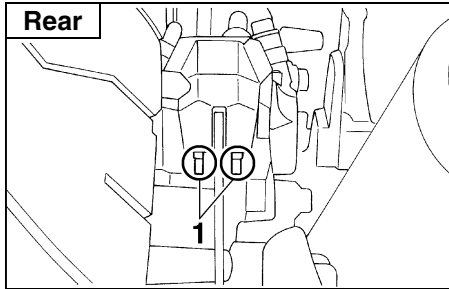

1. Brake pad wear indicator (× 2)

EAU00728

Rear brake pads

Each rear brake pad is provided with a wear indicator, which allows you to check the brake pad wear without having to disassemble the brake. To check the brake pad wear, check the position of the wear indicator while applying the brake. If a brake pad has worn to the point that the wear indicator almost touches the brake disc, have a Yamaha dealer replace the brake pads as a set.

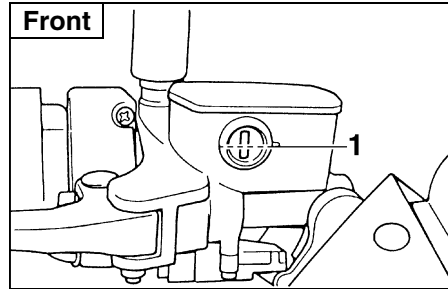

1. Minimum level mark

EAU03776

Checking the brake fluid level

Insufficient brake fluid may allow air to enter the brake system, possibly causing it to become ineffective. Before riding, check that the brake fluid is above the minimum level mark and replenish if necessary. A low brake fluid level may indicate worn brake pads and/or brake system leakage. If the brake level is low, be sure to check the brake pads for wear and the brake system for leakage.

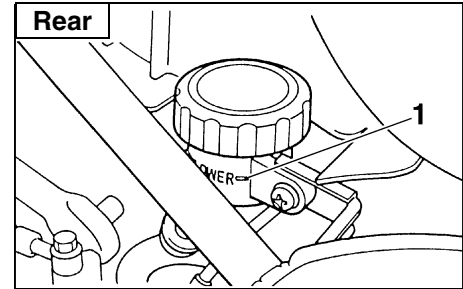

1. Minimum level mark

Observe these precautions:

- When checking the fluid level, make sure that the top of the brake fluid reservoir is level.
- Use only the recommended quality brake fluid, otherwise the rubber seals may deteriorate, causing leakage and poor braking performance.

Recommended brake fluid: DOT 4

- Refill with the same type of brake fluid. Mixing fluids may result in a harmful chemical reaction and lead to poor braking performance.

PERIODIC MAINTENANCE AND MINOR REPAIR

- Be careful that water does not enter the brake fluid reservoir when refilling. Water will significantly lower the boiling point of the fluid and may result in vapor lock.
- Brake fluid may deteriorate painted surfaces or plastic parts. Always clean up spilled fluid immediately.
- As the brake pads wear, it is normal for the brake fluid level to gradually go down. However, if the brake fluid level goes down suddenly, have a Yamaha dealer check the cause.

Changing the brake fluid

EAU03985*

Have a Yamaha dealer change the brake fluid at the intervals specified in the NOTE after the periodic maintenance and lubrication chart. In addition, have the oil seals of the brake master cylinders and calipers as well as the brake hose replaced at the intervals listed below or whenever they are damaged or leaking.

- Oil seals: Replace every two years.
- Brake hose: Replace every four years.

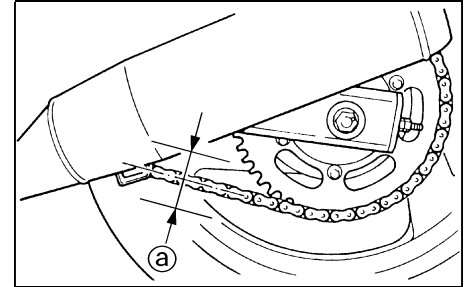

a. Drive chain slack

EAU00745

Drive chain slack

The drive chain slack should be checked before each ride and adjusted if necessary.

To check the drive chain slack

1. Place the motorcycle on the centerstand.
2. Shift the transmission into the neutral position.
3. Spin the rear wheel several times to locate the tightest portion of the drive chain.
4. Measure the drive chain slack as shown.

PERIODIC MAINTENANCE AND MINOR REPAIR

Drive chain slack:
30–40 mm

5. If the drive chain slack is incorrect, adjust it as follows.

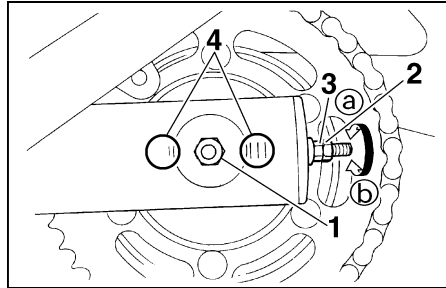

1. Axle nut
2. Locknut
3. Drive chain slack adjusting nut
4. Alignment marks

EAU03752

To adjust the drive chain slack

1. Loosen the axle nut, then loosen the locknut at each end of the swingarm.
2. To tighten the drive chain, turn the adjusting nut at each end of the swingarm in direction (a). To loosen the drive chain, turn the adjusting nut at each end of the swingarm in direction (b), and then push the rear wheel forward.

NOTE:

Using the alignment marks on each side of the swingarm, make sure that both adjusting nuts are in the same position for proper wheel alignment.

EC000096

CAUTION:

Improper drive chain slack will overload the engine as well as other vital parts of the motorcycle and can lead to chain slippage or breakage. To prevent this from occurring, keep the drive chain slack within the specified limits.

3. Tighten the locknuts, and then tighten the axle nut to the specified torque.

Tightening torque:

Axle nut:

105 Nm (10.5 m·kgf)

PERIODIC MAINTENANCE AND MINOR REPAIR

Lubricating the drive chain

EAU03006

The drive chain must be cleaned and lubricated at the intervals specified in the periodic maintenance and lubrication chart, otherwise it will quickly wear out, especially when riding in dusty or wet areas. Service the drive chain as follows.

EC000097

CAUTION:

The drive chain must be lubricated after washing the motorcycle or riding in the rain.

1. Clean the drive chain with kerosene and a small soft brush.

ECA00053

CAUTION:

To prevent damaging the O-rings, do not clean the drive chain with steam cleaners, high-pressure washers or inappropriate solvents.

2. Wipe the drive chain dry.
3. Thoroughly lubricate the drive chain with a special O-ring chain lubricant.

ECA00052

CAUTION:

Do not use engine oil or any other lubricants for the drive chain, as they may contain substances that could damage the O-rings.

EAU02962

Checking and lubricating the cables

The operation of all control cables and the condition of the cables should be checked before each ride, and the cables and cable ends should be lubricated if necessary. If a cable is damaged or does not move smoothly, have a Yamaha dealer check or replace it.

Recommended lubricant:
Engine oil

EW000112

WARNING

Damage to the outer sheath may interfere with proper cable operation and will cause the inner cable to rust. Replace a damaged cable as soon as possible to prevent unsafe conditions.

PERIODIC MAINTENANCE AND MINOR REPAIR

EAU04034

Checking and lubricating the throttle grip and cable

The operation of the throttle grip should be checked before each ride. In addition, the cable should be lubricated or replaced at the intervals specified in the periodic maintenance chart.

EAU03370

Checking and lubricating the brake and shift pedals

The operation of the brake and shift pedals should be checked before each ride, and the pedal pivots should be lubricated if necessary.

Recommended lubricant:
Lithium-soap-based grease
(all-purpose grease)

PERIODIC MAINTENANCE AND MINOR REPAIR

Checking and lubricating the brake and clutch levers

EAU03164

The operation of the brake and clutch levers should be checked before each ride, and the lever pivots should be lubricated if necessary.

Recommended lubricant:
Lithium-soap-based grease
(all-purpose grease)

Checking and lubricating the centerstand and sidestand

EAU03371

The operation of the centerstand and sidestand should be checked before each ride, and the pivots and metal-to-metal contact surfaces should be lubricated if necessary.



EW000114

If the centerstand or sidestand does not move up and down smoothly, have a Yamaha dealer check or repair it.

Recommended lubricant:
Lithium-soap-based grease
(all-purpose grease)

Lubricating the rear suspension

EAU00790

The pivoting points of the rear suspension must be lubricated at the intervals specified in the periodic maintenance and lubrication chart.

Recommended lubricant:
Molybdenum disulfide grease

PERIODIC MAINTENANCE AND MINOR REPAIR

Checking the front fork

EAU02939

The condition and operation of the front fork must be checked as follows at the intervals specified in the periodic maintenance and lubrication chart.

To check the condition

EW000115

⚠ WARNING

Securely support the motorcycle so that there is no danger of it falling over.

Check the inner tubes for scratches, damage and excessive oil leakage.

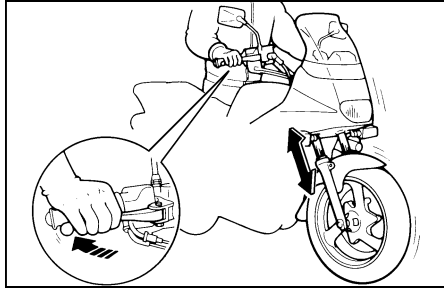

To check the operation

1. Place the motorcycle on a level surface and hold it in an upright position.
2. While applying the front brake, push down hard on the handlebars several times to check if the front fork compresses and rebounds smoothly.

EC000098

CAUTION:

If any damage is found or the front fork does not operate smoothly, have a Yamaha dealer check or repair it.

Checking the steering

EAU00794

Worn or loose steering bearings may cause danger. Therefore, the operation of the steering must be checked as follows at the intervals specified in the periodic maintenance and lubrication chart.

1. Place a stand under the engine to raise the front wheel off the ground.

EW000115

⚠ WARNING

Securely support the motorcycle so that there is no danger of it falling over.

PERIODIC MAINTENANCE AND MINOR REPAIR

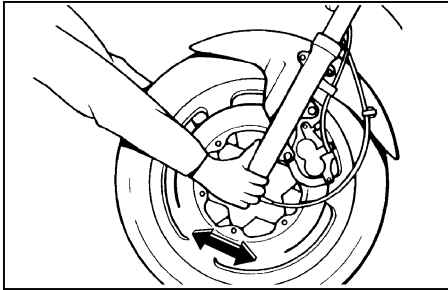

2. Hold the lower ends of the front fork legs and try to move them forward and backward. If any free play can be felt, have a Yamaha dealer check or repair the steering.

Checking the wheel bearings

EAU01144

The front and rear wheel bearings must be checked at the intervals specified in the periodic maintenance and lubrication chart. If there is play in the wheel hub or if the wheel does not turn smoothly, have a Yamaha dealer check the wheel bearings.

Battery

EAU00800

This motorcycle is equipped with a sealed-type (MF) battery, which does not require any maintenance. There is no need to check the electrolyte or to add distilled water.

EC000101

CAUTION:

Never attempt to remove the battery cell seals, as this would permanently damage the battery.

EW000116

⚠ WARNING

- **Electrolyte is poisonous and dangerous since it contains sulfuric acid, which causes severe burns. Avoid any contact with skin, eyes or clothing and always shield your eyes when working near batteries. In case of contact, administer the following FIRST AID.**

PERIODIC MAINTENANCE AND MINOR REPAIR

EC000102

- **EXTERNAL:** Flush with plenty of water.
- **INTERNAL:** Drink large quantities of water or milk and immediately call a physician.
- **EYES:** Flush with water for 15 minutes and seek prompt medical attention.
- Batteries produce explosive hydrogen gas. Therefore, keep sparks, flames, cigarettes, etc., away from the battery and provide sufficient ventilation when charging it in an enclosed space.
- **KEEP THIS AND ALL BATTERIES OUT OF THE REACH OF CHILDREN.**

To charge the battery

Have a Yamaha dealer charge the battery as soon as possible if it seems to have discharged. Keep in mind that the battery tends to discharge more quickly if the motorcycle is equipped with optional electrical accessories.

To store the battery

1. If the motorcycle will not be used for more than one month, remove the battery, fully charge it, and then place it in a cool, dry place.
2. If the battery will be stored for more than two months, check it at least once a month and fully charge it if necessary.
3. Fully charge the battery before installation.
4. After installation, make sure that the battery leads are properly connected to the battery terminals.

CAUTION:

- Always keep the battery charged. Storing a discharged battery can cause permanent battery damage.
- To charge a sealed-type (MF) battery, a special (constant-voltage) battery charger is required. Using a conventional battery charger will damage the battery. If you do not have access to a sealed-type (MF) battery charger, have a Yamaha dealer charge your battery.

PERIODIC MAINTENANCE AND MINOR REPAIR

EC000103

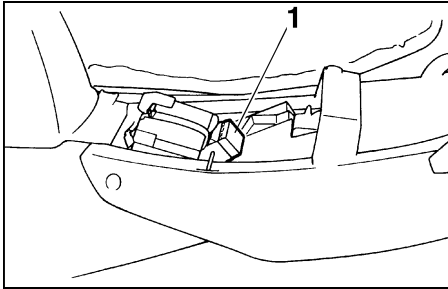

1. Fuse box

EAU01470

Replacing the fuses

The fuse box is located under the seat. (See page 3-12 for seat removal and installation procedures.)

If a fuse is blown, replace it as follows.

1. Turn the key to "OFF" and turn off the electrical circuit in question.
2. Remove the blown fuse, and then install a new fuse of the specified amperage.

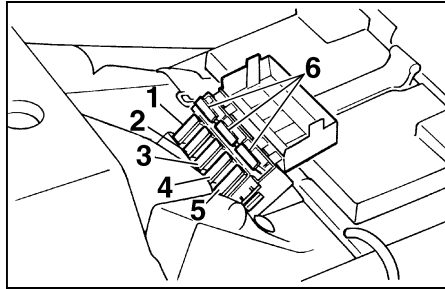

1. Main fuse
2. Ignition fuse
3. Signaling system fuse
4. Headlight fuse
5. Hazard fuse
6. Spare fuse (× 3)

Specified fuses:

Main fuse:	30 A
Ignition fuse:	10 A
Signaling system fuse:	15 A
Headlight fuse:	15 A
Hazard fuse:	10 A

CAUTION:

Do not use a fuse of a higher amperage rating than recommended to avoid causing extensive damage to the electrical system and possibly a fire.

3. Turn the key to "ON" and turn on the electrical circuit in question to check if the device operates.
4. If the fuse immediately blows again, have a Yamaha dealer check the electrical system.

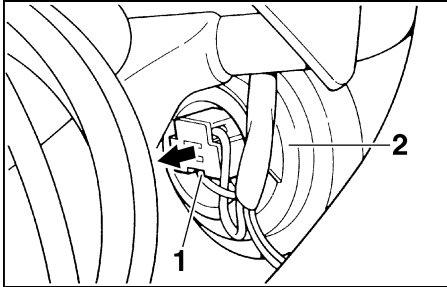

1. Headlight coupler
2. Headlight bulb cover

EAU04136

Replacing the headlight bulb (for XJ600S)

This motorcycle is equipped with a quartz bulb headlight. If the headlight bulb burns out, replace it as follows.

1. Disconnect the headlight coupler, and then remove the bulb cover.

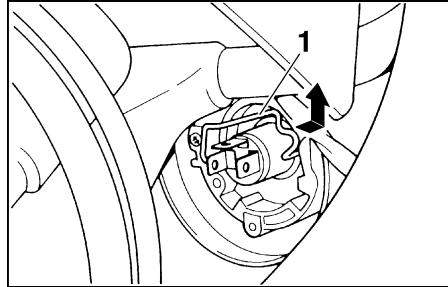

1. Headlight bulb holder
2. Unhook the headlight bulb holder, and then remove the defective bulb.

EW000119

! WARNING

Headlight bulbs get very hot. Therefore, keep flammable products away from a lit headlight bulb, and do not touch the bulb until it has cooled down.

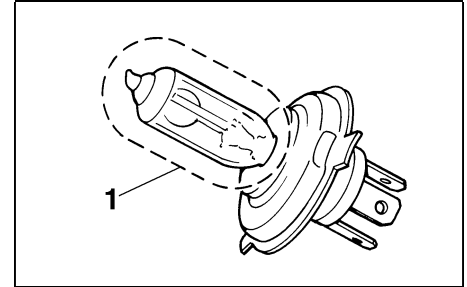

1. Do not touch this area.
3. Place a new headlight bulb into position, and then secure it with the bulb holder.

EC000105

CAUTION:

Do not touch the glass part of the headlight bulb to keep it free from oil, otherwise the transparency of the glass, the luminosity of the bulb, and the bulb life will be adversely affected. Thoroughly clean off any dirt and fingerprints on the headlight bulb using a cloth moistened with alcohol or thinner.

PERIODIC MAINTENANCE AND MINOR REPAIR

4. Install the headlight bulb cover, and then connect the coupler.
5. Have a Yamaha dealer adjust the headlight beam if necessary.

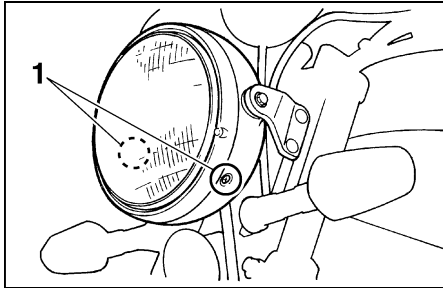

1. Screw (× 2)

EAU04189

Replacing the headlight bulb (for XJ600N)

This motorcycle is equipped with a quartz bulb headlight. If the headlight bulb burns out, replace it as follows.

1. Remove the headlight unit by removing the screws.

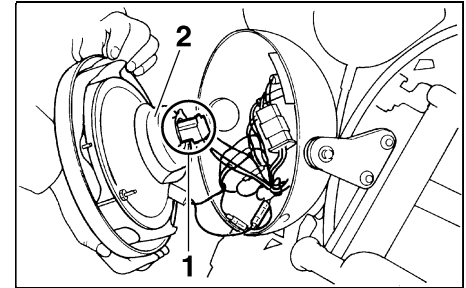

1. Headlight coupler
 2. Headlight bulb cover
2. Disconnect the headlight coupler, and then remove the bulb cover.

PERIODIC MAINTENANCE AND MINOR REPAIR

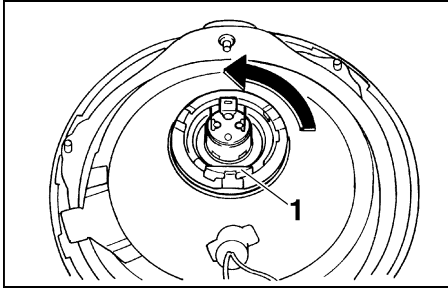

1. Headlight bulb holder

3. Unhook the headlight bulb holder, and then remove the defective bulb.

EW000119

⚠ WARNING

Headlight bulbs get very hot. Therefore, keep flammable products away from a lit headlight bulb, and do not touch the bulb until it has cooled down.

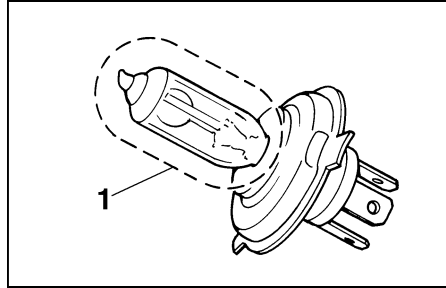

1. Do not touch this area.

4. Place a new headlight bulb into position, and then secure it with the bulb holder.

EC000105

CAUTION:

Do not touch the glass part of the headlight bulb to keep it free from oil, otherwise the transparency of the glass, the luminosity of the bulb, and the bulb life will be adversely affected. Thoroughly clean off any dirt and fingerprints on the headlight bulb using a cloth moistened with alcohol or thinner.

5. Install the headlight bulb cover, and then connect the coupler.
6. Install the headlight unit by installing the screws.
7. Have a Yamaha dealer adjust the headlight beam if necessary.

PERIODIC MAINTENANCE AND MINOR REPAIR

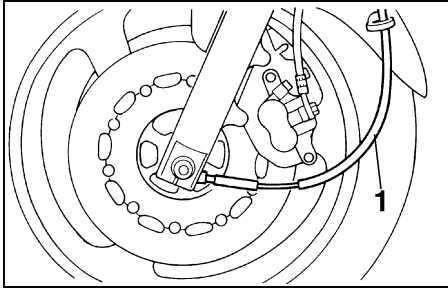

1. Speedometer cable

EAU00868

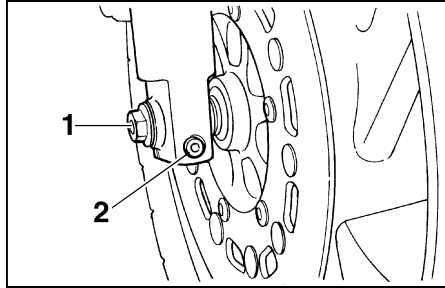

1. Front wheel axle
2. Front wheel axle pinch bolt

ECA00047

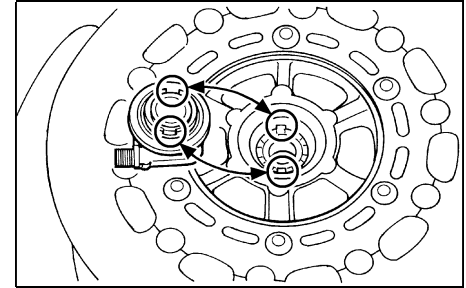

EAU04164

Front wheel

To remove the front wheel

EW000122

! WARNING

- It is advisable to have a Yamaha dealer service the wheel.
- Securely support the motorcycle so that there is no danger of it falling over.

1. Place the motorcycle on the centerstand.
2. Disconnect the speedometer cable from the front wheel.
3. Remove the brake calipers by removing the bolts.

CAUTION:

Do not pull the brake lever after the brake caliper has been removed, otherwise the brake pads will be forced shut.

4. Loosen the front wheel axle pinch bolt.
5. Pull the wheel axle out, and then remove the wheel.

To install the front wheel

1. Install the speedometer gear unit into the wheel hub so that the projections mesh with the slots.
2. Lift the wheel up between the fork legs.

NOTE:

Make sure that the slot in the speedometer gear unit fits over the retainer on the fork leg.

3. Insert the wheel axle.
4. Take the motorcycle off the centerstand so that the front wheel is on the ground.

PERIODIC MAINTENANCE AND MINOR REPAIR

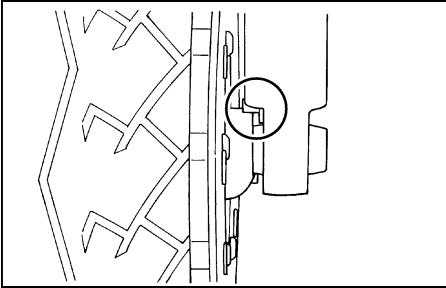

5. Install the brake calipers by installing the bolts.

NOTE:

Make sure that there is enough space between the brake pads before installing the brake calipers onto the brake discs.

6. Tighten the wheel axle, then the front wheel axle pinch bolt, and the brake caliper bolts to the specified torques.

Tightening torques:

Wheel axle:

58 Nm (5.8 m·kgf)

Front wheel axle pinch bolt:

40 Nm (4.0 m·kgf)

Brake caliper bolt:

19 Nm (1.9 m·kgf)

7. Connect the speedometer cable.
8. Push down hard on the handlebar several times to check for proper fork operation.

PERIODIC MAINTENANCE AND MINOR REPAIR

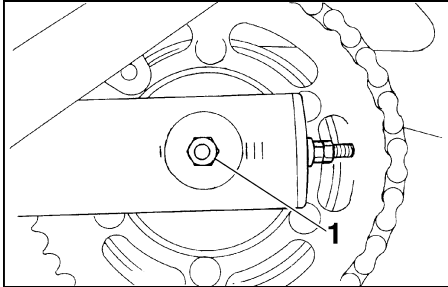

1. Rear wheel axle nut

EAU01480

Rear wheel

To remove the rear wheel

EW000122

! WARNING

- It is advisable to have a Yamaha dealer service the wheel.
- Securely support the motorcycle so that there is no danger of it falling over.

1. Place the motorcycle on the centerstand.
2. Remove the axle nut.

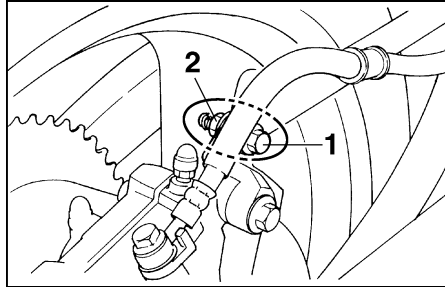

1. Brake torque rod bolt

2. Nut

3. Disconnect the brake torque rod from the brake caliper bracket by removing the nut and the bolt.

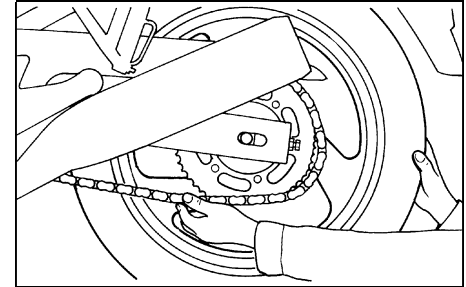

4. While supporting the brake caliper bracket, pull the wheel axle out.
5. Push the wheel forward, and then remove the drive chain from the rear sprocket.

NOTE:

The drive chain does not need to be disassembled in order to remove and install the rear wheel.

6. Remove the wheel.

ECA00048

CAUTION:

Do not apply the brake after the wheel has been removed together with the brake disc, otherwise the brake pads will be forced shut.

EAU01468

To install the rear wheel

1. Insert the wheel axle from the right-hand side.
2. Install the drive chain onto the rear sprocket, and then adjust the drive chain slack. (See page 6-21 for drive chain slack adjustment procedures.)
3. Install the axle nut and brake torque rod bolt at the brake caliper bracket.
4. Install the brake caliper by installing the bolts.

NOTE:

Make sure that there is enough space between the brake pads before installing the brake caliper onto the brake disc.

5. Take the motorcycle off the centerstand so that the rear wheel is on the ground.
6. Tighten the axle nut and brake torque rod bolt to the specified torques.

Tightening torques:

Axle nut:

105 Nm (10.5 m·kgf)

Brake torque rod bolt:

23 Nm (2.3 m·kgf)

EAU01008

Troubleshooting

Although Yamaha motorcycles receive a thorough inspection before shipment from the factory, trouble may occur during operation. Any problem in the fuel, compression, or ignition systems, for example, can cause poor starting and loss of power.

The following troubleshooting chart represents a quick and easy procedure for checking these vital systems yourself. However, should your motorcycle require any repair, take it to a Yamaha dealer, whose skilled technicians have the necessary tools, experience, and know-how to service the motorcycle properly.

Use only genuine Yamaha replacement parts. Imitation parts may look like Yamaha parts, but they are often inferior, have a shorter service life and can lead to expensive repair bills.

PERIODIC MAINTENANCE AND MINOR REPAIR

Troubleshooting chart

EAU01297

EW000125



WARNING

Keep away from open flames and do not smoke while checking or working on the fuel system.

1. Fuel

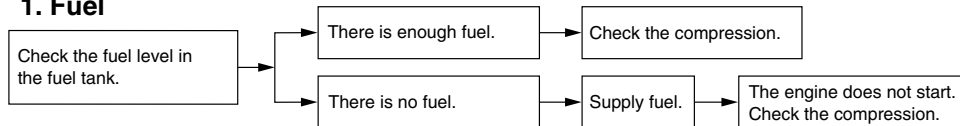

2. Compression

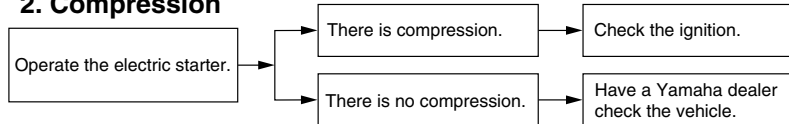

3. Ignition

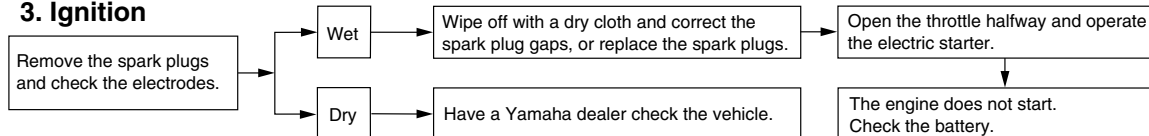

4. Battery

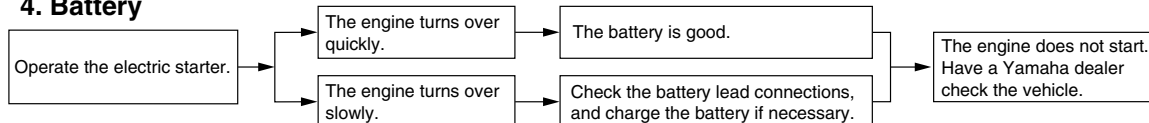

6

MOTORCYCLE CARE AND STORAGE

Care	7-1
Storage	7-4

Care

While the open design of a motorcycle reveals the attractiveness of the technology, it also makes it more vulnerable. Rust and corrosion can develop even if high-quality components are used. A rusty exhaust pipe may go unnoticed on a car, however, it detracts from the overall appearance of a motorcycle. Frequent and proper care does not only comply with the terms of the warranty, but it will also keep your motorcycle looking good, extend its life and optimize its performance.

Before cleaning

1. Cover the muffler outlets with plastic bags after the engine has cooled down.
2. Make sure that all caps and covers as well as all electrical couplers and connectors, including the spark plug caps, are tightly installed.
3. Remove extremely stubborn dirt, like oil burnt onto the crankcase, with a degreasing agent and a brush, but never apply such products onto seals, gaskets, sprockets, the drive chain and wheel axles. Always rinse the dirt and degreaser off with water.

Cleaning

ECA00010

CAUTION:

- **Avoid using strong acidic wheel cleaners, especially on spoked wheels. If such products are used on hard-to-remove dirt, do not leave the cleaner on the affected area any longer than instructed. Also, thoroughly rinse the area off with water, immediately dry it, and then apply a corrosion protection spray.**
- **Improper cleaning can damage windshields, cowlings, panels and other plastic parts. Use only a soft, clean cloth or sponge with mild detergent and water to clean plastic.**

MOTORCYCLE CARE AND STORAGE

- Do not use any harsh chemical products on plastic parts. Be sure to avoid using cloths or sponges which have been in contact with strong or abrasive cleaning products, solvent or thinner, fuel (gasoline), rust removers or inhibitors, brake fluid, antifreeze or electrolyte.
- Do not use high-pressure washers or steam-jet cleaners since they cause water seepage and deterioration in the following areas: seals (of wheel and swing-arm bearings, fork and brakes), electric components (couplers, connectors, instruments, switches and lights), breather hoses and vents.
- For motorcycles equipped with a windshield: Do not use strong cleaners or hard sponges as they will cause dulling or scratching. Some cleaning compounds for plastic may leave scratches on the windshield. Test the product on a small hidden part of the windshield to make sure that it does not leave any marks. If the windshield is scratched, use a quality plastic polishing compound after washing.

After normal use

Remove dirt with warm water, a mild detergent, and a soft, clean sponge, and then rinse thoroughly with clean water. Use a toothbrush or bottlebrush for hard-to-reach areas. Stubborn dirt and insects will come off more easily if the area is covered with a wet cloth for a few minutes before cleaning.

After riding in the rain, near the sea or on salt-sprayed roads

Since sea salt or salt sprayed on roads during winter are extremely corrosive in combination with water, carry out the following steps after each ride in the rain, near the sea or on salt-sprayed roads.

NOTE: _____
Salt sprayed on roads in the winter may remain well into spring.

1. Clean the motorcycle with cold water and a mild detergent, after the engine has cooled down.

ECA00012

CAUTION: _____
Do not use warm water since it increases the corrosive action of the salt.

2. After drying the motorcycle, apply a corrosion protection spray on all metal, including chrome- and nickel-plated, surfaces to prevent corrosion.

MOTORCYCLE CARE AND STORAGE

After cleaning

1. Dry the motorcycle with a chamois or an absorbing cloth.
2. Immediately dry the drive chain and lubricate it to prevent it from rusting.
3. Use a chrome polish to shine chrome, aluminum and stainless-steel parts, including the exhaust system. (Even the thermally induced discoloring of stainless-steel exhaust systems can be removed through polishing.)
4. To prevent corrosion, it is recommended to apply a corrosion protection spray on all metal, including chrome- and nickel-plated, surfaces.
5. Use spray oil as a universal cleaner to remove any remaining dirt.
6. Touch up minor paint damage caused by stones, etc.
7. Wax all painted surfaces.
8. Let the motorcycle dry completely before storing or covering it.

EWA00001

WARNING

- **Make sure that there is no oil or wax on the brakes or tires. If necessary, clean the brake discs and brake linings with a regular brake disc cleaner or acetone, and wash the tires with warm water and a mild detergent.**
 - **Before operating the motorcycle test its braking performance and cornering behavior.**
-

ECA00013

CAUTION:

- **Apply spray oil and wax sparingly and make sure to wipe off any excess.**
 - **Never apply oil or wax to any rubber and plastic parts, but treat them with a suitable care product.**
 - **Avoid using abrasive polishing compounds as they will wear away the paint.**
-

NOTE:

Consult a Yamaha dealer for advice on what products to use.

MOTORCYCLE CARE AND STORAGE

Storage

Short-term

Always store your motorcycle in a cool, dry place and, if necessary, protect it against dust with a porous cover.

ECA00014

CAUTION:

- **Storing the motorcycle in a poorly ventilated room or covering it with a tarp, while it is still wet, will allow water and humidity to seep in and cause rust.**
- **To prevent corrosion, avoid damp cellars, stables (because of the presence of ammonia) and areas where strong chemicals are stored.**

Long-term

Before storing your motorcycle for several months:

1. Follow all the instructions in the “Care” section of this chapter.
2. Turn the fuel cock lever to “ON”.
3. Drain the carburetor float chambers by loosening the drain bolts; this will prevent fuel deposits from building up. Pour the drained fuel into the fuel tank.
4. Fill up the fuel tank and add fuel stabilizer (if available) to prevent the fuel tank from rusting and the fuel from deteriorating.
5. Perform the following steps to protect the cylinders, piston rings, etc. from corrosion.
 - a. Remove the spark plug caps and spark plugs.
 - b. Pour a teaspoonful of engine oil into each spark plug bore.

- c. Install the spark plug caps onto the spark plugs, and then place the spark plugs on the cylinder head so that the electrodes are grounded. (This will limit sparking during the next step.)
- d. Turn the engine over several times with the starter. (This will coat the cylinder walls with oil.)
- e. Remove the spark plug caps from the spark plugs, and then install the spark plugs and the spark plug caps.

EWA00003

WARNING

To prevent damage or injury from sparking, make sure to ground the spark plug electrodes while turning the engine over.

6. Lubricate all control cables and the pivoting points of all levers and pedals as well as of the sidestand/centerstand.

MOTORCYCLE CARE AND STORAGE

7. Check and, if necessary, correct the tire air pressure, and then lift the motorcycle so that both of its wheels are off the ground. Alternatively, turn the wheels a little every month in order to prevent the tires from becoming degraded in one spot.
8. Cover the muffler outlets with plastic bags to prevent moisture from entering them.
9. Remove the battery and fully charge it. Store it in a cool, dry place and charge it once a month. Do not store the battery in an excessively cold or warm place (less than 0 °C or more than 30 °C). For more information on storing the battery, see page 6-27.

NOTE: _____
Make any necessary repairs before storing the motorcycle.

Specifications 8-1
Conversion table 8-5

Specifications

Model	XJ600S/XJ600N
Dimensions	
Overall length	2,170 mm
Overall width	735 mm
Overall height	
XJ600S	1,205 mm
XJ600N	1,090 mm
Seat height	770 mm
Wheelbase	1,445 mm
Ground clearance	150 mm
Minimum turning radius	2,700 mm
Basic weight (with oil and full fuel tank)	
XJ600S	213 kg
XJ600N	210 kg
Engine	
Engine type	Air-cooled 4-stroke, DOHC
Cylinder arrangement	Forward-inclined parallel 4-cylinder
Displacement	598 cm ³
Bore × Stroke	58.5 × 55.7 mm
Compression ratio	10:1
Starting system	Electric starter
Lubrication system	Wet sump

Engine oil

Type

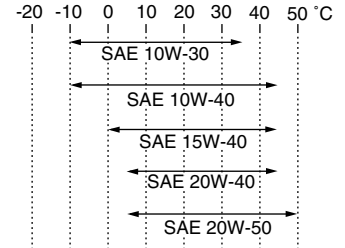

Recommended engine oil classification

API Service SE, SF, SG type or higher

CAUTION:

Be sure to use motor oils that do not contain anti-friction modifiers. Passenger car motor oils (often labeled "ENERGY CONSERVING II") contain anti-friction additives which will cause clutch and/or starter clutch slippage, resulting in reduced component life and poor engine performance.

Quantity

Without oil filter cartridge replacement	2.3 L
With oil filter cartridge replacement	2.6 L
Total amount (dry engine)	3.1 L

SPECIFICATIONS

Air filter	Dry type element
Fuel	
Type	REGULAR UNLEADED GASOLINE ONLY
Fuel tank capacity	17.0 L
Reserve amount	3.5 L
Carburetor	
Manufacturer	MIKUNI
Model × quantity	BDS28 × 4
Spark plug	
Model/Manufacturer	CR8E / NGK U24ESR-N / DENSO
Gap	0.7–0.8 mm
Clutch type	Wet, multiple-disc
Transmission	
Primary reduction system	Spur gear
Primary reduction ratio	2.225
Secondary reduction system	Chain drive
Secondary reduction ratio	3.000 (except for CH, A) 2.875 (for CH, A)
Number of drive chain sprocket teeth (rear/front)	48/16 (except for CH, A) 46/16 (for CH, A)
Transmission type	Constant mesh 6-speed

Operation	Left foot
Gear ratio	
1st	2.733
2nd	1.778
3rd	1.333
4th	1.074
5th	0.913
6th	0.821

Chassis

Frame type	Double cradle
Caster angle	25°
Trail	97 mm

Tire

Front	
Type	Tubeless tire
Size	110/80-17 57H 110/80-17 M/C 57H
Manufacturer/model	MICHELIN / MACADAM 50 DUNLOP / D103FA
Rear	
Type	Tubeless tire
Size	130/70-18 63H 130/70-18 M/C 63H
Manufacturer/model	MICHELIN / MACADAM 50 DUNLOP / D103A

SPECIFICATIONS

Maximum load*

XJ600S	184 kg
XJ600N	187 kg

Tire air pressure (measured on cold tires)

Up to 90 kg*

Front	200 kPa (2.00 kgf/cm ² , 2.00 bar)
Rear	225 kPa (2.25 kgf/cm ² , 2.25 bar)

90 kg—maximum*

Front	200 kPa (2.00 kgf/cm ² , 2.00 bar)
Rear	250 kPa (2.50 kgf/cm ² , 2.50 bar)

High-speed riding

Front	200 kPa (2.00 kgf/cm ² , 2.00 bar)
Rear	250 kPa (2.50 kgf/cm ² , 2.50 bar)

* Total weight of rider, passenger, cargo and accessories

Wheels

Front

Type	Cast wheel
Size	17 × MT 2.50

Rear

Type	Cast wheel
Size	18 × MT 3.50

Brakes

Front

Type	Dual disc brake
Operation	Right hand
Fluid	DOT 4

Rear

Type	Single disc brake
Operation	Right foot
Fluid	DOT 4

Suspension

Front

Telescopic fork

Rear

Swingarm (monocross suspension)

Spring/shock absorbers

Front

Coil spring / oil damper

Rear

Coil spring / gas-oil damper

Wheel travel

Front

140 mm

Rear

110 mm

Electrical systems

Ignition system

Transistorized coil ignition

Charging system

Type	A.C. magneto
Standard output	14 V, 20 A @ 5,000 r/min

Battery

Model	YTX9-BS
Voltage, capacity	12 V, 8 Ah

Headlight type Quartz bulb (halogen)

Bulb voltage, wattage × quantity

Headlight	12 V, 60/55 W × 1
Auxiliary light	12 V, 4 W × 1 (except for GB, IRL)
	12 V, 3.4 W × 1 (for GB, IRL)
Tail/brake light	12 V, 5/21 W × 1
Turn signal light	12 V, 21 W × 4
Meter lighting	
XJ600S	12 V, 1.7 W × 3
XJ600N	14 V, 3 W × 2
	12 V, 1.7 W × 2
Neutral indicator light	12 V, 3.4 W × 1
High beam indicator light	12 V, 3.4 W × 1
Oil level warning light	
XJ600S	12 V, 3.4 W × 1
XJ600N	14 V, 3 W × 1
Turn signal indicator light	12 V, 3.4 W × 2

Fuses

Main fuse	30 A
Ignition fuse	10 A
Signaling system fuse	15 A
Headlight fuse	15 A
Hazard fuse	10 A

SPECIFICATIONS

EAU03941

Conversion table

All specification data in this manual are listed in SI and METRIC UNITS.

Use this table to convert METRIC unit values to IMPERIAL unit values.

Example:

METRIC VALUE	CONVERSION FACTOR		IMPERIAL VALUE
2 mm	× 0.03937	=	0.08 in

Conversion table

METRIC SYSTEM TO IMPERIAL SYSTEM			
	Metric unit	Conversion factor	Imperial unit
Torque	m·kgf	× 7.233	ft·lb
	m·kgf	× 86.794	in·lb
	cm·kgf	× 0.0723	ft·lb
	cm·kgf	× 0.8679	in·lb
Weight	kg	× 2.205	lb
	g	× 0.03527	oz
Speed	km/h	× 0.6214	mi/h
Distance	km	× 0.6214	mi
	m	× 3.281	ft
	m	× 1.094	yd
	cm	× 0.3937	in
	mm	× 0.03937	in
Volume, Capacity	cc (cm ³)	× 0.03527	oz (IMP liq.)
	cc (cm ³)	× 0.06102	cu-in
	L (liter)	× 0.8799	qt (IMP liq.)
	L (liter)	× 0.2199	gal (IMP liq.)
Miscellaneous	kgf/mm	× 55.997	lb/in
	kgf/cm ²	× 14.2234	psi (lb/in ²)
	°C	× 1.8 + 32	°F

Identification numbers	9-1
Key identification number (for XJ600S)	9-1
Key identification number (for XJ600N)	9-1
Vehicle identification number	9-2
Model label	9-2

Identification numbers

EAU02944

Record the key identification number, vehicle identification number and model label information in the spaces provided below for assistance when ordering spare parts from a Yamaha dealer or for reference in case the vehicle is stolen.

1. KEY IDENTIFICATION NUMBER:

2. VEHICLE IDENTIFICATION NUMBER:

3. MODEL LABEL INFORMATION:

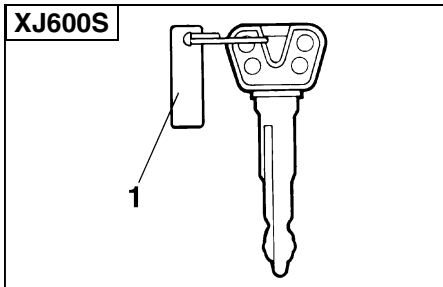

1. Key identification number

EAU01041

Key identification number (for XJ600S)

The key identification number is stamped into the key tag. Record this number in the space provided and use it for reference when ordering a new key.

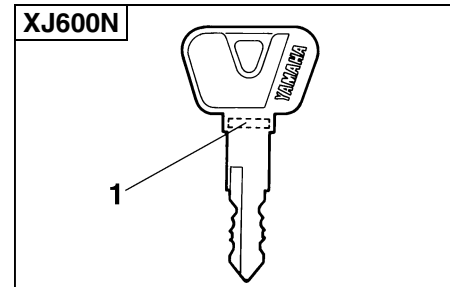

1. Key identification number

EAU01042

Key identification number (for XJ600N)

The key identification number is stamped into the key. Record this number in the space provided and use it for reference when ordering a new key.

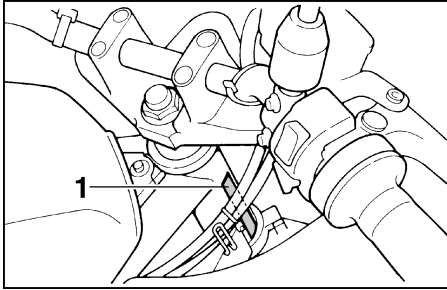

1. Vehicle identification number

EAU01043

Vehicle identification number

The vehicle identification number is stamped into the steering head pipe. Record this number in the space provided.

NOTE:

The vehicle identification number is used to identify your motorcycle and may be used to register your motorcycle with the licensing authority in your area.

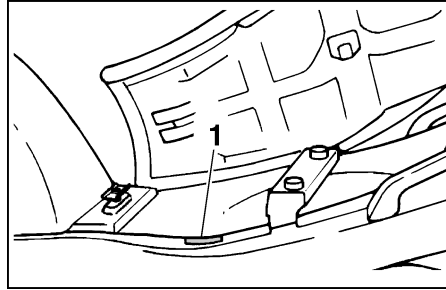

1. Model label

EAU01050

Model label

The model label is affixed to the frame under the seat. (See page 3-12 for seat removal and installation procedures.) Record the information on this label in the space provided. This information will be needed when ordering spare parts from a Yamaha dealer.

INDEX

A

Air filter element, cleaning6-10

B

Battery6-27

Brake and clutch levers, checking and lubricating6-25

Brake and shift pedals, checking and lubricating6-24

Brake fluid, changing6-21

Brake fluid level, checking6-20

Brake lever.....3-8

Brake light switch (rear), adjusting6-19

Brake pads, checking.....6-19

Brake pedal.....3-9

Brake pedal position, adjusting6-18

C

Cables, checking and lubricating6-23

Carburetors, adjusting.....6-12

Care.....7-1

Centerstand and sidestand, checking and lubricating6-25

Clutch lever.....3-7

Clutch lever free play, adjusting6-17

Conversion table.....8-5

D

Dimmer switch.....3-6

Drive chain, lubricating6-23

Drive chain slack6-21

 Checking.....6-21

 Adjusting.....6-22

E

Engine break-in5-4

Engine oil and oil filter cartridge6-7

Engine stop switch.....3-7

F

Front fork, checking6-26

Fuel3-10

Fuel cock.....3-11

Fuel consumption, tips for reducing5-4

Fuel tank breather hose (Germany only)3-11

Fuel tank cap.....3-9

Fuses, replacing6-29

H

Handlebar switches3-6

Hazard switch.....3-6

Headlight bulb, replacing (for XJ600S)...6-30

Headlight bulb, replacing (for XJ600N) ..6-31

Helmet holders3-13

High beam indicator light3-4

Horn switch3-6

I

Identification numbers9-1

Idling speed, adjusting6-13

Ignition circuit cut-off system3-16

Indicator and warning lights.....3-3

K

Key identification number (for XJ600N)9-1

Key identification number (for XJ600S)9-1

L

Light switch3-7

Luggage strap holders3-15

M

Main switch/steering lock3-1

Model label9-2

N

Neutral indicator light3-3

O

Oil level warning light3-4

P

Panel, removing and installing.....6-5

Parking.....5-5

Part locations2-1

Pass switch.....3-6

Periodic maintenance and lubrication chart6-2

Pre-operation check list.....4-1

S

Safety information.....	1-1
Seat.....	3-12
Shifting.....	5-3
Shift pedal.....	3-8
Shift points (for Switzerland only).....	5-3
Shock absorber assembly, adjusting.....	3-14
Sidestand.....	3-15
Spark plugs, checking.....	6-6
Specifications.....	8-1
Speedometer unit (for XJ600N).....	3-5
Speedometer unit (for XJ600S).....	3-4
Starter (choke) lever.....	3-12
Starting a cold engine.....	5-1
Starting a warm engine.....	5-2
Start switch.....	3-7
Steering, checking.....	6-26
Steering lock (for XJ600N).....	3-3
Storage.....	7-4
Storage compartment.....	3-14
Suspension (rear), lubricating.....	6-25

T

Tachometer.....	3-5
Throttle cable free play, adjusting.....	6-13
Throttle grip and cable, checking and lubricating.....	6-24
Tires.....	6-14
Tool kit.....	6-1
Troubleshooting.....	6-36
Troubleshooting chart.....	6-37
Turn signal indicator lights.....	3-3
Turn signal switch.....	3-6

V

Valve clearance, adjusting.....	6-14
Vehicle identification number.....	9-2

W

Wheel bearings, checking.....	6-27
Wheel (front).....	6-33
Installing.....	6-33
Removing.....	6-33
Wheel (rear).....	6-35
Installing.....	6-36
Removing.....	6-35
Wheels.....	6-17



PRINTED ON RECYCLED PAPER

PRINTED IN JAPAN
2001 · 6 - 0.3 × 1 CR
(E)