



OWNER'S MANUAL

YBR125

YBR125ED

3D9-F8199-EA

Welcome to the Yamaha world of motorcycling!

As the owner of the YBR125ED, you are benefiting from Yamaha's vast experience and newest technology regarding the design and manufacture of high-quality products, which have earned Yamaha a reputation for dependability.

Please take the time to read this manual thoroughly, so as to enjoy all advantages of your YBR125ED. The owner's manual does not only instruct you in how to operate, inspect and maintain your motorcycle, but also in how to safeguard yourself and others from trouble and injury.

In addition, the many tips given in this manual will help keep your motorcycle in the best possible condition. If you have any further questions, do not hesitate to contact your Yamaha dealer.

The Yamaha team wishes you many safe and pleasant rides. So, remember to put safety first!

IMPORTANT MANUAL INFORMATION

EAU10151

Particularly important information is distinguished in this manual by the following notations:

	The Safety Alert Symbol means ATTENTION! BECOME ALERT! YOUR SAFETY IS INVOLVED!
	Failure to follow WARNING instructions could result in severe injury or death to the motorcycle operator, a bystander, or a person inspecting or repairing the motorcycle.
CAUTION:	A CAUTION indicates special precautions that must be taken to avoid damage to the motorcycle.
NOTE:	A NOTE provides key information to make procedures easier or clearer.

NOTE:

- This manual should be considered a permanent part of this motorcycle and should remain with it even if the motorcycle is subsequently sold.
- Yamaha continually seeks advancements in product design and quality. Therefore, while this manual contains the most current product information available at the time of printing, there may be minor discrepancies between your motorcycle and this manual. If you have any questions concerning this manual, please consult your Yamaha dealer.

EWA10030

WARNING

PLEASE READ THIS MANUAL CAREFULLY AND COMPLETELY BEFORE OPERATING THIS MOTORCYCLE.

*Product and specifications are subject to change without notice.

IMPORTANT MANUAL INFORMATION

EAU37230

**YBR125ED
OWNER'S MANUAL
©2006 by Yamaha Motor Co., Ltd.
1st edition, December 2006
All rights reserved.
Any reprinting or unauthorized use
without the written permission of
Yamaha Motor Co., Ltd.
is expressly prohibited.
Printed in China.**

TABLE OF CONTENTS

SAFETY INFORMATION	1-1	PRE-OPERATION CHECKS	4-1	Adjusting the clutch lever	
DESCRIPTION	2-1	Pre-operation check list	4-2	free play	6-16
Left view	2-1	OPERATION AND		Checking the front brake lever	
Right view	2-2	IMPORTANT RIDING POINTS	5-1	free play	6-17
Controls and instruments.....	2-3	Starting a cold engine	5-1	Adjusting the brake pedal	
INSTRUMENT AND		Starting a warm engine	5-2	free play	6-18
CONTROL FUNCTIONS	3-1	Shifting	5-2	Adjusting the rear brake	
Main switch/steering lock	3-1	Tips for reducing fuel		light switch	6-18
Indicator lights	3-2	consumption	5-3	Checking the front brake pads	
Speedometer unit	3-2	Engine break-in	5-3	and rear brake shoes	6-19
Tachometer	3-3	Parking	5-4	Checking the front brake	
Fuel gauge	3-3	PERIODIC MAINTENANCE AND		fluid level	6-20
Handlebar switches	3-3	MINOR REPAIR	6-1	Changing the brake fluid	6-21
Clutch lever	3-4	Owner's tool kit	6-1	Drive chain slack	6-21
Shift pedal	3-4	Periodic maintenance and		Cleaning and lubricating	
Brake lever	3-5	lubrication chart	6-2	the drive chain	6-22
Brake pedal	3-5	Removing and installing panels	6-6	Checking and lubricating	
Fuel tank cap	3-5	Checking the spark plug	6-7	the cables	6-23
Fuel	3-6	Engine oil	6-9	Checking and lubricating	
Catalytic converter	3-7	Cleaning the air filter element	6-10	the throttle grip and cable	6-23
Fuel cock	3-7	Adjusting the carburetor	6-12	Checking and lubricating	
Starter (choke) lever	3-8	Adjusting the engine idling		the brake and shift pedals	6-24
Kickstarter	3-9	speed	6-12	Checking and lubricating	
Adjusting the shock absorber		Adjusting the throttle cable		the brake and clutch levers	6-24
assemblies	3-9	free play	6-13	Checking and lubricating the	
Carrier	3-10	Valve clearance	6-14	centerstand and sidestand	6-25
Luggage strap holders	3-10	Tires	6-14	Lubricating the swingarm	
Sidestand	3-10	Cast wheels	6-16	pivots	6-25
Ignition circuit cut-off system	3-11			Checking the front fork	6-26
				Checking the steering	6-26
				Checking the wheel bearings	6-27

TABLE OF CONTENTS

Battery	6-27
Replacing the fuse	6-29
Replacing the headlight bulb	6-30
Replacing the tail/ brake light bulb	6-32
Replacing a turn signal light bulb	6-32
Replacing the auxiliary light bulb	6-33
Front wheel	6-33
Rear wheel	6-35
Troubleshooting	6-37
Troubleshooting chart	6-38

MOTORCYCLE CARE AND

STORAGE	7-1
Matte color caution	7-1
Care	7-1
Storage	7-3

SPECIFICATIONS

8-1

CONSUMER INFORMATION.....

9-1

Identification numbers	9-1
------------------------------	-----

SAFETY INFORMATION

EAU10251

1

MOTORCYCLES ARE SINGLE TRACK VEHICLES. THEIR SAFE USE AND OPERATION ARE DEPENDENT UPON THE USE OF PROPER RIDING TECHNIQUES AS WELL AS THE EXPERTISE OF THE OPERATOR. EVERY OPERATOR SHOULD KNOW THE FOLLOWING REQUIREMENTS BEFORE RIDING THIS MOTORCYCLE.

HE OR SHE SHOULD:

- OBTAIN THOROUGH INSTRUCTIONS FROM A COMPETENT SOURCE ON ALL ASPECTS OF MOTORCYCLE OPERATION.
- OBSERVE THE WARNINGS AND MAINTENANCE REQUIREMENTS IN THE OWNER'S MANUAL.
- OBTAIN QUALIFIED TRAINING IN SAFE AND PROPER RIDING TECHNIQUES.
- OBTAIN PROFESSIONAL TECHNICAL SERVICE AS INDICATED BY THE OWNER'S MANUAL

AND/OR WHEN MADE NECESSARY BY MECHANICAL CONDITIONS.

Safe riding

- Always make pre-operation checks. Careful checks may help prevent an accident.
- This motorcycle is designed to carry the operator and a passenger.
- The failure of motorists to detect and recognize motorcycles in traffic is the predominating cause of automobile/motorcycle accidents. Many accidents have been caused by an automobile driver who did not see the motorcycle. Making yourself conspicuous appears to be very effective in reducing the chance of this type of accident.

Therefore:

- Wear a brightly colored jacket.
- Use extra caution when approaching and passing through intersections, since intersections are the most likely places for motorcycle accidents to occur.

- Ride where other motorists can see you. Avoid riding in another motorist's blind spot.
- Many motorcycle accidents involve inexperienced operators. In fact, many operators who have been involved in accidents do not even have a current motorcycle license.
- Make sure that you are qualified and that you only lend your motorcycle to other qualified operators.
- Know your skills and limits. Staying within your limits may help you to avoid an accident.
- We recommend that you practice riding your motorcycle where there is no traffic until you have become thoroughly familiar with the motorcycle and all of its controls.
- Many motorcycle accidents have been caused by error of the motorcycle operator. A typical error made by the operator is veering

wide on a turn due to EXCESSIVE SPEED or undercornering (insufficient lean angle for the speed).

- Always obey the speed limit and never travel faster than warranted by road and traffic conditions.
- Always signal before turning or changing lanes. Make sure that other motorists can see you.
- The posture of the operator and passenger is important for proper control.
 - The operator should keep both hands on the handlebar and both feet on the operator footrests during operation to maintain control of the motorcycle.
 - The passenger should always hold onto the operator, seat strap, or grab bar, if equipped, with both hands and keep both feet on the passenger footrests.
 - Never carry a passenger unless he or she can firmly place both feet on the passenger footrests.
- Never ride under the influence of alcohol or other drugs.

- This motorcycle is designed for on-road use only, therefore, it is not suitable for off-road use.

Protective apparel

The majority of fatalities from motorcycle accidents are the result of head injuries. The use of a safety helmet is the single most critical factor in the prevention or reduction of head injuries.

- Always wear an approved helmet.
- Wear a face shield or goggles. Wind in your unprotected eyes could contribute to an impairment of vision which could delay seeing a hazard.
- The use of a jacket, heavy boots, trousers, gloves, etc., is effective in preventing or reducing abrasions or lacerations.
- Never wear loose-fitting clothes, otherwise they could catch on the control levers, footrests, or wheels and cause injury or an accident.
- Never touch the engine or exhaust system during or after operation. They become very hot and can

cause burns. Always wear protective clothing that covers your legs, ankles, and feet.

- Passengers should also observe the precautions mentioned above.

Modifications

Modifications made to this motorcycle not approved by Yamaha, or the removal of original equipment, may render the motorcycle unsafe for use and may cause severe personal injury. Modifications may also make your motorcycle illegal to use.

Loading and accessories

Adding accessories or cargo to your motorcycle can adversely affect stability and handling if the weight distribution of the motorcycle is changed. To avoid the possibility of an accident, use extreme caution when adding cargo or accessories to your motorcycle. Use extra care when riding a motorcycle that has added cargo or accessories. Here are some general guidelines to follow if loading cargo or adding accessories to your motorcycle:

SAFETY INFORMATION

Loading

The total weight of the operator, passenger, accessories and cargo must not exceed the maximum load limit.

Maximum load:
198 kg (437 lb)

When loading within this weight limit, keep the following in mind:

- Cargo and accessory weight should be kept as low and close to the motorcycle as possible. Make sure to distribute the weight as evenly as possible on both sides of the motorcycle to minimize imbalance or instability.
- Shifting weights can create a sudden imbalance. Make sure that accessories and cargo are securely attached to the motorcycle before riding. Check accessory mounts and cargo restraints frequently.
- Never attach any large or heavy items to the handlebar, front fork, or front fender. These items, including such cargo as sleeping

bags, duffel bags, or tents, can create unstable handling or slow steering response.

Accessories

Genuine Yamaha accessories have been specifically designed for use on this motorcycle. Since Yamaha cannot test all other accessories that may be available, you must personally be responsible for the proper selection, installation and use of non-Yamaha accessories. Use extreme caution when selecting and installing any accessories.

Keep the following guidelines in mind, as well as those provided under “Loading” when mounting accessories.

- Never install accessories or carry cargo that would impair the performance of your motorcycle. Carefully inspect the accessory before using it to make sure that it does not in any way reduce ground clearance or cornering clearance,

limit suspension travel, steering travel or control operation, or obscure lights or reflectors.

- Accessories fitted to the handlebar or the front fork area can create instability due to improper weight distribution or aerodynamic changes. If accessories are added to the handlebar or front fork area, they must be as lightweight as possible and should be kept to a minimum.
- Bulky or large accessories may seriously affect the stability of the motorcycle due to aerodynamic effects. Wind may attempt to lift the motorcycle, or the motorcycle may become unstable in cross winds. These accessories may also cause instability when passing or being passed by large vehicles.
- Certain accessories can displace the operator from his or her normal riding position. This improper position limits the freedom of movement of the opera-

tor and may limit control ability, therefore, such accessories are not recommended.

- Use caution when adding electrical accessories. If electrical accessories exceed the capacity of the motorcycle's electrical system, an electric failure could result, which could cause a dangerous loss of lights or engine power.

Gasoline and exhaust gas

- **GASOLINE IS HIGHLY FLAMMABLE:**
 - Always turn the engine off when refueling.
 - Take care not to spill any gasoline on the engine or exhaust system when refueling.
 - Never refuel while smoking or in the vicinity of an open flame.
- Never start the engine or let it run for any length of time in a closed area. The exhaust fumes are poisonous and may cause loss of consciousness and death within a short time. Always operate your motorcycle in an area that has adequate ventilation.

- Always turn the engine off before leaving the motorcycle unattended and remove the key from the main switch. When parking the motorcycle, note the following:
 - The engine and exhaust system may be hot, therefore, park the motorcycle in a place where pedestrians or children are not likely to touch these hot areas.
 - Do not park the motorcycle on a slope or soft ground, otherwise it may fall over.
 - Do not park the motorcycle near a flammable source (e.g. a kerosene heater, or near an open flame), otherwise it could catch fire.
- When transporting the motorcycle in another vehicle, make sure that it is kept upright and that the fuel cock is turned to "ON" or "RES" (for vacuum type) / "OFF" (for manual type). If it should lean over, gasoline may leak out of the carburetor or fuel tank.
- If you should swallow any gasoline, inhale a lot of gasoline vapor, or allow gasoline to get into your

eyes, see your doctor immediately. If any gasoline spills on your skin or clothing, immediately wash the affected area with soap and water and change your clothes.

DESCRIPTION

EAU10410

Left view

2

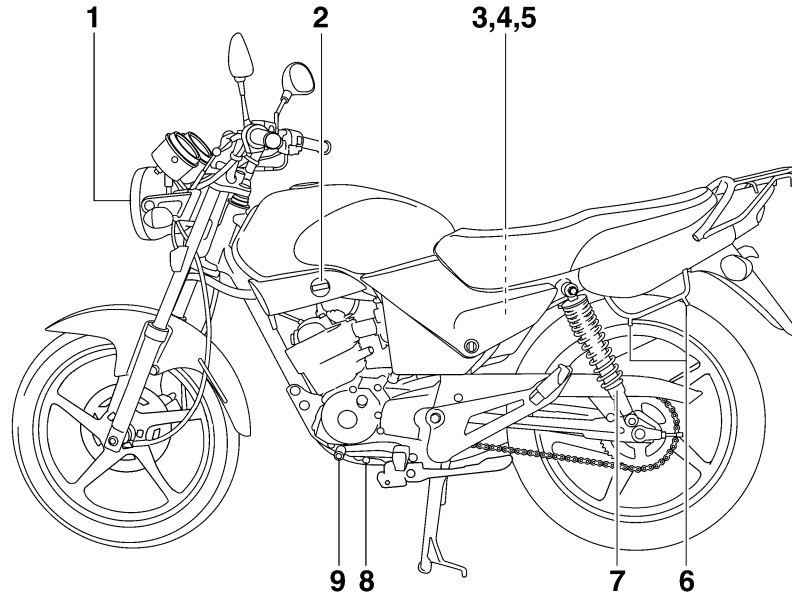

1. Headlight (page 6-30)

2. Fuel cock (page 3-7)

3. Fuse (page 6-29)

4. Battery (page 6-27)

5. Owner's tool kit (page 6-1)

6. Luggage strap holder (page 3-10)

7. Shock absorber assembly spring preload adjusting ring (page 3-9)

8. Engine oil drain bolt (page 6-9)

9. Shift pedal (page 3-4)

Right view

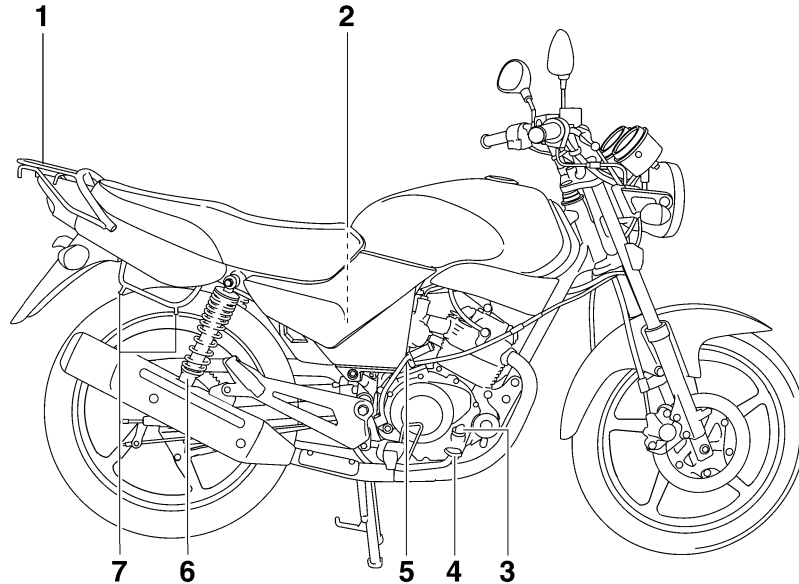

1. Carrier (page 3-10)
2. Air filter element (page 6-10)
3. Engine oil filler cap (page 6-9)
4. Brake pedal (page 3-5)
5. Kickstarter (page 3-9)
6. Shock absorber assembly spring preload adjusting ring (page 3-9)
7. Luggage strap holder (page 3-10)

DESCRIPTION

EAU10430

Controls and instruments

2

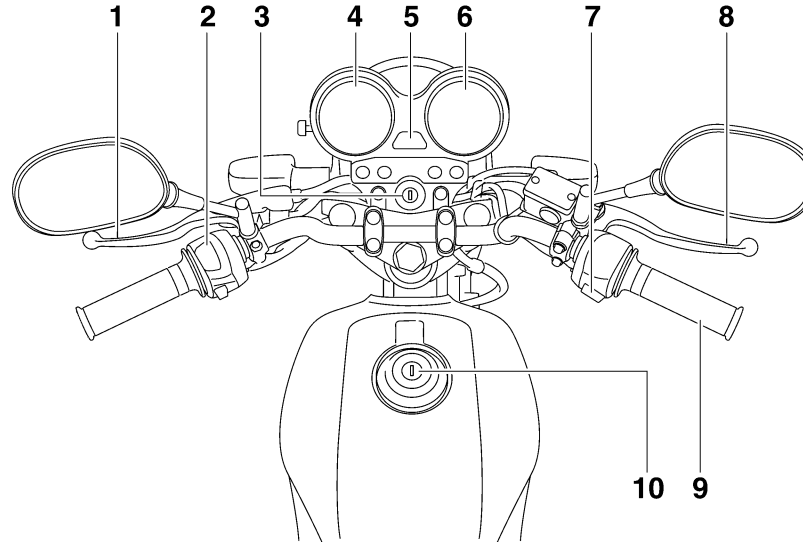

1. Clutch lever (page 3-4)
2. Left handlebar switches (page 3-3)
3. Main switch/steering lock (page 3-1)
4. Speedometer (page 3-2)
5. Fuel gauge (page 3-3)
6. Tachometer (page 3-3)
7. Right handlebar switch (page 3-3)
8. Brake lever (page 3-5)

9. Throttle grip (page 6-13)
10. Fuel tank cap (page 3-5)

INSTRUMENT AND CONTROL FUNCTIONS

Main switch/steering lock

EAU10460

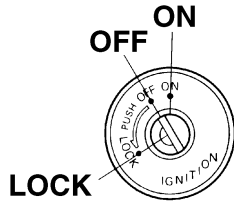

The main switch/steering lock controls the ignition and lighting systems, and is used to lock the steering. The various positions are described below.

ON

EAU33590

All electrical circuits are supplied with power; the meter lighting, taillight and auxiliary light come on, and the engine can be started. The key cannot be removed.

NOTE:

The headlight comes on automatically when the engine is started and stays on until the key is turned to "OFF", even if the engine stalls.

OFF

EAU10660

All electrical systems are off. The key can be removed.

LOCK

EAU43140

The steering is locked, and all electrical systems are off. The key can be removed.

To lock the steering

1

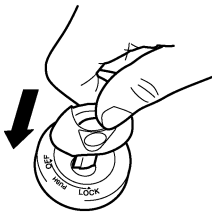

2



1. Push.
2. Turn.

1. Turn the handlebars all the way to the left.
2. Push the key in from the "OFF" position, and then turn it to "LOCK" while still pushing it.
3. Remove the key.

To unlock the steering

1

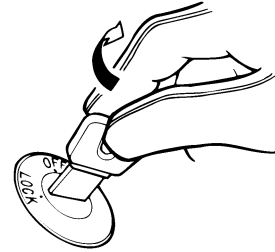

1. Turn.

Insert the key and turn it to "OFF".

EWA10060

! WARNING

Never turn the key to "OFF" or "LOCK" while the vehicle is moving, otherwise the electrical systems will be switched off, which may result in loss of control or an accident. Make sure that the vehicle is stopped before turning the key to "OFF" or "LOCK".

INSTRUMENT AND CONTROL FUNCTIONS

Indicator lights

EAU10980

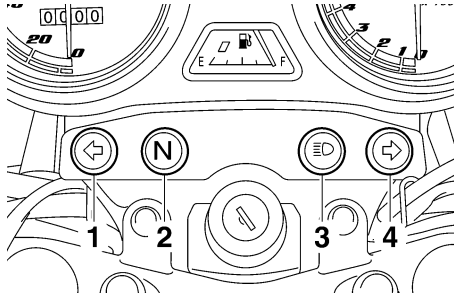

3

1. Left turn signal indicator light “

Turn signal indicator lights “ EAU11030

The corresponding indicator light flashes when the turn signal switch is pushed to the left or right.

Neutral indicator light “**N**”

EAU11060

This indicator light comes on when the transmission is in the neutral position.

High beam indicator light “ EAU11080

This indicator light comes on when the high beam of the headlight is switched on.

Speedometer unit

EAU11630

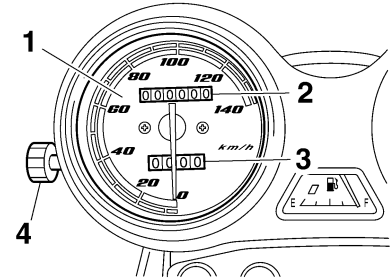

1. Speedometer
2. Odometer
3. Tripmeter
4. Tripmeter reset knob

The speedometer unit is equipped with a speedometer, an odometer and a tripmeter. The speedometer shows riding speed. The odometer shows the total distance traveled. The tripmeter shows the distance traveled since it was last set to zero with the reset knob. The tripmeter can be used to estimate the distance that can be traveled with a full tank of fuel. This information will enable you to plan future fuel stops.

INSTRUMENT AND CONTROL FUNCTIONS

Tachometer

EAU11851

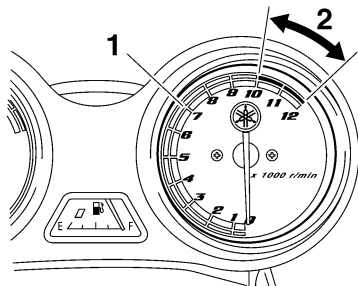

1. Tachometer
2. Tachometer red zone

The electric tachometer allows the rider to monitor the engine speed and keep it within the ideal power range.

ECA10031

CAUTION:

Do not operate the engine in the tachometer red zone.

Red zone: 10000 r/min and above

Fuel gauge

EAU37051

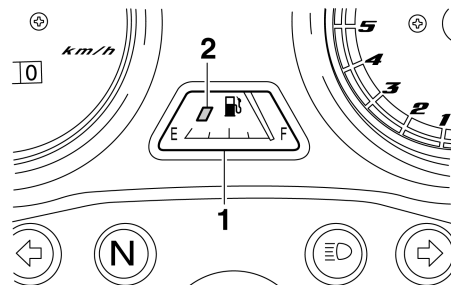

1. Fuel gauge
2. Red zone

The fuel gauge indicates the amount of fuel in the fuel tank. The needle moves towards “E” (Empty) as the fuel level decreases. When the needle reaches the red zone, approximately 1.7 L (0.45 US gal) (0.37 Imp.gal) remain in the fuel tank. If this occurs, refuel as soon as possible.

NOTE:

- Do not allow the fuel tank to empty itself completely.
- The main switch must be turned to “ON” for the fuel gauge to display an accurate fuel level reading.

Handlebar switches

EAU12347

Left

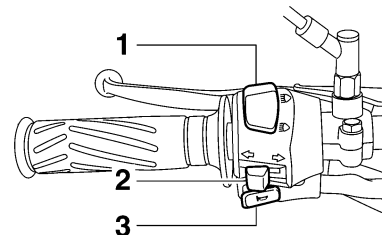

1. Dimmer switch “ $\text{☰}/\text{☱}$ ”
2. Turn signal switch “ $\text{↔}/\text{↔}$ ”
3. Horn switch “ 🔊 ”

Right

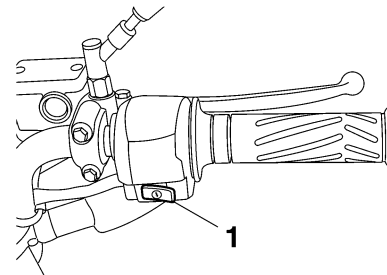



1. Start switch “ ⊕ ”

3

INSTRUMENT AND CONTROL FUNCTIONS



Dimmer switch “/”

EAU12400

Set this switch to “” for the high beam and to “” for the low beam.

Turn signal switch “/”

EAU12460

To signal a right-hand turn, push this switch to “”. To signal a left-hand turn, push this switch to “”. When released, the switch returns to the center position. To cancel the turn signal lights, push the switch in after it has returned to the center position.

Horn switch “”

EAU12500

Press this switch to sound the horn.

Start switch “”

EAU12710

Push this switch to crank the engine with the starter.

ECA10050

CAUTION:

See page 5-1 for starting instructions prior to starting the engine.

Clutch lever

EAU12820

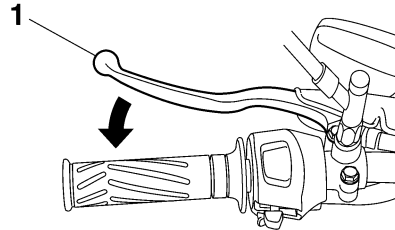

1. Clutch lever

The clutch lever is located at the left handlebar grip. To disengage the clutch, pull the lever toward the handlebar grip. To engage the clutch, release the lever. The lever should be pulled rapidly and released slowly for smooth clutch operation.

The clutch lever is equipped with a clutch switch, which is part of the ignition circuit cut-off system. (See page 3-11.)

Shift pedal

EAU12870

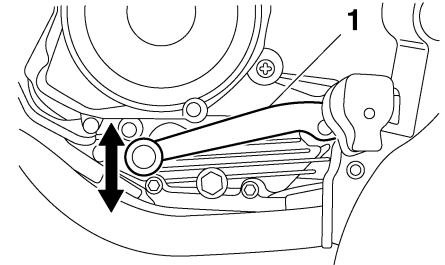

1. Shift pedal

The shift pedal is located on the left side of the engine and is used in combination with the clutch lever when shifting the gears of the 5-speed constant-mesh transmission equipped on this motorcycle.

INSTRUMENT AND CONTROL FUNCTIONS

Brake lever

EAU12890

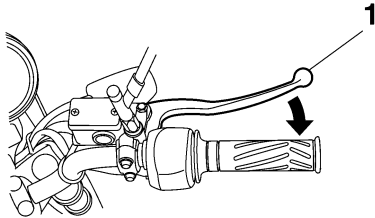

1. Brake lever

The brake lever is located at the right handlebar grip. To apply the front brake, pull the lever toward the handlebar grip.

Brake pedal

EAU12941

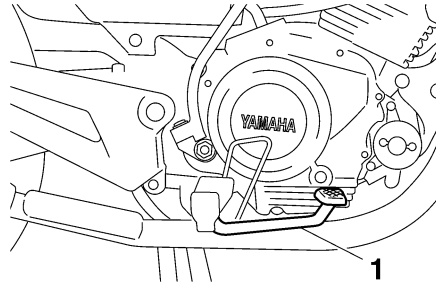

1. Brake pedal

The brake pedal is on the right side of the motorcycle. To apply the rear brake, press down on the brake pedal.

Fuel tank cap

EAU13001

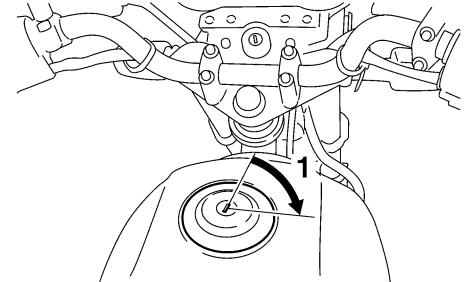

1. Unlock.

To remove the fuel tank cap

Insert the key into the lock and turn it 1/4 turn clockwise. The lock will be released and the fuel tank cap can be removed.

To install the fuel tank cap

1. Push the fuel tank cap into position with the key inserted in the lock.
2. Turn the key counterclockwise to the original position, and then remove it.

INSTRUMENT AND CONTROL FUNCTIONS

NOTE: _____

The fuel tank cap cannot be installed unless the key is in the lock. In addition, the key cannot be removed if the cap is not properly installed and locked.

EWA11140

WARNING _____

Make sure that the fuel tank cap is properly installed before riding.

Fuel

EAU13220

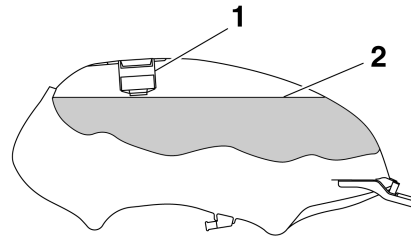

1. Fuel tank filler tube
2. Fuel level

Make sure that there is sufficient fuel in the tank. When refueling, be sure to insert the pump nozzle into the fuel tank filler hole and to fill the tank to the bottom of the filler tube as shown.

EWA10880

WARNING _____

- Do not overfill the fuel tank, otherwise it may overflow when the fuel warms up and expands.
- Avoid spilling fuel on the hot engine.

ECA10070

CAUTION: _____

Immediately wipe off spilled fuel with a clean, dry, soft cloth, since fuel may deteriorate painted surfaces or plastic parts.

EAU13320

Recommended fuel:

REGULAR UNLEADED GASOLINE ONLY

Fuel tank capacity:

12.0 L (3.17 US gal) (2.64 Imp.gal)

Fuel reserve amount:

1.7 L (0.45 US gal) (0.37 Imp.gal)

ECA11400

CAUTION: _____

Use only unleaded gasoline. The use of leaded gasoline will cause severe damage to internal engine parts, such as the valves and piston rings, as well as to the exhaust system.

Your Yamaha engine has been designed to use regular unleaded gasoline with a research octane number of 91 or higher. If knocking (or pinging) occurs, use a gasoline of a different brand

or premium unleaded fuel. Use of unleaded fuel will extend spark plug life and reduce maintenance costs.

Catalytic converter

This model is equipped with a catalytic converter in the exhaust system.

WARNING

The exhaust system is hot after operation. Make sure that the exhaust system has cooled down before doing any maintenance work.

CAUTION:

The following precautions must be observed to prevent a fire hazard or other damages.

- Use only unleaded gasoline. The use of leaded gasoline will cause unreparable damage to the catalytic converter.
- Never park the vehicle near possible fire hazards such as grass or other materials that easily burn.
- Do not allow the engine to idle too long.

EAU13431

EWA10860

ECA10700

Fuel cock

The fuel cock supplies fuel from the tank to the carburetor while filtering it also.

NOTE:

Depending on the model, the positions indicated on the fuel cock differ as shown in the following illustrations.

The fuel cock has three positions:

“OFF” or “●”

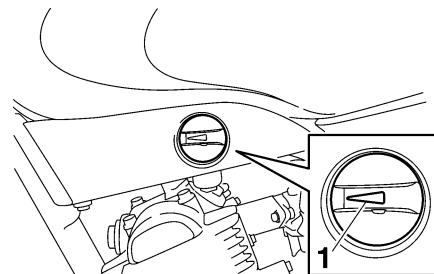



1. Arrow mark pointing to “OFF” or “●”

With the lever in this position, fuel will not flow. Always return the lever to this position when the engine is not running.

INSTRUMENT AND CONTROL FUNCTIONS

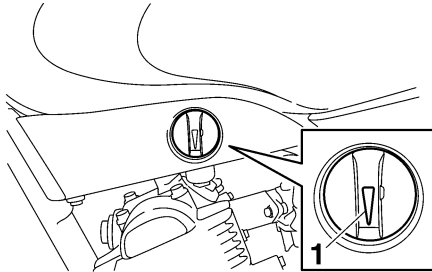
“ON” or “”



1. Arrow mark pointing to “ON” or “”

With the lever in this position, fuel flows to the carburetor. Normal riding is done with the lever in this position.

“RES” or “”

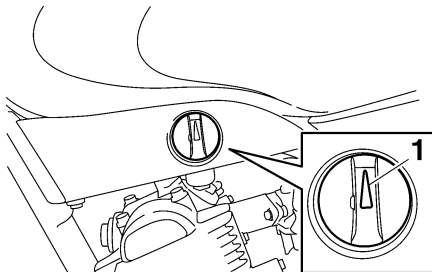



1. Arrow mark pointing to “RES” or “”

This indicates reserve. If you run out of fuel while riding, move the lever to this position. Fill the tank at the first opportunity. Be sure to set the lever back to “ON” or “” after refueling!

Starter (choke) lever “”

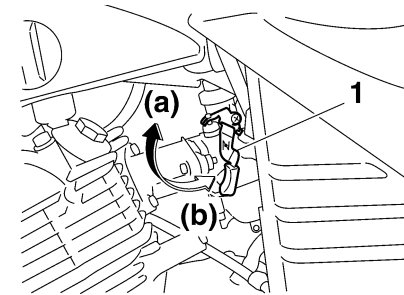
EAU13590



1. Starter (choke) lever “”

Starting a cold engine requires a richer air-fuel mixture, which is supplied by the starter (choke).

Move the lever in direction (a) to turn on the starter (choke).

Move the lever in direction (b) to turn off the starter (choke).

Kickstarter

EAU43150

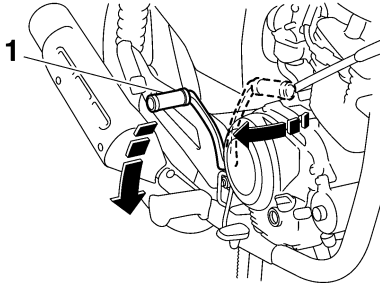

1. Kickstarter

If the engine fails to start by pushing the start switch, try to start it by using the kickstarter. To start the engine, fold out the kickstarter lever, move it down lightly with your foot until the gears engage, and then push it down smoothly but forcefully. This model is equipped with a primary kickstarter, allowing the engine to be started in any gear if the clutch is disengaged and the sidestand is up. However, shifting the transmission into the neutral position before starting is recommended.

Adjusting the shock absorber assemblies

EAU14880

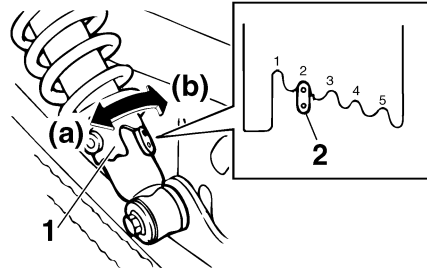

1. Spring preload adjusting ring
2. Position indicator

Each shock absorber assembly is equipped with a spring preload adjusting ring.

CAUTION:

Never attempt to turn an adjusting mechanism beyond the maximum or minimum settings.

ECA10100

⚠ WARNING

Always adjust both shock absorber assemblies equally, otherwise poor handling and loss of stability may result.

Adjust the spring preload as follows. To increase the spring preload and thereby harden the suspension, turn the adjusting ring on each shock absorber assembly in direction (a). To decrease the spring preload and thereby soften the suspension, turn the adjusting ring on each shock absorber assembly in direction (b).

NOTE:

Align the appropriate notch in the adjusting ring with the position indicator on the shock absorber.

Spring preload setting:

Minimum (soft):

1

Standard:

2

Maximum (hard):

5

INSTRUMENT AND CONTROL FUNCTIONS

Carrier

EAU15110

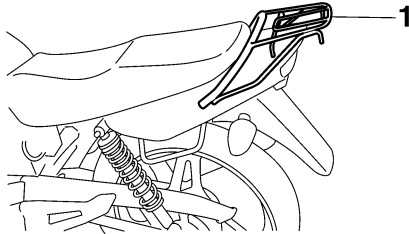

1. Carrier

3

WARNING

EWA10170

- Do not exceed the load limit of 3 kg (6.6 lb) for the carrier.
- Do not exceed the maximum load of 198 kg (437 lb) for the vehicle.

Luggage strap holders

EAU15190

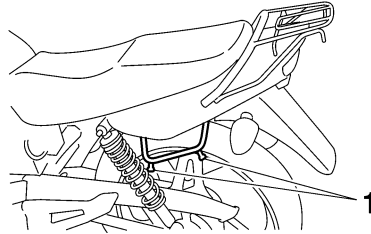

1. Luggage strap holder

There are four luggage strap holders below the rear of the seat.

Sidestand

EAU15301

The sidestand is located on the left side of the frame. Raise the sidestand or lower it with your foot while holding the vehicle upright.

NOTE:

The built-in sidestand switch is part of the ignition circuit cut-off system, which cuts the ignition in certain situations. (See further down for an explanation of the ignition circuit cut-off system.)

WARNING

EWA10240

The vehicle must not be ridden with the sidestand down, or if the sidestand cannot be properly moved up (or does not stay up), otherwise the sidestand could contact the ground and distract the operator, resulting in a possible loss of control. Yamaha's ignition circuit cut-off system has been designed to assist the operator in fulfilling the responsibility of raising the sidestand before starting off. Therefore, check this system regularly as described

below and have a Yamaha dealer repair it if it does not function properly.

EAU43160

Ignition circuit cut-off system

The ignition circuit cut-off system (comprising the sidestand switch, clutch switch and neutral switch) has the following functions.

- It prevents starting when the transmission is in gear and the sidestand is up, but the clutch lever is not pulled.
- It prevents starting when the transmission is in gear and the clutch lever is pulled, but the sidestand is still down.
- It cuts the running engine when the transmission is in gear and the sidestand is moved down.

Periodically check the operation of the ignition circuit cut-off system according to the following procedure.

EWA10260

WARNING

- **The vehicle must be placed on the centerstand during this inspection.**
 - **If a malfunction is noted, have a Yamaha dealer check the system before riding.**
-

INSTRUMENT AND CONTROL FUNCTIONS

3

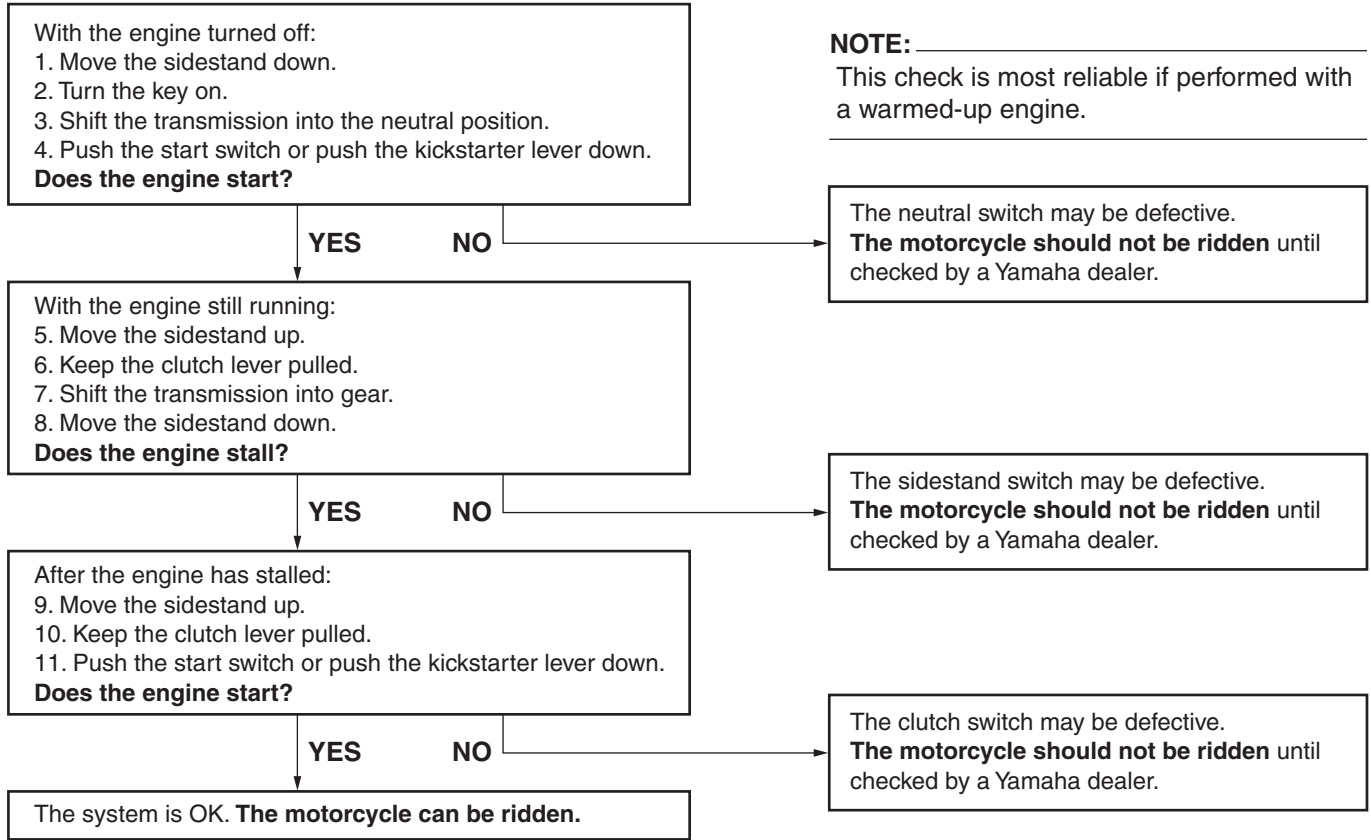

PRE-OPERATION CHECKS

EAU15592

The condition of a vehicle is the owner's responsibility. Vital components can start to deteriorate quickly and unexpectedly, even if the vehicle remains unused (for example, as a result of exposure to the elements). Any damage, fluid leakage or loss of tire air pressure could have serious consequences. Therefore, it is very important, in addition to a thorough visual inspection, to check the following points before each ride.

NOTE: _____

Pre-operation checks should be made each time the vehicle is used. Such an inspection can be accomplished in a very short time; and the added safety it assures is more than worth the time involved.

EWA11150



If any item in the Pre-operation check list is not working properly, have it inspected and repaired before operating the vehicle.

PRE-OPERATION CHECKS

EAU15605

Pre-operation check list

ITEM	CHECKS	PAGE
Fuel	<ul style="list-style-type: none">• Check fuel level in fuel tank.• Refuel if necessary.• Check fuel line for leakage.	3-6
Engine oil	<ul style="list-style-type: none">• Check oil level in engine.• If necessary, add recommended oil to specified level.• Check vehicle for oil leakage.	6-9
Front brake	<ul style="list-style-type: none">• Check operation.• If soft or spongy, have Yamaha dealer bleed hydraulic system.• Check brake pads for wear.• Replace if necessary.• Check fluid level in reservoir.• If necessary, add recommended brake fluid to specified level.• Check hydraulic system for leakage.	6-19, 6-20
Rear brake	<ul style="list-style-type: none">• Check operation.• Check pedal free play.• Adjust if necessary.	6-18, 6-19
Clutch	<ul style="list-style-type: none">• Check operation.• Lubricate cable if necessary.• Check lever free play.• Adjust if necessary.	6-16
Throttle grip	<ul style="list-style-type: none">• Make sure that operation is smooth.• Check cable free play.• If necessary, have Yamaha dealer adjust cable free play and lubricate cable and grip housing.	6-13, 6-23
Control cables	<ul style="list-style-type: none">• Make sure that operation is smooth.• Lubricate if necessary.	6-23
Drive chain	<ul style="list-style-type: none">• Check chain slack.• Adjust if necessary.• Check chain condition.• Lubricate if necessary.	6-21, 6-22

PRE-OPERATION CHECKS

ITEM	CHECKS	PAGE
Wheels and tires	<ul style="list-style-type: none">• Check for damage.• Check tire condition and tread depth.• Check air pressure.• Correct if necessary.	6-14, 6-16
Brake and shift pedals	<ul style="list-style-type: none">• Make sure that operation is smooth.• Lubricate pedal pivoting points if necessary.	6-24
Brake and clutch levers	<ul style="list-style-type: none">• Make sure that operation is smooth.• Lubricate lever pivoting points if necessary.	6-24
Centerstand, sidestand	<ul style="list-style-type: none">• Make sure that operation is smooth.• Lubricate pivots if necessary.	6-25
Chassis fasteners	<ul style="list-style-type: none">• Make sure that all nuts, bolts and screws are properly tightened.• Tighten if necessary.	—
Instruments, lights, signals and switches	<ul style="list-style-type: none">• Check operation.• Correct if necessary.	—
Sidestand switch	<ul style="list-style-type: none">• Check operation of ignition circuit cut-off system.• If system is defective, have Yamaha dealer check vehicle.	3-10
Battery	<ul style="list-style-type: none">• Check fluid level.• Fill with distilled water if necessary.	6-27

OPERATION AND IMPORTANT RIDING POINTS

EAU15950

EAU43470

EWA10270

WARNING

- **Become thoroughly familiar with all operating controls and their functions before riding. Consult a Yamaha dealer regarding any control or function that you do not thoroughly understand.**
- **Never start the engine or operate it in a closed area for any length of time. Exhaust fumes are poisonous, and inhaling them can cause loss of consciousness and death within a short time. Always make sure that there is adequate ventilation.**
- **Before starting out, make sure that the sidestand is up. If the sidestand is not raised completely, it could contact the ground and distract the operator, resulting in a possible loss of control.**

Starting a cold engine

In order for the ignition circuit cut-off system to enable starting, one of the following conditions must be met:

- The transmission is in the neutral position.
- The transmission is in gear with the clutch lever pulled and the sidestand up.

EWA10290

WARNING

- **Before starting the engine, check the function of the ignition circuit cut-off system according to the procedure described on page 3-11.**
- **Never ride with the sidestand down.**

1. Turn the fuel cock lever to “ON” or .
2. Turn the key to “ON”.
3. Shift the transmission into the neutral position.

NOTE: _____

When the transmission is in the neutral position, the neutral indicator light should be on, otherwise have a Yamaha dealer check the electrical circuit.

4. Turn the starter (choke) on and completely close the throttle. (See page 3-8.)
5. Start the engine by pushing the start switch or by pushing the kickstarter lever down.

NOTE: _____

If the engine fails to start when using the start switch, release it, wait a few seconds, and then try again. Each starting attempt should be as short as possible to preserve the battery. Do not crank the engine more than 10 seconds on any one attempt. If the engine does not start with the starter motor, try using the kickstarter.

OPERATION AND IMPORTANT RIDING POINTS

ECA11040

CAUTION:

For maximum engine life, never accelerate hard when the engine is cold!

- When the engine is warm, turn the starter (choke) off.

NOTE:

The engine is warm when it responds normally to the throttle with the starter (choke) turned off.

EAU16640

Starting a warm engine

Follow the same procedure as for starting a cold engine with the exception that the starter (choke) is not required when the engine is warm.

EAU16671

Shifting

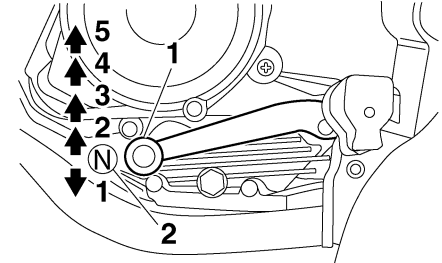

- Shift pedal
- Neutral position

Shifting gears lets you control the amount of engine power available for starting off, accelerating, climbing hills, etc.

The gear positions are shown in the illustration.

NOTE:

To shift the transmission into the neutral position, press the shift pedal down repeatedly until it reaches the end of its travel, and then slightly raise it.

OPERATION AND IMPORTANT RIDING POINTS

ECA10260

CAUTION:

- Even with the transmission in the neutral position, do not coast for long periods of time with the engine off, and do not tow the motorcycle for long distances. The transmission is properly lubricated only when the engine is running. Inadequate lubrication may damage the transmission.
 - Always use the clutch while changing gears to avoid damaging the engine, transmission, and drive train, which are not designed to withstand the shock of forced shifting.
-

EAU16800

Tips for reducing fuel consumption

Fuel consumption depends largely on your riding style. Consider the following tips to reduce fuel consumption:

- Turn the starter (choke) off as soon as possible.
- Shift up swiftly, and avoid high engine speeds during acceleration.
- Do not rev the engine while shifting down, and avoid high engine speeds with no load on the engine.
- Turn the engine off instead of letting it idle for an extended length of time (e.g., in traffic jams, at traffic lights or at railroad crossings).

EAU16830

Engine break-in

There is never a more important period in the life of your engine than the period between 0 and 1000 km (600 mi). For this reason, you should read the following material carefully.

Since the engine is brand new, do not put an excessive load on it for the first 1000 km (600 mi). The various parts in the engine wear and polish themselves to the correct operating clearances. During this period, prolonged full-throttle operation or any condition that might result in engine overheating must be avoided.

EAU37250

0–500 km (0–300 mi)

Avoid prolonged operation above 6000 r/min.

After every hour of operation, stop the engine, and then let it cool for five to ten minutes.

Vary the engine speed from time to time. Do not operate the engine at one set throttle position.

OPERATION AND IMPORTANT RIDING POINTS

500–1000 km (300–600 mi)

Avoid prolonged operation above 7500 r/min.

Rev the engine freely through the gears, but do not use full throttle at any time.

ECA10280

CAUTION:

After 1000 km (600 mi) of operation, the engine oil must be changed.

1000 km (600 mi) and beyond

The vehicle can now be operated normally.

ECA10310

CAUTION:

- Keep the engine speed out of the tachometer red zone.
- If any engine trouble should occur during the engine break-in period, immediately have a Yamaha dealer check the vehicle.

EAU37200

Parking

When parking, stop the engine, remove the key from the main switch, and then turn the fuel cock lever to “OFF” or “●”.

EWA10310

WARNING

- Since the engine and exhaust system can become very hot, park in a place where pedestrians or children are not likely to touch them.
- Do not park on a slope or on soft ground, otherwise the vehicle may overturn.

ECA10380

CAUTION:

Never park in an area where there are fire hazards such as grass or other flammable materials.

PERIODIC MAINTENANCE AND MINOR REPAIR

EAU17240

EAU17340

EWA10350

Safety is an obligation of the owner. Periodic inspection, adjustment and lubrication will keep your vehicle in the safest and most efficient condition possible. The most important points of inspection, adjustment, and lubrication are explained on the following pages. The intervals given in the periodic maintenance and lubrication chart should be simply considered as a general guide under normal riding conditions. However, DEPENDING ON THE WEATHER, TERRAIN, GEOGRAPHICAL LOCATION, AND INDIVIDUAL USE, THE MAINTENANCE INTERVALS MAY NEED TO BE SHORTENED.

6

! WARNING

If you are not familiar with maintenance work, have a Yamaha dealer do it for you.

EWA10320

Owner's tool kit

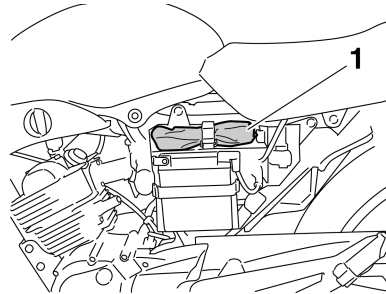

1. Owner's tool kit

The owner's tool kit is located behind panel B. (See page 6-6.)

The service information included in this manual and the tools provided in the owner's tool kit are intended to assist you in the performance of preventive maintenance and minor repairs. However, additional tools such as a torque wrench may be necessary to perform certain maintenance work correctly.

NOTE:

If you do not have the tools or experience required for a particular job, have a Yamaha dealer perform it for you.

! WARNING

Modifications not approved by Yamaha may cause loss of performance and render the vehicle unsafe for use. Consult a Yamaha dealer before attempting any changes.

PERIODIC MAINTENANCE AND MINOR REPAIR

EAU17711

Periodic maintenance and lubrication chart

NOTE:

- The annual checks must be performed every year, except if a kilometer-based maintenance is performed instead.
- From 30000 km, repeat the maintenance intervals starting from 6000 km.
- Items marked with an asterisk should be performed by a Yamaha dealer as they require special tools, data and technical skills.

NO.	ITEM	CHECK OR MAINTENANCE JOB	ODOMETER READING (× 1000 km)					ANNUAL CHECK
			1	6	12	18	24	
1	* Fuel line	• Check fuel hoses for cracks or damage.		√	√	√	√	√
2	* Fuel cock filter	• Check condition.			√		√	
3	Spark plug	• Check condition. • Clean and regap.		√		√		
		• Replace.			√		√	
4	* Valves	• Check valve clearance. • Adjust.		√	√	√	√	
5	Air filter element	• Clean.		√		√		
		• Replace.			√		√	
6	* Battery	• Check electrolyte level and specific gravity. • Make sure that the breather hose is properly routed.		√	√	√	√	√
7	Clutch	• Check operation. • Adjust.	√	√	√	√	√	
8	* Front brake	• Check operation, fluid level and vehicle for fluid leakage.	√	√	√	√	√	√
		• Replace brake pads.	Whenever worn to the limit					

PERIODIC MAINTENANCE AND MINOR REPAIR

NO.	ITEM	CHECK OR MAINTENANCE JOB	ODOMETER READING (× 1000 km)					ANNUAL CHECK
			1	6	12	18	24	
9	* Rear brake	• Check operation and adjust brake pedal free play.	√	√	√	√	√	√
		• Replace brake shoes.	Whenever worn to the limit					
10	* Brake hose	• Check for cracks or damage.		√	√	√	√	√
		• Replace.	Every 4 years					
11	* Wheels	• Check runout and for damage.		√	√	√	√	
12	* Tires	• Check tread depth and for damage. • Replace if necessary. • Check air pressure. • Correct if necessary.		√	√	√	√	√
13	* Wheel bearings	• Check bearing for looseness or damage.		√	√	√	√	
14	* Swingarm pivot bushes	• Check bush assemblies for looseness.		√	√	√	√	
		• Lubricate with lithium-soap-based grease.	Every 50000 km					
15	Drive chain	• Check chain slack, alignment and condition. • Adjust and lubricate chain with a special O-ring chain lubricant thoroughly.	Every 1000 km and after washing the motorcycle or riding in the rain					
16	* Steering bearings	• Check bearing play and steering for roughness.	√	√	√	√	√	
		• Lubricate with lithium-soap-based grease.	Every 24000 km					
17	* Chassis fasteners	• Make sure that all nuts, bolts and screws are properly tightened.		√	√	√	√	√
18	Brake and clutch lever pivot shafts	• Lubricate with lithium-soap-based grease.		√	√	√	√	√
19	Brake and shift pedal pivot shafts	• Lubricate with lithium-soap-based grease.		√	√	√	√	√
20	Sidestand, centerstand	• Check operation. • Lubricate.		√	√	√	√	√

PERIODIC MAINTENANCE AND MINOR REPAIR

NO.	ITEM	CHECK OR MAINTENANCE JOB	ODOMETER READING (× 1000 km)					ANNUAL CHECK
			1	6	12	18	24	
21	* Sidestand switch	• Check operation.	√	√	√	√	√	√
22	* Front fork	• Check operation and for oil leakage.		√	√	√	√	
23	* Shock absorber assemblies	• Check operation and shock absorbers for oil leakage.		√	√	√	√	
24	* Carburetor	• Check starter (choke) operation. • Adjust engine idling speed.	√	√	√	√	√	√
25	Engine oil	• Change. • Check oil level and vehicle for oil leakage.	√	√	√	√	√	√
26	* Front and rear brake switches	• Check operation.	√	√	√	√	√	√
27	Moving parts and cables	• Lubricate.		√	√	√	√	√
28	* Throttle grip housing and cable	• Check operation and free play. • Adjust the throttle cable free play if necessary. • Lubricate the throttle grip housing and cable.		√	√	√	√	√
29	* Air induction system	• Check the air cut-off valve, reed valve, and hose for damage. • Replace any damaged parts if necessary.		√	√	√	√	√
30	* Lights, signals and switches	• Check operation. • Adjust headlight beam.	√	√	√	√	√	√

NOTE:

- The air filter needs more frequent service if you are riding in unusually wet or dusty areas.
- Hydraulic brake service
 - Regularly check and, if necessary, correct the brake fluid level.

PERIODIC MAINTENANCE AND MINOR REPAIR

- Every two years replace the internal components of the brake master cylinder and caliper, and change the brake fluid.
 - Replace the brake hoses every four years and if cracked or damaged.
-

PERIODIC MAINTENANCE AND MINOR REPAIR

Removing and installing panels

EAU18771

The panels shown need to be removed to perform some of the maintenance jobs described in this chapter. Refer to this section each time a panel needs to be removed and installed.

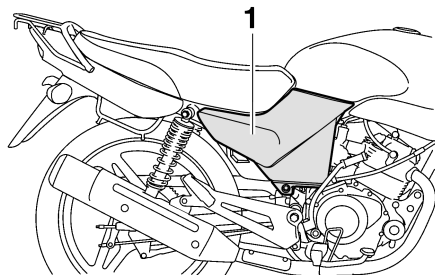

1. Panel A

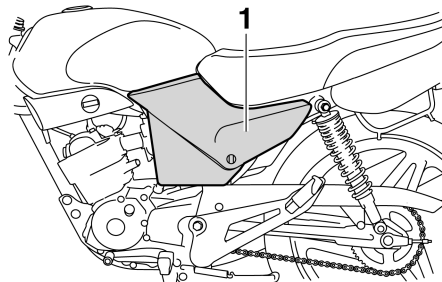

1. Panel B

Panel A

EAU37070

To remove the panel

1. Remove the screw.

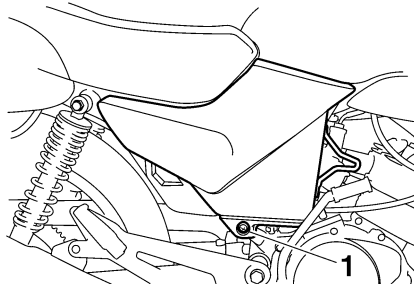

1. Screw

2. Pull the front of the panel out, and then slide the panel forward to release it in the rear.

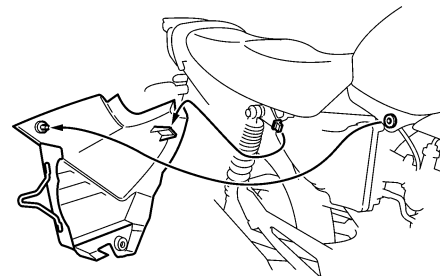

To install the panel

1. Secure the rear of the panel, and then push the front of the panel in.

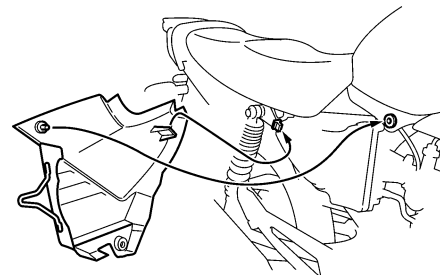

2. Install the screw.

PERIODIC MAINTENANCE AND MINOR REPAIR

Panel B

EAU36961

To remove the panel

1. Slide the panel lock cover open, insert the key into the lock, and then turn it 1/4 turn clockwise.

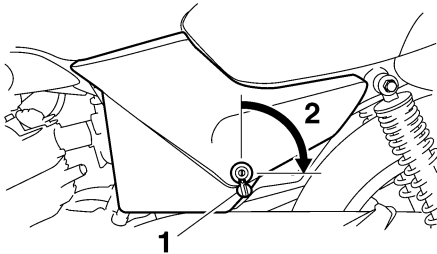

1. Panel lock cover
2. Unlock.

2. Pull the front of the panel out with the key inserted in the lock, and then slide the panel forward to release it in the rear.

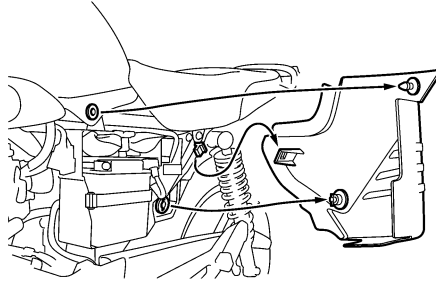

To install the panel

1. Secure the rear of the panel, and then push the front of the panel in with the key inserted in the lock.

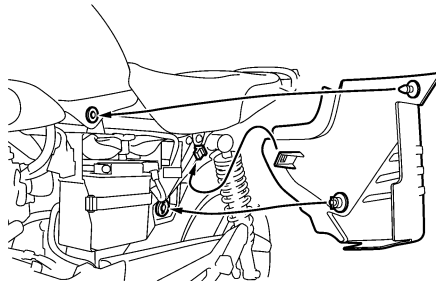

2. While pushing the panel inward, turn the key counterclockwise to the original position, remove it, and then close the panel lock cover.

EAU19603

Checking the spark plug

The spark plug is an important engine component, which is easy to check. Since heat and deposits will cause any spark plug to slowly erode, the spark plug should be removed and checked in accordance with the periodic maintenance and lubrication chart. In addition, the condition of the spark plug can reveal the condition of the engine.

To remove the spark plug

1. Remove the spark plug cap.

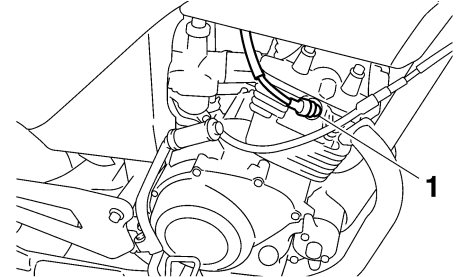

1. Spark plug cap

2. Remove the spark plug as shown, with the spark plug wrench included in the owner's tool kit.

PERIODIC MAINTENANCE AND MINOR REPAIR

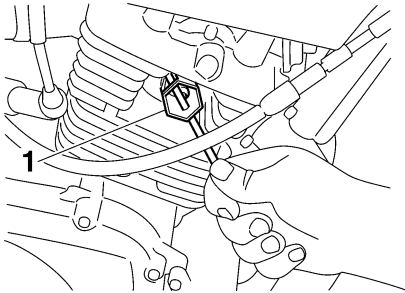

1. Spark plug wrench

To check the spark plug

1. Check that the porcelain insulator around the center electrode of the spark plug is a medium-to-light tan (the ideal color when the vehicle is ridden normally).

NOTE:

If the spark plug shows a distinctly different color, the engine could be operating improperly. Do not attempt to diagnose such problems yourself. Instead, have a Yamaha dealer check the vehicle.

2. Check the spark plug for electrode erosion and excessive carbon or other deposits, and replace it if necessary.

Specified spark plug:
NGK/CR6HSA

To install the spark plug

1. Measure the spark plug gap with a wire thickness gauge and, if necessary, adjust the gap to specification.

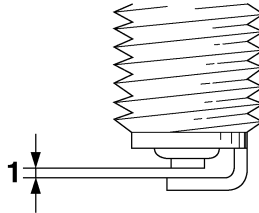

1. Spark plug gap

Spark plug gap:
0.6–0.7 mm (0.024–0.028 in)

2. Clean the surface of the spark plug gasket and its mating surface, and then wipe off any grime from the spark plug threads.
3. Install the spark plug with the spark plug wrench, and then tighten it to the specified torque.

Tightening torque:

Spark plug:
12.5 Nm (1.25 m·kgf, 9.0 ft·lbf)

NOTE:

If a torque wrench is not available when installing a spark plug, a good estimate of the correct torque is 1/4–1/2 turn past finger tight. However, the spark plug should be tightened to the specified torque as soon as possible.

4. Install the spark plug cap.

PERIODIC MAINTENANCE AND MINOR REPAIR

EAU37170

Engine oil

The engine oil level should be checked before each ride. In addition, the oil must be changed at the intervals specified in the periodic maintenance and lubrication chart.

To check the engine oil level

1. Place the vehicle on the center-stand.

NOTE:

Make sure that the vehicle is positioned straight up when checking the oil level. A slight tilt to the side can result in a false reading.

2. Start the engine, warm it up for several minutes, and then turn it off.
3. Wait a few minutes until the oil settles, remove the oil filler cap, wipe the dipstick clean, insert it back into the oil filler hole (without screwing it in), and then remove it again to check the oil level.

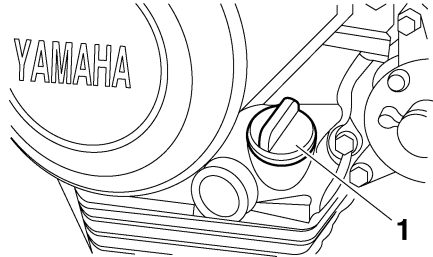

1. Engine oil filler cap

NOTE:

The engine oil should be between the minimum and maximum level marks.

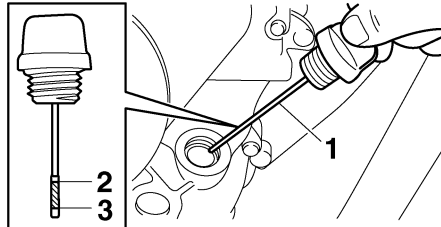

1. Dipstick
2. Maximum level mark
3. Minimum level mark

4. If the engine oil is at or below the minimum level mark, add sufficient oil of the recommended type to raise it to the correct level.
5. Insert the dipstick into the oil filler hole, and then tighten the oil filler cap.

To change the engine oil

1. Start the engine, warm it up for several minutes, and then turn it off.
2. Place an oil pan under the engine to collect the used oil.
3. Remove the engine oil filler cap and drain bolt to drain the oil from the crankcase.

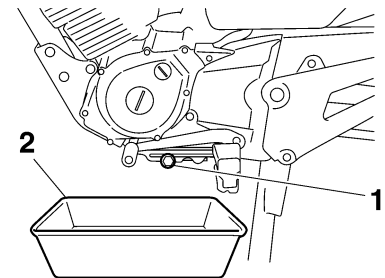

1. Engine oil drain bolt
2. Oil pan

PERIODIC MAINTENANCE AND MINOR REPAIR

4. Install the engine oil drain bolt, and then tighten it to the specified torque.

Tightening torque:

Engine oil drain bolt:
20 Nm (2.0 m·kgf, 14 ft·lbf)

5. Add the specified amount of the recommended engine oil, and then install and tighten the engine oil filler cap.

Recommended engine oil:
See page 8-1.
Oil change quantity:
1.00 L (1.06 US qt) (0.88 Imp.qt)

ECA11620

CAUTION:

- In order to prevent clutch slippage (since the engine oil also lubricates the clutch), do not mix any chemical additives. Do not use oils with a diesel specification of “CD” or oils of a higher quality than specified. In addition, do not use oils labeled “ENERGY CONSERVING II” or higher.

- Make sure that no foreign material enters the crankcase.

6. Start the engine, and then let it idle for several minutes while checking it for oil leakage. If oil is leaking, immediately turn the engine off and check for the cause.
7. Turn the engine off, and then check the oil level and correct it if necessary.

EAU37121

Cleaning the air filter element

The air filter element should be cleaned at the intervals specified in the periodic maintenance and lubrication chart. Clean the air filter element more frequently if you are riding in unusually wet or dusty areas.

1. Remove panel A. (See page 6-6.)
2. Remove the air filter case cover by removing the screws.

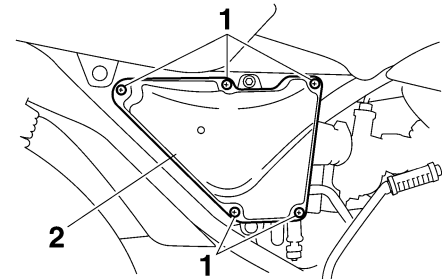

1. Screw
2. Air filter case cover
3. Remove the air filter element.

PERIODIC MAINTENANCE AND MINOR REPAIR

EWA10430

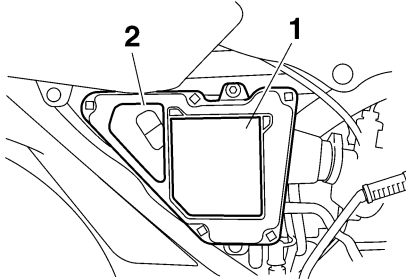

1. Sponge material
2. Air filter element

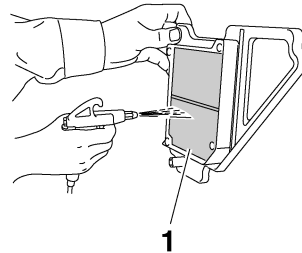

1. Air filter element

4. Remove the sponge material from the air filter element.
5. Lightly tap the air filter element to remove most of the dust and dirt, and then blow the remaining dirt out with compressed air on the mesh side as shown. If the air filter element is damaged, replace it.

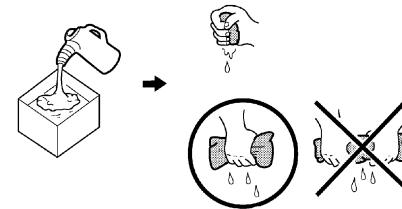

6. Clean the sponge material with solvent, then squeeze the remaining solvent out, and be sure to let the sponge material dry before installing it into the air filter element. If the sponge material is damaged, replace it.

! WARNING

Use only a dedicated parts cleaning solvent. To avoid the risk of fire or explosion, do not use gasoline or solvents with a low flash point.

ECA15100

CAUTION:

To avoid damaging the sponge material, handle it gently and carefully, and do not twist it.

7. Install the sponge material into the air filter element, and then install the air filter element into the air filter case.

ECA10480

CAUTION:

- Make sure that the air filter element is properly seated in the air filter case.
- The engine should never be operated without the air filter element installed, otherwise the piston(s) and/or cylinder(s) may become excessively worn.

8. Install the air filter case cover by installing the screws.

9. Check the hose at the bottom of the air filter case for accumulated dust or water, and if necessary, drain it by removing the clamp, and then removing the plug.

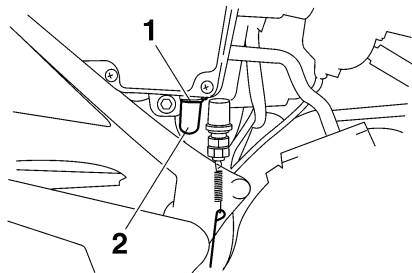

1. Clamp
2. Air filter check hose plug

10. Install the plug into the check hose, and then install the clamp.
11. Install the panel.

Adjusting the carburetor

EAU21280

The carburetor is an important part of the engine and requires very sophisticated adjustment. Therefore, most carburetor adjustments should be left to a Yamaha dealer, who has the necessary professional knowledge and experience. The adjustment described in the following section, however, may be serviced by the owner as part of routine maintenance.

CAUTION:

ECA10550

The carburetor has been set and extensively tested at the Yamaha factory. Changing these settings without sufficient technical knowledge may result in poor performance of or damage to the engine.

Adjusting the engine idling speed

EAU21320

The engine idling speed must be checked and, if necessary, adjusted as follows at the intervals specified in the periodic maintenance and lubrication chart.

The engine should be warm before making this adjustment.

NOTE:

The engine is warm when it quickly responds to the throttle.

Check the engine idling speed and, if necessary, adjust it to specification by turning the throttle stop screw. To increase the engine idling speed, turn the screw in direction (a). To decrease the engine idling speed, turn the screw in direction (b).

PERIODIC MAINTENANCE AND MINOR REPAIR

EAU21370

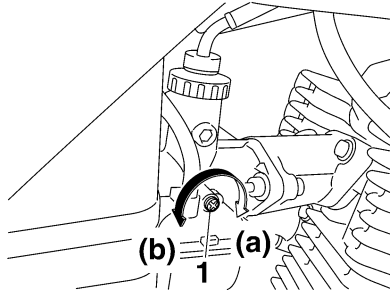

1. Throttle stop screw

Engine idling speed:
1300–1500 r/min

6

NOTE: _____
If the specified idling speed cannot be obtained as described above, have a Yamaha dealer make the adjustment.

Adjusting the throttle cable free play

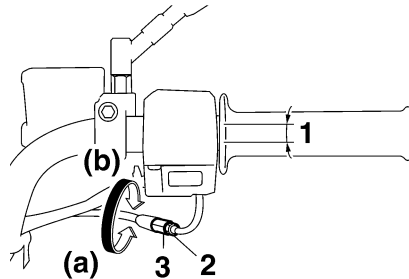

1. Throttle cable free play
2. Locknut
3. Throttle cable free play adjusting nut

The throttle cable free play should measure 3.0–7.0 mm (0.12–0.28 in) at the throttle grip. Periodically check the throttle cable free play and, if necessary, adjust it as follows.

NOTE: _____
The engine idling speed must be correctly adjusted before checking and adjusting the throttle cable free play.

1. Loosen the locknut.

2. To increase the throttle cable free play, turn the adjusting nut in direction (a). To decrease the throttle cable free play, turn the adjusting nut in direction (b).
3. Tighten the locknut.

PERIODIC MAINTENANCE AND MINOR REPAIR

Valve clearance

EAU21401

The valve clearance changes with use, resulting in improper air-fuel mixture and/or engine noise. To prevent this from occurring, the valve clearance must be adjusted by a Yamaha dealer at the intervals specified in the periodic maintenance and lubrication chart.

Tires

EAU21561

To maximize the performance, durability, and safe operation of your motorcycle, note the following points regarding the specified tires.

Tire air pressure

The tire air pressure should be checked and, if necessary, adjusted before each ride.

EWA10500

WARNING

- The tire air pressure must be checked and adjusted on cold tires (i.e., when the temperature of the tires equals the ambient temperature).
- The tire air pressure must be adjusted in accordance with the riding speed and with the total weight of rider, passenger, cargo, and accessories approved for this model.

Tire air pressure (measured on cold tires):

0–90 kg (0–198 lb):

Front:

175 kPa (25 psi) (1.75 kgf/cm²)

Rear:

200 kPa (29 psi) (2.00 kgf/cm²)

90–198 kg (198–437 lb):

Front:

175 kPa (25 psi) (1.75 kgf/cm²)

Rear:

280 kPa (41 psi) (2.80 kgf/cm²)

Maximum load*:

198 kg (437 lb)

* Total weight of rider, passenger, cargo and accessories

EWA11020

WARNING

Because loading has an enormous impact on the handling, braking, performance and safety characteristics of your motorcycle, you should keep the following precautions in mind.

- **NEVER OVERLOAD THE MOTORCYCLE!** Operation of an overloaded motorcycle may result in tire damage, loss of control, or severe injury. Make sure that the total weight of rider,

PERIODIC MAINTENANCE AND MINOR REPAIR

passenger, cargo, and accessories does not exceed the specified maximum load for the vehicle.

- Do not carry along loosely packed items, which can shift during a ride.
- Securely pack the heaviest items close to the center of the motorcycle and distribute the weight evenly on both sides.
- Adjust the suspension and tire air pressure with regard to the load.
- Check the tire condition and air pressure before each ride.

Tire inspection

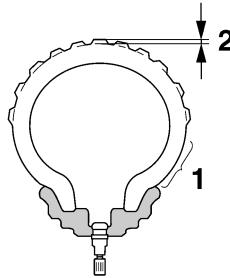

1. Tire sidewall
2. Tire tread depth

The tires must be checked before each ride. If the center tread depth reaches the specified limit, if the tire has a nail or glass fragments in it, or if the sidewall is cracked, have a Yamaha dealer replace the tire immediately.

Minimum tire tread depth (front and rear):
1.6 mm (0.06 in)

NOTE:

The tire tread depth limits may differ from country to country. Always comply with the local regulations.

Tire information

This motorcycle is equipped with cast wheels and tubeless tires.

EWA10460

! WARNING

- The front and rear tires should be of the same make and design, otherwise the handling characteristics of the vehicle cannot be guaranteed.
- After extensive tests, only the tires listed below have been approved for this model by Yamaha Motor Co., Ltd.

Front tire:

Size:
2.75-18 42P
Manufacturer/model:
CHENG SHIN/C-910

Rear tire:

Size:
90/90-18 57P
Manufacturer/model:
CHENG SHIN/C-905

WARNING

EWA10470

- Have a Yamaha dealer replace excessively worn tires. Besides being illegal, operating the vehicle with excessively worn tires decreases riding stability and can lead to loss of control.
- The replacement of all wheel and brake related parts, including the tires, should be left to a Yamaha dealer, who has the necessary professional knowledge and experience.

Cast wheels

EAU21960

To maximize the performance, durability, and safe operation of your vehicle, note the following points regarding the specified wheels.

- The wheel rims should be checked for cracks, bends or warpage before each ride. If any damage is found, have a Yamaha dealer replace the wheel. Do not attempt even the smallest repair to the wheel. A deformed or cracked wheel must be replaced.
- The wheel should be balanced whenever either the tire or wheel has been changed or replaced. An unbalanced wheel can result in poor performance, adverse handling characteristics, and a shortened tire life.
- Ride at moderate speeds after changing a tire since the tire surface must first be “broken in” for it to develop its optimal characteristics.

EAU22041

Adjusting the clutch lever free play

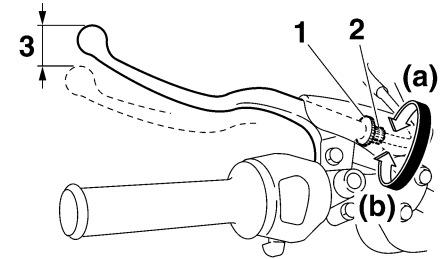

1. Locknut
2. Clutch lever free play adjusting bolt
3. Clutch lever free play

The clutch lever free play should measure 10.0–15.0 mm (0.39–0.59 in) as shown. Periodically check the clutch lever free play and, if necessary, adjust it as follows.

1. Loosen the locknut at the clutch lever.
2. To increase the clutch lever free play, turn the adjusting bolt in direction (a). To decrease the clutch lever free play, turn the adjusting bolt in direction (b).

PERIODIC MAINTENANCE AND MINOR REPAIR

NOTE:

If the specified clutch lever free play could be obtained as described above, tighten the locknut and skip the rest of the procedure, otherwise proceed as follows.

3. Fully turn the adjusting bolt at the clutch lever in direction (a) to loosen the clutch cable.
4. Loosen the locknut at the crankcase.

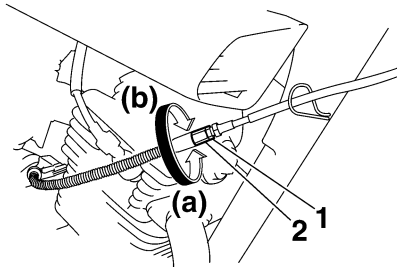

1. Locknut (crankcase)
2. Clutch lever free play adjusting nut (crankcase)

5. To increase the clutch lever free play, turn the adjusting nut in direction (a). To decrease the clutch lever free play, turn the adjusting nut in direction (b).
6. Tighten the locknut at the clutch lever and the crankcase.

Checking the front brake lever free play

EAUT1220

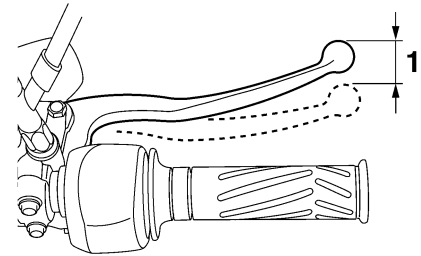

1. Brake lever free play

The brake lever free play should measure 0.0–7.0 mm (0.00–0.28 in) as shown. Periodically check the brake lever free play and, if necessary, have a Yamaha dealer check the brake system.

EWA10640

⚠ WARNING

An incorrect brake lever free play indicates a hazardous condition in the brake system. Do not operate the motorcycle until the brake system has been checked or repaired by a Yamaha dealer.

Adjusting the brake pedal free play

EAU39811

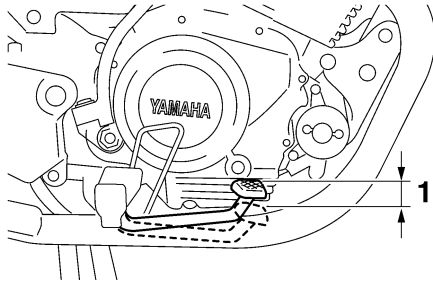

1. Brake pedal free play

The brake pedal free play should measure 20.0–30.0 mm (0.79–1.18 in) at the brake pedal end as shown. Periodically check the brake pedal free play and, if necessary, adjust it as follows. To increase the brake pedal free play, turn the adjusting nut at the brake rod in direction (a). To decrease the brake pedal free play, turn the adjusting nut in direction (b).

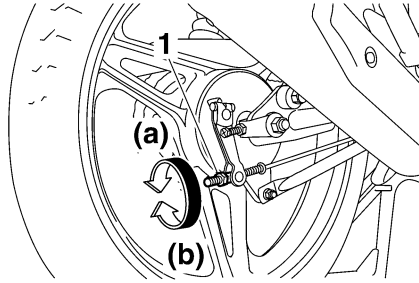

1. Brake pedal free play adjusting nut

Adjusting the rear brake light switch

EAU22291

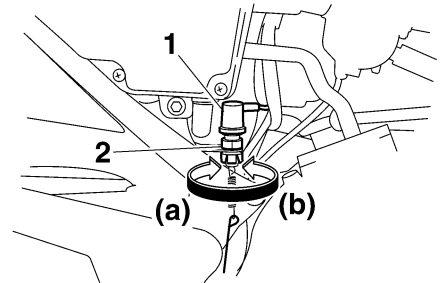

1. Rear brake light switch
2. Rear brake light switch adjusting nut

The rear brake light switch, which is activated by the brake pedal, is properly adjusted when the brake light comes on just before braking takes effect. If necessary, adjust the brake light switch as follows.

1. Remove panel A. (See page 6-6.)
2. Turn the adjusting nut while holding the rear brake light switch in place. To make the brake light come on earlier, turn the adjusting nut in direction (a). To make the brake light come on later, turn the adjusting nut in direction (b).

PERIODIC MAINTENANCE AND MINOR REPAIR

3. Install the panel.

Checking the front brake pads and rear brake shoes

EAU22380

The front brake pads and the rear brake shoes must be checked for wear at the intervals specified in the periodic maintenance and lubrication chart.

Front brake pads

EAU22430

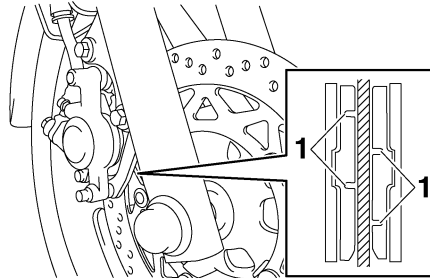

1. Brake pad wear indicator groove

Each front brake pad is provided with wear indicator grooves, which allow you to check the brake pad wear without having to disassemble the brake. To check the brake pad wear, check the wear indicator grooves. If a brake pad has worn to the point that the wear

indicator grooves have almost disappeared, have a Yamaha dealer replace the brake pads as a set.

Rear brake shoes

EAU43170

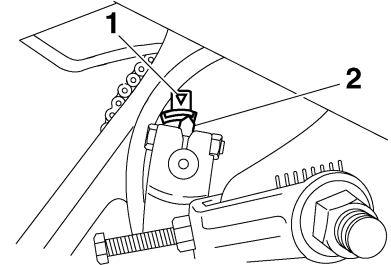

1. Brake shoe wear limit mark
2. Brake shoe wear indicator

The rear brake is provided with a wear indicator, which allows you to check the brake shoe wear without having to disassemble the brake. To check the brake shoe wear, check the position of the wear indicator while applying the brake. If a brake shoe has worn to the point that the wear indicator reaches the wear limit mark, have a Yamaha dealer replace the brake shoes as a set.

PERIODIC MAINTENANCE AND MINOR REPAIR

Checking the front brake fluid level

EAU37001

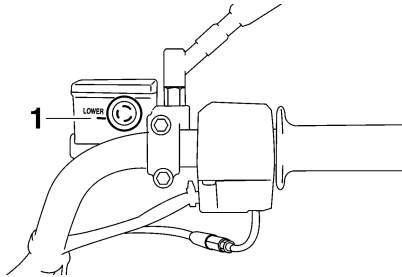

1. Minimum level mark

Insufficient brake fluid may allow air to enter the brake system, possibly causing it to become ineffective.

Before riding, check that the brake fluid is above the minimum level mark and replenish if necessary. A low brake fluid level may indicate worn brake pads and/or brake system leakage. If the brake fluid level is low, be sure to check the brake pads for wear and the brake system for leakage.

Observe these precautions:

- When checking the fluid level, make sure that the top of the master cylinder is level by turning the handlebars.
- Use only the recommended quality brake fluid, otherwise the rubber seals may deteriorate, causing leakage and poor braking performance.

Recommended brake fluid:
DOT 4

NOTE: _____
If DOT 4 is not available, DOT 3 can be used.

- Refill with the same type of brake fluid. Mixing fluids may result in a harmful chemical reaction and lead to poor braking performance.
- Be careful that water does not enter the master cylinder when refilling. Water will significantly lower the boiling point of the fluid and may result in vapor lock.

- Brake fluid may deteriorate painted surfaces or plastic parts. Always clean up spilled fluid immediately.
- As the brake pads wear, it is normal for the brake fluid level to gradually go down. However, if the brake fluid level goes down suddenly, have a Yamaha dealer check the cause.

PERIODIC MAINTENANCE AND MINOR REPAIR

Changing the brake fluid

EAU22720

Have a Yamaha dealer change the brake fluid at the intervals specified in the NOTE after the periodic maintenance and lubrication chart. In addition, have the oil seals of the brake master cylinder and caliper as well as the brake hose replaced at the intervals listed below or whenever they are damaged or leaking.

- Oil seals: Replace every two years.
- Brake hose: Replace every four years.

6

Drive chain slack

EAU22760

The drive chain slack should be checked before each ride and adjusted if necessary.

To check the drive chain slack

EAU22793

1. Place the motorcycle on the centerstand.
2. Shift the transmission into the neutral position.
3. Spin the rear wheel several times to locate the tightest portion of the drive chain.
4. Measure the drive chain slack as shown.

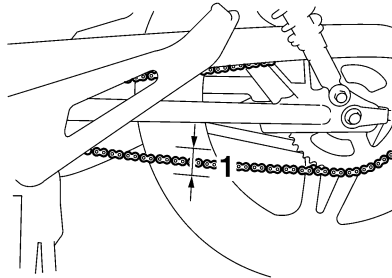

1. Drive chain slack

Drive chain slack:

20.0–30.0 mm (0.79–1.18 in)

5. If the drive chain slack is incorrect, adjust it as follows.

To adjust the drive chain slack

EAU37112

1. Loosen the brake pedal free play adjusting nut, brake torque rod nut, and axle nut.

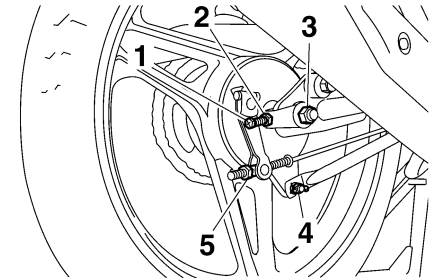

1. Drive chain slack adjusting bolt
2. Chain puller locknut
3. Axle nut
4. Brake torque rod nut
5. Brake pedal free play adjusting nut

2. Loosen the chain puller locknut at each end of the swingarm.

PERIODIC MAINTENANCE AND MINOR REPAIR

- To tighten the drive chain, turn the adjusting bolt at each end of the swingarm in direction (a). To loosen the drive chain, turn the adjusting bolt at each end of the swingarm in direction (b), and then push the rear wheel forward.

NOTE: _____
Using the alignment marks on each side of the swingarm, make sure that both chain pullers are in the same position for proper wheel alignment.

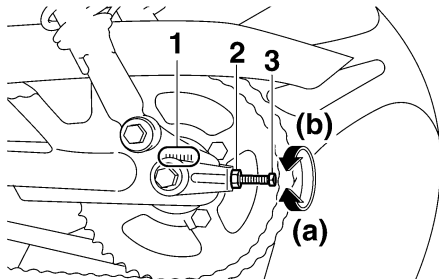

- Alignment marks
- Chain puller locknut
- Drive chain slack adjusting bolt

ECA10570

CAUTION: _____

Improper drive chain slack will overload the engine as well as other vital parts of the motorcycle and can lead to chain slippage or breakage. To prevent this from occurring, keep the drive chain slack within the specified limits.

- Tighten both locknuts, and then tighten the axle nut and brake torque rod nut to their specified torques.

Tightening torques:

- Axle nut:
80 Nm (8.0 m·kgf, 58 ft·lbf)
- Brake torque rod nut:
19 Nm (1.9 m·kgf, 13 ft·lbf)

- Adjust the brake pedal free play. (See page 6-18.)

EWA10660

⚠ WARNING _____

After adjusting the brake pedal free play, check the operation of the brake light.

EAU23022

Cleaning and lubricating the drive chain

The drive chain must be cleaned and lubricated at the intervals specified in the periodic maintenance and lubrication chart, otherwise it will quickly wear out, especially when riding in dusty or wet areas. Service the drive chain as follows.

ECA10581

CAUTION: _____

The drive chain must be lubricated after washing the motorcycle and riding in the rain.

- Clean the drive chain with kerosene and a small soft brush.

ECA11120

CAUTION: _____

To prevent damaging the O-rings, do not clean the drive chain with steam cleaners, high-pressure washers or inappropriate solvents.

- Wipe the drive chain dry.
- Thoroughly lubricate the drive chain with a special O-ring chain lubricant.

PERIODIC MAINTENANCE AND MINOR REPAIR

CAUTION:

ECA11110

Do not use engine oil or any other lubricants for the drive chain, as they may contain substances that could damage the O-rings.

Checking and lubricating the cables

EAU23100

The operation of all control cables and the condition of the cables should be checked before each ride, and the cables and cable ends should be lubricated if necessary. If a cable is damaged or does not move smoothly, have a Yamaha dealer check or replace it.

Recommended lubricant:
Engine oil

EWA10720

WARNING

Damage to the outer sheath may interfere with proper cable operation and will cause the inner cable to rust. Replace a damaged cable as soon as possible to prevent unsafe conditions.

Checking and lubricating the throttle grip and cable

EAU23111

The operation of the throttle grip should be checked before each ride. In addition, the cable should be lubricated at the intervals specified in the periodic maintenance chart.

PERIODIC MAINTENANCE AND MINOR REPAIR

Checking and lubricating the brake and shift pedals

EAU23131

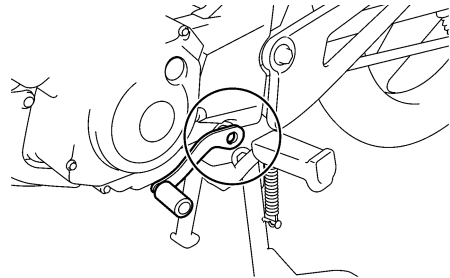
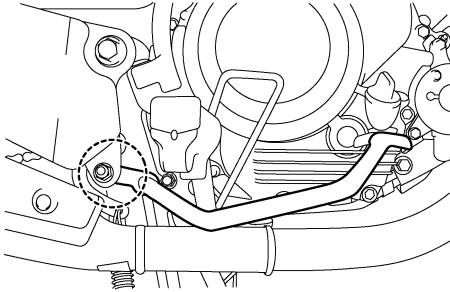

The operation of the brake and shift pedals should be checked before each ride, and the pedal pivots should be lubricated if necessary.

Recommended lubricant:
Lithium-soap-based grease (all-purpose grease)

Checking and lubricating the brake and clutch levers

EAU23140

Brake lever

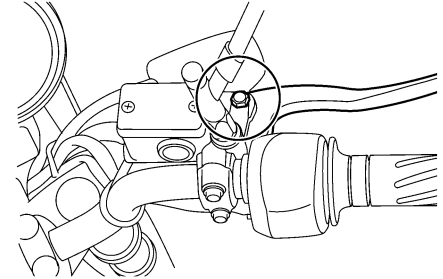

Clutch lever

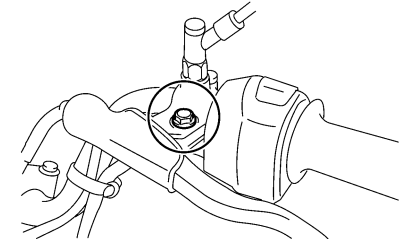

The operation of the brake and clutch levers should be checked before each ride, and the lever pivots should be lubricated if necessary.

PERIODIC MAINTENANCE AND MINOR REPAIR

Recommended lubricant:

Lithium-soap-based grease (all-purpose grease)

Checking and lubricating the centerstand and sidestand

EAU23211

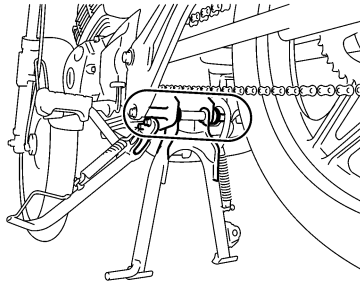

The operation of the centerstand and sidestand should be checked before each ride, and the pivots and metal-to-metal contact surfaces should be lubricated if necessary.

EWA10740

WARNING

If the centerstand or sidestand does not move up and down smoothly, have a Yamaha dealer check or repair it.

Recommended lubricant:

Lithium-soap-based grease (all-purpose grease)

Lubricating the swingarm pivots

EAUM1650

The swingarm pivots must be lubricated at the intervals specified in the periodic maintenance and lubrication chart.

Recommended lubricant:

Lithium-soap-based grease

EAU23271

Checking the front fork

The condition and operation of the front fork must be checked as follows at the intervals specified in the periodic maintenance and lubrication chart.

To check the condition

EWA10750

WARNING

Securely support the vehicle so that there is no danger of it falling over.

Check the inner tubes for scratches, damage and excessive oil leakage.

To check the operation

1. Place the vehicle on a level surface and hold it in an upright position.
2. While applying the front brake, push down hard on the handlebars several times to check if the front fork compresses and rebounds smoothly.

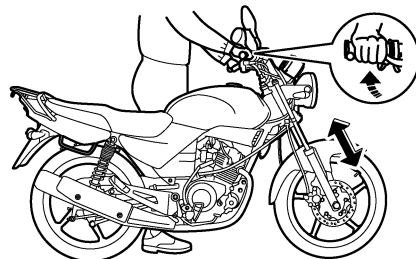

ECA10590

CAUTION:

If any damage is found or the front fork does not operate smoothly, have a Yamaha dealer check or repair it.

EAU23280

Checking the steering

Worn or loose steering bearings may cause danger. Therefore, the operation of the steering must be checked as follows at the intervals specified in the periodic maintenance and lubrication chart.

1. Place a stand under the engine to raise the front wheel off the ground.

EWA10750

WARNING

Securely support the vehicle so that there is no danger of it falling over.

2. Hold the lower ends of the front fork legs and try to move them forward and backward. If any free play can be felt, have a Yamaha dealer check or repair the steering.

PERIODIC MAINTENANCE AND MINOR REPAIR

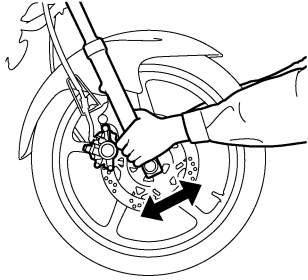

EAU23290

Checking the wheel bearings

The front and rear wheel bearings must be checked at the intervals specified in the periodic maintenance and lubrication chart. If there is play in the wheel hub or if the wheel does not turn smoothly, have a Yamaha dealer check the wheel bearings.

EAU23321

Battery

A poorly maintained battery will corrode and discharge quickly. The electrolyte level, battery lead connections and breather hose routing should be checked before each ride and at the intervals specified in the periodic maintenance and lubrication chart.

To check the electrolyte level

1. Place the vehicle on a level surface and hold it in an upright position.

NOTE: _____

Make sure that the vehicle is positioned straight up when checking the electrolyte level.

2. Remove panel B. (See page 6-6.)
3. Check the electrolyte level in the battery.

NOTE: _____

The electrolyte should be between the minimum and maximum level marks.

PERIODIC MAINTENANCE AND MINOR REPAIR

ECA10610

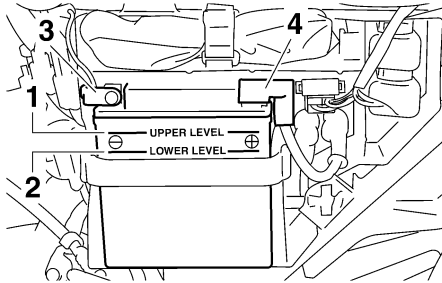

1. Maximum level mark
2. Minimum level mark
3. Negative battery lead
4. Positive battery lead (red)

4. If the electrolyte is at or below the minimum level mark, add distilled water to raise it to the maximum level mark.

EWA10770

WARNING

- **Electrolyte is poisonous and dangerous since it contains sulfuric acid, which causes severe burns. Avoid any contact with skin, eyes or clothing and always shield your eyes when**

working near batteries. In case of contact, administer the following **FIRST AID**.

- **EXTERNAL:** Flush with plenty of water.
- **INTERNAL:** Drink large quantities of water or milk and immediately call a physician.
- **EYES:** Flush with water for 15 minutes and seek prompt medical attention.
- **Batteries produce explosive hydrogen gas. Therefore, keep sparks, flames, cigarettes, etc., away from the battery and provide sufficient ventilation when charging it in an enclosed space.**
- **Take care not to spill electrolyte on the drive chain, as this may weaken it, shorten chain life and possibly result in an accident.**
- **KEEP THIS AND ALL BATTERIES OUT OF THE REACH OF CHILDREN.**

CAUTION:

Use only distilled water, as tap water contains minerals that are harmful to the battery.

5. Check and, if necessary, tighten the battery lead connections and correct the breather hose routing.

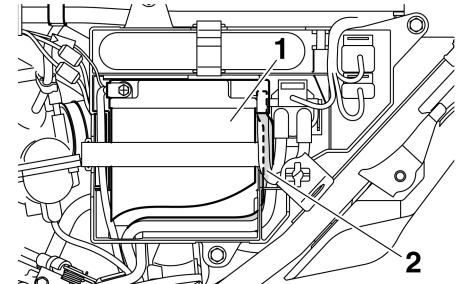

1. Battery
2. Battery breather hose

PERIODIC MAINTENANCE AND MINOR REPAIR

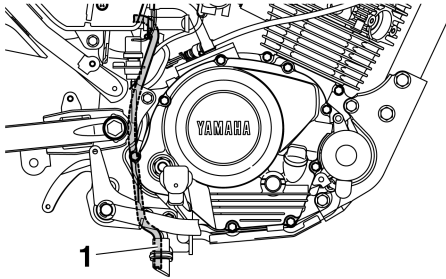

1. Battery breather hose
6. Install the panel.

To store the battery

1. If the vehicle will not be used for more than one month, remove the battery, fully charge it, and then place it in a cool, dry place.
2. If the battery will be stored for more than two months, check the specific gravity of the electrolyte at least once a month and fully charge the battery whenever necessary.
3. Fully charge the battery before installation.
4. After installation, make sure that the battery leads are properly connected to the battery terminals and

that the breather hose is properly routed, in good condition, and not obstructed.

ECA10600

CAUTION:

If the breather hose is positioned in such a way that the frame is exposed to electrolyte or gas expelled from the battery, the frame could suffer structural and external damages.

Replacing the fuse

EAU43211

The fuse is located behind panel B. (See page 6-6.) To access the fuse, remove the starter relay coupler.

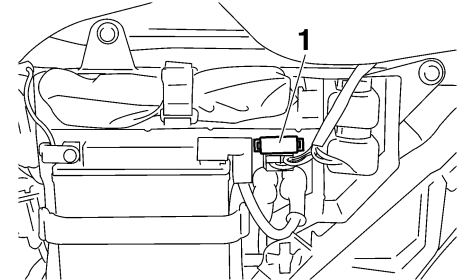

1. Starter relay coupler

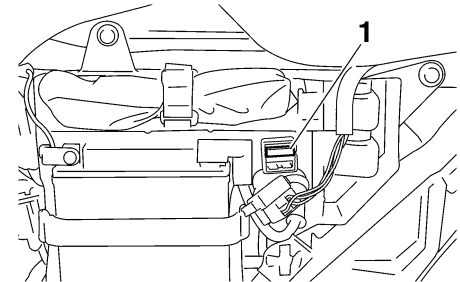

1. Fuse

PERIODIC MAINTENANCE AND MINOR REPAIR

The spare fuse is located on the rear of the starter relay holder.

To access the spare fuse, remove the starter relay (together with its holder) by pulling it out, then turn the starter relay over.

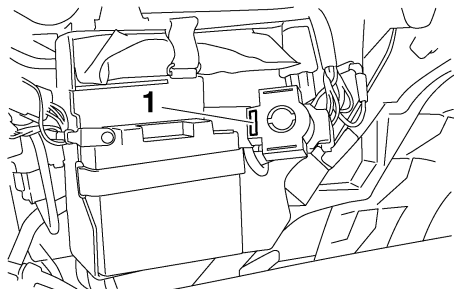

1. Spare fuse

If the fuse is blown, replace it as follows.

1. Turn the key to "OFF" and turn off all electrical circuits.
2. Remove the blown fuse, and then install a new fuse of the specified amperage.

Specified fuse:
15.0 A

ECA10640

CAUTION:

Do not use a fuse of a higher amperage rating than recommended to avoid causing extensive damage to the electrical system and possibly a fire.

3. Turn the key to "ON" and turn on the electrical circuits to check if the devices operate.
4. If the fuse immediately blows again, have a Yamaha dealer check the electrical system.

EAU43190

Replacing the headlight bulb

This model is equipped with a quartz bulb headlight. If the headlight bulb burns out, replace it as follows.

1. Remove the headlight unit by removing the screws.

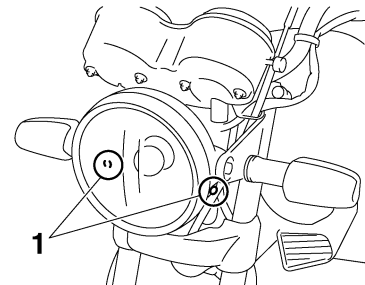

1. Screw

2. Remove the headlight bulb socket cover.

PERIODIC MAINTENANCE AND MINOR REPAIR

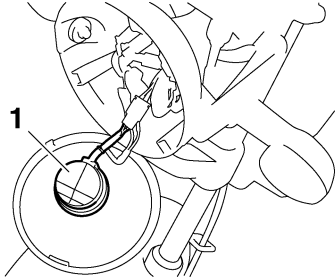

1. Headlight bulb socket cover

3. Remove the headlight bulb socket (together with the bulb) by turning it counterclockwise.

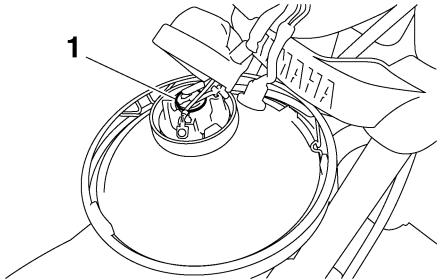

1. Headlight bulb socket

4. Remove the defective bulb by pushing it in and turning it counterclockwise.

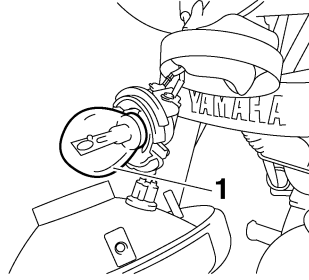

1. Headlight bulb

WARNING

Headlight bulbs get very hot. Therefore, keep flammable products away from a lit headlight bulb, and do not touch the bulb until it has cooled down.

5. Insert a new bulb into the socket, push it in, and then turn it clockwise until it stops.

CAUTION:

Do not touch the glass part of the headlight bulb to keep it free from oil, otherwise the transparency of the glass, the luminosity of the bulb, and the bulb life will be adversely af-

ected. Thoroughly clean off any dirt and fingerprints on the headlight bulb using a cloth moistened with alcohol or thinner.

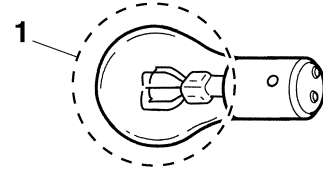

1. Do not touch the glass part of the bulb.
6. Install the socket (together with the bulb) by turning it clockwise.
7. Install the headlight bulb socket cover.
8. Install the headlight unit by installing the screws.
9. Have a Yamaha dealer adjust the headlight beam if necessary.

EWA10790

ECA10660

PERIODIC MAINTENANCE AND MINOR REPAIR

Replacing the tail/brake light bulb

EAU24131

1. Remove the tail/brake light lens by removing the screws.

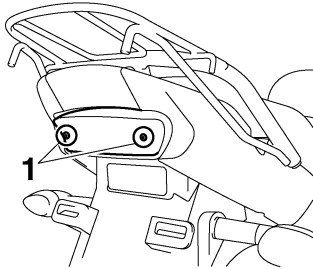

1. Screw

2. Remove the defective bulb by pushing it in and turning it counter-clockwise.

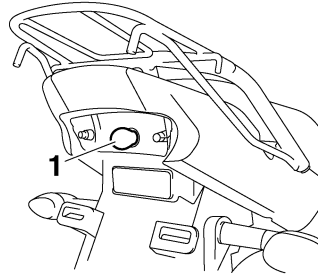

1. Tail/brake light bulb

3. Insert a new bulb into the socket, push it in, and then turn it clockwise until it stops.
4. Install the lens by installing the screws.

ECA10680

CAUTION: _____
Do not overtighten the screws, otherwise the lens may break.

Replacing a turn signal light bulb

EAU24202

1. Remove the turn signal light lens by removing the screw.

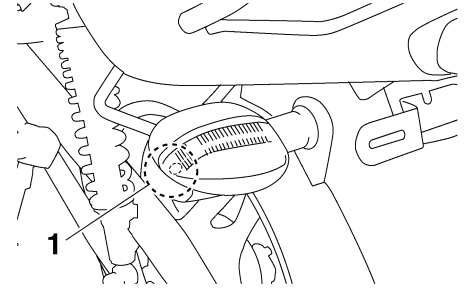

1. Screw

2. Remove the defective bulb by pushing it in and turning it counter-clockwise.
3. Insert a new bulb into the socket, push it in, and then turn it clockwise until it stops.
4. Install the lens by installing the screw.

ECA11190

CAUTION: _____
Do not overtighten the screw, otherwise the lens may break.

PERIODIC MAINTENANCE AND MINOR REPAIR

EAU37270

Replacing the auxiliary light bulb

If the auxiliary light bulb burns out, replace it as follows.

1. Remove the headlight unit by removing the screws.

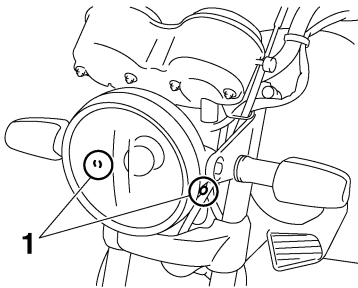

1. Screw

2. Remove the socket (together with the bulb) by pulling it out.

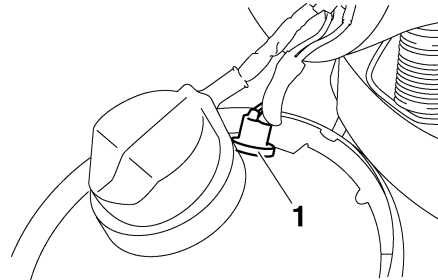

1. Auxiliary light bulb socket

3. Remove the defective bulb by pulling it out.

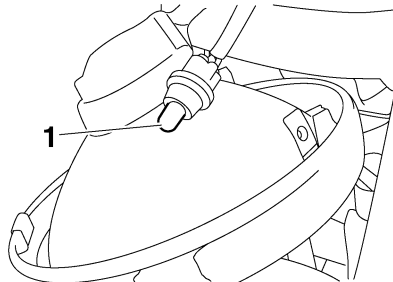

1. Auxiliary light bulb

4. Insert a new bulb into the socket.
5. Install the socket (together with the bulb) by pushing it in.
6. Install the headlight unit by installing the screws.

Front wheel

EAU24360

To remove the front wheel

EAU37041

EWA10820

⚠ WARNING

- It is advisable to have a Yamaha dealer service the wheel.
- Securely support the motorcycle so that there is no danger of it falling over.

1. Place the motorcycle on the centerstand.
2. Disconnect the speedometer cable from the front wheel.

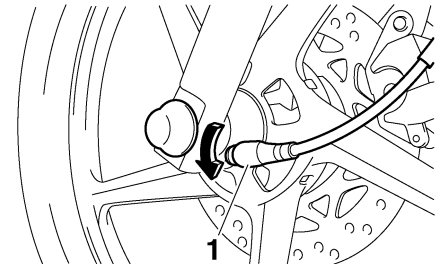

1. Speedometer cable

PERIODIC MAINTENANCE AND MINOR REPAIR

3. Remove the rubber caps from the ends of the wheel axle by pulling them off.

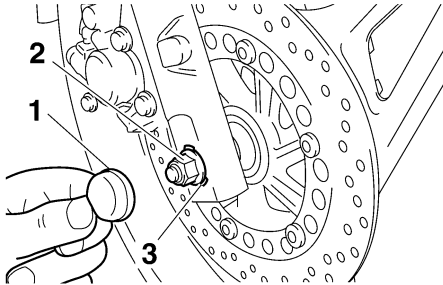

1. Rubber cap
2. Axle nut
3. Washer

4. Remove the axle nut and the washer.

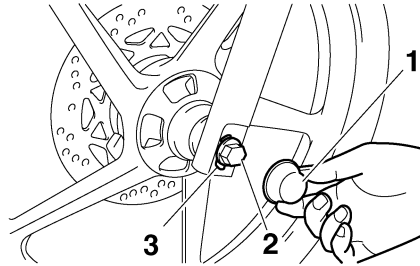

1. Rubber cap
2. Wheel axle
3. Washer

5. Pull the wheel axle out, and then remove the wheel.

ECA11070

CAUTION:

Do not apply the brake after the wheel has been removed together with the brake disc, otherwise the brake pads will be forced shut.

EAU37030

To install the front wheel

1. Install the speedometer gear unit into the wheel hub so that the projections mesh with the slots.

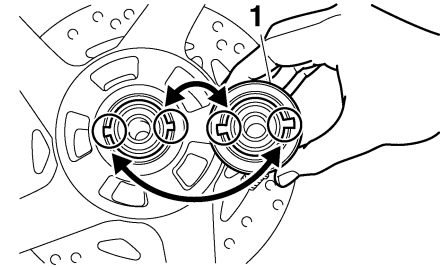

1. Speedometer gear unit

2. Lift the wheel up between the fork legs.

NOTE:

Make sure that there is enough space between the brake pads before inserting the brake disc and that the slot in the speedometer gear unit fits over the retainer on the fork leg.

PERIODIC MAINTENANCE AND MINOR REPAIR

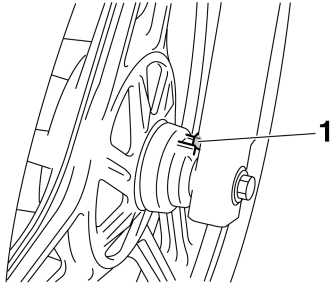

1. Speedometer gear unit retainer

3. Insert the wheel axle, making sure the washer on the left side is installed with the beveled side facing outward, and then install the axle nut.
4. Take the motorcycle off the center-stand so that the front wheel is on the ground.
5. Tighten the axle nut to the specified torque, and then install both rubber caps so that they fit over the washers.

Tightening torque:

Axle nut:

59 Nm (5.9 m·kgf, 43 ft·lbf)

6. While applying the front brake, push down hard on the handlebars several times to check if the front fork compresses and rebounds smoothly.
7. Connect the speedometer cable.

Rear wheel

EAU25080

To remove the rear wheel

EAU37180

EWA10820

⚠ WARNING

- It is advisable to have a Yamaha dealer service the wheel.
- Securely support the motorcycle so that there is no danger of it falling over.

1. Loosen the axle nut and the brake torque rod nut at the brake shoe plate.
2. Disconnect the brake torque rod from the brake shoe plate by removing the cotter pin, the nut, and the bolt.

PERIODIC MAINTENANCE AND MINOR REPAIR

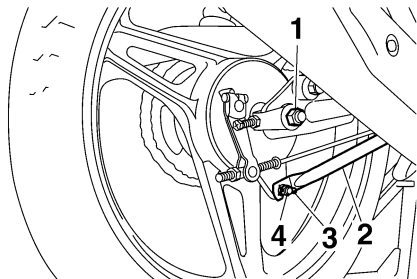

1. Axle nut
2. Brake torque rod
3. Brake torque rod cotter pin
4. Brake torque rod nut and bolt

3. Place the motorcycle on the centerstand.
4. Remove the brake pedal free play adjusting nut, and then disconnect the brake rod from the brake camshaft lever.

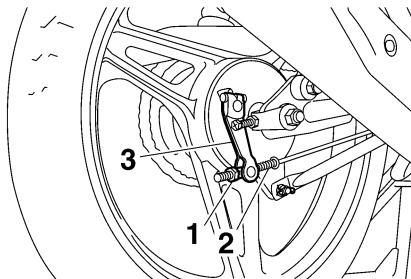

1. Brake pedal free play adjusting nut
2. Brake rod
3. Brake camshaft lever

5. Loosen the chain puller locknut and the drive chain slack adjusting bolt on both ends of the swingarm.

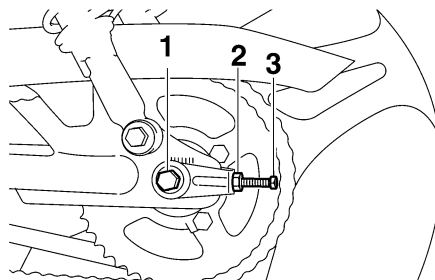

1. Wheel axle
2. Chain puller locknut
3. Drive chain slack adjusting bolt

6. Remove the axle nut, and then pull the wheel axle out.
7. Push the wheel forward, and then remove the drive chain from the rear sprocket.

NOTE: _____

The drive chain does not need to be disassembled in order to remove and install the wheel.

8. Remove the wheel.

EAU37192

To install the rear wheel

1. Install the wheel by inserting the wheel axle from the left-hand side.
2. Install the drive chain onto the rear sprocket.
3. Install the axle nut.
4. Install the brake rod onto the brake camshaft lever, and then install the brake pedal free play adjusting nut onto the brake rod.
5. Connect the brake torque rod to the brake shoe plate by installing the bolt and nut.
6. Adjust the drive chain slack. (See page 6-21.)

PERIODIC MAINTENANCE AND MINOR REPAIR

EAU25850

7. Take the motorcycle off the center-stand so that the rear wheel is on the ground.
8. Tighten the brake torque rod nut and axle nut to the specified torques.

Tightening torques:

- Brake torque rod nut:
19 Nm (1.9 m·kgf, 13 ft·lbf)
- Axle nut:
80 Nm (8.0 m·kgf, 58 ft·lbf)

9. Insert a new cotter pin.
10. Adjust the brake pedal free play. (See page 6-18.)

EWA10660

WARNING

After adjusting the brake pedal free play, check the operation of the brake light.

Troubleshooting

Although Yamaha motorcycles receive a thorough inspection before shipment from the factory, trouble may occur during operation. Any problem in the fuel, compression, or ignition systems, for example, can cause poor starting and loss of power.

The following troubleshooting chart represents a quick and easy procedure for checking these vital systems yourself. However, should your motorcycle require any repair, take it to a Yamaha dealer, whose skilled technicians have the necessary tools, experience, and know-how to service the motorcycle properly.

Use only genuine Yamaha replacement parts. Imitation parts may look like Yamaha parts, but they are often inferior, have a shorter service life and can lead to expensive repair bills.

PERIODIC MAINTENANCE AND MINOR REPAIR

EAU25962

Troubleshooting chart

EWA10840



Keep away open flames and do not smoke while checking or working on the fuel system.

1. Fuel

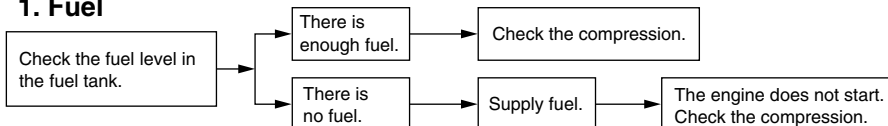

2. Compression

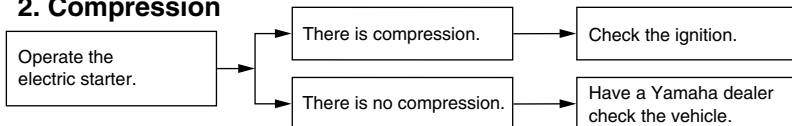

3. Ignition

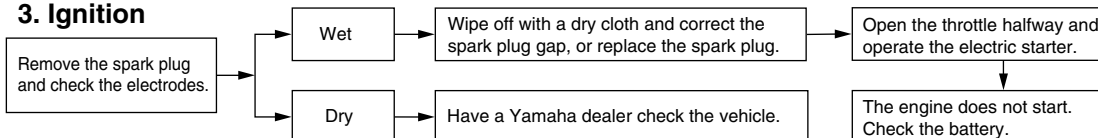

4. Battery

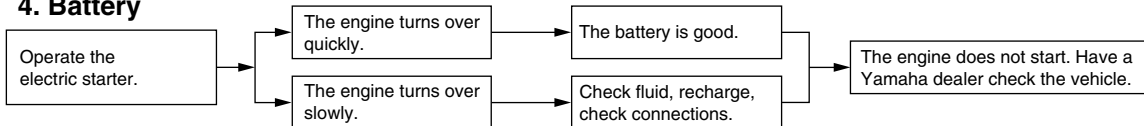

MOTORCYCLE CARE AND STORAGE

Matte color caution

EAU37833

ECA15192

CAUTION:

Some models are equipped with matte colored finished parts. Be sure to consult a Yamaha dealer for advice on what products to use before cleaning the vehicle. Using a brush, harsh chemical products or cleaning compounds when cleaning these parts will scratch or damage their surface. Wax also should not be applied to any matte colored finished parts.

Care

EAU26002

While the open design of a motorcycle reveals the attractiveness of the technology, it also makes it more vulnerable. Rust and corrosion can develop even if high-quality components are used. A rusty exhaust pipe may go unnoticed on a car, however, it detracts from the overall appearance of a motorcycle. Frequent and proper care does not only comply with the terms of the warranty, but it will also keep your motorcycle looking good, extend its life and optimize its performance.

Before cleaning

1. Cover the muffler outlet with a plastic bag after the engine has cooled down.
2. Make sure that all caps and covers as well as all electrical couplers and connectors, including the spark plug cap, are tightly installed.
3. Remove extremely stubborn dirt, like oil burnt onto the crankcase, with a degreasing agent and a brush, but never apply such prod-

ucts onto seals, gaskets, sprockets, the drive chain and wheel axles. Always rinse the dirt and degreaser off with water.

Cleaning

ECA10771

CAUTION:

- Avoid using strong acidic wheel cleaners, especially on spoked wheels. If such products are used on hard-to-remove dirt, do not leave the cleaner on the affected area any longer than instructed. Also, thoroughly rinse the area off with water, immediately dry it, and then apply a corrosion protection spray.
- Improper cleaning can damage plastic parts such as cowlings, panels, windshields, headlight lenses, meter lenses, etc. Use only a soft, clean cloth or sponge with mild detergent and water to clean plastic.
- Do not use any harsh chemical products on plastic parts. Be sure to avoid using cloths or sponges which have been in

MOTORCYCLE CARE AND STORAGE

contact with strong or abrasive cleaning products, solvent or thinner, fuel (gasoline), rust removers or inhibitors, brake fluid, antifreeze or electrolyte.

- Do not use high-pressure washers or steam-jet cleaners since they cause water seepage and deterioration in the following areas: seals (of wheel and swing-arm bearings, fork and brakes), electric components (couplers, connectors, instruments, switches and lights), breather hoses and vents.
- For motorcycles equipped with a windshield: Do not use strong cleaners or hard sponges as they will cause dulling or scratching. Some cleaning compounds for plastic may leave scratches on the windshield. Test the product on a small hidden part of the windshield to make sure that it does not leave any marks. If the windshield is

scratched, use a quality plastic polishing compound after washing.

After normal use

Remove dirt with warm water, a mild detergent, and a soft, clean sponge, and then rinse thoroughly with clean water. Use a toothbrush or bottlebrush for hard-to-reach areas. Stubborn dirt and insects will come off more easily if the area is covered with a wet cloth for a few minutes before cleaning.

After riding in the rain, near the sea or on salt-sprayed roads

Since sea salt or salt sprayed on roads during winter are extremely corrosive in combination with water, carry out the following steps after each ride in the rain, near the sea or on salt-sprayed roads.

NOTE: _____

Salt sprayed on roads in the winter may remain well into spring.

1. Clean the motorcycle with cold water and a mild detergent, after the engine has cooled down.

ECA10790

CAUTION: _____

Do not use warm water since it increases the corrosive action of the salt.

2. Apply a corrosion protection spray on all metal, including chrome- and nickel-plated, surfaces to prevent corrosion.

After cleaning

1. Dry the motorcycle with a chamois or an absorbing cloth.
2. Immediately dry the drive chain and lubricate it to prevent it from rusting.
3. Use a chrome polish to shine chrome, aluminum and stainless-steel parts, including the exhaust system. (Even the thermally induced discoloring of stainless-steel exhaust systems can be removed through polishing.)

MOTORCYCLE CARE AND STORAGE

ECA10800

4. To prevent corrosion, it is recommended to apply a corrosion protection spray on all metal, including chrome- and nickel-plated, surfaces.
5. Use spray oil as a universal cleaner to remove any remaining dirt.
6. Touch up minor paint damage caused by stones, etc.
7. Wax all painted surfaces.
8. Let the motorcycle dry completely before storing or covering it.

EWA11130

WARNING

- **Make sure that there is no oil or wax on the brakes or tires.**
 - **If necessary, clean the brake discs and brake linings with a regular brake disc cleaner or acetone, and wash the tires with warm water and a mild detergent. Before riding at higher speeds, test the motorcycle's braking performance and cornering behavior.**
-

CAUTION:

- **Apply spray oil and wax sparingly and make sure to wipe off any excess.**
 - **Never apply oil or wax to any rubber and plastic parts, but treat them with a suitable care product.**
 - **Avoid using abrasive polishing compounds as they will wear away the paint.**
-

NOTE:

Consult a Yamaha dealer for advice on what products to use.

ECA37220

Storage

Short-term

Always store your motorcycle in a cool, dry place and, if necessary, protect it against dust with a porous cover.

ECA10810

CAUTION:

- **Storing the motorcycle in a poorly ventilated room or covering it with a tarp, while it is still wet, will allow water and humidity to seep in and cause rust.**
 - **To prevent corrosion, avoid damp cellars, stables (because of the presence of ammonia) and areas where strong chemicals are stored.**
-

Long-term

Before storing your motorcycle for several months:

1. Follow all the instructions in the "Care" section of this chapter.
2. Turn the fuel cock lever to "OFF" or "●".

MOTORCYCLE CARE AND STORAGE

3. Drain the carburetor float chamber by loosening the drain bolt; this will prevent fuel deposits from building up. Pour the drained fuel into the fuel tank.
4. Fill up the fuel tank and add fuel stabilizer (if available) to prevent the fuel tank from rusting and the fuel from deteriorating.
5. Perform the following steps to protect the cylinder, piston rings, etc. from corrosion.
 - a. Remove the spark plug cap and spark plug.
 - b. Pour a teaspoonful of engine oil into the spark plug bore.
 - c. Install the spark plug cap onto the spark plug, and then place the spark plug on the cylinder head so that the electrodes are grounded. (This will limit sparking during the next step.)
 - d. Turn the engine over several times with the starter. (This will coat the cylinder wall with oil.)
 - e. Remove the spark plug cap from the spark plug, and then install the spark plug and the spark plug cap.

EWA10950

WARNING

To prevent damage or injury from sparking, make sure to ground the spark plug electrodes while turning the engine over.

6. Lubricate all control cables and the pivoting points of all levers and pedals as well as of the side-stand/centerstand.
7. Check and, if necessary, correct the tire air pressure, and then lift the motorcycle so that both of its wheels are off the ground. Alternatively, turn the wheels a little every month in order to prevent the tires from becoming degraded in one spot.
8. Cover the muffler outlet with a plastic bag to prevent moisture from entering it.
9. Remove the battery and fully charge it. Store it in a cool, dry place and charge it once a month. Do not store the battery in an excessively cold or warm place [less than 0 °C (30 °F) or more than 30

°C (90 °F)]. For more information on storing the battery, see page 6-27.

NOTE:

Make any necessary repairs before storing the motorcycle.

SPECIFICATIONS

Dimensions:

Overall length:
1980 mm (78.0 in)
Overall width:
745 mm (29.3 in)
Overall height:
1080 mm (42.5 in)
Seat height:
780 mm (30.7 in)
Wheelbase:
1290 mm (50.8 in)
Ground clearance:
175 mm (6.89 in)
Minimum turning radius:
1750 mm (68.9 in)

Weight:

With oil and fuel:
122.0 kg (269 lb)

Engine:

Engine type:
Air cooled 4-stroke, SOHC
Cylinder arrangement:
Forward-inclined single cylinder
Displacement:
123.7 cm³
Bore × stroke:
54.0 × 54.0 mm (2.13 × 2.13 in)
Compression ratio:
10.00 :1
Starting system:
Electric starter and kickstarter
Lubrication system:
Wet sump

Engine oil:

Type:
SAE10W30, SAE10W40, SAE15W40,
SAE20W40 or SAE20W50

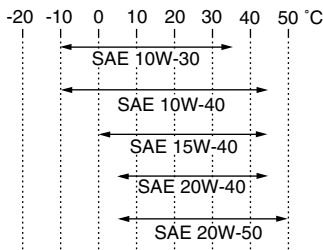

Recommended engine oil grade:
API service SG type or higher, JASO
standard MA
Engine oil quantity:
Periodic oil change:
1.00 L (1.06 US qt) (0.88 Imp.qt)

Air filter:

Air filter element:
Dry element

Fuel:

Recommended fuel:
Regular unleaded gasoline only
Fuel tank capacity:
12.0 L (3.17 US gal) (2.64 Imp.gal)
Fuel reserve amount:
1.7 L (0.45 US gal) (0.37 Imp.gal)

Carburetor:

Manufacturer:
MIKUNI
Type × quantity:
VM22SH x 1

Spark plug (s):

Manufacturer/model:
NGK/CR6HSA
Spark plug gap:
0.6–0.7 mm (0.024–0.028 in)

Clutch:

Clutch type:
Wet, multiple-disc

Transmission:

Primary reduction system:
Helical gear
Primary reduction ratio:
68/20 (3.400)
Secondary reduction system:
Chain drive
Secondary reduction ratio:
45/14 (3.214)
Transmission type:
Constant mesh 5-speed
Operation:
Left foot operation
Gear ratio:
1st:
37/14 (2.643)
2nd:
32/18 (1.778)
3rd:
25/19 (1.316)

4th:
23/22 (1.045)

5th:
21/24 (0.875)

Chassis:

Frame type:
Diamond

Caster angle:
26.33 °

Trail:
90.0 mm (3.54 in)

Front tire:

Type:
Tubeless

Size:
2.75-18 42P

Manufacturer/model:
CHENG SHIN/C-910

Rear tire:

Type:
Tubeless

Size:
90/90-18 57P

Manufacturer/model:
CHENG SHIN/C-905

Loading:

Maximum load:
198 kg (437 lb)
(Total weight of rider, passenger, cargo and accessories)

Tire air pressure (measured on cold tires):

Loading condition:
0–90 kg (0–198 lb)

Front:
175 kPa (25 psi) (1.75 kgf/cm²)

Rear:
200 kPa (29 psi) (2.00 kgf/cm²)

Loading condition:
90–198 kg (198–437 lb)

Front:
175 kPa (25 psi) (1.75 kgf/cm²)

Rear:
280 kPa (41 psi) (2.80 kgf/cm²)

Front wheel:

Wheel type:
Cast wheel

Rim size:
J18 x MT1.85

Rear wheel:

Wheel type:
Cast wheel

Rim size:
J18 x MT1.85

Front brake:

Type:
Single disc brake

Operation:
Right hand operation

Recommended fluid:
DOT 3 or 4

Rear brake:

Type:
Drum brake

Operation:
Right foot operation

Front suspension:

Type:
Telescopic fork
Spring/shock absorber type:
Coil spring/oil damper
Wheel travel:
120.0 mm (4.72 in)

Rear suspension:

Type:
Swingarm
Spring/shock absorber type:
Coil spring/oil damper
Wheel travel:
105.0 mm (4.13 in)

Electrical system:

Ignition system:
DC. CDI
Charging system:
AC magneto

Battery:

Model:
CB5L-B
Voltage, capacity:
12 V, 5.0 Ah

Headlight:

Bulb type:
Incandescence

Bulb voltage, wattage × quantity:

Headlight:
12 V, 35 W/35.0 W × 1
Tail/brake light:
12 V, 5.0 W/21.0 W × 1
Front turn signal light:
12 V, 10.0 W × 2

SPECIFICATIONS

Rear turn signal light:

12 V, 10.0 W \times 2

Auxiliary light:

12 V, 5.0 W \times 1

Meter lighting:

12 V, 1.7 W \times 4

Neutral indicator light:

14 V, 3.0 W \times 1

High beam indicator light:

14 V, 3.0 W \times 1

Turn signal indicator light:

14 V, 3.0 W \times 2

Fuse:

Fuse:

15.0 A

EAU26351

Identification numbers

Record the key identification number, vehicle identification number and model label information in the spaces provided below for assistance when ordering spare parts from a Yamaha dealer or for reference in case the vehicle is stolen.

KEY IDENTIFICATION NUMBER:

VEHICLE IDENTIFICATION NUMBER:

MODEL LABEL INFORMATION:

Key identification number

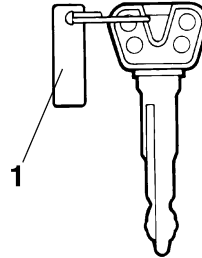

1. Key identification number

The key identification number is stamped into the key tag. Record this number in the space provided and use it for reference when ordering a new key.

EAU26381

Vehicle identification number

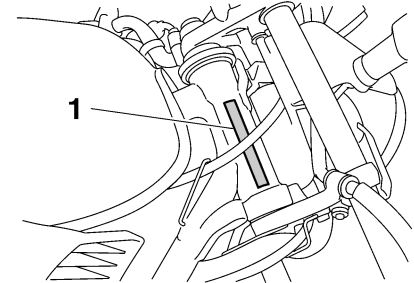

1. Vehicle identification number

The vehicle identification number is stamped into the steering head pipe. Record this number in the space provided.

NOTE: _____

The vehicle identification number is used to identify your motorcycle and may be used to register your motorcycle with the licensing authority in your area.

CONSUMER INFORMATION

EAU36980

Model label

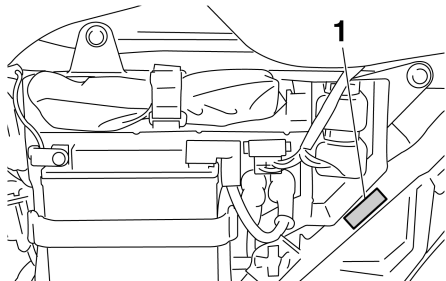

1. Model label

The model label is affixed to the frame behind panel B. (See page 6-6.) Record the information on this label in the space provided. This information will be needed when ordering spare parts from a Yamaha dealer.

- A**
- Air filter element, cleaning 6-10
 - Auxiliary light bulb, replacing 6-33
- B**
- Battery 6-27
 - Brake and clutch levers,
 - checking and lubricating 6-24
 - Brake and shift pedals,
 - checking and lubricating 6-24
 - Brake fluid, changing 6-21
 - Brake fluid level, checking 6-20
 - Brake lever 3-5
 - Brake pads and shoes, checking 6-19
 - Brake pedal 3-5
 - Brake pedal free play, adjusting 6-18
- C**
- Cables, checking and lubricating 6-23
 - Carburetor, adjusting 6-12
 - Care 7-1
 - Carrier 3-10
 - Catalytic converter 3-7
 - Centerstand and sidestand,
 - checking and lubricating 6-25
 - Clutch lever 3-4
 - Clutch lever free play, adjusting 6-16
- D**
- Dimmer switch 3-4
 - Drive chain, cleaning and lubricating 6-22
 - Drive chain slack 6-21
- E**
- Engine break-in 5-3
 - Engine idling speed 6-12
 - Engine oil 6-9
 - Engine, starting a warm 5-2
- F**
- Front brake lever free play, checking6-17
 - Front fork, checking6-26
 - Fuel3-6
 - Fuel cock3-7
 - Fuel consumption, tips for reducing5-3
 - Fuel gauge3-3
 - Fuel tank cap3-5
 - Fuse, replacing6-29
- H**
- Handlebar switches3-3
 - Headlight bulb, replacing6-30
 - High beam indicator light3-2
 - Horn switch3-4
- I**
- Identification numbers9-1
 - Ignition circuit cut-off system3-11
 - Indicator lights3-2
- K**
- Key identification number9-1
 - Kickstarter3-9
- L**
- Luggage strap holders3-10
- M**
- Main switch/steering lock3-1
 - Matte color, caution7-1
 - Model label9-2
- N**
- Neutral indicator light3-2
- P**
- Panels, removing and installing6-6
 - Parking5-4
 - Part locations2-1
- Periodic maintenance and
lubrication chart 6-2
- Pre-operation check list 4-2
- R**
- Rear brake light switch, adjusting 6-18
- S**
- Safety information 1-1
 - Shifting 5-2
 - Shift pedal 3-4
 - Shock absorber assemblies, adjusting ... 3-9
 - Sidestand 3-10
 - Spark plug, checking 6-7
 - Specifications 8-1
 - Speedometer unit 3-2
 - Starter (choke) lever 3-8
 - Starting a cold engine 5-1
 - Start switch 3-4
 - Steering, checking 6-26
 - Storage 7-3
 - Swingarm pivots, lubricating 6-25
- T**
- Tachometer 3-3
 - Tail/brake light bulb, replacing 6-32
 - Throttle cable free play, adjusting 6-13
 - Throttle grip and cable,
 - checking and lubricating 6-23
 - Tires 6-14
 - Tool kit 6-1
 - Troubleshooting 6-37
 - Troubleshooting chart 6-38
 - Turn signal indicator lights 3-2
 - Turn signal light bulb, replacing 6-32
 - Turn signal switch 3-4

INDEX

V

- Valve clearance6-14
- Vehicle identification number 9-1

W

- Wheel bearings, checking.....6-27
- Wheel (front) 6-33
- Wheel (rear) 6-35
- Wheels 6-16



PRINTED IN CHINA
2007.01-0.3×1 CR
(E)