





OWNER'S MANUAL

XT1200ZE
Super Ténéré ABS
MOTORCYCLE

 **Read this manual carefully before operating this vehicle.**

XT1200ZE

BP9-28199-E1

 **Read this manual carefully before operating this vehicle. This manual should stay with this vehicle if it is sold.**

Declaration of Conformity:

Hereby, YAMAHA MOTOR ELECTRONICS Co., Ltd declares that the radio equipment type, IMMOBILIZER, 2BS-00 is in compliance with Directive 2014/53/EU. The full text of the EU declaration of conformity is available at the following internet address:

https://global.yamaha-motor.com/eu_doc/

Frequency band: 134.2 kHz

The maximum radio frequency power: 49.0 [dB μ V/m]

Manufacturer:

YAMAHA MOTOR ELECTRONICS Co., Ltd

1450-6 Mori, Mori-machi, Shuchi-Gun, Shizuoka, 437-0292 Japan

Importer:

YAMAHA MOTOR EUROPE N.V.

Koolhovenlaan 101, 1119 NC Schiphol-Rijk, 1117 ZN, Schiphol, the Netherlands

Welcome to the Yamaha world of motorcycling!

As the owner of the XT1200ZE, you are benefiting from Yamaha's vast experience and newest technology regarding the design and manufacture of high-quality products, which have earned Yamaha a reputation for dependability.

Please take the time to read this manual thoroughly, so as to enjoy all advantages of your XT1200ZE. The Owner's Manual does not only instruct you in how to operate, inspect and maintain your motorcycle, but also in how to safeguard yourself and others from trouble and injury.

In addition, the many tips given in this manual will help keep your motorcycle in the best possible condition. If you have any further questions, do not hesitate to contact your Yamaha dealer.

The Yamaha team wishes you many safe and pleasant rides. So, remember to put safety first!

Yamaha continually seeks advancements in product design and quality. Therefore, while this manual contains the most current product information available at the time of printing, there may be minor discrepancies between your motorcycle and this manual. If there is any question concerning this manual, please consult a Yamaha dealer.







Please read this manual carefully and completely before operating this motorcycle.

Important manual information

EAU63350

Particularly important information is distinguished in this manual by the following notations:

	This is the safety alert symbol. It is used to alert you to potential personal injury hazards. Obey all safety messages that follow this symbol to avoid possible injury or death.
	A WARNING indicates a hazardous situation which, if not avoided, could result in death or serious injury.
	A NOTICE indicates special precautions that must be taken to avoid damage to the vehicle or other property.
	A TIP provides key information to make procedures easier or clearer.

*Product and specifications are subject to change without notice.

EAU10201

**XT1200ZE
OWNER'S MANUAL
©2019 by Yamaha Motor Co., Ltd.
1st edition, August 2018
All rights reserved.
Any reprinting or unauthorized use
without the written permission of
Yamaha Motor Co., Ltd.
is expressly prohibited.
Printed in Japan.**

Table of contents

Safety information	1-1	Engine break-in.....	5-5
Description	2-1	Parking.....	5-6
Left view	2-1	Periodic maintenance and adjustment	6-1
Right view.....	2-2	Tool kit	6-2
Controls and instruments.....	2-3	Periodic maintenance charts	6-3
Instrument and control functions	3-1	Periodic maintenance chart for the emission control system.....	6-3
Immobilizer system	3-1	General maintenance and lubrication chart.....	6-4
Main switch/steering lock	3-2	Removing and installing cowlings	6-7
Indicator lights and warning lights	3-3	Checking the spark plugs	6-9
Cruise control system	3-6	Canister.....	6-10
Multi-function meter unit	3-9	Engine oil	6-10
D-mode (drive mode)	3-21	Why Yamalube.....	6-13
Handlebar switches.....	3-22	Final gear oil.....	6-14
Clutch lever	3-23	Coolant	6-16
Shift pedal	3-24	Air filter element	6-17
Brake lever	3-24	Checking the engine idling speed.....	6-18
Brake pedal	3-25	Checking the throttle grip free play	6-18
ABS	3-26	Valve clearance.....	6-19
Traction control system.....	3-27	Tires	6-19
Fuel tank cap.....	3-29	Spoke wheels	6-22
Fuel.....	3-29	Clutch lever	6-22
Fuel tank overflow hose	3-31	Checking the brake lever free play	6-23
Catalytic converter	3-31	Brake light switches.....	6-23
Rider seat	3-32	Checking the front and rear brake pads.....	6-24
Adjusting the rider seat height	3-33	Checking the brake fluid level.....	6-25
Windshield.....	3-34	Changing the brake and clutch fluids	6-26
Adjusting the front and rear suspension.....	3-35	Checking and lubricating the throttle grip and cable	6-26
Carriers.....	3-40	Checking and lubricating the brake and shift pedals.....	6-27
Luggage strap holders	3-41	Checking and lubricating the brake and clutch levers	6-27
Auxiliary DC jack	3-41	Checking and lubricating the centerstand and sidestand.....	6-28
Sidestand	3-42	Lubricating the swingarm pivots... ..	6-28
Ignition circuit cut-off system.....	3-43	Checking the front fork	6-29
For your safety – pre-operation checks	4-1		
Operation and important riding points	5-1		
Starting the engine	5-2		
Shifting	5-3		
Tips for reducing fuel consumption	5-4		

Table of contents

Checking the steering.....	6-29
Checking the wheel bearings	6-30
Battery	6-30
Replacing the fuses	6-32
Replacing a headlight bulb.....	6-33
Replacing an auxiliary light bulb...	6-35
Turn signal light and brake/tail light	6-37
Replacing a license plate light bulb	6-38
Troubleshooting.....	6-39
Troubleshooting charts.....	6-40
Motorcycle care and storage.....	7-1
Matte color caution	7-1
Care	7-1
Storage.....	7-4
Specifications.....	8-1
Consumer information.....	9-1
Identification numbers.....	9-1
Diagnostic connector	9-2
Vehicle data recording.....	9-3
Index.....	10-1

EAU1031C

See page 4-1 for a list of pre-operation checks.

Be a Responsible Owner

As the vehicle's owner, you are responsible for the safe and proper operation of your motorcycle.

Motorcycles are single-track vehicles. Their safe use and operation are dependent upon the use of proper riding techniques as well as the expertise of the operator. Every operator should know the following requirements before riding this motorcycle.

He or she should:

- Obtain thorough instructions from a competent source on all aspects of motorcycle operation.
- Observe the warnings and maintenance requirements in this Owner's Manual.
- Obtain qualified training in safe and proper riding techniques.
- Obtain professional technical service as indicated in this Owner's Manual and/or when made necessary by mechanical conditions.
- Never operate a motorcycle without proper training or instruction. Take a training course. Beginners should receive training from a certified instructor. Contact an authorized motorcycle dealer to find out about the training courses nearest you.

Safe Riding

Perform the pre-operation checks each time you use the vehicle to make sure it is in safe operating condition. Failure to inspect or maintain the vehicle properly increases the possibility of an accident or equipment damage.

- This motorcycle is designed to carry the operator and a passenger.
- The failure of motorists to detect and recognize motorcycles in traffic is the predominating cause of automobile/motorcycle accidents. Many accidents have been caused by an automobile driver who did not see the motorcycle. Making yourself conspicuous appears to be very effective in reducing the chance of this type of accident.

Therefore:

- Wear a brightly colored jacket.
- Use extra caution when you are approaching and passing through intersections, since intersections are the most likely places for motorcycle accidents to occur.
- Ride where other motorists can see you. Avoid riding in another motorist's blind spot.
- Never maintain a motorcycle without proper knowledge. Contact an authorized motorcycle dealer to inform you on basic motorcycle maintenance. Certain maintenance can only be carried out by certified staff.

Safety information

1

- Many accidents involve inexperienced operators. In fact, many operators who have been involved in accidents do not even have a current motorcycle license.
- Make sure that you are qualified and that you only lend your motorcycle to other qualified operators.
- Know your skills and limits. Staying within your limits may help you to avoid an accident.
- We recommend that you practice riding your motorcycle where there is no traffic until you have become thoroughly familiar with the motorcycle and all of its controls.
- Many accidents have been caused by error of the motorcycle operator. A typical error made by the operator is veering wide on a turn due to excessive speed or undercornering (insufficient lean angle for the speed).
 - Always obey the speed limit and never travel faster than warranted by road and traffic conditions.
 - Always signal before turning or changing lanes. Make sure that other motorists can see you.
- The posture of the operator and passenger is important for proper control.
 - The operator should keep both hands on the handlebar and both feet on the operator footrests during operation to maintain control of the motorcycle.
 - The passenger should always hold onto the operator, the seat strap or grab bar, if equipped, with both hands and keep both feet on the passenger footrests. Never carry a passenger unless he or she can firmly place both feet on the passenger footrests.
- Never ride under the influence of alcohol or other drugs.

Protective Apparel

The majority of fatalities from motorcycle accidents are the result of head injuries. The use of a safety helmet is the single most critical factor in the prevention or reduction of head injuries.

- Always wear an approved helmet.
- Wear a face shield or goggles. Wind in your unprotected eyes could contribute to an impairment of vision that could delay seeing a hazard.
- The use of a jacket, heavy boots, trousers, gloves, etc., is effective in preventing or reducing abrasions or lacerations.
- Never wear loose-fitting clothes, otherwise they could catch on the control levers, footrests, or wheels and cause injury or an accident.
- Always wear protective clothing that covers your legs, ankles, and feet. The engine or exhaust system become very hot during or after operation and can cause burns.
- A passenger should also observe the above precautions.

Avoid Carbon Monoxide Poisoning

All engine exhaust contains carbon monoxide, a deadly gas. Breathing carbon monoxide can cause headaches, dizziness, drowsiness, nausea, confusion, and eventually death.

Carbon Monoxide is a colorless, odorless, tasteless gas which may be present even if you do not see or smell any engine exhaust. Deadly levels of carbon monoxide can collect rapidly and you can quickly be overcome and unable to save yourself. Also, deadly levels of carbon monoxide can linger for hours or days in enclosed or poorly ventilated areas. If you experience any symptoms of carbon monoxide poisoning, leave the area immediately, get fresh air, and SEEK MEDICAL TREATMENT.

- Do not run engine indoors. Even if you try to ventilate engine exhaust with fans or open windows and doors, carbon monoxide can rapidly reach dangerous levels.
- Do not run engine in poorly ventilated or partially enclosed areas such as barns, garages, or carports.
- Do not run engine outdoors where engine exhaust can be drawn into a building through openings such as windows and doors.

Loading

Adding accessories or cargo to your motorcycle can adversely affect stability and handling if the weight distribution of the motorcycle is changed. To avoid the possibility of an accident, use extreme caution when adding cargo or accessories to your motorcycle. Use

extra care when riding a motorcycle that has added cargo or accessories. Here, along with the information about accessories below, are some general guidelines to follow if loading cargo to your motorcycle:

The total weight of the operator, passenger, accessories and cargo must not exceed the maximum load limit.

Operation of an overloaded vehicle could cause an accident.

<p>Maximum load: 204 kg (450 lb)</p>

When loading within this weight limit, keep the following in mind:

- Cargo and accessory weight should be kept as low and close to the motorcycle as possible. Securely pack your heaviest items as close to the center of the vehicle as possible and make sure to distribute the weight as evenly as possible on both sides of the motorcycle to minimize imbalance or instability.
- Shifting weights can create a sudden imbalance. Make sure that accessories and cargo are securely attached to the motorcycle before riding. Check accessory mounts and cargo restraints frequently.
- Properly adjust the suspension for your load (suspension-adjustable models only), and check the condition and pressure of your tires.
- Never attach any large or heavy items to the handlebar, front fork, or front fender. These items, including such cargo as

Safety information

sleeping bags, duffel bags, or tents, can create unstable handling or a slow steering response.

- **This vehicle is not designed to pull a trailer or to be attached to a sidecar.**

Genuine Yamaha Accessories

Choosing accessories for your vehicle is an important decision. Genuine Yamaha accessories, which are available only from a Yamaha dealer, have been designed, tested, and approved by Yamaha for use on your vehicle.

Many companies with no connection to Yamaha manufacture parts and accessories or offer other modifications for Yamaha vehicles. Yamaha is not in a position to test the products that these aftermarket companies produce. Therefore, Yamaha can neither endorse nor recommend the use of accessories not sold by Yamaha or modifications not specifically recommended by Yamaha, even if sold and installed by a Yamaha dealer.

Aftermarket Parts, Accessories, and Modifications

While you may find aftermarket products similar in design and quality to genuine Yamaha accessories, recognize that some aftermarket accessories or modifications are not suitable because of potential safety hazards to you or others. Installing aftermarket products or having other modifications performed to your vehicle that change any of the vehicle's design or operation characteristics can put you and others

at greater risk of serious injury or death. You are responsible for injuries related to changes in the vehicle.

Keep the following guidelines in mind, as well as those provided under "Loading" when mounting accessories.

- Never install accessories or carry cargo that would impair the performance of your motorcycle. Carefully inspect the accessory before using it to make sure that it does not in any way reduce ground clearance or cornering clearance, limit suspension travel, steering travel or control operation, or obscure lights or reflectors.
- Accessories fitted to the handlebar or the front fork area can create instability due to improper weight distribution or aerodynamic changes. If accessories are added to the handlebar or front fork area, they must be as lightweight as possible and should be kept to a minimum.
- Bulky or large accessories may seriously affect the stability of the motorcycle due to aerodynamic effects. Wind may attempt to lift the motorcycle, or the motorcycle may become unstable in cross winds. These accessories may also cause instability when passing or being passed by large vehicles.
- Certain accessories can displace the operator from his or her normal riding position. This improper position limits the freedom of movement of the

operator and may limit control ability, therefore, such accessories are not recommended.

- Use caution when adding electrical accessories. If electrical accessories exceed the capacity of the motorcycle's electrical system, an electric failure could result, which could cause a dangerous loss of lights or engine power.

Aftermarket Tires and Rims

The tires and rims that came with your motorcycle were designed to match the performance capabilities and to provide the best combination of handling, braking, and comfort. Other tires, rims, sizes, and combinations may not be appropriate. Refer to page 6-19 for tire specifications and more information on replacing your tires.

Transporting the Motorcycle

Be sure to observe following instructions before transporting the motorcycle in another vehicle.

- Remove all loose items from the motorcycle.
- Check that the fuel cock (if equipped) is in the "OFF" position and that there are no fuel leaks.
- Point the front wheel straight ahead on the trailer or in the truck bed, and choke it in a rail to prevent movement.
- Shift the transmission in gear (for models with a manual transmission).
- Secure the motorcycle with tie-downs or suitable straps that are attached to solid parts of the mo-

torcycle, such as the frame or upper front fork triple clamp (and not, for example, to rubber-mounted handlebars or turn signals, or parts that could break). Choose the location for the straps carefully so the straps will not rub against painted surfaces during transport.

- The suspension should be compressed somewhat by the tie-downs, if possible, so that the motorcycle will not bounce excessively during transport.

Description

EAU63371

Left view

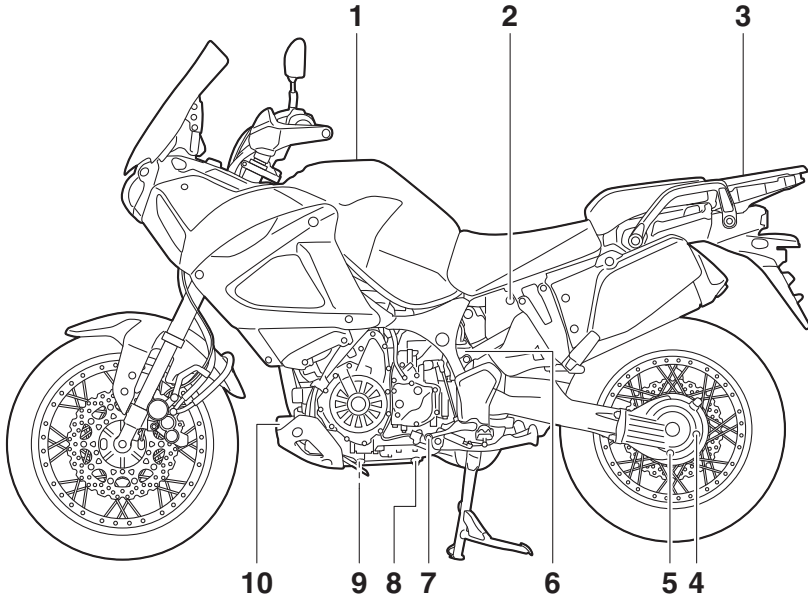

1. Fuel tank cap (page 3-29)
2. Seat lock (page 3-32)
3. Carrier (page 3-40)
4. Final gear oil filler bolt (page 6-14)
5. Final gear oil drain bolt (page 6-14)
6. Coolant reservoir (page 6-16)
7. Shift pedal (page 3-24)
8. Engine oil drain bolt (oil tank) (page 6-10)
9. Engine oil drain bolt (crankcase) (page 6-10)
10. Engine oil filter cartridge (page 6-10)

Right view

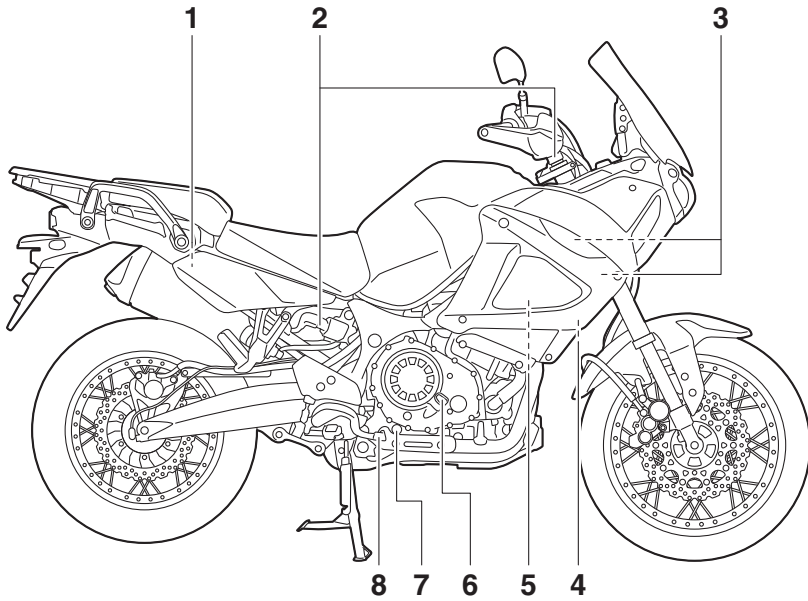

1. Rear brake fluid reservoir (page 6-25)
2. Electronically adjustable suspension system (page 3-35)
3. Fuses (page 6-32)
4. Tool kit (page 6-2)
5. Battery (page 6-30)
6. Engine oil filler cap (page 6-10)
7. Engine oil level check window (page 6-10)
8. Brake pedal (page 3-25)

Description

EAU63401

Controls and instruments

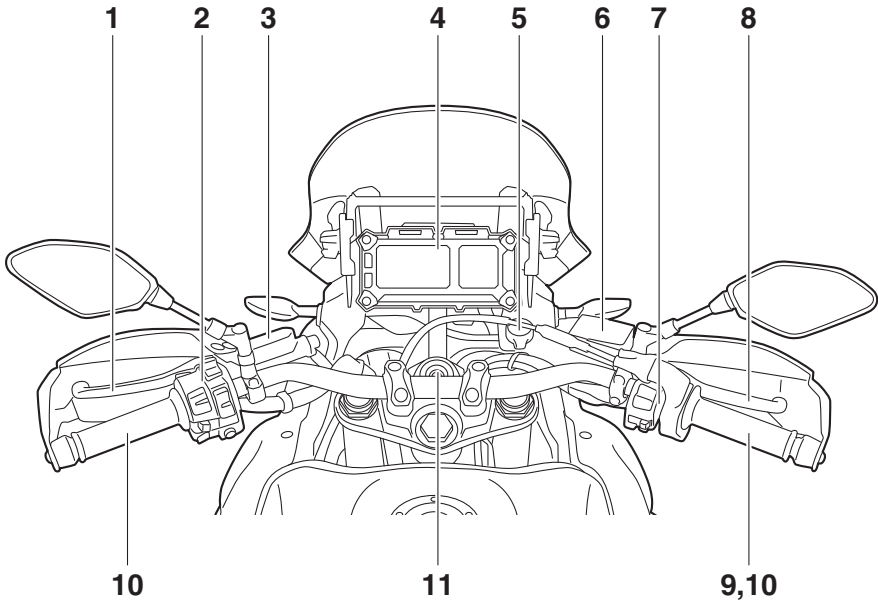

1. Clutch lever (page 3-23)
2. Left handlebar switches (page 3-22)
3. Clutch fluid reservoir (page 6-25)
4. Multi-function meter unit (page 3-9)
5. Auxiliary DC jack (page 3-41)
6. Front brake fluid reservoir (page 6-25)
7. Right handlebar switches (page 3-22)
8. Brake lever (page 3-24)
9. Throttle grip (page 6-18)
10. Grip warmer (page 3-11)
11. Main switch/steering lock (page 3-2)

Immobilizer system

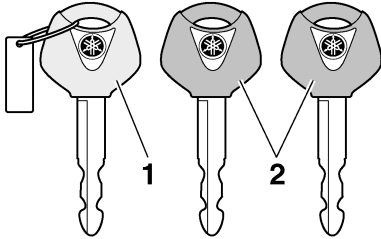

1. Code re-registering key (red bow)
2. Standard keys (black bow)

This vehicle is equipped with an immobilizer system to help prevent theft by re-registering codes in the standard keys. This system consists of the following:

- a code re-registering key
- two standard keys
- a transponder (in each key)
- an immobilizer unit (on the vehicle)
- an ECU (on the vehicle)
- a system indicator light (page 3-5)

About the keys

The key with the red bow is used to register codes in each standard key. Store the code re-registering key in a safe place. When necessary, take the vehicle along with all three keys to a Yamaha dealer to have them re-registered.

Do not use the key with the red bow for driving. It should only be used for re-registering the standard keys. Always use a standard key for driving.

TIP

- Keep the standard keys as well as keys of other immobilizer systems away from the code re-registering key.
- Keep other immobilizer system keys away from the main switch as they may cause signal interference.

ECA11823

NOTICE

DO NOT LOSE THE CODE RE-REGISTERING KEY! CONTACT YOUR DEALER IMMEDIATELY IF IT IS LOST! If the code re-registering key is lost, the existing standard keys can still be used to start the vehicle. However, registering a new standard key is impossible. If all keys have been lost or damaged, the entire immobilizer system must be replaced. Therefore, handle the keys carefully.

- Do not submerge in water.
- Do not expose to high temperatures.
- Do not place near magnets.
- Do not place near items that transmit electrical signals.
- Do not handle roughly.
- Do not grind or alter.
- Do not disassemble.
- Do not put two keys of any immobilizer system on the same key ring.

Instrument and control functions

Main switch/steering lock

EAU10474

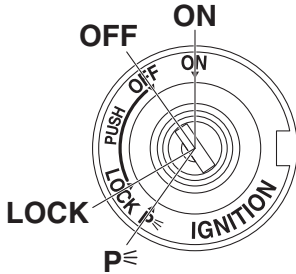

The main switch/steering lock controls the ignition and lighting systems, and is used to lock the steering. The various positions are described below.

TIP

Be sure to use the standard key (black bow) for regular use of the vehicle. To minimize the risk of losing the code re-registering key (red bow), keep it in a safe place and only use it for code re-registering.

ON

EAU85040

All electrical circuits are supplied with power and the vehicle lights are turned on. The engine can be started. The key cannot be removed.

TIP

- To prevent battery discharge, do not leave the key in the on position without the engine running.
- The headlight comes on automatically when the engine is started.

OFF

EAU10662

All electrical systems are off. The key can be removed.

WARNING

EWA10062

Never turn the key to “OFF” or “LOCK” while the vehicle is moving. Otherwise the electrical systems will be switched off, which may result in loss of control or an accident.

LOCK

EAU10696

The steering is locked and all electrical systems are off. The key can be removed.

To lock the steering

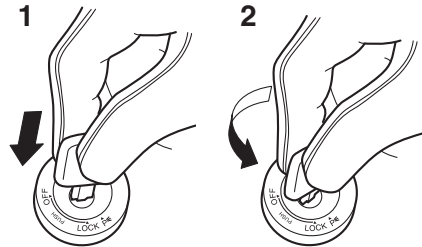

1. Push.
2. Turn.

1. Turn the handlebars all the way to the left or right.
2. With the key in the “OFF” position, push the key in and turn it to “LOCK”.
3. Remove the key.

TIP

If the steering will not lock, try turning the handlebars back to the right or left slightly.

Instrument and control functions

EAU4939G

To unlock the steering

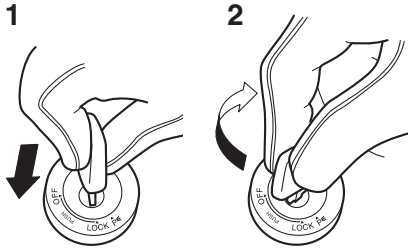

1. Push.
2. Turn.

From the “LOCK” position, push the key and turn it to “OFF”.

P (Parking)

EAU59680

The hazard lights and turn signal lights can be turned on, but all other electrical systems are off. The key can be removed.

The steering must be locked before the key can be turned to “P”.

ECA20760

NOTICE

Using the hazard or turn signal lights for an extended length of time may cause the battery to discharge.

Indicator lights and warning lights

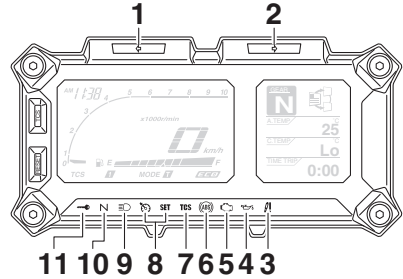

1. Left turn signal indicator light “”
2. Right turn signal indicator light “”
3. Suspension system warning light “”
4. Oil level warning light “”
5. Engine trouble warning light “”
6. ABS warning light “”
7. Traction control system indicator light “TCS”
8. Cruise control indicator lights “” “SET”
9. High beam indicator light “”
10. Neutral indicator light “N”
11. Immobilizer system indicator light “”

Turn signal indicator lights “” and “”

EAU11032

Each indicator light will flash when its corresponding turn signal lights are flashing.

Neutral indicator light “N”

EAU11061

This indicator light comes on when the transmission is in the neutral position.

High beam indicator light “”

EAU11081

This indicator light comes on when the high beam of the headlight is switched on.

Instrument and control functions

3

Oil level warning light “”

EAU11259

This warning light comes on when the engine oil level is low. To prevent engine damage, replenish the engine oil as soon as possible.

Even if the oil level is sufficient, the warning light may flicker when riding on a slope or during sudden acceleration or deceleration, but this is not a malfunction. If a problem is detected in the oil level detection circuit, the oil level warning light will flash repeatedly. If this occurs, have a Yamaha dealer check the vehicle.

TIP

When the vehicle is turned on, the light will come on for a few seconds and then go off. If the light does not come on, or if the light remains on after confirming that the oil level is correct (see page 6-10), have a Yamaha dealer check the vehicle.

Cruise control indicator lights “” and “SET”

EAU58402

These indicator lights come on when the cruise control system is activated. (See page 3-6.)

TIP

When the vehicle is turned on, these lights should come on for a few seconds and then go off. If the lights do not come on, have a Yamaha dealer check the vehicle.

Engine trouble warning light “”

EAU73172

This warning light comes on if a problem is detected in the engine or other vehicle control system. If this occurs, have a Yamaha dealer check the on-board diagnostic system.

TIP

When the vehicle is turned on, the light will come on for a few seconds and then go off. If the light does not come on, or if the light remains on, have a Yamaha dealer check the vehicle.

ABS warning light “”

EAU58532

In normal operation, the ABS warning light comes on when the vehicle is turned on and goes off after traveling at a speed of 10 km/h (6 mi/h) or higher.

If the ABS warning light:

- does not come on when the vehicle is turned on
- does not go off after traveling 10 km/h (6 mi/h)
- comes on or flashes while riding

then the ABS (3-26) may not work correctly. If any of the above occurs, have a Yamaha dealer check the vehicle as soon as possible.

EWA16041

WARNING

If the ABS warning light does not go off after traveling at a speed of 10 km/h (6 mi/h) or higher, or if the warning light comes on or flashes while riding, the brake system reverts to conventional braking. If either of the above occurs, or if the warning light does not come on at all, use extra caution to avoid possible wheel lock during emergency

braking. Have a Yamaha dealer check the brake system and electrical circuits as soon as possible.

Traction control system indicator light “TCS”

EAU74082

This indicator light will flash when traction control has engaged.

If the traction control system is turned off, this indicator light will come on.

TIP

When the vehicle is turned on, the light should come on for a few seconds and then go off. If the light does not come on, or if the light remains on, have a Yamaha dealer check the vehicle.

Suspension system warning light “!

EAU55393

This warning light comes on if a problem is detected in the electronically adjustable suspension system.

TIP

When the vehicle is turned on, the light should come on for a few seconds and then go off. If the light does not come on, or if the light remains on, have a Yamaha dealer check the vehicle.

Immobilizer system indicator light “—”

EAU73120

When the key is turned to “OFF” and 30 seconds have passed, the indicator light will flash steadily to indicate the immobilizer system is enabled. After 24 hours have passed, the indicator light will stop flashing, however the immobilizer system is still enabled.

The electrical circuit of the indicator light can be checked by turning the key to “ON”. The indicator light should come on for a few seconds, and then go off.

If the indicator light does not come on initially when the key is turned to “ON”, if the indicator light remains on, or if the indicator light flashes in a pattern (if a problem is detected in the immobilizer system, the immobilizer system indicator light will flash in a pattern), have a Yamaha dealer check the vehicle.

TIP

If the immobilizer system indicator light flashes in the pattern, slowly 5 times then quickly 2 times, this could be caused by transponder interference. If this occurs, try the following.

1. Make sure there are no other immobilizer keys close to the main switch. Other immobilizer system keys may cause signal interference and prevent the engine from starting.
2. Use the code re-registering key to start the engine.
3. If the engine starts, turn it off, and try starting the engine with the standard keys.
4. If one or both of the standard keys do not start the engine, take the vehicle and all 3 keys to a Yamaha dealer to have the standard keys re-registered.

Instrument and control functions

EAU59132

Cruise control system

This model is equipped with a cruise control system designed to maintain a set cruising speed.

The cruise control system operates only when riding in 3rd gear at speeds between about 50 km/h (31 mi/h) and 100 km/h (62 mi/h), 4th gear at speeds between about 50 km/h (31 mi/h) and 150 km/h (93 mi/h), or 5th or 6th gear at speeds between about 50 km/h (31 mi/h) and 180 km/h (112 mi/h).

⚠ WARNING

- **Improper use of the cruise control system may result in loss of control, which could lead to an accident. Do not activate the cruise control system in heavy traffic, poor weather conditions, or among winding, slippery, hilly, rough or gravel roads.**
- **When traveling uphill or downhill, the cruise control system may not be able to maintain the set cruising speed.**
- **To prevent accidentally activating the cruise control system, turn it off when not in use. Make sure that the cruise control system indicator light “

EWA16341**

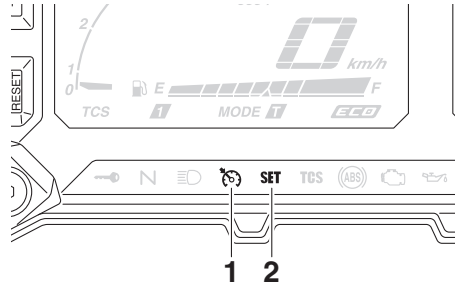

1. Cruise control system indicator light “A line drawing of the motorcycle's handlebar controls. On the left side, there is a cruise control power switch (2) with a symbol of a car with a steering wheel and a speedometer. On the right side, there is a cruise control setting switch (1) with a symbol of a car with a steering wheel and a speedometer.

1. Cruise control setting switch “RES+/SET-”
2. Cruise control power switch “

Activating and setting the cruise control system

1. Push the cruise control power switch “A line drawing of the motorcycle's handlebar controls and instrument cluster. On the left handlebar, the cruise control power switch (1) is shown with an arrow pointing to it. On the right handlebar, the cruise control setting switch is shown. In the instrument cluster, the cruise control system indicator light (2) is shown illuminated with a lightbulb symbol inside it.

1. Cruise control power switch “

3-6

Instrument and control functions

2. Push the “SET-” side of the cruise control setting switch to activate the cruise control system. Your current traveling speed will become the set cruising speed. The cruise control setting indicator light “SET” will come on.

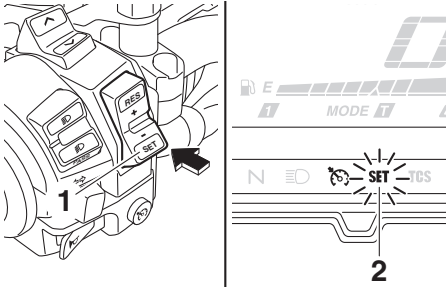

1. Cruise control setting switch “RES+/SET-”
2. Cruise control setting indicator light “SET”

Adjusting the set cruising speed

While the cruise control system is operating, push the “RES+” side of the cruise control setting switch to increase the set cruising speed or the “SET-” side to decrease the set speed.

TIP

Pushing the setting switch once will change the speed in increments of approximately 2.0 km/h (1.2 mi/h). Holding the “RES+” or “SET-” side of the cruise control setting switch down will increase or decrease the speed continuously until the switch is released.

You can also manually increase your traveling speed using the throttle. After you have accelerated, you can set a new cruising speed by pushing the “SET-” side of the setting switch. If you do not set a new cruising speed, when

you return the throttle grip, the vehicle will decelerate to the previously set cruising speed.

Deactivating the cruise control system

Perform one of the following operations to cancel the set cruising speed. The “SET” indicator light will go off.

- Turn the throttle grip past the closed position in the deceleration direction.

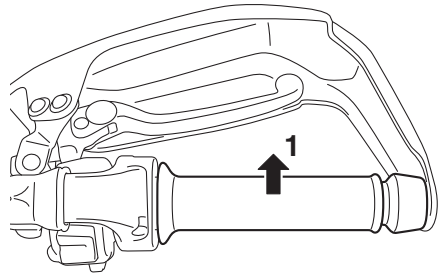

1. Deceleration direction

- Apply the front or rear brake.
- Disengage the clutch.

Push the power switch to turn off the cruise control system. The “” indicator light and the “SET” indicator light will go off.

TIP

Traveling speed decreases as soon as the cruise control system is deactivated; unless the throttle grip is turned.

Using the resume function

Push the “RES+” side of the cruise control setting switch to reactivate the cruise control system. The traveling speed will return to the previously set cruising speed. The “SET” indicator light will come on.

Instrument and control functions

EWA16351

WARNING

It is dangerous to use the resume function when the previously set cruising speed is too high for current conditions.

TIP



Pushing the power switch while the system is operating will turn the system off completely and erase the previously set cruising speed. You will not be able to use the resume function until a new cruising speed has been set.

Automatic deactivation of the cruise control system

The cruise control system for this model is electronically controlled and is linked with the other control systems. The cruise control system will automatically become deactivated under the following conditions:

- The cruise control system is not able to maintain the set cruising speed.
- Wheel slip or wheel spin is detected. (If the traction control system has not been turned off, the traction control system will work.)
- The start/engine stop switch is set to the “” position.
- The engine stalls.
- The sidestand is lowered.

When traveling with a set cruising speed, if the cruise control system is deactivated under the above conditions, the “” indicator light will go off and the “SET” indicator light will flash for 4 seconds, and then go off.

When not traveling with a set cruising speed, if the start/engine stop switch is set to the “” position, the engine stalls, or the sidestand is lowered, then the “” indicator light will go off (the “SET” indicator light will not flash).

If the cruise control system is automatically deactivated, please stop and confirm that your vehicle is in good operating condition.

Before using the cruise control system again, activate it using the power switch.

TIP

In some cases, the cruise control system may not be able to maintain the set cruising speed when the vehicle is traveling uphill or downhill.

- When the vehicle is traveling uphill, the actual traveling speed may become lower than the set cruising speed. If this occurs, accelerate to the desired traveling speed using the throttle.
 - When the vehicle is traveling downhill, the actual traveling speed may become higher than the set cruising speed. If this occurs, the setting switch cannot be used to adjust the set cruising speed. To reduce the traveling speed, apply the brakes. When the brakes are applied, the cruise control system will become deactivated.
-

Instrument and control functions

Multi-function meter unit

EAU80551

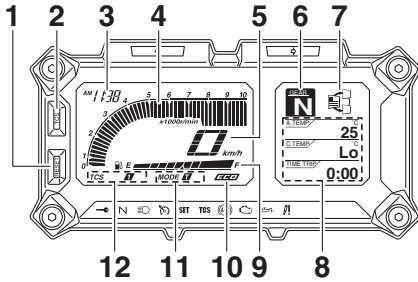

1. "RESET" button
2. "TCS" button
3. Clock
4. Tachometer
5. Speedometer
6. Transmission gear indicator
7. Function display
8. Information display
9. Fuel meter
10. Eco indicator "ECO"
11. Drive mode indicator
12. Traction control system indicator

WARNING

Be sure to stop the vehicle before making any setting changes to the multi-function meter unit. Changing settings while riding can distract the operator and increase the risk of an accident.

The multi-function meter unit is equipped with:

- speedometer
- tachometer
- clock
- fuel meter
- eco indicator
- transmission gear indicator
- drive mode indicator
- traction control system indicator
- function display

- information display
- setting mode

TIP

The select switch " \wedge/\vee " and the menu switch "MENU" are located on the left handlebar. These switches allow you to control or change the settings of the multi-function meter unit.

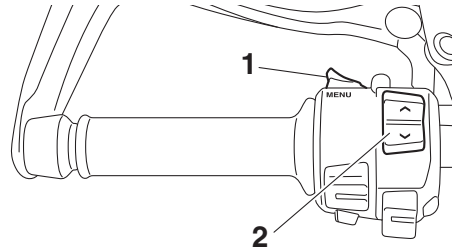

1. Menu switch "MENU"
2. Select switch " \wedge/\vee "

TIP

Be sure to turn the key to "ON" before pushing the select switch " \wedge/\vee ", menu switch "MENU", "RESET" button and "TCS" button.

Speedometer

The speedometer shows the vehicle's traveling speed.

To switch between kilometers and miles, see "Selecting the units" on page 3-18.

EWA12423

Instrument and control functions

Tachometer

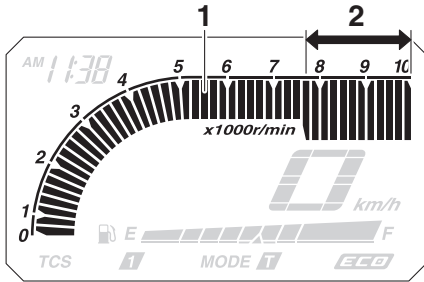

1. Tachometer
2. High-r/min zone

The tachometer shows the engine speed.

ECA23050

NOTICE

Do not operate the engine in the tachometer high-r/min zone.

High-r/min zone: 7750 r/min and above

Fuel meter

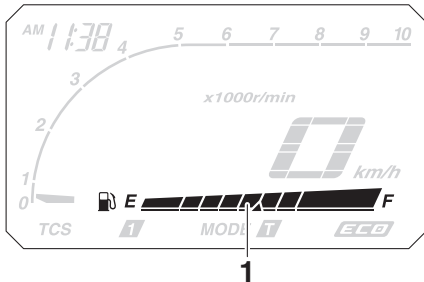

1. Fuel meter

The fuel meter indicates the amount of fuel in the fuel tank. The display segments of the fuel meter disappear from “F” (full) towards “E” (empty) as the fuel level decreases. When the last segment starts flashing, refuel as soon as possible.

TIP

If a problem is detected in the fuel meter circuit, all display segments of the fuel meter will start flashing. If this occurs, have a Yamaha dealer check the vehicle.

Eco indicator

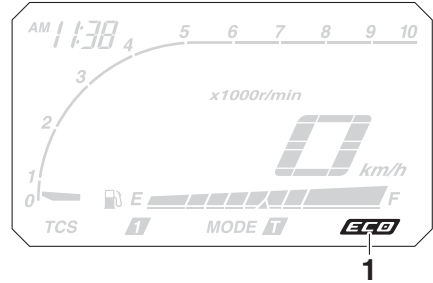

1. Eco indicator “ECO”

This indicator comes on when the vehicle is being operated in an environmentally friendly, fuel-efficient manner. The indicator goes off when the vehicle is stopped.

TIP

Consider the following tips to reduce fuel consumption:

- Avoid high engine speeds during acceleration.
- Travel at a constant speed.
- Select the transmission gear that is appropriate for the vehicle speed.

Instrument and control functions

Transmission gear indicator

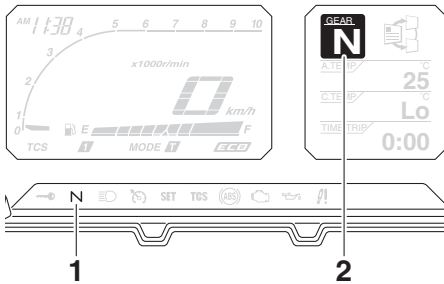

1. Neutral indicator light “N”
2. Transmission gear indicator

This indicator shows the current transmission gear and neutral position as follows: 1-N-2-3-4-5-6. When the clutch lever is pulled or the vehicle is stopped, “-” will be displayed.

Drive mode indicator

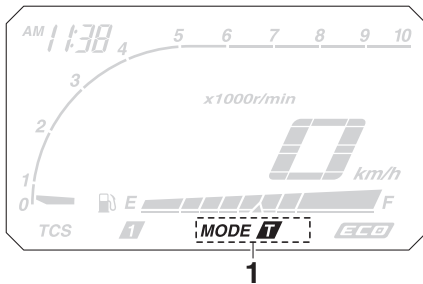

1. Drive mode indicator

This indicator shows the current drive mode: Touring mode “T” or sports mode “S”. For more information on the modes and on how to select them, see pages 3-21 and 3-23.

Traction control system indicator

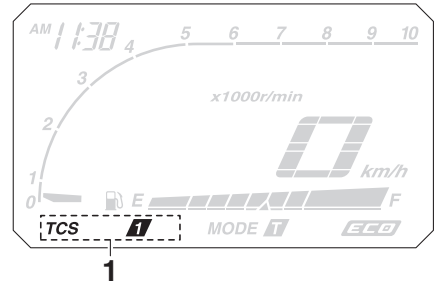

1. Traction control system indicator

This indicator shows the current traction control mode: “1”, “2” or “OFF”. For more information on the traction control system, see page 3-27.

Function display

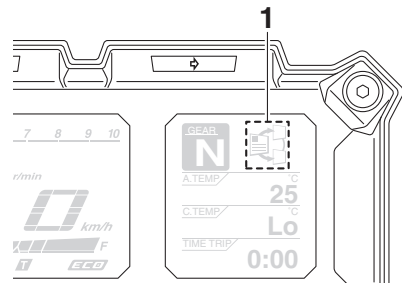

1. Function display

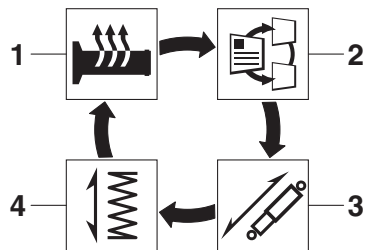

1. Grip warmer adjusting function
2. Information display selection function
3. Damping force adjusting function
4. Preload adjusting function

Instrument and control functions

ECA17932

Push the menu switch “MENU” to switch the display between the following functions. The display changes each time the switch is pushed.

- Grip warmer adjusting function
- Information display selection function
- Damping force adjusting function
- Preload adjusting function

3





TIP

The preload adjusting function will appear only when the vehicle is stopped with the engine running.

The following pages contain explanation of the grip warmer and information display functions. See page 3-35 for an explanation of the preload and damping force adjusting functions.

Adjusting the grip warmer

This vehicle is equipped with grip warmers, which can only be used when the engine is running. There are 4 grip warmer settings.

Setting	Display
Off	
Low	
Middle	
High	

To increase the grip warmer temperature, push the “^” side of the select switch. To decrease the grip warmer temperature, push the “v” side of the select switch.

NOTICE

- Be sure to wear gloves when using the grip warmers.
- Do not use the grip warmers in warm weather.
- If the handlebar grip or throttle grip becomes worn or damaged, stop using the grip warmers and replace the grips.

Selecting the information display

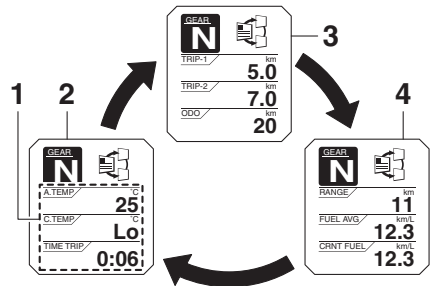

1. Information display
2. Display-1
3. Display-2
4. Display-3

There are 3 information display pages. Push the select switch rotate between them.

You can select and arrange which items will be shown on each information display page. (See page 3-19.) The following items are available:

- odometer
- tripmeters
- fuel reserve tripmeter
- estimated traveling range
- elapsed time
- air intake temperature
- coolant temperature
- average fuel consumption
- instantaneous fuel consumption

Instrument and control functions

Odometer:

ODO / km
20

The odometer shows the total distance traveled by the vehicle.

Tripmeters:

TRIP-1 / km
5.0

TRIP-2 / km
7.0

“TRIP-1” and “TRIP-2” show the distance traveled since they last reset.

TIP

- The odometer will lock at 999999.
- The tripmeters will reset and continue counting after 9999.9 is reached.

The fuel reserve tripmeter shows the distance traveled on the fuel reserve. When approximately 3.9 L (1.03 US gal, 0.86 Imp.gal) of fuel remains in the fuel tank, the last segment of the fuel meter starts flashing. In addition, the information display will automatically change to the fuel reserve tripmeter “TRIP-F” and start counting the distance traveled from that point.



In this case, push the select switch to rotate among the information display pages in the following order;

TRIP-F → Display-1 → Display-2 → Display-3 → TRIP-F

To reset a tripmeter, push the “RESET” button briefly so that the tripmeter flashes, and then push and hold the “RESET” button for 2 seconds.

TIP

The fuel reserve tripmeter can be reset manually, or after refueling and traveling 5 km (3 mi), it will reset automatically and disappear from the display.

Estimated traveling range:

RANGE / km
11

This shows the approximate distance that can be traveled with the remaining fuel under current riding conditions.

Elapsed time:

TIME TRIP /
0:06

Instrument and control functions

This timer shows the elapsed time since the key was turned to “ON”. The maximum time that can be shown is 99:59.

This timer automatically resets when the key is turned to “OFF”.

TIP

There are also “TIME-2” and “TIME-3” timer functions, but they cannot be set to the information display pages. See “Setting mode” on page 3-15 for more information.

Air intake temperature:

A.TEMP / °C
25

This shows the temperature of the air drawn into the air filter case. The display range is -9 °C to 93 °C in 1 °C increments.

TIP

- The displayed temperature may vary from the actual ambient temperature.
- The temperature reading may be affected by engine heat when riding slowly (under 20 km/h [12 mi/h]) or when stopped at traffic signals, etc.

Coolant temperature:

C.TEMP / °C
Lo

This shows the temperature of the coolant. The coolant temperature will vary with changes in the ambient temperature and engine load.

If the message “Hi” flashes, stop the vehicle, then stop the engine and let the engine cool. (See page 6-41.)

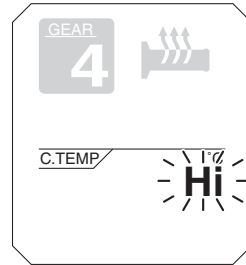

TIP

The information display pages cannot be rotated when the engine overheat message “Hi” is flashing.

ECA10022

NOTICE

Do not continue to operate the engine if it is overheating.

Average fuel consumption:

FUEL AVG / km/L
12.3

This function calculates the average fuel consumption since it was last reset. The average fuel consumption can be displayed as “km/L”, “L/100km” or “MPG”.

- “km/L” shows the number of kilometers traveled on one liter of fuel.
- “L/100km” shows how many liters of fuel is needed to travel 100 km.

Instrument and control functions

- “MPG” shows the number of miles traveled per Imp.gallon of fuel.

TIP

See “Selecting the units” on page 3-18 to change the kilometer-based fuel consumption units or to switch to miles.

To reset the average fuel consumption, push the “RESET” button briefly so that the average fuel consumption display flashes, and then push and hold the “RESET” button for 2 seconds.

TIP

After resetting the average fuel consumption, “_ _.” will be shown until the vehicle has traveled 1 km (0.6 mi).

ECA15474

NOTICE

If there is a malfunction, “- _.” will be continuously displayed. Have a Yamaha dealer check the vehicle.

Instantaneous fuel consumption:

CRNT FUEL / km/L
12.3

This function calculates the instantaneous fuel consumption under current riding conditions. The instantaneous fuel consumption can be displayed as “km/L”, “L/100km” or “MPG”.

- “km/L” shows the number of kilometers traveled on one liter of fuel.
- “L/100km” shows how many liters of fuel is needed to travel 100 km.
- “MPG” shows the number of miles traveled per Imp.gallon of fuel.

TIP

- See “Selecting the units” on page 3-18 to change the kilometer-based fuel consumption units or to switch to miles.
- When traveling under 10 km/h (6 mi/h), “_ _.” will be displayed.

ECA15474

NOTICE

If there is a malfunction, “- _.” will be continuously displayed. Have a Yamaha dealer check the vehicle.

Setting mode

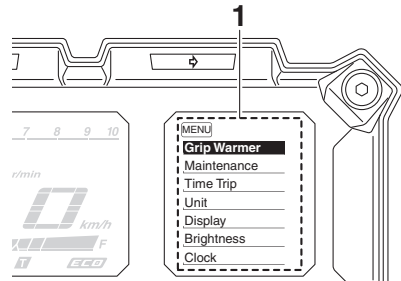

1. Setting mode display

The setting mode allows you to set, select, or reset the items shown in the information display and its pages.

TIP

- The transmission must be in neutral and the vehicle must be stopped to change settings in this mode.
- Shifting the transmission into gear and starting off, or turning the key to “OFF”, saves all setting changes made and exits the setting mode.

Instrument and control functions

Push and hold the menu switch “MENU” for 2 seconds to enter the setting mode. To exit the setting mode and return to the normal display, push and hold the menu switch “MENU” again for 2 seconds.

Display	Description
Grip Warmer	Set the low, middle, and high settings to 10 temperature levels.
Maintenance	Check and reset the “OIL” oil change interval (distance traveled since last oil change), and the “FREE-1” and “FREE-2” maintenance intervals.
Time Trip	Check and reset the “TIME-2” and “TIME-3” timers. These timers show the total elapsed time that the key has been in the “ON” position. When the key is turned to “OFF”, these timers stop counting but are not reset. The maximum time that can be shown is 99:59. When the time trips exceed 99:59, they will reset and continue counting.
Unit	Switch the multi-function meter distance units between kilometers and miles. When kilometers are selected, the fuel consumption units can be switched between “L/100km” and “km/L”.
Display	Arrange the items shown in the 3 information display pages.
Brightness	Adjust the brightness of the multi-function meter unit.
Clock	Set the clock. The clock displays time in 12-hour format.
All Reset	Reset all items, except the odometer and the clock.

Adjusting the temperature levels of the grip warmer settings

1. Use the select switch to highlight “Grip Warmer”.

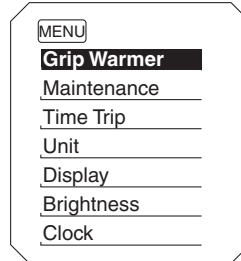

2. Push the menu switch “MENU”. The grip warmer setting display will be shown and “High” will flash in the display.

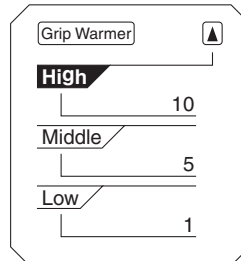

3. Push the menu switch “MENU”. The temperature level for the high setting will start flashing. Use the select switch to set the temperature level, and then push the menu switch “MENU”. “High” will start flashing.

Instrument and control functions

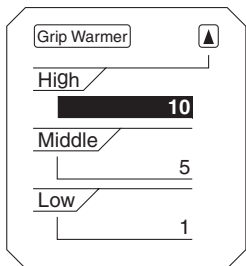

4. Use the select switch to highlight “Middle” or “Low”, and then change the setting using the same procedure that was used for the high setting.
5. When you are finished changing the settings, use the select switch to highlight “▲”, and then push the menu switch “MENU” to return to the setting mode main screen.

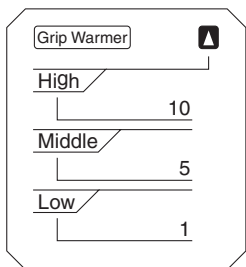

TIP

The setting can be set to 10 temperature levels.

Resetting the maintenance intervals

1. Use the select switch to highlight “Maintenance”.

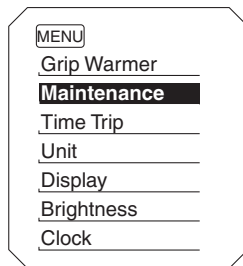

2. Push the menu switch “MENU”, and then push the “RESET” button to select the item to reset.

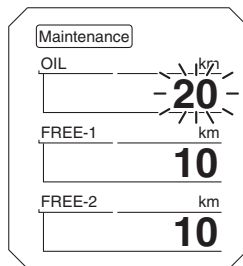

3. While the selected item is flashing, push and hold the “RESET” button for 2 seconds.
4. Push the menu switch “MENU” to return to the setting mode main screen.

Checking and resetting “TIME-2” and “TIME-3”

1. Use the select switch to highlight “Time Trip”.

Instrument and control functions

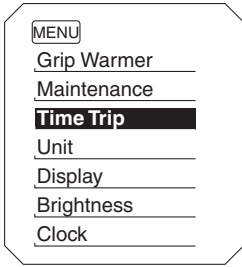

2. Push the menu switch “MENU” to display “TIME-2” and “TIME-3”. To reset a time trip, push the “RESET” button to select the item to reset.

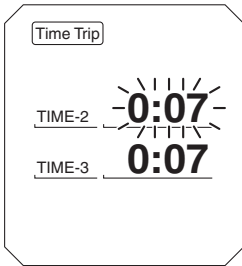

3. While the selected item is flashing, push and hold the “RESET” button for 2 seconds.
4. Push the menu switch “MENU” to return to the setting mode main screen.

Selecting the units

1. Use the select switch to highlight “Unit”.

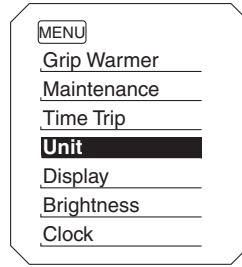

2. Push the menu switch “MENU”. The unit setting display will be shown and “km or mile” will flash in the display.

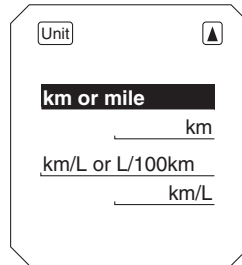

3. Push the menu switch “MENU”. “km” or “mile” will flash in the display.

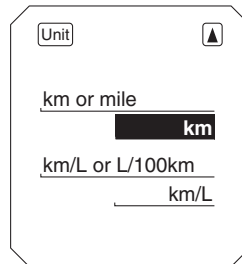

4. Use the select switch to select “km” or “mile”, and then push the menu switch “MENU”.

Instrument and control functions

TIP

When “km” is selected, “L/100km” or “km/L” can be set as the fuel consumption units. To set the fuel consumption units, proceed as follows. If “mile” was selected, skip steps 5 and 6.

5. Use the select switch to select “km/L or L/100km”.
6. Push the menu switch “MENU”, use the select switch to select “L/100km” or “km/L”, and then push the menu switch “MENU” again.
7. Use the select switch to highlight “”, and then push the menu switch “MENU” to return to the setting mode menu.

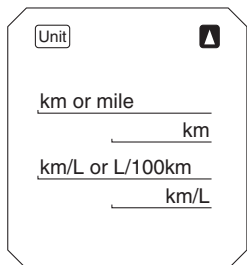

Selecting the information display page items

1. Use the select switch to highlight “Display”.

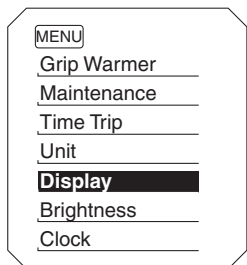

2. Push the menu switch “MENU”, use the select switch to highlight the page you want to adjust, and then push the menu switch “MENU” again.

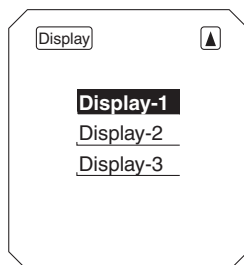

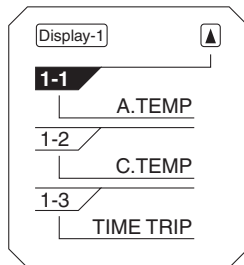

3. Use the select switch to highlight the item you want to change, and then push the menu switch “MENU”.

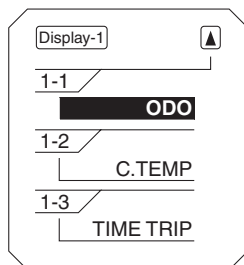

4. Use the select switch to select the item that you want to appear, and then push the menu switch “MENU” to confirm the selection.

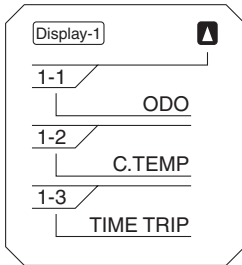

Instrument and control functions

- Repeat the previous step to make other item changes, or if you are finished adjusting the information display page items, use the select switch to highlight “

A screenshot of the 'Display-1' menu. At the top left is a box labeled 'Display-1' and at the top right is an upward-pointing arrow icon. Below these are three menu items, each with a horizontal line and a diagonal slash to its left: '1-1 ODO', '1-2 C.TEMP', and '1-3 TIME TRIP'.

- Use the select switch to highlight “

Adjusting the multi-function meter unit brightness

- Use the select switch to highlight “Brightness”.

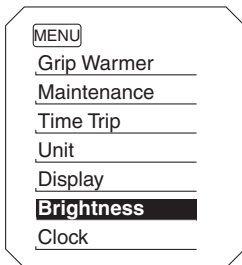

- Push the menu switch “MENU”.
- Use the select switch to select the desired brightness level, and then push the menu switch “MENU” to return to the setting mode main screen.

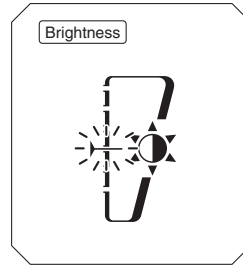

Setting the clock

- Use the select switch to highlight “Clock”.

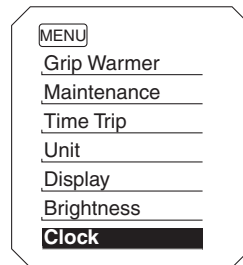

- Push the menu switch “MENU”.
- When the hour digits start flashing, use the select switch to set the hours.

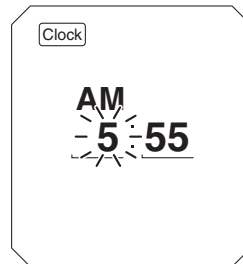

- Push the menu switch “MENU”, and the minute digits start flashing.
- Use the select switch to set the minutes.

Instrument and control functions

EAU49433

6. Push the menu switch “MENU” to return to the setting mode main screen.

Resetting all of the display items

1. Use the select switch to highlight “All Reset”.

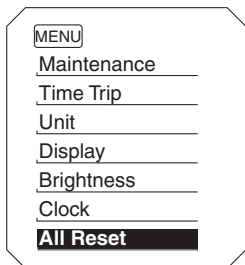

2. Push the menu switch “MENU”.
3. Use the select switch to highlight “YES”, and then push the menu switch “MENU”.

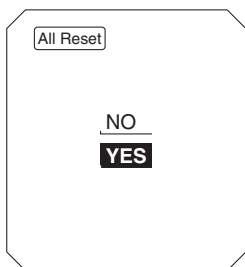

TIP

The odometer and the clock will not be reset.

D-mode (drive mode)

D-mode is an electronically controlled engine performance system with two mode selections (touring mode “T” and sports mode “S”).

Push the drive mode switch “MODE” to switch between modes. (See page 3-23 for an explanation of the drive mode switch.)

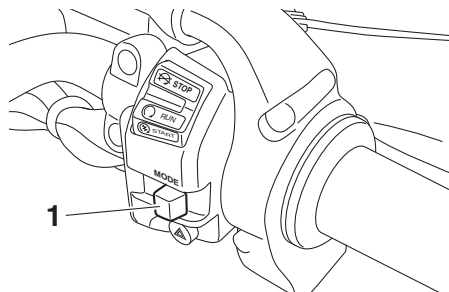

1. Drive mode switch “MODE”

TIP

Before using D-mode, make sure you understand its operation along with the operation of the drive mode switch.

Touring mode “T”

The touring mode “T” is suitable for various riding conditions.

This mode allows the rider to enjoy smooth drivability from the low-speed range to the high-speed range.

Sports mode “S”

This mode offers a sportier engine response in the low- to mid-speed range compared to the touring mode.

Instrument and control functions

Handlebar switches

EAU1234M

Left

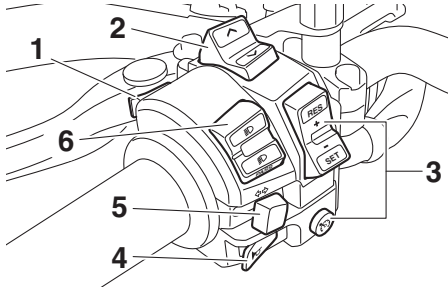

1. Menu switch “MENU”
2. Select switch “ \wedge / \vee ”
3. Cruise control switches
4. Horn switch “ HORN ”
5. Turn signal switch “ \leftarrow / \rightarrow ”
6. Dimmer/Pass switch “ H/O / H/O /PASS”

Right

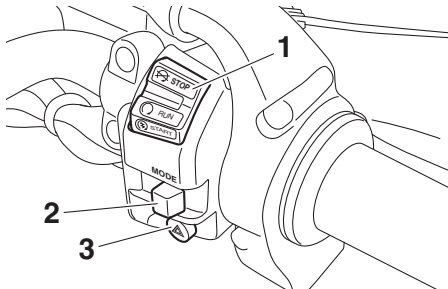

1. Stop/Run/Start switch “ STOP / RUN / START ”
2. Drive mode switch “MODE”
3. Hazard switch “ \triangle ”

Dimmer/Pass switch “ H/O / H/O /PASS”

EAUM4031

Set this switch to “ H/O ” for the high beam and to “ H/O ” for the low beam. To flash the high beam, press the switch down to “PASS” while the headlights are on low beam.

TIP

When the switch is set to low beam, both headlights come on.

When the switch is set to high beam, both headlights come on.

Turn signal switch “ \leftarrow / \rightarrow ”

EAU12461

To signal a right-hand turn, push this switch to “ \rightarrow ”. To signal a left-hand turn, push this switch to “ \leftarrow ”. When released, the switch returns to the center position. To cancel the turn signal lights, push the switch in after it has returned to the center position.

Horn switch “ HORN ”

EAU12501

Press this switch to sound the horn.

Stop/Run/Start switch “ STOP / RUN / START ”

EAU54212

To crank the engine with the starter, set this switch to “ RUN ”, and then push the switch down towards “ START ”. See page 5-2 for starting instructions prior to starting the engine.

Set this switch to “ STOP ” to stop the engine in case of an emergency, such as when the vehicle overturns or when the throttle cable is stuck.

Hazard switch “ \triangle ”

EAU12735

With the key in the “ON” or “P” position, use this switch to turn on the hazard lights (simultaneous flashing of all turn signal lights).

The hazard lights are used in case of an emergency or to warn other drivers when your vehicle is stopped where it might be a traffic hazard.

NOTICE

Do not use the hazard lights for an extended length of time with the engine not running, otherwise the battery may discharge.

Cruise control switches

EAU12781

See page 3-6 for an explanation of the cruise control system.

Menu switch “MENU”

EAU54232

This switch is used to make setting changes within the multi-function meter unit. (See page 3-9.)

Select switch “^/√”

EAU54222

This switch is used to make setting changes within the multi-function meter unit. (See page 3-9.)

Drive mode switch “MODE”

EAU54691

EWA15341

! WARNING

Do not change the D-mode while the vehicle is moving.

Using this switch changes the drive mode to touring mode “T” or sports mode “S”.

The throttle grip must be completely closed in order to change the drive mode.

The selected mode is shown on the drive mode display. (See page 3-11.)

The drive mode cannot be changed while the cruise control system is operating.

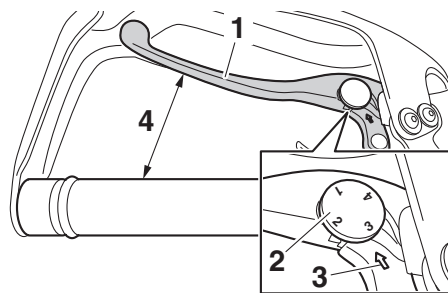
Clutch lever

1. Clutch lever
2. Clutch lever position adjusting dial
3. Match mark
4. Distance

The clutch lever is located on the left side of the handlebar. Pull the clutch lever to disengage the engine from the drivetrain. Release the lever to engage the clutch and transmit power to the rear wheel.

TIP

- The lever should be pulled rapidly and released slowly for smooth shifting. (See page 5-3.)
- The clutch lever is equipped with a switch, which is part of the ignition circuit cut-off system. (See page 3-43.)

The position of the clutch lever can be adjusted. To adjust the distance between the clutch lever and the handlebar, gently push the lever away from the handlebar and rotate the position adjusting dial.

TIP

Make sure the setting number on the position adjusting dial aligns with the match mark.

Instrument and control functions

EAU12876

EAU4951B

Shift pedal

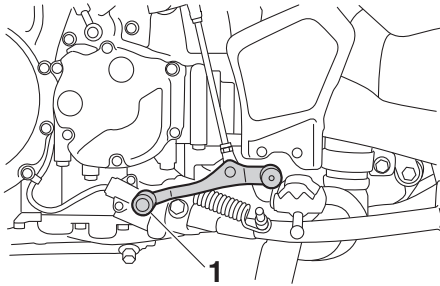

1. Shift pedal

The shift pedal is located on the left side of the motorcycle. To shift the transmission to a higher gear, move the shift pedal up. To shift the transmission to a lower gear, move the shift pedal down. (See page 5-3.)

Brake lever

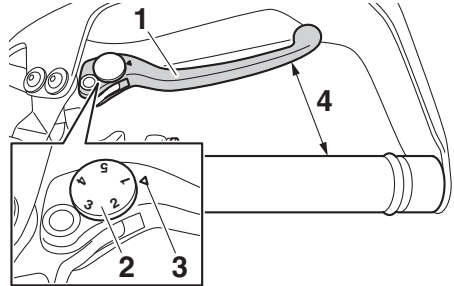

1. Brake lever
2. Brake lever position adjusting dial
3. Match mark
4. Distance

The brake lever is located on the right side of the handlebar. To apply the front brake, pull the lever toward the throttle grip.

The brake lever is equipped with a brake lever position adjusting dial. To adjust the distance between the brake lever and the throttle grip, slightly pull the brake lever away from the throttle grip and rotate the adjusting dial. Make sure the setting number on the adjusting dial aligns with the match mark on the brake lever.

Unified brake system (UBS)

When pulling the brake lever, the front brake and a portion of the rear brake are applied. For full braking performance, apply both the brake lever and the brake pedal simultaneously.

The unified brake system is monitored by an ECU, which disables unified braking and resumes conventional braking if a malfunction occurs.

TIP

- UBS does not function until the vehicle starts moving. However, after coming to a stop while applying the brake lever, UBS will remain engaged. As UBS applies only a portion of the rear brake, depress the brake pedal when stopping on a steep or slippery slope.
- UBS will disengage when stopped and the brake lever is released.
- UBS does not function when the brake pedal is applied before the brake lever.
- UBS is activated via the front brake lever only.
- Resistance and vibration may be felt in the brake pedal when UBS is engaged.

Brake pedal

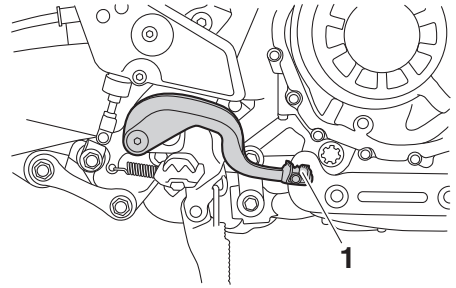

1. Brake pedal

The brake pedal is located on the right side of the motorcycle. To apply the rear brake, press down on the brake pedal.

TIP

Resistance and vibration may be felt in the brake pedal when UBS is engaged, but this does not indicate a malfunction.

Instrument and control functions

3

ABS

EAU73181

This model's anti-lock brake system (ABS) features a dual electronic control system, which acts on the front and rear brakes independently.

Operate the brakes with ABS as you would conventional brakes. If the ABS is activated, a pulsating sensation may be felt at the brake lever or brake pedal. In this situation, continue to apply the brakes and let the ABS work; do not "pump" the brakes as this will reduce braking effectiveness.

EWA16051

WARNING

Always keep a sufficient distance from the vehicle ahead to match the riding speed even with ABS.

- The ABS performs best with long braking distances.
- On certain surfaces, such as rough or gravel roads, the braking distance may be longer with the ABS than without.

The ABS is monitored by an ECU, which will revert the system to conventional braking if a malfunction occurs.

TIP

- The ABS performs a self-diagnosis test each time the vehicle first starts off after the key is turned to "ON" and the vehicle has traveled at a speed of 10 km/h (6 mi/h) or higher. During this test, a "clicking" noise may be heard from the hydraulic control unit, and if the brake lever or brake pedal is even slightly applied, a vibration can be felt at the lever and pedal, but this does not indicate a malfunction.

- This ABS has a test mode which allows the owner to experience the pulsation at the brake lever or brake pedal when the ABS is operating. However, special tools are required, so please consult your Yamaha dealer.

ECA16831

NOTICE

Keep any type of magnets (including magnetic pick-up tools, magnetic screwdrivers, etc.) away from the front and rear wheel hubs; otherwise, the magnetic rotors equipped in the wheel hubs may be damaged, resulting in improper performance of the ABS and the unified brake system.

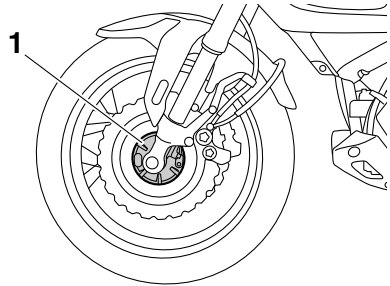

1. Front wheel hub

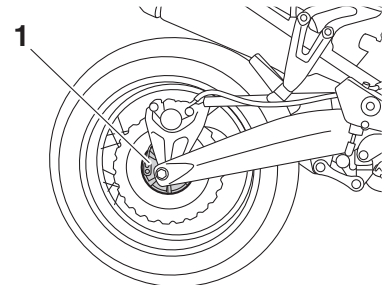

1. Rear wheel hub

Traction control system

EAU58954

The traction control system helps maintain traction when accelerating on slippery surfaces, such as unpaved or wet roads. If sensors detect that the rear wheel is starting to slip (uncontrolled spinning), the traction control system assists by regulating engine power as needed until traction is restored.

EWA15433

WARNING

The traction control system is not a substitute for riding appropriately for the conditions. Traction control cannot prevent loss of traction due to excessive speed when entering turns, when accelerating hard at a sharp lean angle, or while braking, and cannot prevent front wheel slipping. As with any vehicle, approach surfaces that may be slippery with caution and avoid especially slippery surfaces.

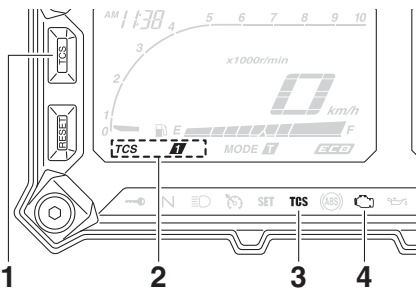

1. "TCS" button
2. Traction control system indicator
3. Traction control system indicator light "TCS"
4. Engine trouble warning light "

The traction control system indicator light flashes when traction control has engaged. You may notice slight changes in engine and exhaust sounds when the system has engaged.

When the vehicle is turned on, the traction control system is turned on and set to "TCS 1". The traction control system modes are as follows.

"TCS 1": Default mode

"TCS 2": Sporty mode

This mode decreases traction control system assist, allowing the rear wheel to spin more freely than "TCS 1".

"TCS OFF": The traction control system is turned off. The system may also be automatically disabled in some riding conditions.

TIP

Use the mode "TCS OFF" to help free the rear wheel if the motorcycle gets stuck in mud, sand, or other soft surfaces.

NOTICE

ECA16801

Use only the specified tires. (See page 6-19.) Using different sized tires will prevent the traction control system from controlling tire rotation accurately.

Setting the traction control system

EWA15441

WARNING

Be sure to stop the vehicle before making any setting changes to the traction control system. Changing settings while riding can distract the operator and increase the risk of an accident.

Instrument and control functions

3

The traction control system mode can be changed only when the vehicle is stopped.

- Push the “TCS” button to change between modes “1” and “2”.
- Push the button for two seconds to select “TCS OFF” and turn the traction control system off. Push the button again to return to the previously selected mode.

4. Have a Yamaha dealer check the vehicle and turn off the engine trouble warning light.

Resetting

The traction control system will disable in the following conditions:

- excessive rear wheel spinning
- the front or rear wheel comes off the ground while riding
- either wheel is rotated with the key turned to “ON” (such as when performing maintenance)

If the traction control system has been disabled, both the traction control system indicator light and the engine trouble warning light come on.

Should this occur, try resetting the system as follows.

1. Stop the vehicle and turn the key to “OFF”.
2. Wait a few seconds and then turn the key back to “ON”.
3. The traction control system indicator light should turn off and the system be enabled.

TIP

If the traction control system indicator light remains on after resetting, the motorcycle may still be ridden. However, have a Yamaha dealer check the vehicle as soon as possible.

Fuel tank cap

EAU13076

EAU13222

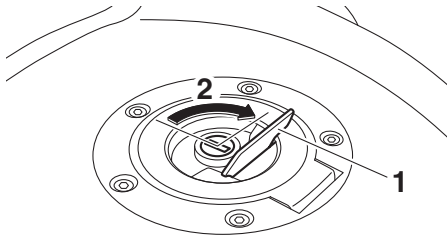

1. Fuel tank cap lock cover
2. Unlock.

To open the fuel tank cap

Open the fuel tank cap lock cover, insert the key into the lock, and then turn it 1/4 turn clockwise. The lock will be released and the fuel tank cap can be opened.

To close the fuel tank cap

With the key still inserted in the lock, push down the fuel tank cap. Turn the key 1/4 turn counterclockwise, remove it, and then close the lock cover.

TIP

The fuel tank cap cannot be closed unless the key is in the lock. In addition, the key cannot be removed if the cap is not properly closed and locked.

EWA11092

WARNING

Make sure that the fuel tank cap is properly closed after filling fuel. Leaking fuel is a fire hazard.

Fuel

Make sure there is sufficient gasoline in the tank.

EWA10882

WARNING

Gasoline and gasoline vapors are extremely flammable. To avoid fires and explosions and to reduce the risk of injury when refueling, follow these instructions.

1. Before refueling, turn off the engine and be sure that no one is sitting on the vehicle. Never refuel while smoking, or while in the vicinity of sparks, open flames, or other sources of ignition such as the pilot lights of water heaters and clothes dryers.
2. Do not overfill the fuel tank. When refueling, be sure to insert the pump nozzle into the fuel tank filler hole. Stop filling when the fuel reaches the bottom of the filler tube. Because fuel expands when it heats up, heat from the engine or the sun can cause fuel to spill out of the fuel tank.

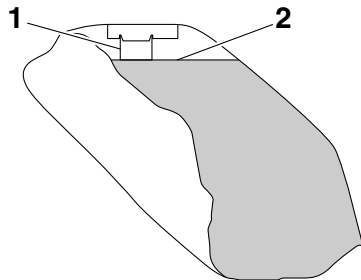

1. Fuel tank filler tube
2. Maximum fuel level

Instrument and control functions

3. Wipe up any spilled fuel immediately. **NOTICE:** Immediately wipe off spilled fuel with a clean, dry, soft cloth, since fuel may deteriorate painted surfaces or plastic parts. [ECA10072]
4. Be sure to securely close the fuel tank cap.

EWA15152

WARNING

3

Gasoline is poisonous and can cause injury or death. Handle gasoline with care. Never siphon gasoline by mouth. If you should swallow some gasoline or inhale a lot of gasoline vapor, or get some gasoline in your eyes, see your doctor immediately. If gasoline spills on your skin, wash with soap and water. If gasoline spills on your clothing, change your clothes.

EAU75300

Recommended fuel:

Premium unleaded gasoline (Gasohol [E10] acceptable)

Fuel tank capacity:

23 L (6.1 US gal, 5.1 Imp.gal)

Fuel reserve amount:

3.9 L (1.03 US gal, 0.86 Imp.gal)

ECA11401

NOTICE

Use only unleaded gasoline. The use of leaded gasoline will cause severe damage to internal engine parts, such as the valves and piston rings, as well as to the exhaust system.



TIP

- This mark identifies the recommended fuel for this vehicle as specified by European regulation (EN228).
- Check that gasoline nozzle has the same identifier when fueling.

Your Yamaha engine has been designed to use premium unleaded gasoline with a research octane number of 95 or higher. If knocking (or pinging) occurs, use a gasoline of a different brand. Use of unleaded fuel will extend spark plug life and reduce maintenance costs.

Gasohol

There are two types of gasohol: gasohol containing ethanol and that containing methanol. Gasohol containing ethanol can be used if the ethanol content does not exceed 10% (E10). Gasohol containing methanol is not recommended by Yamaha because it can cause damage to the fuel system or vehicle performance problems.

Fuel tank overflow hose

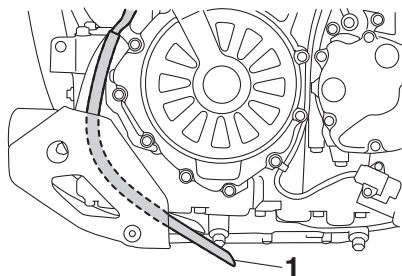

1. Fuel tank overflow hose

Before operating the vehicle:

- Check the fuel tank overflow hose connection.
- Check the fuel tank overflow hose for cracks or damage, and replace it if necessary.
- Make sure that the end of the fuel tank overflow hose is not blocked, and clean it if necessary.
- Make sure that the end of the fuel tank overflow hose is positioned as shown.

TIP

See page 6-10 for canister information.

Catalytic converter

This model is equipped with a catalytic converter in the exhaust system.

EWA10863

WARNING

The exhaust system is hot after operation. To prevent a fire hazard or burns:

- Do not park the vehicle near possible fire hazards such as grass or other materials that easily burn.
- Park the vehicle in a place where pedestrians or children are not likely to touch the hot exhaust system.
- Make sure that the exhaust system has cooled down before doing any maintenance work.
- Do not allow the engine to idle more than a few minutes. Long idling can cause a build-up of heat.

ECA10702

NOTICE

Use only unleaded gasoline. The use of leaded gasoline will cause unreparable damage to the catalytic converter.

Instrument and control functions

EAU49445

Rider seat

- The rider seat height can be adjusted. See the following section.

To remove the rider seat

1. Insert the key into the seat lock, and then turn it counterclockwise.

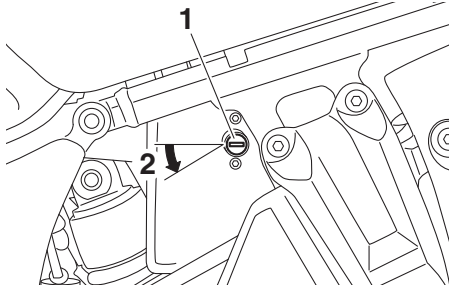

1. Seat lock
2. Unlock.

2. Lift the front of the rider seat and push the seat forward.

To install the rider seat

1. Insert the projection on the rear of the rider seat into the seat holder as shown, and then push the front of the seat down to lock it in place.

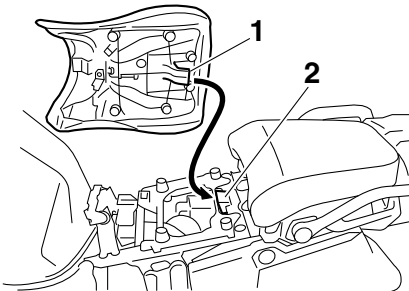

1. Projection
2. Seat holder

2. Remove the key.

TIP

- Make sure that the rider seat is properly secured before riding.

Instrument and control functions

EAU49476

Adjusting the rider seat height

The rider seat height can be adjusted to one of two positions. At factory assembly the rider seat height is set to the high position.

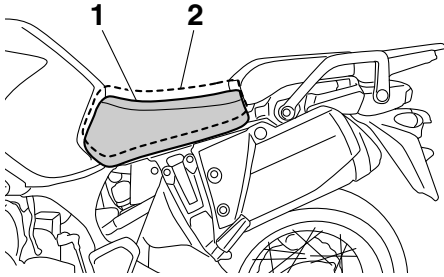

1. Low position
2. High position

To change to the low position

1. Remove the rider seat.
2. Remove the rider seat height position adjuster by pulling it out.

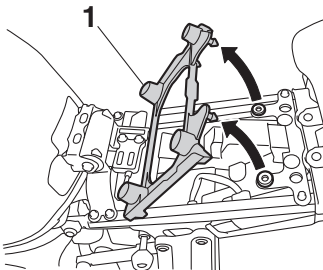

1. Rider seat height position adjuster

3. Install the rider seat height position adjuster so that the match mark is aligned with the “L” mark as shown.

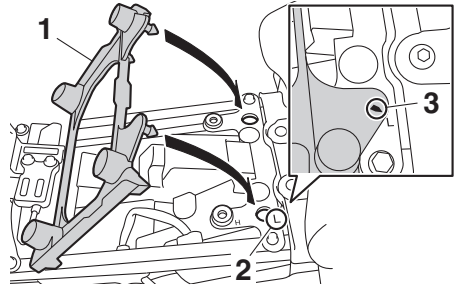

1. Rider seat height position adjuster
2. “L” mark
3. Match mark

4. Insert the projection on the rear of the rider seat into seat holder A as shown.

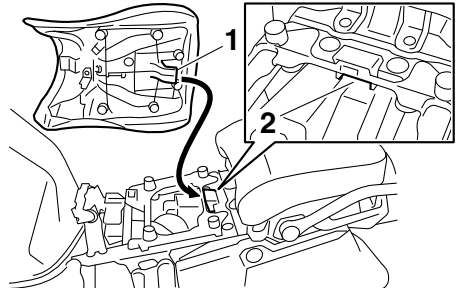

1. Projection
2. Seat holder A (for low position)

To change to the high position

1. Remove the rider seat.
2. Remove the rider seat height position adjuster by pulling it out.

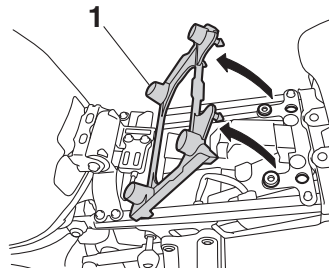

1. Rider seat height position adjuster

Instrument and control functions

EAU58982

3. Install the rider seat height position adjuster so that the match mark is aligned with the "H" mark as shown.

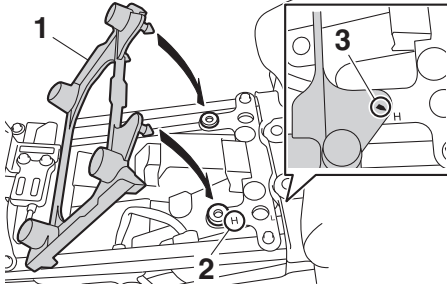

1. Rider seat height position adjuster
2. "H" mark
3. Match mark

4. Insert the projection on the rear of the rider seat into seat holder B as shown.

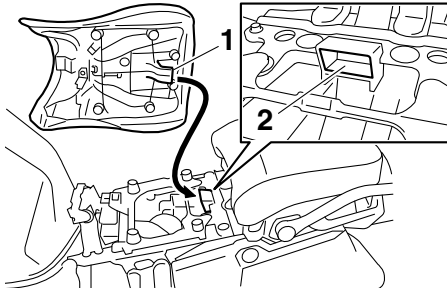

1. Projection
2. Seat holder B (for high position)

TIP

Make sure that the rider seat is properly secured before riding.

Windshield

To suit the rider's preference, the windshield can be changed to one of four positions.

To adjust the windshield height

1. Loosen the windshield height position adjusting knob on each side of the windshield until resistance is felt. **NOTICE: Do not continue turning the knob after resistance is felt. Otherwise, the knob could be damaged.** [ECA20211]

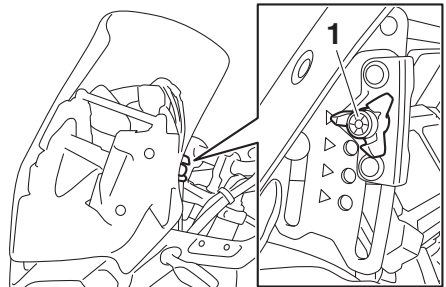

1. Windshield height position adjusting knob
2. Pull the slide plate holders outward, and then adjust the height of the windshield.

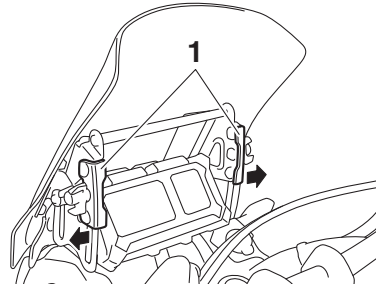

1. Slide plate holder
3. Align the slide plate holders with the match marks at the desired position.

TIP

- Make sure that the slide plate holders are aligned with the match marks at the same height on both sides of the windshield.
- Make sure that the projection on each slide plate holder fits into the corresponding hole in the slide plate.

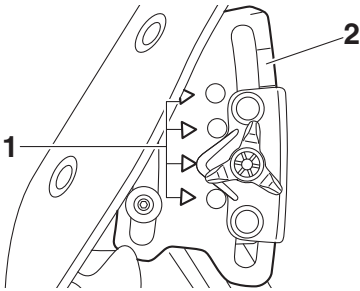

1. Match mark
2. Slide plate

4. Tighten the adjusting knobs.

Adjusting the front and rear suspension

This model is equipped with an electronically adjustable suspension system. The preload of the rear shock absorber and the damping forces of both the front fork and rear shock absorber can be adjusted.

EWA12423

WARNING

Be sure to stop the vehicle before making any setting changes to the multi-function meter unit. Changing settings while riding can distract the operator and increase the risk of an accident.

Preload

When riding with luggage or a passenger, use the preload adjusting function to adjust the suspension system to match the load. There are 4 preload settings.

TIP

- The preload adjusting function will appear only when the engine is running.
- Changing the preload setting will also adjust the front and rear suspension damping forces accordingly. (See page 3-37.)
- About cold temperature operation:
 - When using the preload adjusting function, there should be no weight on the vehicle.
 - When using the preload adjusting function at ambient temperatures near or below 0 °C (32 °F), the suspension system warning light may come on.

Instrument and control functions

- The suspension will still operate as normal, only the preload adjusting function cannot be used.
- To reset the suspension system warning light, wait approximately 6 minutes and then turn the main switch off or immediately turn the main switch off and then wait 6 minutes.
- If the suspension system warning light remains on, have a Yamaha dealer check the vehicle.

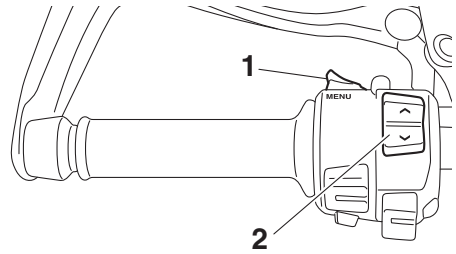

1. Menu switch "MENU"
2. Select switch " ^ / v "

3. Use the select switch to select the desired preload setting pictogram. Select the suitable setting from the following 4 pictograms according to your load condition.

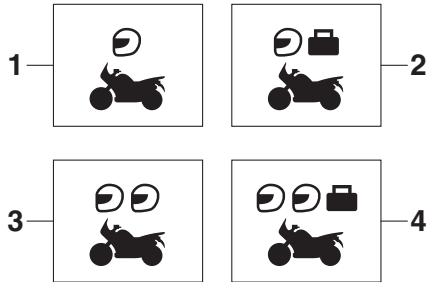

1. Solo riding
2. Solo riding and luggage
3. Passenger riding
4. Passenger riding and luggage

To adjust the preload

1. Turn the main switch on, start the engine, and then shift the transmission into neutral.
2. Push the menu switch to switch the function display to the preload adjusting function.

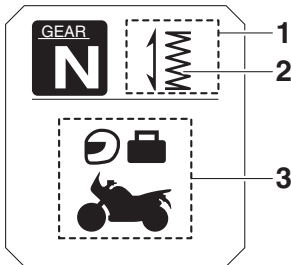

1. Function display
2. Preload adjusting function
3. Preload setting pictogram

While the preload is being adjusted, the information display will show a group of dots moving in a circle. Once the selected pictogram returns, the preload adjustment is complete.

Instrument and control functions

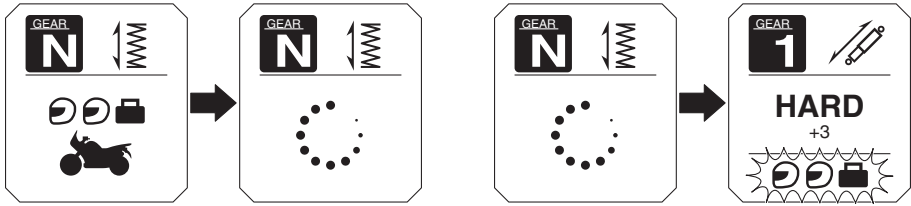

While the preload is being adjusted, the information display may change as follows.

- If the main switch is turned off or the engine is stopped while the preload is being set, the following preload setting pictogram will flash to alert you that the current preload setting does not match the pictogram. If this occurs, adjust the preload again.

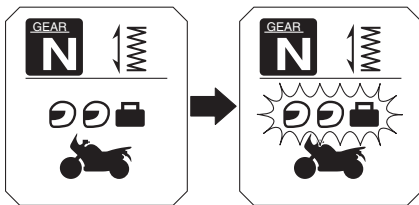

- If the vehicle starts moving, the following preload setting pictogram will flash to alert you that the current preload setting does not match the pictogram. If this occurs, stop the vehicle and adjust the preload again.

- If the preload is adjusted repeatedly, the preload setting pictogram will flash 4 times and the preload cannot be adjusted. Wait approximately 6 minutes for the preload adjusting function motor to cool down, and then try adjusting the preload again.

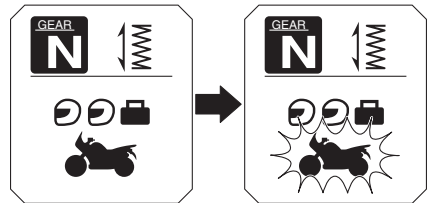

Damping force

Within each preload setting there are 3 damping force settings: “HARD” (hard), “STD” (standard) and “SOFT” (soft). When the preload setting is changed, the damping force settings will change accordingly. (The electronically adjustable suspension system will automatically adjust to the damping force settings last set for that preload setting.) To further finely adjust the damping force, each damping force setting can be set to 7 different levels.

Instrument and control functions

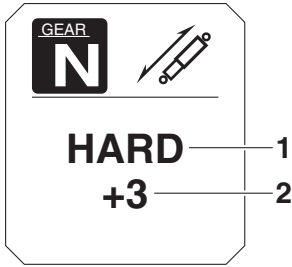

1. Damping force setting
2. Damping force setting level

TIP

If the preload setting was not completed correctly:

- The damping force setting and setting level will flash 4 times and cannot be adjusted if you try to adjust them while the vehicle is stopped.
- The preload setting pictogram will flash and the damping force cannot be adjusted if you try to adjust it while the vehicle is moving.

Be sure that the preload has been set correctly before adjusting the damping force.

To adjust the damping force and damping force setting level

1. Turn the main switch on.
2. Push the menu switch to switch the function display to the damping force adjusting function.

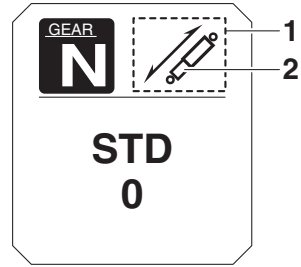

1. Function display
2. Damping force adjusting function
3. Use the select switch to select "HARD", "STD" or "SOFT".

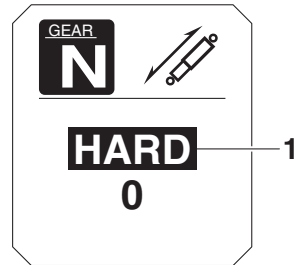

1. Damping force setting
4. Push the menu switch.
5. Use the select switch to select the desired level for the damping force setting.

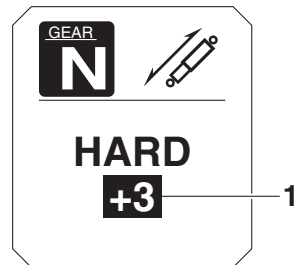

1. Damping force setting level

Instrument and control functions

TIP

The damping force setting can be set to 7 levels (+3, +2, +1, 0, -1, -2 and -3). “+3” is the hardest level and “-3” is the softest level.

6. Push the menu switch.

If the vehicle moves while you are adjusting the damping force, the information display will change to the display mode.

- Do not deform or damage the cylinder in any way. Cylinder damage will result in poor damping performance.
- Do not dispose of a damaged or worn-out shock absorber assembly yourself. Take the shock absorber assembly to a Yamaha dealer for any service.

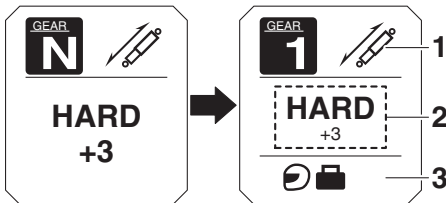

1. Damping force adjusting function
2. Damping force setting
3. Preload setting pictogram

EWA16421

WARNING

The rear shock absorber assembly contains highly pressurized nitrogen gas. Read and understand the following information before handling the shock absorber assembly.

- Do not tamper with or attempt to open the cylinder assembly.
- Do not subject the shock absorber assembly to an open flame or other high heat source. This may cause the unit to explode due to excessive gas pressure.

Instrument and control functions

EAU49705

Carriers

This motorcycle is equipped with a standard carrier, and with an additional carrier located under the passenger seat. This additional carrier extends the loading surface and the loading capacity of the standard carrier.

To use the additional carrier, consult a Yamaha dealer.

- Do not exceed the standard carrier capacity of 5.0 kg (11 lb).
- Do not exceed the additional carrier capacity of 5.0 kg (11 lb).

ECA16822

NOTICE

Do not lift the vehicle by either carrier.

3

Standard carrier

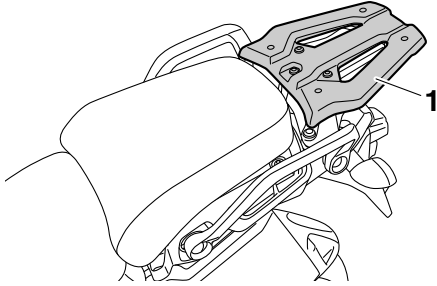

1. Standard carrier

Additional carrier

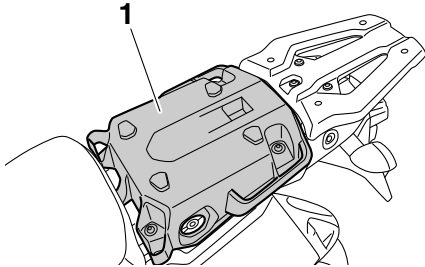

1. Additional carrier

EWA15484

⚠ WARNING

- Do not exceed the maximum load of 204 kg (450 lb) for the vehicle.
- Do not sit on and never ride with a passenger on the standard or additional carrier.

Luggage strap holders

EAU84680

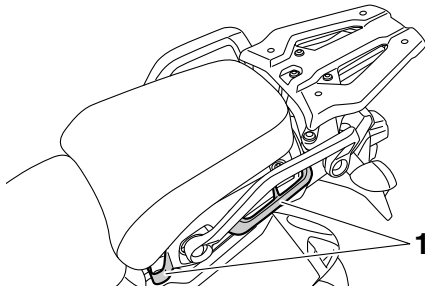

1. Luggage strap holder

Use the indicated strap points to secure luggage ties to the vehicle.

Auxiliary DC jack

EAU49454

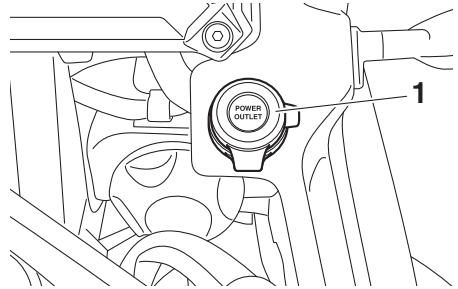

1. Auxiliary DC jack cap

A 12-V accessory connected to the auxiliary DC jack can be used when the main switch is on.

ECA15432

NOTICE

The accessory connected to the auxiliary DC jack should not be used with the engine turned off, and the load must never exceed 30 W (2.5 A), otherwise the fuse may blow or the battery may discharge.

To use the auxiliary DC jack

1. Turn the main switch off.
2. Remove the auxiliary DC jack cap.
3. Turn the accessory off.
4. Insert the accessory plug into the auxiliary DC jack.

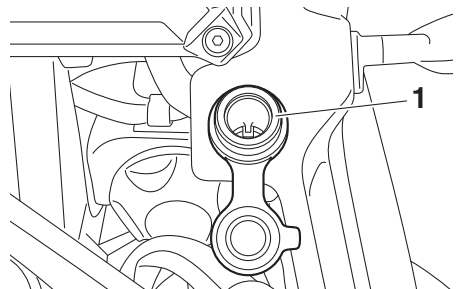

1. Auxiliary DC jack

Instrument and control functions

EAU15306

5. Turn the main switch on, and start the engine. (See page 5-2.)
6. Turn the accessory on.

EWA14361

WARNING

To prevent electrical shock or short-circuiting, make sure that the cap is installed when the auxiliary DC jack is not being used.

3

Sidestand

The sidestand is located on the left side of the frame. Raise the sidestand or lower it with your foot while holding the vehicle upright.

TIP

The built-in sidestand switch is part of the ignition circuit cut-off system, which cuts the ignition in certain situations. (See the following section for an explanation of the ignition circuit cut-off system.)

EWA10242

WARNING

The vehicle must not be ridden with the sidestand down, or if the sidestand cannot be properly moved up (or does not stay up), otherwise the sidestand could contact the ground and distract the operator, resulting in a possible loss of control. Yamaha's ignition circuit cut-off system has been designed to assist the operator in fulfilling the responsibility of raising the sidestand before starting off. Therefore, check this system regularly and have a Yamaha dealer repair it if it does not function properly.

EAU63431

Ignition circuit cut-off system

This system prevents in-gear engine starts unless the clutch lever is pulled and the sidestand is up. Also, it will stop the running engine should the sidestand be lowered while the transmission is in gear.

Periodically check the system via the following procedure.

TIP

- This check is most reliable if performed with a warmed-up engine.
 - See pages 3-2 and 3-22 for switch operation information.
-

Instrument and control functions

With the engine turned off:

1. Place vehicle on centerstand.
2. Move the sidestand down.
3. Set engine stop switch to run position.
4. Turn main switch to on position.
5. Shift transmission into neutral.
6. Push the start switch.

Does the engine start?

YES

NO



If a malfunction is found, have the vehicle inspected before riding.

The neutral switch may not be working.
The motorcycle should not be ridden until checked by a Yamaha dealer.

With the engine still running:

7. Move the sidestand up.
8. Pull the clutch lever.
9. Shift transmission into gear.
10. Move the sidestand down.

Does the engine stall?

YES

NO

The sidestand switch may not be working.
The motorcycle should not be ridden until checked by a Yamaha dealer.

After the engine has stalled:

11. Move the sidestand up.
12. Pull the clutch lever.
13. Push the start switch.

Does the engine start?

YES

NO

The clutch switch may not be working.
The motorcycle should not be ridden until checked by a Yamaha dealer.

The system is OK. **The motorcycle can be ridden.**

3

For your safety – pre-operation checks

EAU63441

Inspect your vehicle each time you use it to make sure the vehicle is in safe operating condition. Always follow the inspection and maintenance procedures and schedules described in the Owner's Manual.

EWA11152

WARNING

Failure to inspect or maintain the vehicle properly increases the possibility of an accident or equipment damage. Do not operate the vehicle if you find any problem. If a problem cannot be corrected by the procedures provided in this manual, have the vehicle inspected by a Yamaha dealer.

Before using this vehicle, check the following points:

ITEM	CHECKS	PAGE
Fuel	<ul style="list-style-type: none">• Check fuel level in fuel tank.• Refuel if necessary.• Check fuel line for leakage.• Check fuel tank breather hose and overflow hose for obstructions, cracks or damage, and check hose connections.	3-29, 3-31
Engine oil	<ul style="list-style-type: none">• Check oil level in engine.• If necessary, add recommended oil to specified level.• Check vehicle for oil leakage.	6-10
Final gear oil	<ul style="list-style-type: none">• Check vehicle for oil leakage.	6-14
Coolant	<ul style="list-style-type: none">• Check coolant level in reservoir.• If necessary, add recommended coolant to specified level.• Check cooling system for leakage.	6-16
Front brake	<ul style="list-style-type: none">• Check operation.• If soft or spongy, have Yamaha dealer bleed hydraulic system.• Check brake pads for wear.• Replace if necessary.• Check fluid level in reservoir.• If necessary, add specified brake fluid to specified level.• Check hydraulic system for leakage.	6-24, 6-25
Rear brake	<ul style="list-style-type: none">• Check operation.• If soft or spongy, have Yamaha dealer bleed hydraulic system.• Check brake pads for wear.• Replace if necessary.• Check fluid level in reservoir.• If necessary, add specified brake fluid to specified level.• Check hydraulic system for leakage.	6-24, 6-25
Clutch	<ul style="list-style-type: none">• Check operation.• If soft or spongy, have Yamaha dealer bleed hydraulic system.• Check hydraulic system for leakage.	6-22

For your safety – pre-operation checks

ITEM	CHECKS	PAGE
Throttle grip	<ul style="list-style-type: none"> • Make sure that operation is smooth. • Check throttle grip free play. • If necessary, have Yamaha dealer adjust throttle grip free play and lubricate cable and grip housing. 	6-18, 6-26
Wheels and tires	<ul style="list-style-type: none"> • Check for damage. • Check tire condition and tread depth. • Check air pressure. • Correct if necessary. 	6-19, 6-22
Brake and shift pedals	<ul style="list-style-type: none"> • Make sure that operation is smooth. • Lubricate pedal pivoting points if necessary. 	6-27
Brake and clutch levers	<ul style="list-style-type: none"> • Make sure that operation is smooth. • Lubricate lever pivoting points if necessary. 	6-27
Centerstand, side-stand	<ul style="list-style-type: none"> • Make sure that operation is smooth. • Lubricate pivots if necessary. 	6-28
Chassis fasteners	<ul style="list-style-type: none"> • Make sure that all nuts, bolts and screws are properly tightened. • Tighten if necessary. 	—
Instruments, lights, signals and switches	<ul style="list-style-type: none"> • Check operation. • Correct if necessary. 	—
Sidestand switch	<ul style="list-style-type: none"> • Check operation of ignition circuit cut-off system. • If system is not working correctly, have Yamaha dealer check vehicle. 	3-42

Operation and important riding points

EAU15952

EAU73451

Read the Owner's Manual carefully to become familiar with all controls. If there is a control or function you do not understand, ask your Yamaha dealer.

EWA10272

WARNING

Failure to familiarize yourself with the controls can lead to loss of control, which could cause an accident or injury.

TIP

This model is equipped with:

- a lean angle sensor to stop the engine in case of turnover. Turn the main switch off once before attempting to restart the engine. Failing to do so will prevent the engine from starting, even though the engine will crank when the start switch is pushed.
 - an engine auto-stop system. The engine stops automatically if left idling for 20 minutes. In this case, simply push the start switch to restart the engine.
-

Operation and important riding points

EAU58242

ECA17682

Starting the engine

In order for the ignition circuit cut-off system to enable starting, one of the following conditions must be met:

- The transmission is in the neutral position.
- The transmission is in gear with the clutch lever pulled and the sidestand up.

See page 3-43 for more information.

1. Turn the key to “ON” and make sure that the start/engine stop switch is set to “○”.

The following warning lights and indicator lights should come on for a few seconds, then go off.

- Oil level warning light
- Engine trouble warning light
- Traction control system indicator light
- Cruise control indicator lights
- Suspension system warning light
- Immobilizer system indicator light

ECA11834

NOTICE

If a warning or indicator light does not come on initially when the key is turned to “ON”, or if a warning or indicator light remains on, see page 3-3 for the corresponding warning and indicator light circuit check.

The ABS warning light should come on when the key is turned to “ON”, and then go off after traveling at a speed of 10 km/h (6 mi/h) or higher.

NOTICE

If the ABS warning light does not come on and then go off as explained above, see page 3-3 for the warning light circuit check.

2. Shift the transmission into the neutral position. The neutral indicator light should come on. If not, ask a Yamaha dealer to check the electrical circuit.
3. Start the engine by pushing the “⊕” side of the start/engine stop switch.

If the engine fails to start, release the start/engine stop switch, wait a few seconds, and then try again. Each starting attempt should be as short as possible to preserve the battery. Do not crank the engine more than 10 seconds on any one attempt.

ECA11043

NOTICE

For maximum engine life, never accelerate hard when the engine is cold!

Operation and important riding points

Shifting

EAU16674

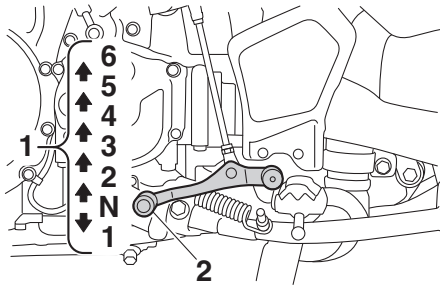

1. Gear positions
2. Shift pedal

Shifting gears lets you control the amount of engine power available for starting off, accelerating, climbing hills, etc.

The gear positions are shown in the illustration.

TIP

To shift the transmission into the neutral position (**N**), press the shift pedal down repeatedly until it reaches the end of its travel, and then slightly raise it.

ECA10261

NOTICE

- **Even with the transmission in the neutral position, do not coast for long periods of time with the engine off, and do not tow the motorcycle for long distances. The transmission is properly lubricated only when the engine is running. Inadequate lubrication may damage the transmission.**
- **Always use the clutch while changing gears to avoid damaging the engine, transmission,**

and drive train, which are not designed to withstand the shock of forced shifting.

EAU85370

To start out and accelerate

1. Pull the clutch lever to disengage the clutch.
2. Shift the transmission into first gear. The neutral indicator light should go out.
3. Open the throttle gradually, and at the same time, release the clutch lever slowly.
4. After starting out, close the throttle, and at the same time, quickly pull the clutch lever in.
5. Shift the transmission into second gear. (Make sure not to shift the transmission into the neutral position.)
6. Open the throttle part way and gradually release the clutch lever.
7. Follow the same procedure when shifting to the next higher gear.

EAU85380

To decelerate

1. Release the throttle and apply both the front and the rear brakes smoothly to slow the motorcycle.
2. As the vehicle decelerates, shift to a lower gear.
3. When the engine is about to stall or runs roughly, pull the clutch lever in, use the brakes to slow the motorcycle, and continue to downshift as necessary.
4. Once the motorcycle has stopped, the transmission can be shifted into the neutral position.

Operation and important riding points

The neutral indicator light should come on and then the clutch lever can be released.

EWA17380

EAU16811

WARNING

- **Improper braking can cause loss of control or traction. Always use both brakes and apply them smoothly.**
 - **Make sure that the motorcycle and the engine have sufficiently slowed before shifting to a lower gear. Engaging a lower gear when the vehicle or engine speed is too high could make the rear wheel lose traction or the engine to over-rev. This could cause loss of control, an accident and injury. It could also cause engine or drive train damage.**
-

Tips for reducing fuel consumption

Fuel consumption depends largely on your riding style. Consider the following tips to reduce fuel consumption:

- Shift up swiftly, and avoid high engine speeds during acceleration.
- Do not rev the engine while shifting down, and avoid high engine speeds with no load on the engine.
- Turn the engine off instead of letting it idle for an extended length of time (e.g., in traffic jams, at traffic lights or at railroad crossings).

Operation and important riding points

EAU16842

Engine break-in

There is never a more important period in the life of your engine than the period between 0 and 1600 km (1000 mi). For this reason, you should read the following material carefully.

Since the engine is brand new, do not put an excessive load on it for the first 1600 km (1000 mi). The various parts in the engine wear and polish themselves to the correct operating clearances. During this period, prolonged full-throttle operation or any condition that might result in engine overheating must be avoided.

- If any engine trouble should occur during the engine break-in period, immediately have a Yamaha dealer check the vehicle.
-

EAU58991

0–1000 km (0–600 mi)

Avoid prolonged operation above 3900 r/min. **NOTICE: After 1000 km (600 mi) of operation, the engine oil and final gear oil must be changed, and the oil filter cartridge or element replaced.**^[ECA10333]

1000–1600 km (600–1000 mi)

Avoid prolonged operation above 4700 r/min.

1600 km (1000 mi) and beyond

The vehicle can now be operated normally.

ECA23060

NOTICE

- Keep the engine speed out of the tachometer high-r/min zone.

Operation and important riding points

EAU17214

Parking

When parking, stop the engine, and then remove the key from the main switch.

EWA10312

WARNING

- Since the engine and exhaust system can become very hot, park in a place where pedestrians or children are not likely to touch them and be burned.
 - Do not park on a slope or on soft ground, otherwise the vehicle may overturn, increasing the risk of a fuel leak and fire.
 - Do not park near grass or other flammable materials which might catch fire.
-

Periodic maintenance and adjustment

EAU17246

Periodic inspection, adjustment, and lubrication will keep your vehicle in the safest and most efficient condition possible. Safety is an obligation of the vehicle owner/operator. The most important points of vehicle inspection, adjustment, and lubrication are explained on the following pages.

The intervals given in the periodic maintenance charts should be simply considered as a general guide under normal riding conditions. However, depending on the weather, terrain, geographical location, and individual use, the maintenance intervals may need to be shortened.

EWA10322

WARNING

Failure to properly maintain the vehicle or performing maintenance activities incorrectly may increase your risk of injury or death during service or while using the vehicle. If you are not familiar with vehicle service, have a Yamaha dealer perform service.

EWA15123

WARNING

Turn off the engine when performing maintenance unless otherwise specified.

- **A running engine has moving parts that can catch on body parts or clothing and electrical parts that can cause shocks or fires.**
- **Running the engine while servicing can lead to eye injury, burns, fire, or carbon monoxide poisoning – possibly leading to**

death. See page 1-3 for more information about carbon monoxide.

EWA15461

WARNING

Brake discs, calipers, drums, and linings can become very hot during use. To avoid possible burns, let brake components cool before touching them.

Periodic maintenance and adjustment

EAU17303

EAU85230

Emission controls not only function to ensure cleaner air, but are also vital to proper engine operation and maximum performance. In the following periodic maintenance charts, the services related to emissions control are grouped separately. These services require specialized data, knowledge, and equipment. Maintenance, replacement, or repair of the emission control devices and systems may be performed by any repair establishment or individual that is certified (if applicable). Yamaha dealers are trained and equipped to perform these particular services.

Tool kit

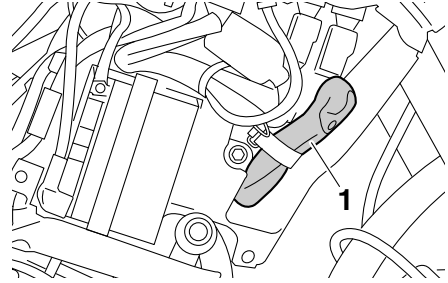

1. Tool kit

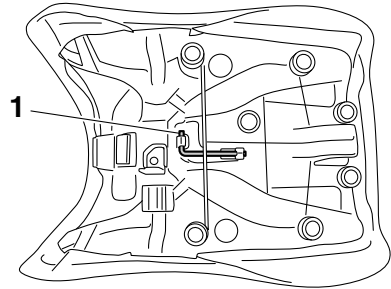

1. Hexagon wrench

The tool kit is in the location shown. The information included in this manual and the tools provided in the tool kit are intended to assist you in the performance of preventive maintenance and minor repairs. However, a torque wrench and other tools are necessary to perform certain maintenance work correctly.

TIP

If you do not have the tools or experience required for a particular job, have your Yamaha dealer perform it for you.

Periodic maintenance and adjustment

EAU71033

Periodic maintenance charts

TIP

- Items marked with an asterisk should be performed by your Yamaha dealer because these items require special tools, data, and technical skills.
- From 50000 km (30000 mi), repeat the maintenance intervals starting from 10000 km (6000 mi).
- **The annual checks must be performed every year, except if a distance-based maintenance is performed instead.**

EAU71071

Periodic maintenance chart for the emission control system

NO.	ITEM	CHECK OR MAINTENANCE JOB	ODOMETER READINGS					ANNUAL CHECK		
			X 1000 km							
			1	10	20	30	40			
X 1000 mi					0.6	6	12	18	24	
1	*	Fuel line	<ul style="list-style-type: none"> ● Check fuel hoses for cracks or damage. ● Replace if necessary. 		√	√	√	√	√	√
2	*	Spark plugs	<ul style="list-style-type: none"> ● Check condition. ● Adjust gap and clean. 		√		√			
			<ul style="list-style-type: none"> ● Replace. 			√		√		
3	*	Valve clearance	<ul style="list-style-type: none"> ● Check and adjust. 	Every 40000 km (24000 mi)						
4	*	Fuel injection	<ul style="list-style-type: none"> ● Check engine idle speed. 	√	√	√	√	√	√	√
			<ul style="list-style-type: none"> ● Check and adjust synchronization. 		√	√	√	√	√	
5	*	Exhaust system	<ul style="list-style-type: none"> ● Check for leakage. ● Tighten if necessary. ● Replace gaskets if necessary. 	√	√	√	√	√		
6	*	Evaporative emission control system	<ul style="list-style-type: none"> ● Check control system for damage. ● Replace if necessary. 			√		√		

Periodic maintenance and adjustment

EAU71372

General maintenance and lubrication chart

NO.	ITEM	CHECK OR MAINTENANCE JOB	ODOMETER READINGS					ANNUAL CHECK		
			X 1000 km							
			1	10	20	30	40			
X 1000 mi					0.6	6	12	18	24	
1	* Diagnostic system check	<ul style="list-style-type: none"> Perform dynamic inspection using Yamaha diagnostic tool. Check the error codes. 	√	√	√	√	√	√	√	√
2	* Air filter element	<ul style="list-style-type: none"> Replace. 	Every 40000 km (24000 mi)							
3	* Clutch	<ul style="list-style-type: none"> Check operation, fluid level and vehicle for fluid leakage. 	√	√	√	√	√	√		
4	* Front brake	<ul style="list-style-type: none"> Check operation, fluid level, and for fluid leakage. Replace brake pads if necessary. 	√	√	√	√	√	√	√	
5	* Rear brake	<ul style="list-style-type: none"> Check operation, fluid level, and for fluid leakage. Replace brake pads if necessary. 	√	√	√	√	√	√	√	
6	* Brake hoses	<ul style="list-style-type: none"> Check for cracks or damage. 		√	√	√	√	√	√	
		<ul style="list-style-type: none"> Replace. 	Every 4 years							
7	* Brake fluid	<ul style="list-style-type: none"> Change. 	Every 2 years							
8	* Wheels	<ul style="list-style-type: none"> Check runout and for damage. Tighten all spokes. 	At the initial interval and every 5000 km (3000 mi) thereafter							
9	* Tires	<ul style="list-style-type: none"> Check tread depth and for damage. Replace if necessary. Check air pressure. Correct if necessary. 		√	√	√	√	√	√	
10	* Wheel bearings	<ul style="list-style-type: none"> Check bearing for looseness or damage. 		√	√	√	√	√		
11	* Swingarm pivot bearings	<ul style="list-style-type: none"> Check operation and for excessive play. 		√	√	√	√	√		
		<ul style="list-style-type: none"> Lubricate with lithium-soap-based grease. 	Every 50000 km (30000 mi)							
12	* Steering bearings	<ul style="list-style-type: none"> Check bearing assemblies for looseness. 	√	√	√	√	√			
		<ul style="list-style-type: none"> Moderately repack with lithium-soap-based grease. 	Every 50000 km (30000 mi)							

Periodic maintenance and adjustment

NO.	ITEM	CHECK OR MAINTENANCE JOB	ODOMETER READINGS					ANNUAL CHECK		
			X 1000 km							
			1	10	20	30	40			
X 1000 mi					0.6	6	12	18	24	
13	* Chassis fasteners	<ul style="list-style-type: none"> Make sure that all nuts, bolts and screws are properly tightened. 		√	√	√	√	√	√	√
14	Brake lever pivot shaft	<ul style="list-style-type: none"> Lubricate with silicone grease. 		√	√	√	√	√	√	√
15	Brake pedal pivot shaft	<ul style="list-style-type: none"> Lubricate with lithium-soap-based grease. 		√	√	√	√	√	√	√
16	Clutch lever pivot shaft	<ul style="list-style-type: none"> Lubricate with silicone grease. 		√	√	√	√	√	√	√
17	Shift pedal pivot shaft	<ul style="list-style-type: none"> Lubricate with lithium-soap-based grease. 		√	√	√	√	√	√	√
18	Sidestand, center-stand	<ul style="list-style-type: none"> Check operation. Lubricate with lithium-soap-based grease. 		√	√	√	√	√	√	√
19	* Sidestand switch	<ul style="list-style-type: none"> Check operation and replace if necessary. 	√	√	√	√	√	√	√	√
20	* Front fork	<ul style="list-style-type: none"> Check operation and for oil leakage. Replace if necessary. 		√	√	√	√	√	√	√
21	* Shock absorber assembly	<ul style="list-style-type: none"> Check operation and for oil leakage. Replace if necessary. 		√	√	√	√	√	√	√
22	* Rear suspension relay arm and connecting arm pivoting points	<ul style="list-style-type: none"> Check operation. 		√	√	√	√	√	√	√
23	Engine oil	<ul style="list-style-type: none"> Change (warm engine before draining). Check oil level and vehicle for oil leakage. 	√	√	√	√	√	√	√	√
24	Engine oil filter cartridge	<ul style="list-style-type: none"> Replace. 	√		√		√		√	
25	* Cooling system	<ul style="list-style-type: none"> Check coolant level and vehicle for coolant leakage. Change. 		√	√	√	√	√	√	√
			Every 3 years							

Periodic maintenance and adjustment

NO.	ITEM	CHECK OR MAINTENANCE JOB	ODOMETER READINGS					ANNUAL CHECK		
			X 1000 km							
			1	10	20	30	40			
X 1000 mi					0.6	6	12	18	24	
26	* Final gear oil	• Check oil level and vehicle for oil leakage.	√	√	√	√	√			
		• Change.	√		√		√			
27	* Front and rear brake switches	• Check operation.	√	√	√	√	√	√		
28	* Moving parts and cables	• Lubricate.		√	√	√	√	√		
29	* Throttle grip housing and cable	• Check operation and free play. • Adjust the throttle cable free play if necessary. • Lubricate the throttle grip housing, cable and grip warmer wire.		√	√	√	√	√		
30	* Lights, signals and switches	• Check operation. • Adjust headlight beam.	√	√	√	√	√	√		

EAU72841

TIP

Air filter

- This model's air filter uses a disposable oil-coated paper element, which must be replaced. Do not clean with compressed air, doing so will only damage it.
- The air filter element needs to be replaced more frequently if you often ride in the rain or dusty areas.

Hydraulic brake and clutch service

- Regularly check the brake fluid and clutch fluid reservoirs. Replenish as necessary.
- Every two years replace the internal components of the brake master cylinders and calipers as well as clutch master and release cylinders, and change the brake and clutch fluids.
- Replace the brake and clutch hoses every four years or sooner if cracked or damaged.

Periodic maintenance and adjustment

EAU18782

Removing and installing cowlings

The cowlings shown need to be removed to perform some of the maintenance jobs described in this chapter. Refer to this section each time a cowling needs to be removed and installed.

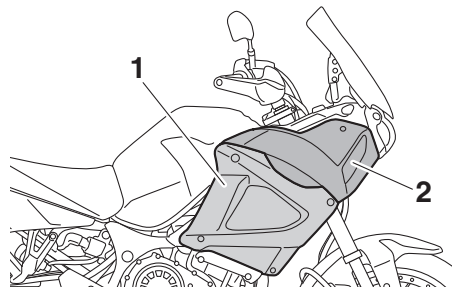

1. Cowling A
2. Cowling B

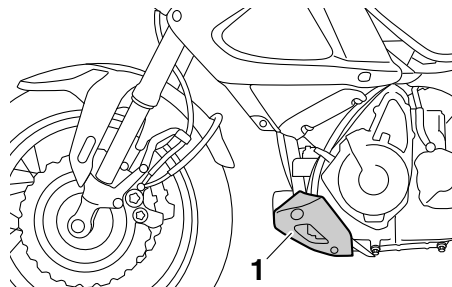

1. Cowling C

EAU55960

Cowling A

To remove the cowling

Remove the quick fastener screws, and then pull the cowling off as shown.

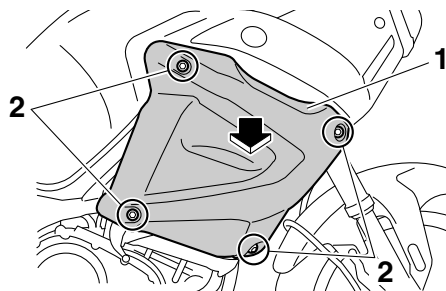

1. Cowling A
2. Quick fastener screw

To install the cowling

1. Fit the projections on the cowling into the matching holes in cowling B.

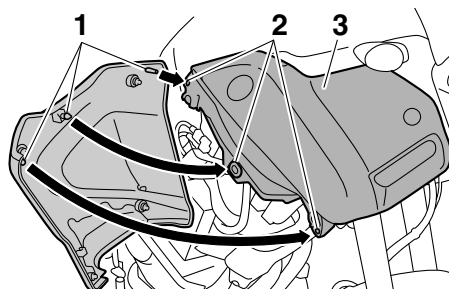

1. Projection
2. Matching hole
3. Cowling B

2. Install the quick fastener screws.

Cowling B

To remove the cowling

1. Remove cowling A.
2. Remove the bolts and the quick fasteners, and then pull the cowling off.

Periodic maintenance and adjustment

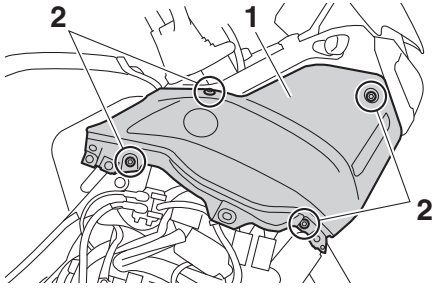

1. Cowling B
2. Bolt

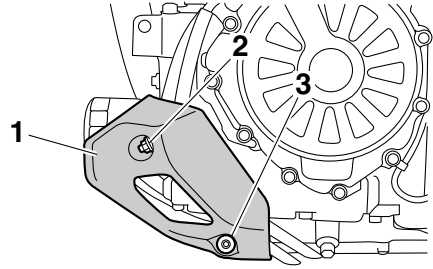

1. Cowling C
2. Nut
3. Bolt

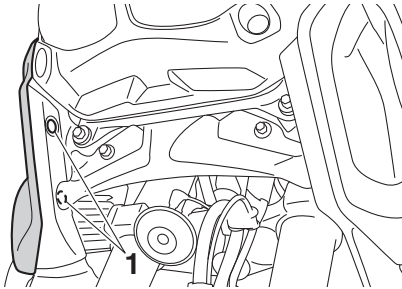

1. Quick fastener

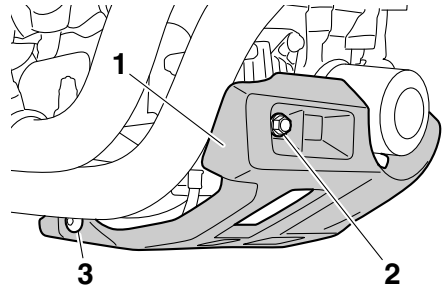

1. Cowling C
2. Nut
3. Bolt

To install the cowling

1. Place the cowling in the original position, and then install the bolts and the quick fasteners.
2. Install cowling A.

Cowling C

To remove the cowling

Remove the bolts and the nuts, and then take the cowling off.

To install the cowling

Place the cowling in the original position, and then install the bolts and the nuts.

Periodic maintenance and adjustment

EAU19653

Checking the spark plugs

The spark plugs are important engine components, which should be checked periodically, preferably by a Yamaha dealer. Since heat and deposits will cause any spark plug to slowly erode, they should be removed and checked in accordance with the periodic maintenance and lubrication chart. In addition, the condition of the spark plugs can reveal the condition of the engine.

The porcelain insulator around the center electrode of each spark plug should be a medium-to-light tan (the ideal color when the vehicle is ridden normally), and all spark plugs installed in the engine should have the same color. If any spark plug shows a distinctly different color, the engine could be operating improperly. Do not attempt to diagnose such problems yourself. Instead, have a Yamaha dealer check the vehicle.

If a spark plug shows signs of electrode erosion and excessive carbon or other deposits, it should be replaced.

Specified spark plug:
NGK/CPR8EB9

Before installing a spark plug, the spark plug gap should be measured with a wire thickness gauge and, if necessary, adjusted to specification.

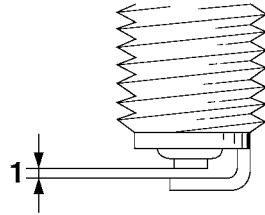

1. Spark plug gap

Spark plug gap:
0.8–0.9 mm (0.031–0.035 in)

Clean the surface of the spark plug gasket and its mating surface, and then wipe off any grime from the spark plug threads.

Tightening torque:
Spark plug:
13 N·m (1.3 kgf·m, 9.6 lb·ft)

TIP _____
If a torque wrench is not available when installing a spark plug, a good estimate of the correct torque is 1/4–1/2 turn past finger tight. However, the spark plug should be tightened to the specified torque as soon as possible.

ECA10841

NOTICE _____
Do not use any tools to remove or install the spark plug cap, otherwise the ignition coil coupler may get damaged. The spark plug cap may be difficult to remove because the rubber seal on the end of the cap fits tightly. To remove the spark plug cap, simply twist it back and forth while pulling it out; to install it, twist it back and forth while pushing it in.

Periodic maintenance and adjustment

EAU79401

EAU49508

Canister

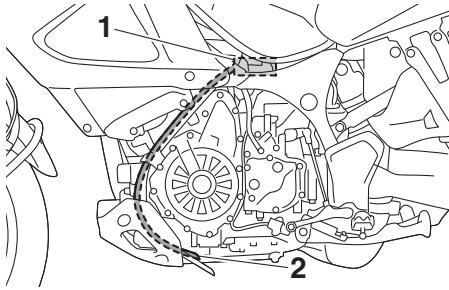

1. Canister
2. Canister breather hose

This model is equipped with a canister to prevent the discharging of fuel vapor into the atmosphere. Before operating this vehicle, make sure to check the following:

- Check each hose connection.
- Check each hose and canister for cracks or damage. Replace if damaged.
- Make sure that the canister breather hose is not blocked, and if necessary, clean it.
- Make sure that the canister breather hose is positioned outside of the cowling.

Engine oil

The engine oil level should be checked regularly. In addition, the oil must be changed and the oil filter cartridge replaced at the intervals specified in the periodic maintenance chart.

Recommended engine oil:

See page 8-1.

Oil quantity:

Oil change:

3.10 L (3.28 US qt, 2.73 Imp.qt)

With oil filter removal:

3.40 L (3.59 US qt, 2.99 Imp.qt)

ECA11621

NOTICE

- **In order to prevent clutch slippage (since the engine oil also lubricates the clutch), do not mix any chemical additives. Do not use oils with a diesel specification of “CD” or oils of a higher quality than specified. In addition, do not use oils labeled “ENERGY CONSERVING II” or higher.**
- **Make sure that no foreign material enters the crankcase.**

To check the engine oil level

1. Place the vehicle on the center-stand. A slight tilt to the side can result in a false reading.
2. Start the engine and warm it up for ten minutes until the engine oil has reached a normal temperature of 60 °C (140 °F), and then turn the engine off.
3. Wait a few minutes for the oil level to settle for an accurate reading, and then check the oil level

Periodic maintenance and adjustment

through the engine oil level check window located at the bottom-right side of the crankcase.

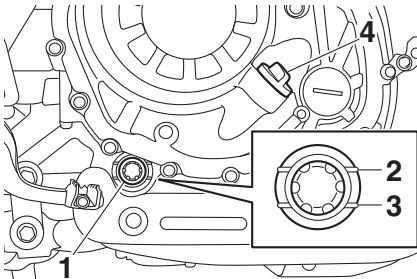

1. Engine oil level check window
2. Maximum level mark
3. Minimum level mark
4. Engine oil filler cap

TIP

The engine oil should be between the minimum and maximum level marks.

4. If the engine oil is at or below the minimum level mark, remove the oil filler cap and add oil.
5. Check the engine oil filler cap O-ring. Replace if damaged.

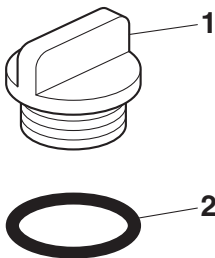

1. Engine oil filler cap
2. O-ring

6. Install the engine oil filler cap.

To change the engine oil (and filter)

1. Start the engine and allow it to idle for a few minutes to warm up the oil, and then stop the engine.
2. Place an oil pan under the oil tank to collect the used oil.
3. Remove the engine oil filler cap, the drain bolt and its gasket to drain the oil from the oil tank.

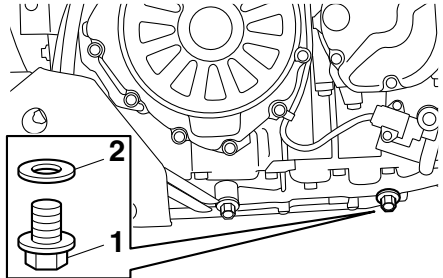

1. Engine oil drain bolt (oil tank)
2. Gasket

4. Place an oil pan under the engine to collect the used oil.
5. Remove the engine oil drain bolt and its gasket to drain the oil from the crankcase.

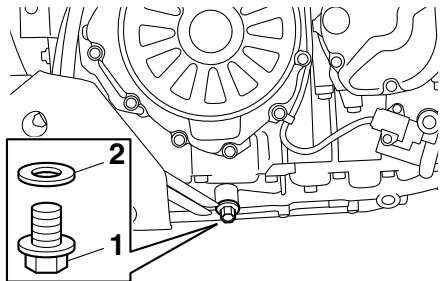

1. Engine oil drain bolt (crankcase)
2. Gasket

TIP

Skip steps 6–10 if the oil filter cartridge is not being replaced.

Periodic maintenance and adjustment

6. Remove cowling C. (See page 6-7.)
7. Remove the oil filter cartridge with an oil filter wrench.

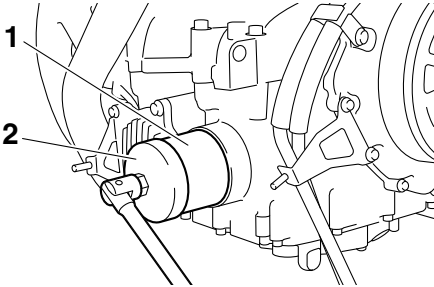

1. Oil filter cartridge
2. Oil filter wrench

TIP

An oil filter wrench is available at a Yamaha dealer.

8. Apply a thin coat of clean engine oil to the O-ring of the new oil filter cartridge.

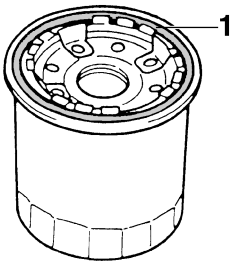

1. O-ring

TIP

Make sure that the O-ring is properly seated.

9. Install the new oil filter cartridge, and then tighten it to the specified torque.

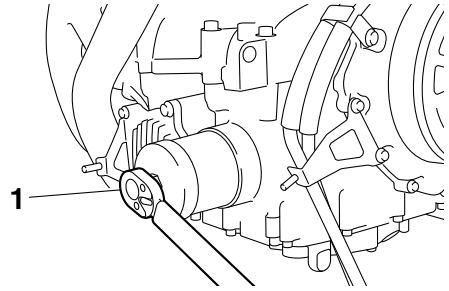

1. Torque wrench

Tightening torque:

Oil filter cartridge:
17 N·m (1.7 kgf·m, 13 lb·ft)

10. Install the cowling.
11. Install the engine oil drain bolts and their new gasket, and then tighten the bolts to the specified torques.

Tightening torques:

Engine oil drain bolt (crankcase):
20 N·m (2.0 kgf·m, 15 lb·ft)
Engine oil drain bolt (oil tank):
20 N·m (2.0 kgf·m, 15 lb·ft)

12. Refill with the specified amount of the recommended engine oil.

TIP

Using a funnel is recommended.

13. After checking the engine oil filler cap O-ring, install the filler cap.

TIP

Wipe off any spilled oil before starting the engine.

14. Start the engine and let it idle while checking for oil leaks.

TIP

If any oil leaks are found which you cannot fix, have the vehicle inspected.

Periodic maintenance and adjustment

EAU85450

15. Stop the engine, wait a few minutes for the oil level to settle, and then check the oil level one last time. **NOTICE: Do not operate the vehicle until you know that the engine oil level is sufficient.**

[ECA10012]

Why Yamalube

YAMALUBE oil is a Genuine YAMAHA Part born of the engineers' passion and belief that engine oil is an important liquid engine component. We form teams of specialists in the fields of mechanical engineering, chemistry, electronics and track testing, and have them develop the engine together with the oil it will use. Yamalube oils take full advantage of the base oil's qualities and blend in the ideal balance of additives to make sure the final oil clears our performance standards. Thus, Yamalube mineral, semisynthetic and synthetic oils have their own distinct characters and value. Yamaha's experience gained over many years of research and development into oil since the 1960's helps make Yamalube the best choice for your Yamaha engine.



YAMALUBE®

Periodic maintenance and adjustment

EAU20017

Final gear oil

The final gear case must be checked for oil leakage before each ride. If any leakage is found, have a Yamaha dealer check and repair the vehicle. In addition, the final gear oil level must be checked and the oil changed as follows at the intervals specified in the periodic maintenance and lubrication chart.

EWA10371

WARNING

- **Make sure that no foreign material enters the final gear case.**
- **Make sure that no oil gets on the tire or wheel.**

6

To check the final gear oil level

1. Place the vehicle on the center-stand.

TIP

Make sure that the vehicle is positioned straight up when checking the oil level. A slight tilt to the side can result in a false reading.

2. Remove the final gear oil filler bolt and its gasket, and then check the oil level in the final gear case.

TIP

The oil level should be at the brim of the filler hole.

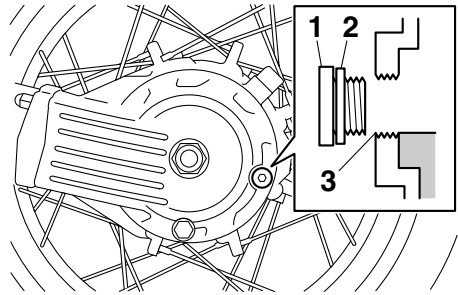

1. Final gear oil filler bolt
2. Gasket
3. Correct oil level

3. If the oil is below the brim of the filler hole, add sufficient oil of the recommended type to raise it to the correct level.
4. Check the gasket for damage, and replace it if necessary.
5. Install the final gear oil filler bolt and its gasket, and then tighten the bolt to the specified torque.

Tightening torque:

Final gear oil filler bolt:
23 N·m (2.3 kgf·m, 17 lb·ft)

To change the final gear oil

1. Place the vehicle on a level surface.
2. Place an oil pan under the final gear case to collect the used oil.
3. Remove the final gear oil filler bolt, the final gear oil drain bolt and their gasket to drain the oil from the final gear case.

Periodic maintenance and adjustment

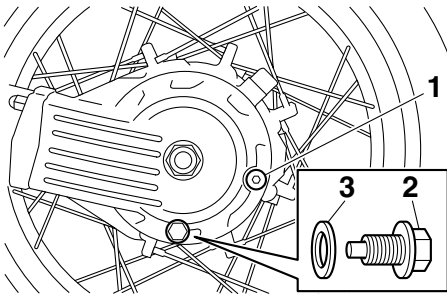

1. Final gear oil filler bolt
2. Final gear oil drain bolt
3. Gasket

4. Install the final gear oil drain bolt and its new gasket, and then tighten the bolt to the specified torque.

Tightening torque:

Final gear oil drain bolt:
23 N·m (2.3 kgf·m, 17 lb·ft)

5. Refill with the recommended final gear oil to the brim of the filler hole.

Recommended final gear oil:

Yamaha genuine shaft drive gear oil
SAE 80W-90 API GL-5 or SAE 80
API GL-4 Hypoid gear oil

Oil quantity:

0.20 L (0.21 US qt, 0.18 Imp.qt)

6. Check the oil filler bolt gasket for damage, and replace it if necessary.
7. Install the oil filler bolt and its gasket, and then tighten the bolt to the specified torque.

Tightening torque:

Final gear oil filler bolt:
23 N·m (2.3 kgf·m, 17 lb·ft)

8. Check the final gear case for oil leakage. If oil is leaking, check for the cause.

Periodic maintenance and adjustment

EAUS1203

Coolant

The coolant level should be checked regularly. In addition, the coolant must be changed at the intervals specified in the periodic maintenance chart.

Recommended coolant:

YAMALUBE coolant

Coolant quantity:

Coolant reservoir (max level mark):

0.26 L (0.27 US qt, 0.23 Imp.qt)

Radiator (including all routes):

1.83 L (1.93 US qt, 1.61 Imp.qt)

TIP

If genuine Yamaha coolant is not available, use an ethylene glycol antifreeze containing corrosion inhibitors for aluminum engines and mix with distilled water at a 1:1 ratio.

EAU20097

To check the coolant level

Since the coolant level varies with engine temperature, check when the engine is cold.

1. Park the vehicle on a level surface.
2. With the vehicle in an upright position, look at the coolant level in the reservoir.

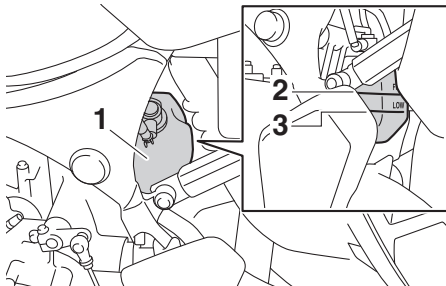

1. Coolant reservoir
2. Maximum level mark
3. Minimum level mark

3. If the coolant is at or below the minimum level mark, remove the coolant reservoir cap. **WARNING! Remove only the coolant reservoir cap. Never attempt to remove the radiator cap when the engine is hot.** [EWA15162]

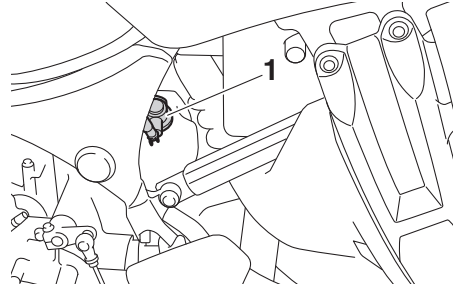

1. Coolant reservoir cap

4. Add coolant to the maximum level mark. **NOTICE: If coolant is not available, use distilled water or soft tap water instead. Do not use hard water or salt water since it is harmful to the engine. If water has been used instead of coolant, replace it with coolant as soon as possible, otherwise the cooling system will not be protected against frost and corrosion. If water has been added to the coolant, have a Yamaha dealer check the anti-freeze content of the coolant as soon as possible, otherwise the effectiveness of the coolant will be reduced.** [ECA10473]
5. Install the coolant reservoir cap.

EAU33032

Changing the coolant

The coolant must be changed at the intervals specified in the periodic maintenance and lubrication chart. Have a

Periodic maintenance and adjustment

Yamaha dealer change the coolant.
WARNING! Never attempt to remove the radiator cap when the engine is hot. [EWA10382]

EAU36765

Air filter element

The air filter element must be replaced at the intervals specified in the periodic maintenance and lubrication chart. Have a Yamaha dealer replace the air filter element.

Periodic maintenance and adjustment

Checking the engine idling speed

EAU44735

Check the engine idling speed and, if necessary, have it corrected by a Yamaha dealer.

Engine idling speed:
1050–1150 r/min

Checking the throttle grip free play

EAU21386

Measure the throttle grip free play as shown.

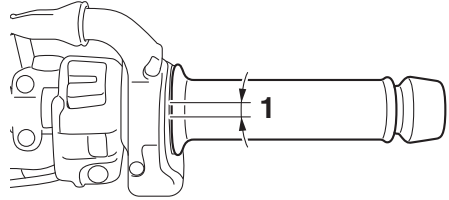

1. Throttle grip free play

Throttle grip free play:
3.0–5.0 mm (0.12–0.20 in)

Periodically check the throttle grip free play and, if necessary, have a Yamaha dealer adjust it.

Periodic maintenance and adjustment

EAU21403

EAU64412

Valve clearance

The valves are an important engine component, and since valve clearance changes with use, they must be checked and adjusted at the intervals specified in the periodic maintenance chart. Unadjusted valves can result in improper air-fuel mixture, engine noise, and eventually engine damage. To prevent this from occurring, have your Yamaha dealer check and adjust the valve clearance at regular intervals.

TIP

This service must be performed when the engine is cold.

Tires

Tires are the only contact between the vehicle and the road. Safety in all conditions of riding depends on a relatively small area of road contact. Therefore, it is essential to maintain the tires in good condition at all times and replace them at the appropriate time with the specified tires.

Tire air pressure

The tire air pressure should be checked and, if necessary, adjusted before each ride.

EWA10504



Operation of this vehicle with improper tire pressure may cause severe injury or death from loss of control.

- The tire air pressure must be checked and adjusted on cold tires (i.e., when the temperature of the tires equals the ambient temperature).
 - The tire air pressure must be adjusted in accordance with the riding speed and with the total weight of rider, passenger, cargo, and accessories approved for this model.
-

Periodic maintenance and adjustment

Cold tire air pressure:

1 person:

- Front:
225 kPa (2.25 kgf/cm², 33 psi)
Rear:
250 kPa (2.50 kgf/cm², 36 psi)

2 persons:

- Front:
225 kPa (2.25 kgf/cm², 33 psi)
Rear:
290 kPa (2.90 kgf/cm², 42 psi)

Maximum load:

- Vehicle:
204 kg (450 lb)
The vehicle's maximum load is the combined weight of the rider, passenger, cargo, and any accessories.

Minimum tire tread depth (front and rear):

1.6 mm (0.06 in)

TIP

The tire tread depth limits may differ from country to country. Always comply with the local regulations.

EWA10472

WARNING

- Have a Yamaha dealer replace excessively worn tires. Besides being illegal, operating the vehicle with excessively worn tires decreases riding stability and can lead to loss of control.
- The replacement of all wheel and brake-related parts, including the tires, should be left to a Yamaha dealer, who has the necessary professional knowledge and experience to do so.
- Ride at moderate speeds after changing a tire since the tire surface must first be "broken in" for it to develop its optimal characteristics.

EWA10512

WARNING

Never overload your vehicle. Operation of an overloaded vehicle could cause an accident.

6

Tire inspection

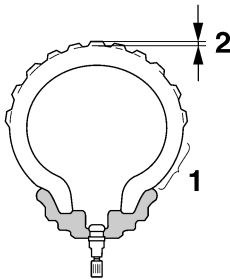

1. Tire sidewall
2. Tire tread depth

The tires must be checked before each ride. If the center tread depth reaches the specified limit, if the tire has a nail or glass fragments in it, or if the sidewall is cracked, have a Yamaha dealer replace the tire immediately.

Tire information

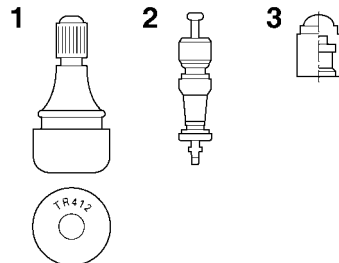

1. Tire air valve
2. Tire air valve core
3. Tire air valve cap with seal

Periodic maintenance and adjustment

EWA10601

This model is equipped with tubeless tires and tire air valves.

Tires age, even if they have not been used or have only been used occasionally. Cracking of the tread and sidewall rubber, sometimes accompanied by carcass deformation, is an evidence of ageing. Old and aged tires shall be checked by tire specialists to ascertain their suitability for further use.

EWA10902

WARNING

- **The front and rear tires should be of the same make and design, otherwise the handling characteristics of the motorcycle may be different, which could lead to an accident.**
- **Always make sure that the valve caps are securely installed to prevent air pressure leakage.**
- **Use only the tire valves and valve cores listed below to avoid tire deflation during a ride.**

After extensive tests, only the tires listed below have been approved for this model by Yamaha.

Front tire:

Size:

110/80R19M/C 59V

Manufacturer/model:

BRIDGESTONE/BW501

Rear tire:

Size:

150/70R17M/C 69V

Manufacturer/model:

BRIDGESTONE/BW502

FRONT and REAR:

Tire air valve:

TR412

Valve core:

#9100 (original)

WARNING

This motorcycle is fitted with super-high-speed tires. Note the following points in order to make the most efficient use of these tires.

- **Use only the specified replacement tires. Other tires may run the danger of bursting at super high speeds.**
- **Brand-new tires can have a relatively poor grip on certain road surfaces until they have been “broken in”. Therefore, it is advisable before doing any high-speed riding to ride conservatively for approximately 100 km (60 mi) after installing a new tire.**
- **The tires must be warmed up before a high-speed run.**
- **Always adjust the tire air pressure according to the operating conditions.**

Periodic maintenance and adjustment

EAU49713

EAU42851

Spoke wheels

To maximize the performance, durability, and safe operation of your vehicle, note the following points.

- Check each wheel for cracks, deformation and other damage. If any damage is found, have the wheel inspected by your Yamaha dealer. Do not attempt to repair or straighten a bent or damaged wheel.
- Check the spokes for looseness. If any loose spokes are found, have the wheel adjusted by your Yamaha dealer. Improperly tightened spokes can cause wheel misalignment.
- Have the wheel balanced whenever the tire or tube has been replaced. An unbalanced wheel can result in adverse handling characteristics and shortened tire life.

Clutch lever

Since this model is equipped with a hydraulic clutch, adjusting the clutch lever free play is not needed. However, it is necessary to check the hydraulic system for leakage before each ride. If the clutch lever free play does become excessive, and shifting becomes rough or clutch slippage occurs, causing poor acceleration, there may be air in the clutch system. If there is air in the hydraulic system, have a Yamaha dealer bleed the system before operating the motorcycle.

EAU37914

EAU36505

Checking the brake lever free play

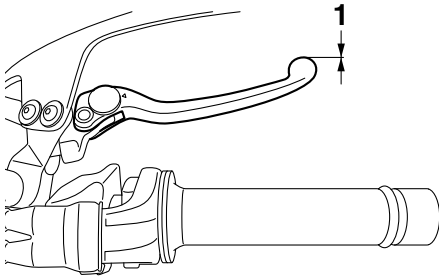

1. No brake lever free play

There should be no free play at the brake lever end. If there is free play, have a Yamaha dealer inspect the brake system.

EWA14212

WARNING

A soft or spongy feeling in the brake lever can indicate the presence of air in the hydraulic system. If there is air in the hydraulic system, have a Yamaha dealer bleed the system before operating the vehicle. Air in the hydraulic system will diminish the braking performance, which may result in loss of control and an accident.

Brake light switches

The brake light should come on just before braking takes effect. The brake light is activated by switches connected to the brake lever and brake pedal. Since the brake light switches are components of the anti-lock brake system, they should only be serviced by a Yamaha dealer.

Periodic maintenance and adjustment

Checking the front and rear brake pads

EAU22393

The front and rear brake pads must be checked for wear at the intervals specified in the periodic maintenance and lubrication chart.

Front brake pads

EAU36891

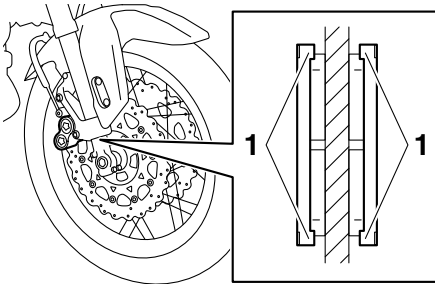

1. Brake pad wear indicator

Each front brake pad is provided with wear indicators, which allows you to check the brake pad wear without having to disassemble the brake. To check the brake pad wear, check the position of the wear indicators while applying the brake. If a brake pad has worn to the point that a wear indicator almost touches the brake disc, have a Yamaha dealer replace the brake pads as a set.

Rear brake pads

EAU22501

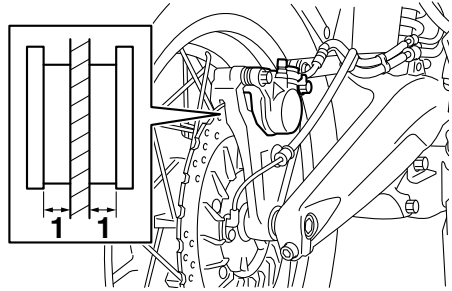

1. Lining thickness

Check each rear brake pad for damage and measure the lining thickness. If a brake pad is damaged or if the lining thickness is less than 0.8 mm (0.03 in), have a Yamaha dealer replace the brake pads as a set.

Periodic maintenance and adjustment

Checking the brake fluid level

EAU40262

Before riding, check that the brake fluid is above the minimum level mark. Check the brake fluid level with the top of the reservoir level. Replenish the brake fluid if necessary.

Front brake

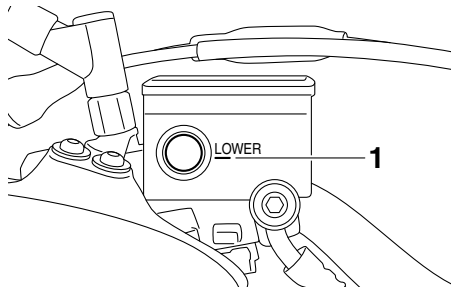

1. Minimum level mark

Rear brake

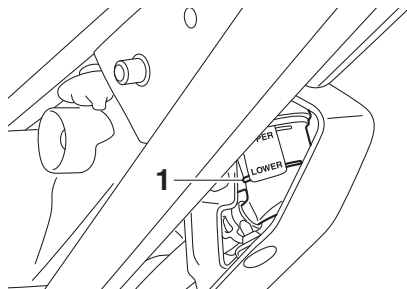

1. Minimum level mark

Specified brake fluid:
DOT 4

EWA16011

! WARNING

Improper maintenance can result in loss of braking ability. Observe these precautions:

- Insufficient brake fluid may allow air to enter the brake system, reducing braking performance.

- Clean the filler cap before removing. Use only DOT 4 brake fluid from a sealed container.
- Use only the specified brake fluid; otherwise, the rubber seals may deteriorate, causing leakage.
- Refill with the same type of brake fluid. Adding a brake fluid other than DOT 4 may result in a harmful chemical reaction.
- Be careful that water or dust does not enter the brake fluid reservoir when refilling. Water will significantly lower the boiling point of the fluid and may result in vapor lock, and dirt may clog the ABS hydraulic unit valves.

ECA17641

NOTICE

Brake fluid may damage painted surfaces or plastic parts. Always clean up spilled fluid immediately.

As the brake pads wear, it is normal for the brake fluid level to gradually go down. A low brake fluid level may indicate worn brake pads and/or brake system leakage; therefore, be sure to check the brake pads for wear and the brake system for leakage. If the brake fluid level goes down suddenly, have a Yamaha dealer check the cause before further riding.

Periodic maintenance and adjustment

EAU22754

Changing the brake and clutch fluids

Have a Yamaha dealer change the brake and clutch fluids at the intervals specified in the periodic maintenance and lubrication chart. In addition, have the oil seals of the brake and clutch master cylinders and calipers as well as the brake and clutch hoses replaced at the intervals listed below or whenever they are damaged or leaking.

- Oil seals: Replace every two years.
- Brake and clutch hoses: Replace every four years.

EAU23115

Checking and lubricating the throttle grip and cable

The operation of the throttle grip should be checked before each ride. In addition, the cable should be lubricated by a Yamaha dealer at the intervals specified in the periodic maintenance chart.

The throttle cable is equipped with a rubber cover. Make sure that the cover is securely installed. Even though the cover is installed correctly, it does not completely protect the cable from water entry. Therefore, use care not to pour water directly onto the cover or cable when washing the vehicle. If the cable or cover becomes dirty, wipe clean with a moist cloth.

Periodic maintenance and adjustment

EAU44276

Checking and lubricating the brake and shift pedals

The operation of the brake and shift pedals should be checked before each ride, and the pedal pivots should be lubricated if necessary.

Brake pedal

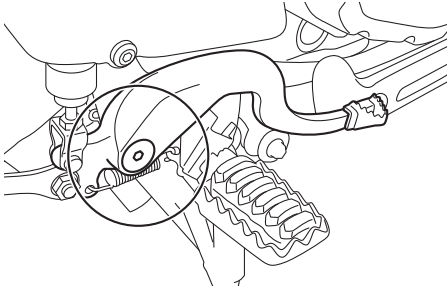

Shift pedal

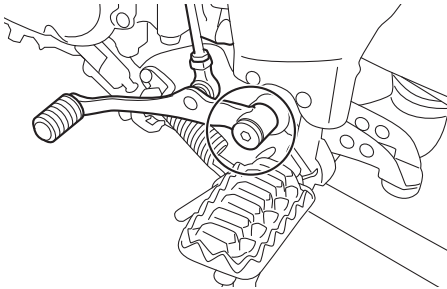

Recommended lubricant:
Lithium-soap-based grease

EAU43602

Checking and lubricating the brake and clutch levers

The operation of the brake and clutch levers should be checked before each ride, and the lever pivots should be lubricated if necessary.

Brake lever

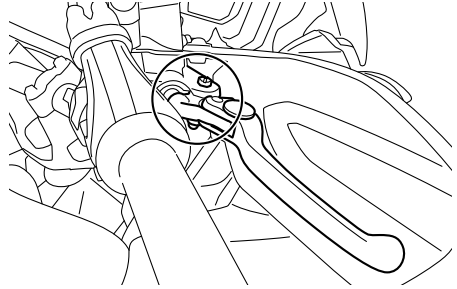

Clutch lever

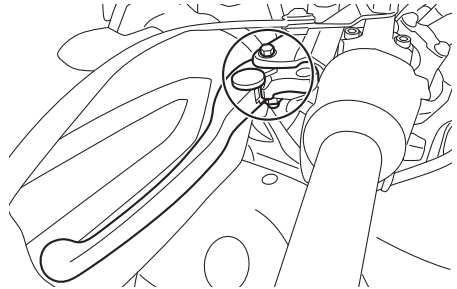

Recommended lubricant:
Silicone grease

Periodic maintenance and adjustment

Checking and lubricating the centerstand and sidestand

EAU23215

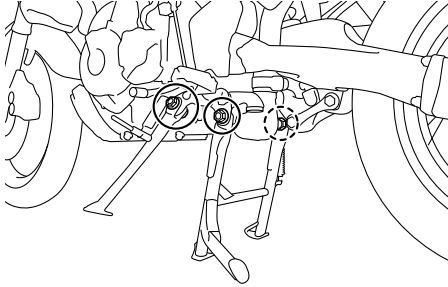

The operation of the centerstand and sidestand should be checked before each ride, and the pivots and metal-to-metal contact surfaces should be lubricated if necessary.

EWA10742

WARNING

If the centerstand or sidestand does not move up and down smoothly, have a Yamaha dealer check or repair it. Otherwise, the centerstand or sidestand could contact the ground and distract the operator, resulting in a possible loss of control.

Recommended lubricant:
Lithium-soap-based grease

Lubricating the swingarm pivots

EAUM1653

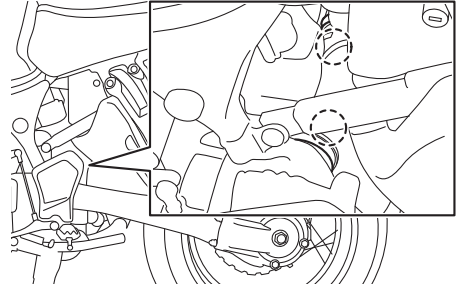

The swingarm pivots must be lubricated by a Yamaha dealer at the intervals specified in the periodic maintenance and lubrication chart.

Recommended lubricant:
Lithium-soap-based grease

Periodic maintenance and adjustment

EAU23273

EAU45512

Checking the front fork

The condition and operation of the front fork must be checked as follows at the intervals specified in the periodic maintenance and lubrication chart.

To check the condition

Check the inner tubes for scratches, damage and excessive oil leakage.

To check the operation

1. Place the vehicle on a level surface and hold it in an upright position. **WARNING! To avoid injury, securely support the vehicle so there is no danger of it falling over.** [EWA10752]
2. While applying the front brake, push down hard on the handlebars several times to check if the front fork compresses and rebounds smoothly.

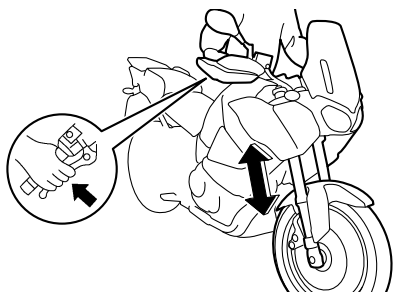

ECA10591

NOTICE

If any damage is found or the front fork does not operate smoothly, have a Yamaha dealer check or repair it.

Checking the steering

Worn or loose steering bearings may cause danger. Therefore, the operation of the steering must be checked as follows at the intervals specified in the periodic maintenance and lubrication chart.

1. Place the vehicle on the centerstand. **WARNING! To avoid injury, securely support the vehicle so there is no danger of it falling over.** [EWA10752]
2. Hold the lower ends of the front fork legs and try to move them forward and backward. If any free play can be felt, have a Yamaha dealer check or repair the steering.

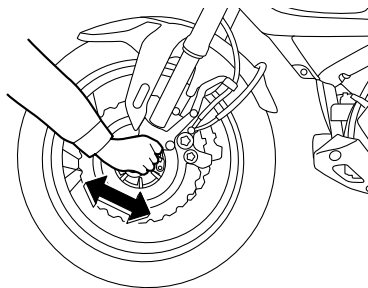

Periodic maintenance and adjustment

Checking the wheel bearings

EAU23292

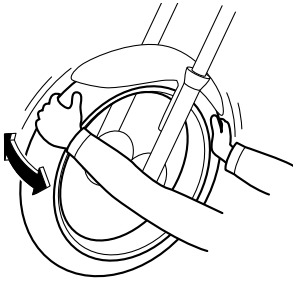

The front and rear wheel bearings must be checked at the intervals specified in the periodic maintenance and lubrication chart. If there is play in the wheel hub or if the wheel does not turn smoothly, have a Yamaha dealer check the wheel bearings.

6

Battery

EAU34227

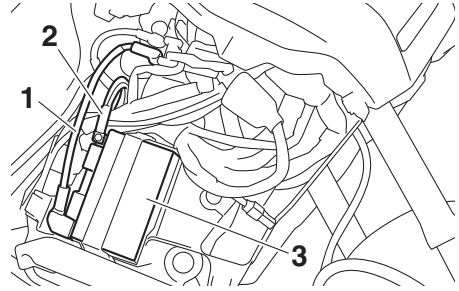

1. Positive battery lead (red)
2. Negative battery lead (black)
3. Battery

The battery is located behind cowling A. (See page 6-7.)

This model is equipped with a VRLA (Valve Regulated Lead Acid) battery. There is no need to check the electrolyte or to add distilled water. However, the battery lead connections need to be checked and, if necessary, tightened.

EWA10761

WARNING

- **Electrolyte is poisonous and dangerous since it contains sulfuric acid, which causes severe burns. Avoid any contact with skin, eyes or clothing and always shield your eyes when working near batteries. In case of contact, administer the following FIRST AID.**
 - **EXTERNAL:** Flush with plenty of water.
 - **INTERNAL:** Drink large quantities of water or milk and immediately call a physician.
 - **EYES:** Flush with water for 15 minutes and seek prompt medical attention.

Periodic maintenance and adjustment

- **Batteries produce explosive hydrogen gas. Therefore, keep sparks, flames, cigarettes, etc., away from the battery and provide sufficient ventilation when charging it in an enclosed space.**
 - **KEEP THIS AND ALL BATTERIES OUT OF THE REACH OF CHILDREN.**
-

To charge the battery

Have a Yamaha dealer charge the battery as soon as possible if it seems to have discharged. Keep in mind that the battery tends to discharge more quickly if the vehicle is equipped with optional electrical accessories.

ECA16522

NOTICE

To charge a VRLA (Valve Regulated Lead Acid) battery, a special (constant-voltage) battery charger is required. Using a conventional battery charger will damage the battery.

To store the battery

1. If the vehicle will not be used for more than one month, remove the battery, fully charge it, and then place it in a cool, dry place.
NOTICE: When removing the battery, be sure to turn the main switch off, then disconnect the negative lead before disconnecting the positive lead. [ECA16304]
2. If the battery will be stored for more than two months, check it at least once a month and fully charge it if necessary.

3. Fully charge the battery before installation. **NOTICE: When installing the battery, be sure to turn the main switch off, then connect the positive lead before connecting the negative lead.**
[ECA16842]
4. After installation, make sure that the battery leads are properly connected to the battery terminals.

ECA16531

NOTICE

Always keep the battery charged. Storing a discharged battery can cause permanent battery damage.

Periodic maintenance and adjustment

EAU58963

Replacing the fuses

The fuse boxes and the ABS motor fuse are located behind cowling A, and the main fuse, the cruise control fuse and the brake light fuse are located behind cowling B. (See page 6-7.)

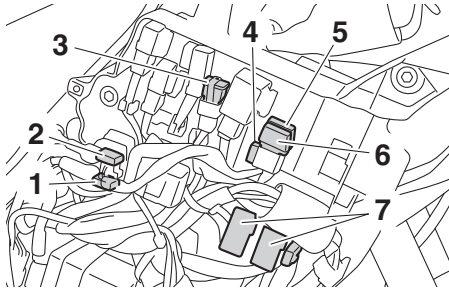

1. ABS motor fuse
2. ABS motor spare fuse
3. Main fuse
4. Spare fuse
5. Cruise control fuse
6. Brake light fuse
7. Fuse box

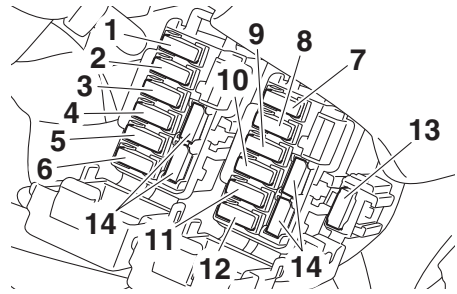

1. Headlight fuse
2. ABS solenoid fuse
3. Electronic throttle valve fuse
4. Fuel injection system fuse
5. Backup fuse (for clock and immobilizer system)
6. Radiator fan motor fuse
7. Ignition fuse
8. Signaling system fuse
9. ABS control unit fuse
10. Terminal fuse 1 (for auxiliary DC jack)
11. Parking lighting fuse
12. O/P (option) fuse
13. Suspension fuse
14. Spare fuse

If a fuse is blown, replace it as follows.

1. Turn the key to "OFF" and turn off the electrical circuit in question.
2. Remove the blown fuse, and then install a new fuse of the specified amperage. **WARNING! Do not use a fuse of a higher amperage rating than recommended to avoid causing extensive damage to the electrical system and possibly a fire.** [EWA15132]

Periodic maintenance and adjustment

EAU39014

Specified fuses:

Main fuse:	50.0 A
Terminal fuse 1:	3.0 A
Headlight fuse:	20.0 A
Brake light fuse:	1.0 A
Parking lighting fuse:	7.5 A
Signaling system fuse:	7.5 A
Ignition fuse:	20.0 A
Radiator fan motor fuse:	20.0 A
Backup fuse:	7.5 A
Electronic throttle valve fuse:	7.5 A
Fuel injection system fuse:	20.0 A
ABS solenoid fuse:	20.0 A
ABS control unit fuse:	7.5 A
ABS motor fuse:	30.0 A
Suspension fuse:	15.0 A
Cruise control fuse:	1.0 A
O/P (option) fuse:	20.0 A

Replacing a headlight bulb

This model is equipped with halogen bulb headlights. If a headlight bulb burns out, replace it as follows.

ECA10651

NOTICE

Take care not to damage the following parts:

- **Headlight bulb**

Do not touch the glass part of the headlight bulb to keep it free from oil, otherwise the transparency of the glass, the luminosity of the bulb, and the bulb life will be adversely affected. Thoroughly clean off any dirt and fingerprints on the headlight bulb using a cloth moistened with alcohol or thinner.

- **Headlight lens**

Do not affix any type of tinted film or stickers to the headlight lens.

Do not use a headlight bulb of a wattage higher than specified.

6

3. Turn the key to "ON" and turn on the electrical circuit in question to check if the device operates.
4. If the fuse immediately blows again, have a Yamaha dealer check the electrical system.

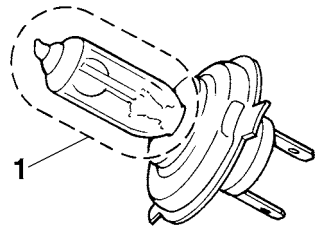

1. Do not touch the glass part of the bulb.

1. Remove the headlight bulb cover by turning it counterclockwise.

Periodic maintenance and adjustment

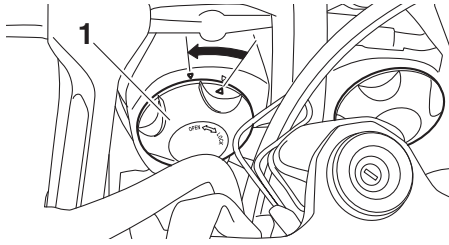

6. Install the headlight bulb cover by turning it clockwise.
7. Have a Yamaha dealer adjust the headlight beam if necessary.

1. Headlight bulb cover
2. Disconnect the headlight coupler.

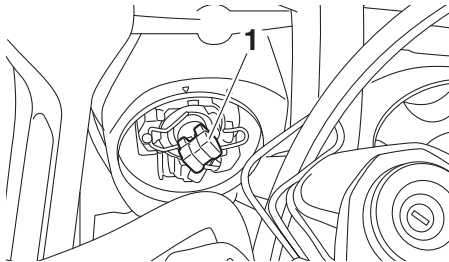

1. Headlight coupler
3. Unhook the headlight bulb holder, and then remove the burnt-out bulb.

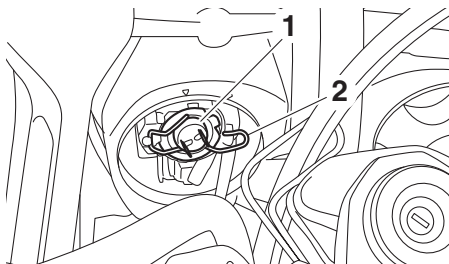

1. Headlight bulb
2. Headlight bulb holder
4. Place a new headlight bulb into position, and then secure it with the bulb holder.
5. Connect the headlight coupler.

Periodic maintenance and adjustment

EAU58971

Replacing an auxiliary light bulb

This model is equipped with two auxiliary lights. If an auxiliary light bulb burns out, replace it as follows.

1. Remove the windshield by removing the screws.

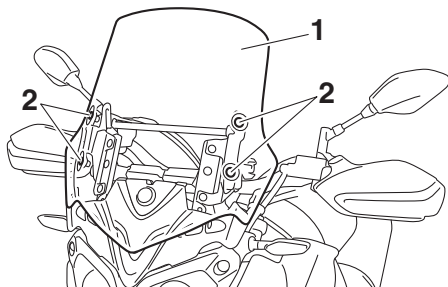

1. Windshield
2. Screw

2. Remove the cover by pulling it outward.

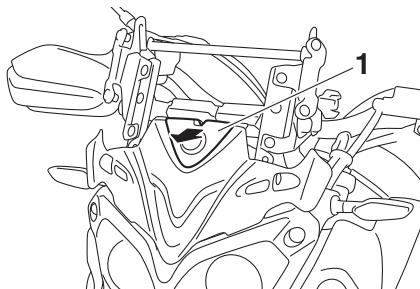

1. Cover

3. Remove the panel by removing the screws and the quick fastener screw.

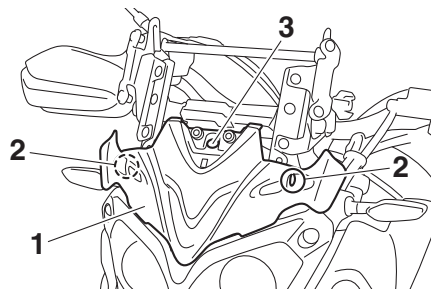

1. Panel
2. Screw
3. Quick fastener screw

4. Remove the headlight unit cover by removing the bolts.

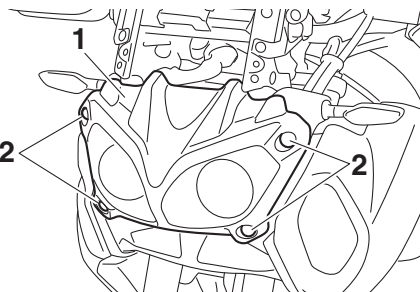

1. Headlight unit cover
2. Bolt

5. Remove the headlight unit bolts, then pull the headlight unit slightly out, making sure that it remains supported. **NOTICE: Be careful not to pull the headlight leads.**

[ECA16811]

Periodic maintenance and adjustment

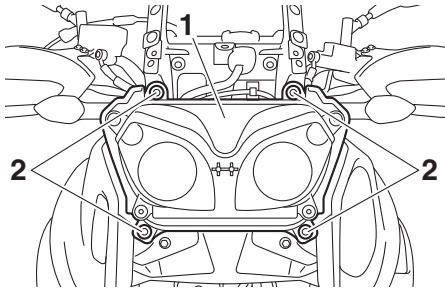

1. Headlight unit
2. Headlight unit bolt

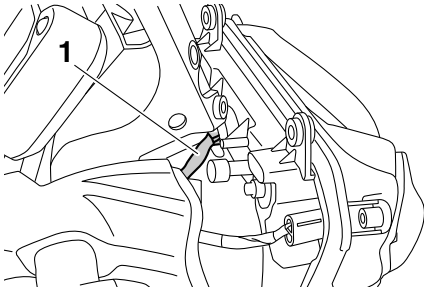

1. Headlight lead

6. Remove the auxiliary light bulb socket (together with the bulb) by turning the socket counterclockwise.

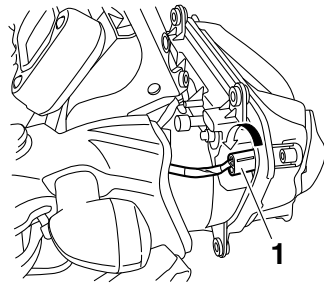

1. Auxiliary light bulb socket

7. Remove the burnt-out bulb by pulling it out.

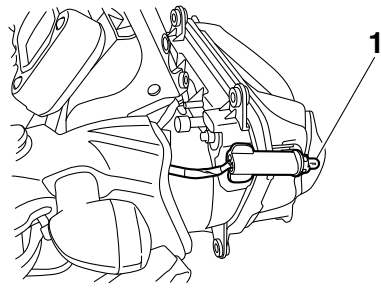

1. Auxiliary light bulb

8. Insert a new bulb into the socket.
9. Install the socket (together with the bulb) by pushing it in and turning it clockwise.
10. Install the headlight unit by installing the bolts, and then tightening them to the specified torque.

Tightening torque:

Headlight unit bolt:

7 N·m (0.7 kgf·m, 5.2 lb·ft)

11. Install the headlight unit cover by installing the bolts.
12. Install the panel by installing the screws and the quick fastener screw.
13. Install the cover.

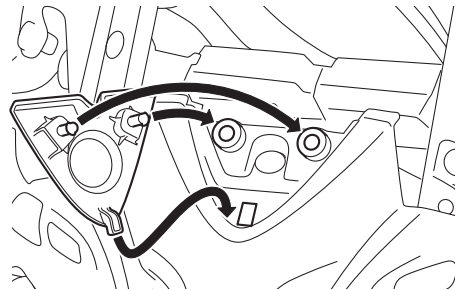

14. Install the windshield by installing the screws, and then tightening them to the specified torque.

WARNING! A loose windshield

Periodic maintenance and adjustment

could cause an accident. Be sure to tighten the screws to the specified torque. [EWA1551]

Tightening torque:

Windshield screw:

0.5 N·m (0.05 kgf·m, 0.37 lb·ft)

EAU70570

Turn signal light and brake/tail light

This model is equipped with LED-type turn signal lights and an LED-type brake/tail light.

If a turn signal light or the brake/tail light does not come on, have a Yamaha dealer check it.

Periodic maintenance and adjustment

EAU49722

Replacing a license plate light bulb

1. Remove the license plate light unit bolts.

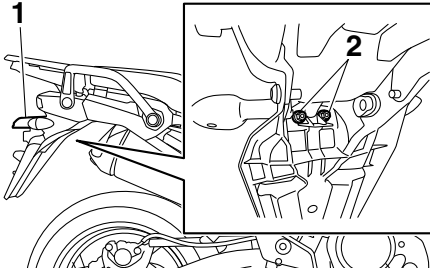

1. License plate light unit
2. License plate light unit bolt

2. Remove the license plate light bulb socket (together with the bulb) by turning it counterclockwise, and then pulling it out.

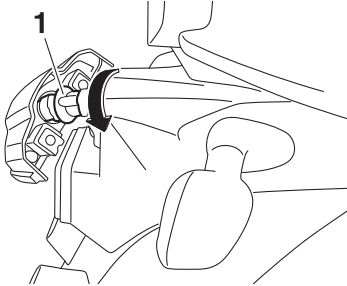

1. License plate light bulb socket

3. Remove the burnt-out bulb by pulling it out.

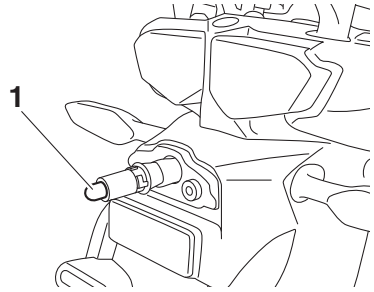

1. License plate light bulb

4. Insert a new bulb into the socket.
5. Install the socket (together with the bulb) by pushing it in, and then turning it clockwise until it stops.
6. Place the license plate light unit in the original position, and then install the bolts.

EAU25872

Troubleshooting

Although Yamaha motorcycles receive a thorough inspection before shipment from the factory, trouble may occur during operation. Any problem in the fuel, compression, or ignition systems, for example, can cause poor starting and loss of power.

The following troubleshooting charts represent quick and easy procedures for checking these vital systems yourself. However, should your motorcycle require any repair, take it to a Yamaha dealer, whose skilled technicians have the necessary tools, experience, and know-how to service the motorcycle properly.

Use only genuine Yamaha replacement parts. Imitation parts may look like Yamaha parts, but they are often inferior, have a shorter service life and can lead to expensive repair bills.

EWA15142

WARNING

When checking the fuel system, do not smoke, and make sure there are no open flames or sparks in the area, including pilot lights from water heaters or furnaces. Gasoline or gasoline vapors can ignite or explode, causing severe injury or property damage.

Periodic maintenance and adjustment

EAU63470

Troubleshooting charts

Starting problems or poor engine performance

1. Fuel

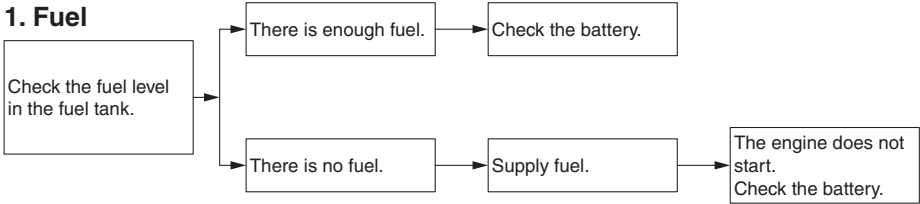

2. Battery

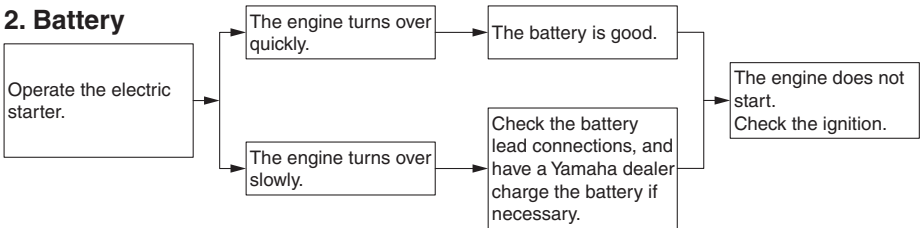

3. Ignition

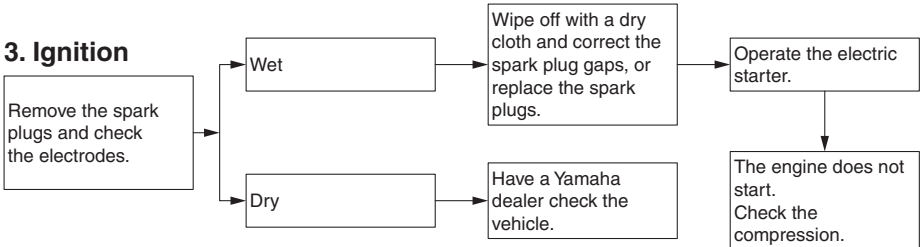

4. Compression

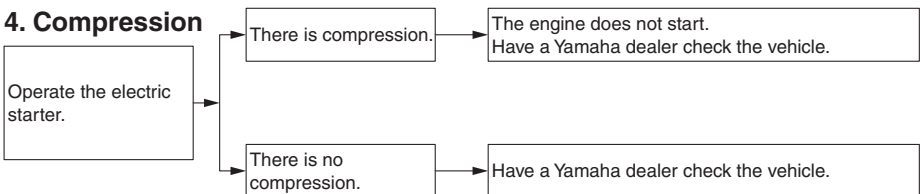

Periodic maintenance and adjustment

Engine overheating

EWAT1041

! WARNING

- Do not remove the radiator cap when the engine and radiator are hot. Scalding hot fluid and steam may be blown out under pressure, which could cause serious injury. Be sure to wait until the engine has cooled.
- Place a thick rag, like a towel, over the radiator cap, and then slowly rotate the cap counterclockwise to the detent to allow any residual pressure to escape. When the hissing sound has stopped, press down on the cap while turning it counterclockwise, and then remove the cap.

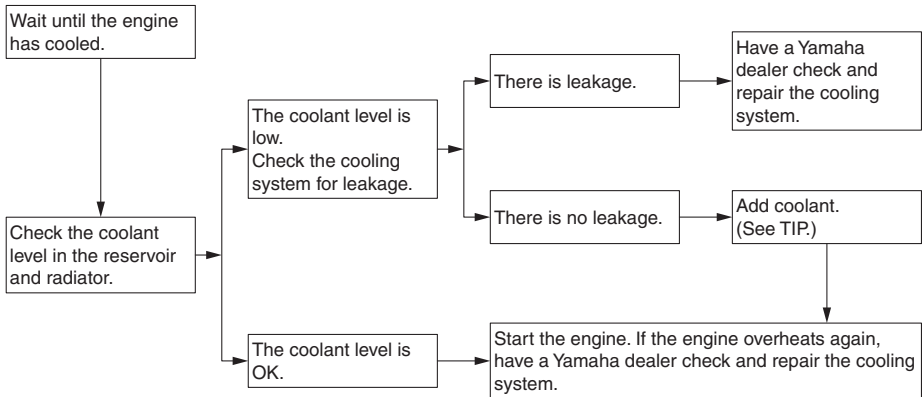

6

TIP

If coolant is not available, tap water can be temporarily used instead, provided that it is changed to the recommended coolant as soon as possible.

Motorcycle care and storage

Matte color caution

EAU37834

EAU83443

NOTICE

ECA15193

Some models are equipped with matte colored finished parts. Be sure to consult a Yamaha dealer for advice on what products to use before cleaning the vehicle. Using a brush, harsh chemical products or cleaning compounds when cleaning these parts will scratch or damage their surface. Wax also should not be applied to any matte colored finished parts.

Care

Frequent, thorough cleaning of the vehicle will not only enhance its appearance but also will improve its general performance and extend the useful life of many components. Washing, cleaning, and polishing will also give you a chance to inspect the condition of the vehicle more frequently. Be sure to wash the vehicle after riding in the rain or near the sea, because salt is corrosive to metals.

TIP

- The roads of heavy snowfall areas may be sprayed with salt as a de-icing method. This salt can stay on the roads well into spring, so be sure to wash the underside and chassis parts after riding in such areas.
 - Genuine Yamaha care and maintenance products are sold under the YAMALUBE brand in many markets worldwide.
 - See your Yamaha dealer for additional cleaning tips.
-

ECA26280

NOTICE

Improper cleaning can cause cosmetic and mechanical damage. Do not use:

- high-pressure washers or steam-jet cleaners. Excessive water pressure may cause water seepage and deterioration of wheel bearings, brakes, transmission seals and electrical devices. Avoid high-pressure detergent applications such as those available in coin-operated car washers.

Motorcycle care and storage

- harsh chemicals, including strong acidic wheel cleaners, especially on spoke or magnesium wheels.
- harsh chemicals, abrasive cleaning compounds, or wax on matte-finished parts. Brushes can scratch and damage the matte-finish, use soft sponge or towel only.
- towels, sponges, or brushes contaminated with abrasive cleaning products or strong chemicals such as, solvents, gasoline, rust removers, brake fluid, or antifreeze, etc.

Before washing

1. Park the vehicle out of direct sunlight and allow it to cool. This will help avoid water spots.
2. Make sure all caps, covers, electrical couplers and connectors are tightly installed.
3. Cover the muffler end with a plastic bag and a strong rubber band.
4. Pre-soak stubborn stains like insects or bird droppings with a wet towel for a few minutes.
5. Remove road grime and oil stains with a quality degreasing agent and a plastic-bristle brush or sponge. **NOTICE: Do not use degreasing agent on areas requiring lubrication such as seals, gaskets, and wheel axles. Follow product instructions.**

[ECA26290]

Washing

1. Rinse off any degreaser and spray down the vehicle with a garden hose. Use only enough pressure to do the job. Avoid spraying water directly into the muffler, instrument panel, air inlet, or other inner areas such as underseat storage compartments.
2. Wash the vehicle with a quality automotive-type detergent mixed with cool water and a soft, clean towel or sponge. Use an old toothbrush or plastic-bristle brush for hard-to-reach places. **NOTICE: Use cold water if the vehicle has been exposed to salt. Warm water will increase salt's corrosive properties.** [ECA26301]
3. For windshield-equipped vehicles: Clean the windshield with a soft towel or sponge dampened with water and a pH neutral detergent. If necessary, use a high-quality windshield cleaner or polish for motorcycles. **NOTICE: Never use any strong chemicals to clean the windshield. Additionally, some cleaning compounds for plastic may scratch the windshield, so be sure to test all cleaning products before general application.** [ECA26310]
4. Rinse off thoroughly with clean water. Be sure to remove all detergent residues, as they can be harmful to plastic parts.

After washing

1. Dry the vehicle with a chamois or absorbent towel, preferably microfiber terrycloth.

Motorcycle care and storage

ECA26320

2. For drive chain-equipped models: Dry and then lubricate the drive chain to prevent rust.
3. Use a chrome polish to shine chrome, aluminum, and stainless steel parts. Often the thermally induced discoloring of stainless steel exhaust systems can be removed through polishing.
4. Apply a corrosion protection spray on all metal parts including chrome or nickel-plated surfaces.
WARNING! Do not apply silicone or oil spray to seats, hand grips, rubber foot pegs or tire treads. Otherwise these parts will become slippery, which could cause loss of control. Thoroughly clean the surfaces of these parts before operating the vehicle. [EWA20650]
5. Treat rubber, vinyl, and unpainted plastic parts with a suitable care product.
6. Touch up minor paint damage caused by stones, etc.
7. Wax all painted surfaces using a non-abrasive wax or use a detail spray for motorcycles.
8. When finished cleaning, start the engine and let it idle for several minutes to help dry any remaining moisture.
9. If the headlight lens has fogged up, start the engine and turn on the headlight to help remove the moisture.
10. Let the vehicle dry completely before storing or covering it.

NOTICE

- Do not apply wax to rubber or unpainted plastic parts.
 - Do not use abrasive polishing compounds as they will wear away the paint.
 - Apply sprays and wax sparingly. Wipe off excess afterwards.
-

EWA20660

WARNING

Contaminants left on the brakes or tires can cause loss of control.

- Make sure there is no lubricant or wax on the brakes or tires.
 - If necessary, wash the tires with warm water and a mild detergent.
 - If necessary, clean the brake discs and pads with brake cleaner or acetone.
 - Before riding at higher speeds, test the vehicle's braking performance and cornering behavior.
-

EAU83472

Storage

Always store the vehicle in a cool, dry place. If necessary, protect it against dust with a porous cover. Be sure the engine and the exhaust system are cool before covering the vehicle. If the vehicle often sits for weeks at a time between uses, the use of a quality fuel stabilizer is recommended after each fill-up.

ECA21170

NOTICE

- **Storing the vehicle in a poorly ventilated room or covering it with a tarp, while it is still wet, will allow water and humidity to seep in and cause rust.**
- **To prevent corrosion, avoid damp cellars, stables (because of the presence of ammonia) and areas where strong chemicals are stored.**

Long term storage

Before storing the vehicle long term (60 days or more):

1. Make all necessary repairs and perform any outstanding maintenance.
2. Follow all instructions in the Care section of this chapter.
3. Fill up the fuel tank, adding fuel stabilizer according to product instructions. Run the engine for 5 minutes to distribute treated fuel through the fuel system.
4. For vehicles equipped with a fuel cock: Turn the fuel cock lever to the off position.

5. For vehicles with a carburetor: To prevent fuel deposits from building up, drain the fuel in the carburetor float chamber into a clean container. Retighten the drain bolt and pour the fuel back into the fuel tank.

6. Use a quality engine fogging oil according to product instructions to protect internal engine components from corrosion. If engine fogging oil is not available, perform the following steps for each cylinder:

- a. Remove the spark plug cap and spark plug.
- b. Pour a teaspoonful of engine oil into the spark plug bore.
- c. Install the spark plug cap onto the spark plug, and then place the spark plug on the cylinder head so that the electrodes are grounded. (This will limit sparking during the next step.)
- d. Turn the engine over several times with the starter. (This will coat the cylinder wall with oil.)

WARNING! To prevent damage or injury from sparking, make sure to ground the spark plug electrodes while turning the engine over.

[EWA10952]

- e. Remove the spark plug cap from the spark plug, and then install the spark plug and the spark plug cap.
7. Lubricate all control cables, pivots, levers and pedals, as well as the sidestand and centerstand (if equipped).

Motorcycle care and storage

8. Check and correct the tire air pressure, and then lift the vehicle so that all wheels are off the ground. Otherwise, turn the wheels a little once a month in order to prevent the tires from becoming degraded in one spot.
9. Cover the muffler outlet with a plastic bag to prevent moisture from entering it.
10. Remove the battery and fully charge it, or attach a maintenance charger to keep the battery optimally charged. **NOTICE: Confirm that the battery and its charger are compatible. Do not charge a VRLA battery with a conventional charger.** [ECA26330]

TIP

- If the battery will be removed, charge it once a month and store it in a temperate location between 0-30 °C (32-90 °F).
 - See page 6-30 for more information on charging and storing the battery.
-

Dimensions:

- Overall length:
2250 mm (88.6 in)
- Overall width:
980 mm (38.6 in)
- Overall height:
1410/1470 mm (55.5/57.9 in)
- Seat height:
845/870 mm (33.3/34.3 in)
- Wheelbase:
1540 mm (60.6 in)
- Ground clearance:
190 mm (7.48 in)
- Minimum turning radius:
2.7 m (8.86 ft)

Weight:

- Curb weight:
266 kg (586 lb)

Engine:

- Combustion cycle:
4-stroke
- Cooling system:
Liquid cooled
- Valve train:
DOHC
- Cylinder arrangement:
Inline
- Number of cylinders:
2-cylinder
- Displacement:
1199 cm³
- Bore × stroke:
98.0 × 79.5 mm (3.86 × 3.13 in)
- Starting system:
Electric starter

Engine oil:

- Recommended brand:



- SAE viscosity grades:
10W-40
- Recommended engine oil grade:
API service SG type or higher, JASO standard MA
- Engine oil quantity:
Oil change:
3.10 L (3.28 US qt, 2.73 Imp.qt)

- With oil filter removal:
3.40 L (3.59 US qt, 2.99 Imp.qt)

Final gear oil:

- Type:
Yamaha genuine shaft drive gear oil SAE 80W-90 API GL-5 or SAE 80 API GL-4 Hypoid gear oil
- Quantity:
0.20 L (0.21 US qt, 0.18 Imp.qt)

Coolant quantity:

- Coolant reservoir (up to the maximum level mark):
0.26 L (0.27 US qt, 0.23 Imp.qt)
- Radiator (including all routes):
1.83 L (1.93 US qt, 1.61 Imp.qt)

Fuel:

- Recommended fuel:
Premium unleaded gasoline (Gasohol [E10] acceptable)
- Fuel tank capacity:
23 L (6.1 US gal, 5.1 Imp.gal)
- Fuel reserve amount:
3.9 L (1.03 US gal, 0.86 Imp.gal)

Fuel injection:

- Throttle body:
ID mark:
BP81 00

Drivetrain:

- Gear ratio:
1st:
2.769 (36/13)
- 2nd:
2.063 (33/16)
- 3rd:
1.571 (33/21)
- 4th:
1.250 (30/24)
- 5th:
1.042 (25/24)
- 6th:
0.929 (26/28)

Front tire:

- Type:
Tubeless
- Size:
110/80R19M/C 59V
- Manufacturer/model:
BRIDGESTONE/BW501

Specifications

Rear tire:

Type:

Tubeless

Size:

150/70R17M/C 69V

Manufacturer/model:

BRIDGESTONE/BW502

License plate light:

5.0 W

Loading:

Maximum load:

204 kg (450 lb)

(Total weight of rider, passenger, cargo
and accessories)

Unified brake system:

Operation:

Activated by front brake

Front brake:

Type:

Hydraulic dual disc brake

Rear brake:

Type:

Hydraulic single disc brake

Front suspension:

Type:

Telescopic fork

Rear suspension:

Type:

Swingarm (link suspension)

Electrical system:

System voltage:

12 V

Battery:

Model:

YTZ12S

Voltage, capacity:

12 V, 11.0 Ah (10 HR)

Headlight:

Bulb type:

Halogen bulb

Bulb wattage:

Headlight:

H7, 55.0 W

Brake/tail light:

LED

Front turn signal light:

LED

Rear turn signal light:

LED

Auxiliary light:

5.0 W

Consumer information

Identification numbers

EAU53562

Record the vehicle identification number, engine serial number, and the model label information in the spaces provided below. These identification numbers are needed when registering the vehicle with the authorities in your area and when ordering spare parts from a Yamaha dealer.

VEHICLE IDENTIFICATION NUMBER:

ENGINE SERIAL NUMBER:

MODEL LABEL INFORMATION:

Vehicle identification number

EAU26401

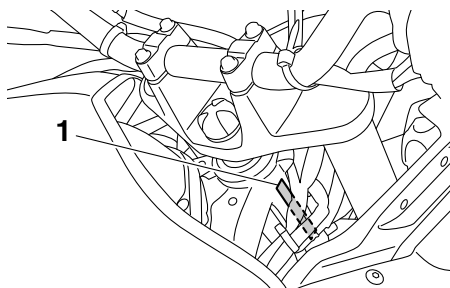

1. Vehicle identification number

The vehicle identification number is stamped into the steering head pipe. Record this number in the space provided.

TIP

The vehicle identification number is used to identify your motorcycle and may be used to register your motorcycle with the licensing authority in your area.

EAU26442

Engine serial number

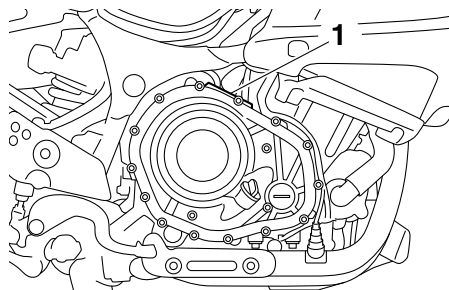

1. Engine serial number

The engine serial number is stamped into the crankcase.

EAU26471

Model label

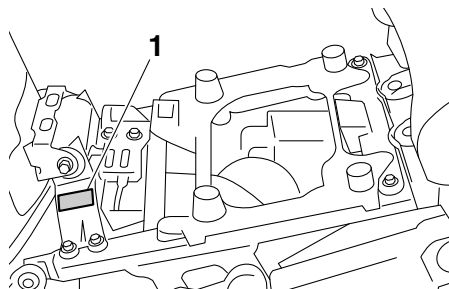

1. Model label

The model label is affixed to the frame under the rider seat. (See page 3-32.) Record the information on this label in

Consumer information

the space provided. This information will be needed when ordering spare parts from a Yamaha dealer.

EAU69910

Diagnostic connector

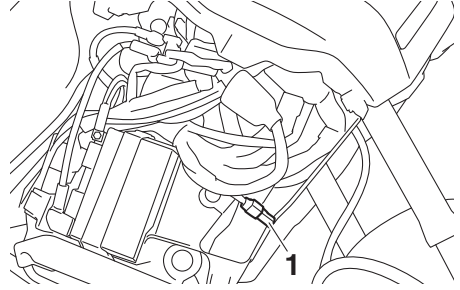

1. Diagnostic connector

The diagnostic connector is located as shown.

EAU85300

Vehicle data recording

This model's ECU stores certain vehicle data to assist in the diagnosis of malfunctions and for research, statistical analysis and development purposes.

Although the sensors and recorded data will vary by model, the main data points are:

- Vehicle status and engine performance data
- Fuel-injection and emission-related data

This data will be uploaded only when a special Yamaha diagnostic tool is attached to the vehicle, such as when maintenance checks or service procedures are performed.

Vehicle data uploaded will be handled appropriately according to the following Privacy Policy.

Privacy Policy

<https://www.yamaha-motor.eu/eu/privacy/privacy-policy.aspx>

Yamaha will not disclose this data to a third party except in the following cases. In addition, Yamaha may provide vehicle data to a contractor in order to outsource services related to the handling of vehicle data. Even in this case, Yamaha will require the contractor to properly handle the vehicle data we provided and Yamaha will appropriately manage the data.

- With the consent of the vehicle owner
- Where obligated by law
- For use by Yamaha in litigation
- When the data is not related to an individual vehicle nor owner

Index

- A**
 - ABS 3-26
 - ABS warning light 3-4
 - Air filter element 6-17
 - Auxiliary DC jack 3-41
 - Auxiliary light bulb, replacing 6-35
- B**
 - Battery 6-30
 - Brake and clutch fluids, changing 6-26
 - Brake and clutch levers, checking and lubricating 6-27
 - Brake and shift pedals, checking and lubricating 6-27
 - Brake fluid level, checking 6-25
 - Brake lever 3-24
 - Brake lever free play, checking 6-23
 - Brake light switches 6-23
 - Brake pedal 3-25
- C**
 - Canister 6-10
 - Care 7-1
 - Carriers 3-40
 - Catalytic converter 3-31
 - Centerstand and sidestand, checking and lubricating 6-28
 - Clutch lever 3-23, 6-22
 - Coolant 6-16
 - Cowlings, removing and installing 6-7
 - Cruise control indicator lights 3-4
 - Cruise control switches 3-23
 - Cruise control system 3-6
- D**
 - Data recording, vehicle 9-3
 - Diagnostic connector 9-2
 - Dimmer/Pass switch 3-22
 - D-mode (drive mode) 3-21
- E**
 - Engine break-in 5-5
 - Engine idling speed, checking 6-18
 - Engine oil 6-10
 - Engine serial number 9-1
 - Engine trouble warning light 3-4
- F**
 - Final gear oil 6-14
 - Front and rear brake pads, checking 6-24
 - Front fork, checking 6-29
 - Fuel 3-29
 - Fuel consumption, tips for reducing 5-4
 - Fuel tank cap 3-29
 - Fuel tank overflow hose 3-31
- Fuses, replacing 6-32
- H**
 - Handlebar switches 3-22
 - Hazard switch 3-22
 - Headlight bulb, replacing 6-33
 - High beam indicator light 3-3
 - Horn switch 3-22
- I**
 - Identification numbers 9-1
 - Ignition circuit cut-off system 3-43
 - Immobilizer system 3-1
 - Immobilizer system indicator light 3-5
 - Indicator lights and warning lights 3-3
- L**
 - License plate light bulb, replacing 6-38
 - Luggage strap holders 3-41
- M**
 - Main switch/steering lock 3-2
 - Maintenance and lubrication, periodic ... 6-4
 - Maintenance, emission control system 6-3
 - Matte color, caution 7-1
 - Menu switch 3-23
 - Model label 9-1
 - Multi-function meter unit 3-9
- N**
 - Neutral indicator light 3-3
- O**
 - Oil level warning light 3-4
- P**
 - Parking 5-6
 - Part locations 2-1
- R**
 - Rider seat 3-32
 - Rider seat height, adjusting 3-33
- S**
 - Safety information 1-1
 - Select switch 3-23
 - Shifting 5-3
 - Shift pedal 3-24
 - Sidestand 3-42
 - Spark plugs, checking 6-9
 - Specifications 8-1
 - Starting the engine 5-2
 - Steering, checking 6-29
 - Stop/Run/Start switch 3-22
 - Storage 7-4
 - Suspension, adjusting the front and rear 3-35
 - Suspension system warning light 3-5

Swingarm pivots, lubricating.....	6-28
T	
Throttle grip and cable, checking and lubricating	6-26
Throttle grip free play, checking.....	6-18
Tires.....	6-19
Tool kit.....	6-2
Traction control system.....	3-27
Traction control system indicator light...	3-5
Troubleshooting	6-39
Troubleshooting charts	6-40
Turn signal indicator lights	3-3
Turn signal light and brake/tail light	6-37
Turn signal switch	3-22
V	
Valve clearance	6-19
Vehicle identification number	9-1
W	
Wheel bearings, checking	6-30
Wheels.....	6-22
Windshield.....	3-34
Y	
Yamalube	6-13

