



 Read this manual carefully before operating this vehicle.

**OWNER'S MANUAL**

**MT-10**

**MTN1000**

**B67-28199-E4**

 **Read this manual carefully before operating this vehicle. This manual should stay with this vehicle if it is sold.**

## For Europe

Declaration of Conformity:

Hereby, YAMAHA MOTOR ELECTRONICS Co., Ltd declares that the radio equipment type, IMMOBILIZER, 1MC-00 is in compliance with Directive 2014/53/EU.

The full text of the EU declaration of conformity is available at the following internet address:

[https://global.yamaha-motor.com/eu\\_doc/](https://global.yamaha-motor.com/eu_doc/)

Frequency band: 134.2 kHz

The maximum radio frequency power: 49.0 [dB $\mu$ V/m]

Manufacturer:

YAMAHA MOTOR ELECTRONICS Co., Ltd

1450-6 Mori, Mori-machi, Shuchi-Gun, Shizuoka, 437-0292 Japan

Importer:

YAMAHA MOTOR EUROPE N.V.

Koolhovenlaan 101, 1119 NC Schiphol-Rijk, 1117 ZN, Schiphol, the Netherlands

## For South Africa



Welcome to the Yamaha world of motorcycling!

As the owner of the MTN1000, you are benefiting from Yamaha's vast experience and newest technology regarding the design and manufacture of high-quality products, which have earned Yamaha a reputation for dependability.

Please take the time to read this manual thoroughly, so as to enjoy all advantages of your MTN1000. The Owner's Manual does not only instruct you in how to operate, inspect and maintain your motorcycle, but also in how to safeguard yourself and others from trouble and injury.

In addition, the many tips given in this manual will help keep your motorcycle in the best possible condition. If you have any further questions, do not hesitate to contact your Yamaha dealer.

The Yamaha team wishes you many safe and pleasant rides. So, remember to put safety first!

Yamaha continually seeks advancements in product design and quality. Therefore, while this manual contains the most current product information available at the time of printing, there may be minor discrepancies between your motorcycle and this manual. If there is any question concerning this manual, please consult a Yamaha dealer.



---

**Please read this manual carefully and completely before operating this motorcycle.**





---

# Important manual information

---

EAU10134

Particularly important information is distinguished in this manual by the following notations:

	<b>This is the safety alert symbol. It is used to alert you to potential personal injury hazards. Obey all safety messages that follow this symbol to avoid possible injury or death.</b>
	<b>A WARNING indicates a hazardous situation which, if not avoided, could result in death or serious injury.</b>
	<b>A NOTICE indicates special precautions that must be taken to avoid damage to the vehicle or other property.</b>
	<b>A TIP provides key information to make procedures easier or clearer.</b>

\*Product and specifications are subject to change without notice.



EAU10201

**MTN1000  
OWNER'S MANUAL  
©2020 by Yamaha Motor Co., Ltd.  
1st edition, August 2019  
All rights reserved.  
Any reprinting or unauthorized use  
without the written permission of  
Yamaha Motor Co., Ltd.  
is expressly prohibited.  
Printed in Japan.**

# Table of contents

---

<b>Safety information</b> .....	1-1	Adjusting the front fork .....	4-22	Engine oil .....	7-10
<b>Description</b> .....	2-1	Adjusting the shock absorber assembly.....	4-24	Why Yamalube .....	7-14
Left view .....	2-1	Luggage strap holders .....	4-27	Coolant .....	7-14
Right view .....	2-2	EXUP system .....	4-27	Air filter element.....	7-15
Controls and instruments.....	2-3	Auxiliary DC jack.....	4-27	Checking the engine idling speed.....	7-16
<b>Special features</b> .....	3-1	Sidestand .....	4-28	Checking the throttle grip free play.....	7-16
Cruise control system .....	3-1	Ignition circuit cut-off system.....	4-29	Valve clearance .....	7-16
D-mode (drive mode).....	3-3	<b>For your safety – pre-operation checks</b> .....	5-1	Tires.....	7-17
Traction control system .....	3-4	<b>Operation and important riding points</b> .....	6-1	Cast wheels .....	7-19
Quick shift system .....	3-6	Starting the engine .....	6-1	Adjusting the clutch lever free play.....	7-19
<b>Instrument and control functions</b> .....	4-1	Shifting .....	6-2	Checking the brake lever free play.....	7-20
Immobilizer system.....	4-1	Tips for reducing fuel consumption .....	6-3	Brake light switches .....	7-21
Main switch/steering lock.....	4-2	Engine break-in .....	6-3	Checking the front and rear brake pads.....	7-21
Handlebar switches .....	4-3	Parking .....	6-4	Checking the brake fluid level.....	7-22
Indicator lights and warning lights.....	4-5	<b>Periodic maintenance and adjustment</b> .....	7-1	Changing the brake fluid.....	7-23
Multi-function meter unit .....	4-8	Tool kit.....	7-2	Drive chain slack.....	7-23
Clutch lever.....	4-16	Periodic maintenance charts.....	7-3	Cleaning and lubricating the drive chain .....	7-24
Shift pedal.....	4-16	Periodic maintenance chart for the emission control system .....	7-3	Checking and lubricating the cables .....	7-25
Brake lever .....	4-16	General maintenance and lubrication chart .....	7-5	Checking and lubricating the throttle grip and cable.....	7-25
Brake pedal .....	4-17	Checking the spark plugs.....	7-9	Checking and lubricating the brake and shift pedals .....	7-26
ABS .....	4-17	Canister.....	7-10	Checking and lubricating the brake and clutch levers .....	7-26
Fuel tank cap .....	4-18				
Fuel.....	4-19				
Fuel tank overflow hose.....	4-21				
Catalytic converter.....	4-21				
Seat .....	4-22				

# Table of contents

---

- Checking and lubricating the sidestand..... 7-27
- Lubricating the swingarm pivots..... 7-27
- Checking the front fork ..... 7-28
- Checking the steering..... 7-28
- Checking the wheel bearings ..... 7-29
- Battery ..... 7-29
- Replacing the fuses ..... 7-30
- Vehicle lights ..... 7-33
- Supporting the motorcycle..... 7-34
- Troubleshooting..... 7-34
- Troubleshooting charts..... 7-35

- Motorcycle care and storage** ..... 8-1
  - Matte color caution ..... 8-1
  - Care..... 8-1
  - Storage..... 8-4

- Specifications** ..... 9-1

- Consumer information** ..... 10-1
  - Identification numbers ..... 10-1
  - Diagnostic connector..... 10-2
  - Vehicle data recording..... 10-2

- Index** ..... 11-1

# Safety information

EAU1028C

1

## Be a Responsible Owner

As the vehicle's owner, you are responsible for the safe and proper operation of your motorcycle.

Motorcycles are single-track vehicles. Their safe use and operation are dependent upon the use of proper riding techniques as well as the expertise of the operator. Every operator should know the following requirements before riding this motorcycle.

He or she should:

- Obtain thorough instructions from a competent source on all aspects of motorcycle operation.
- Observe the warnings and maintenance requirements in this Owner's Manual.
- Obtain qualified training in safe and proper riding techniques.
- Obtain professional technical service as indicated in this Owner's Manual and/or when made necessary by mechanical conditions.
- Never operate a motorcycle without proper training or instruction.

Take a training course. Beginners should receive training from a certified instructor. Contact an authorized motorcycle dealer to find out about the training courses nearest you.

## Safe Riding

Perform the pre-operation checks each time you use the vehicle to make sure it is in safe operating condition. Failure to inspect or maintain the vehicle properly increases the possibility of an accident or equipment damage. See page 5-1 for a list of pre-operation checks.

- This motorcycle is designed to carry the operator and a passenger.
- The failure of motorists to detect and recognize motorcycles in traffic is the predominating cause of automobile/motorcycle accidents. Many accidents have been caused by an automobile driver who did not see the motorcycle. Making yourself conspicuous appears to be very effective in reducing the chance of this type of accident.

### Therefore:

- Wear a brightly colored jacket.

- Use extra caution when you are approaching and passing through intersections, since intersections are the most likely places for motorcycle accidents to occur.
- Ride where other motorists can see you. Avoid riding in another motorist's blind spot.
- Never maintain a motorcycle without proper knowledge. Contact an authorized motorcycle dealer to inform you on basic motorcycle maintenance. Certain maintenance can only be carried out by certified staff.
- Many accidents involve inexperienced operators. In fact, many operators who have been involved in accidents do not even have a current motorcycle license.
- Make sure that you are qualified and that you only lend your motorcycle to other qualified operators.
- Know your skills and limits. Staying within your limits may help you to avoid an accident.
- We recommend that you prac-

tice riding your motorcycle where there is no traffic until you have become thoroughly familiar with the motorcycle and all of its controls.

- Many accidents have been caused by error of the motorcycle operator. A typical error made by the operator is veering wide on a turn due to excessive speed or undercornering (insufficient lean angle for the speed).
- Always obey the speed limit and never travel faster than warranted by road and traffic conditions.
- Always signal before turning or changing lanes. Make sure that other motorists can see you.
- The posture of the operator and passenger is important for proper control.
  - The operator should keep both hands on the handlebar and both feet on the operator footrests during operation to maintain control of the motorcycle.
  - The passenger should always hold onto the operator, the seat strap or grab bar, if equipped,

with both hands and keep both feet on the passenger footrests. Never carry a passenger unless he or she can firmly place both feet on the passenger footrests.

- Never ride under the influence of alcohol or other drugs.
- This motorcycle is designed for on-road use only. It is not suitable for off-road use.

### **Protective Apparel**

The majority of fatalities from motorcycle accidents are the result of head injuries. The use of a safety helmet is the single most critical factor in the prevention or reduction of head injuries.

- Always wear an approved helmet.
- Wear a face shield or goggles. Wind in your unprotected eyes could contribute to an impairment of vision that could delay seeing a hazard.
- The use of a jacket, heavy boots, trousers, gloves, etc., is effective in preventing or reducing abrasions or lacerations.
- Never wear loose-fitting clothes, otherwise they could catch on the

control levers, footrests, or wheels and cause injury or an accident.

- Always wear protective clothing that covers your legs, ankles, and feet. The engine or exhaust system become very hot during or after operation and can cause burns.
- A passenger should also observe the above precautions.

### **Avoid Carbon Monoxide Poisoning**

All engine exhaust contains carbon monoxide, a deadly gas. Breathing carbon monoxide can cause headaches, dizziness, drowsiness, nausea, confusion, and eventually death.

Carbon Monoxide is a colorless, odorless, tasteless gas which may be present even if you do not see or smell any engine exhaust. Deadly levels of carbon monoxide can collect rapidly and you can quickly be overcome and unable to save yourself. Also, deadly levels of carbon monoxide can linger for hours or days in enclosed or poorly ventilated areas. If you experience any symptoms of carbon monoxide poisoning, leave the area immediately, get fresh air, and SEEK MEDICAL TREAT-

# Safety information

1

## MENT.

- Do not run engine indoors. Even if you try to ventilate engine exhaust with fans or open windows and doors, carbon monoxide can rapidly reach dangerous levels.
- Do not run engine in poorly ventilated or partially enclosed areas such as barns, garages, or carports.
- Do not run engine outdoors where engine exhaust can be drawn into a building through openings such as windows and doors.

## Loading

Adding accessories or cargo to your motorcycle can adversely affect stability and handling if the weight distribution of the motorcycle is changed. To avoid the possibility of an accident, use extreme caution when adding cargo or accessories to your motorcycle. Use extra care when riding a motorcycle that has added cargo or accessories. Here, along with the information about accessories below, are some general guidelines to follow if loading cargo to your motorcycle:

The total weight of the operator, passenger, accessories and cargo must not exceed the maximum load limit.

**Operation of an overloaded vehicle could cause an accident.**

<p><b>Maximum load:</b> 170 kg (375 lb)</p>
---

When loading within this weight limit, keep the following in mind:

- Cargo and accessory weight should be kept as low and close to the motorcycle as possible. Securely pack your heaviest items as close to the center of the vehicle as possible and make sure to distribute the weight as evenly as possible on both sides of the motorcycle to minimize imbalance or instability.
- Shifting weights can create a sudden imbalance. Make sure that accessories and cargo are securely attached to the motorcycle before riding. Check accessory mounts and cargo restraints frequently.
  - Properly adjust the suspension for your load (suspension-ad-

justable models only), and check the condition and pressure of your tires.

- Never attach any large or heavy items to the handlebar, front fork, or front fender. These items, including such cargo as sleeping bags, duffel bags, or tents, can create unstable handling or a slow steering response.
- **This vehicle is not designed to pull a trailer or to be attached to a sidecar.**

## Genuine Yamaha Accessories

Choosing accessories for your vehicle is an important decision. Genuine Yamaha accessories, which are available only from a Yamaha dealer, have been designed, tested, and approved by Yamaha for use on your vehicle.

Many companies with no connection to Yamaha manufacture parts and accessories or offer other modifications for Yamaha vehicles. Yamaha is not in a position to test the products that these aftermarket companies produce. Therefore, Yamaha can neither en-

dorse nor recommend the use of accessories not sold by Yamaha or modifications not specifically recommended by Yamaha, even if sold and installed by a Yamaha dealer.

### **Aftermarket Parts, Accessories, and Modifications**

While you may find aftermarket products similar in design and quality to genuine Yamaha accessories, recognize that some aftermarket accessories or modifications are not suitable because of potential safety hazards to you or others. Installing aftermarket products or having other modifications performed to your vehicle that change any of the vehicle's design or operation characteristics can put you and others at greater risk of serious injury or death. You are responsible for injuries related to changes in the vehicle.

Keep the following guidelines in mind, as well as those provided under "Loading" when mounting accessories.

- Never install accessories or carry cargo that would impair the performance of your motorcycle. Carefully inspect the accessory before

using it to make sure that it does not in any way reduce ground clearance or cornering clearance, limit suspension travel, steering travel or control operation, or obscure lights or reflectors.

- Accessories fitted to the handlebar or the front fork area can create instability due to improper weight distribution or aerodynamic changes. If accessories are added to the handlebar or front fork area, they must be as lightweight as possible and should be kept to a minimum.
- Bulky or large accessories may seriously affect the stability of the motorcycle due to aerodynamic effects. Wind may attempt to lift the motorcycle, or the motorcycle may become unstable in cross winds. These accessories may also cause instability when passing or being passed by large vehicles.
- Certain accessories can displace the operator from his or her normal riding position. This improper position limits the free-

dom of movement of the operator and may limit control ability, therefore, such accessories are not recommended.

- Use caution when adding electrical accessories. If electrical accessories exceed the capacity of the motorcycle's electrical system, an electric failure could result, which could cause a dangerous loss of lights or engine power.

### **Aftermarket Tires and Rims**

The tires and rims that came with your motorcycle were designed to match the performance capabilities and to provide the best combination of handling, braking, and comfort. Other tires, rims, sizes, and combinations may not be appropriate. See page 7-17 for tire specifications and for information on servicing and replacing your tires.

### **Transporting the Motorcycle**

Be sure to observe following instructions before transporting the motorcycle in another vehicle.

- Remove all loose items from the motorcycle.

## Safety information

---

1

- Check that the fuel cock (if equipped) is in the off position and that there are no fuel leaks.
- Shift the transmission into gear (for models with a manual transmission).
- Secure the motorcycle with tie-downs or suitable straps that are attached to solid parts of the motorcycle, such as the frame or upper front fork triple clamp (and not, for example, to rubber-mounted handlebars or turn signals, or parts that could break). Choose the location for the straps carefully so the straps will not rub against painted surfaces during transport.
- The suspension should be compressed somewhat by the tie-downs, if possible, so that the motorcycle will not bounce excessively during transport.



## Left view

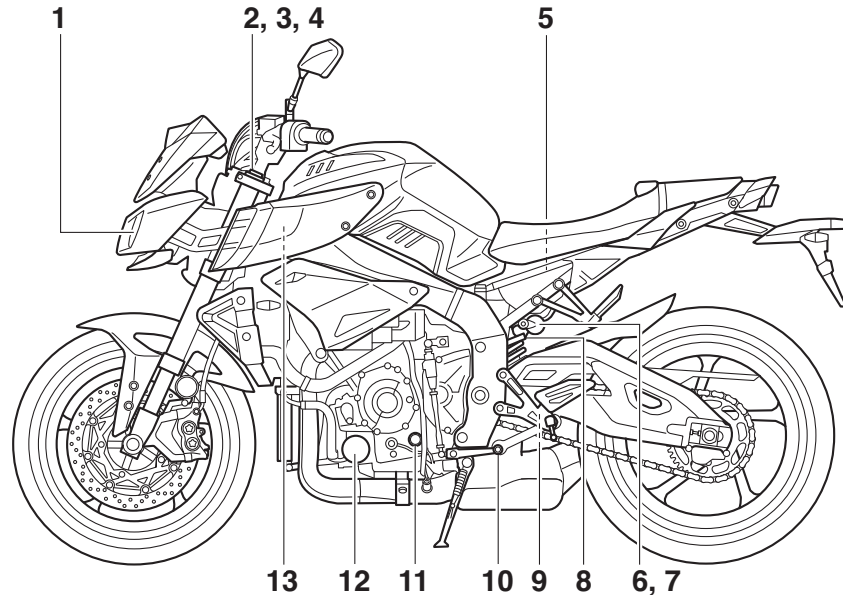

1. Headlight (page 7-33)
2. Spring preload adjuster (page 4-22)
3. Rebound damping force adjuster (page 4-22)
4. Compression damping force adjuster (page 4-22)
5. Battery (page 7-29)
6. Fast compression damping force adjuster (page 4-24)
7. Slow compression damping force adjuster (page 4-24)
8. Spring preload adjuster (page 4-24)
9. Rebound damping force adjuster (page 4-24)
10. Shift pedal (page 4-16)
11. Engine oil level check window (page 7-10)
12. Engine oil filter cartridge (page 7-10)
13. Fuses (page 7-30)

# Description

EAU10421

## Right view

2

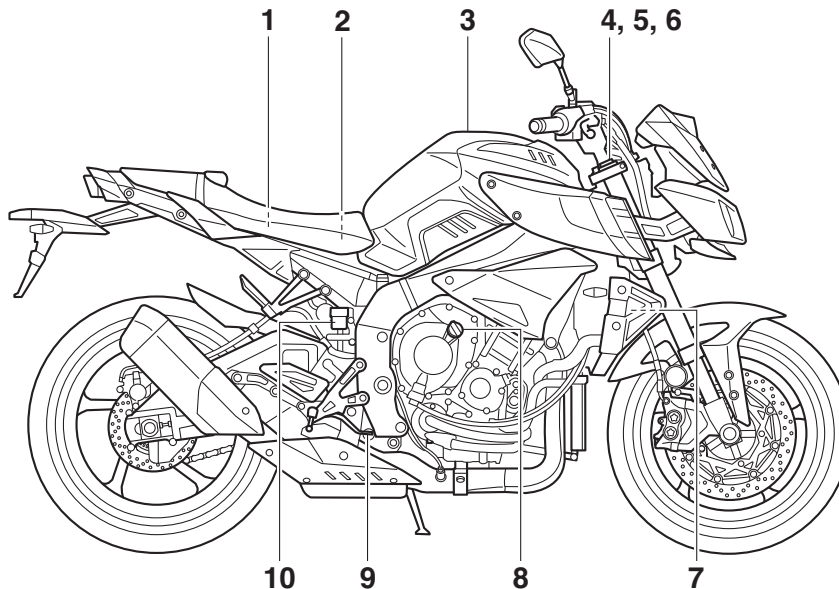

1. Fuses (page 7-30)

2. Tool kit (page 7-2)

3. Fuel tank cap (page 4-18)

4. Spring preload adjuster (page 4-22)

5. Rebound damping force adjuster (page 4-22)

6. Compression damping force adjuster (page 4-22)

7. Coolant reservoir (page 7-14)

8. Engine oil filler cap (page 7-10)

9. Brake pedal (page 4-17)

10. Rear brake fluid reservoir (page 7-22)

## Controls and instruments

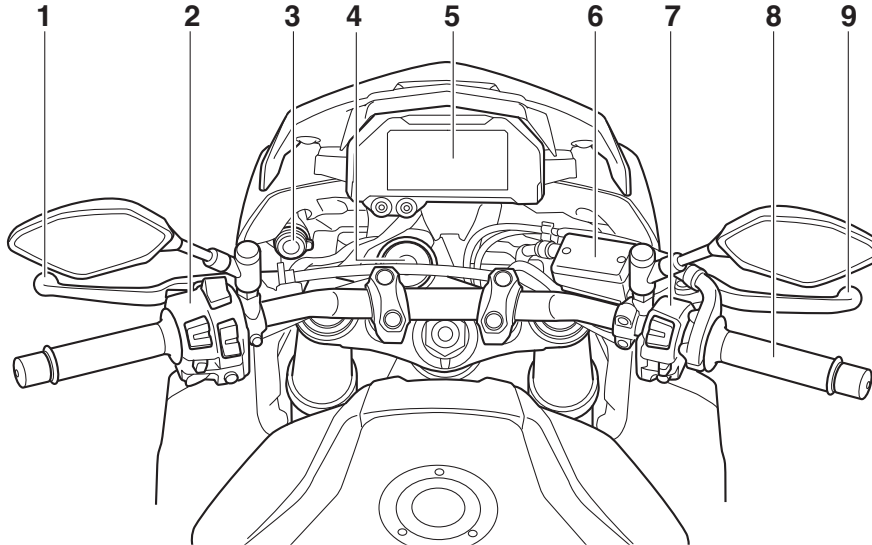

1. Clutch lever (page 4-16)
2. Left handlebar switches (page 4-3)
3. Auxiliary DC jack (page 4-27)
4. Main switch/steering lock (page 4-2)
5. Multi-function meter unit (page 4-8)
6. Front brake fluid reservoir (page 7-22)
7. Right handlebar switches (page 4-3)
8. Throttle grip (page 7-16)

9. Brake lever (page 4-16)

# Special features

3

## Cruise control system



This model is equipped with a cruise control system designed to maintain a set cruising speed.

The cruise control system operates only when riding in 4th, 5th or 6th gear at speeds between about 50 km/h (31 mi/h) and 180 km/h (112 mi/h).

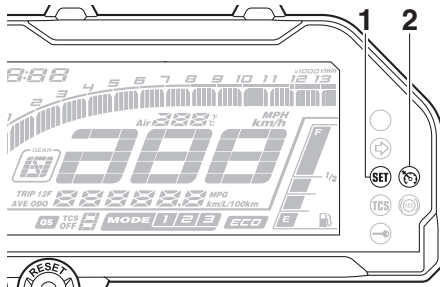

EUA74041

EWA16341

### ⚠ WARNING

- **Improper use of the cruise control system may result in loss of control, which could lead to an accident. Do not activate the cruise control system in heavy traffic, poor weather conditions, or among winding, slippery, hilly, rough or gravel roads.**
- **When traveling uphill or downhill, the cruise control system may not be able to maintain the set cruising speed.**
- **To prevent accidentally activating the cruise control system, turn it off when not in use. Make sure that the cruise control system indicator light “

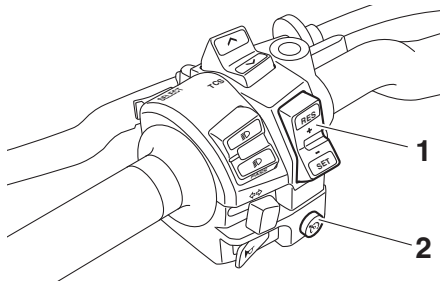
A line drawing of a motorcycle instrument cluster. The speedometer is at the top with a needle and a scale from 0 to 120 km/h. Below it, the odometer and trip meter are visible. The gear indicator shows '4th' gear. The cruise control system is indicated by a 'SET' indicator light and a 'RES+' indicator light. A 'RESET' button is located at the bottom left of the cluster.**

1. Cruise control setting indicator light “SET”
2. Cruise control system indicator light “

A line drawing of the cruise control switch located on the left handlebar. The switch has two main sections: a top section with 'RES+' and 'SET-' buttons, and a bottom section with a power switch labeled 'CC ON/OFF'. A 'RESET' button is also visible on the side of the switch.

1. Cruise control setting switch “RES+/SET-”
2. Cruise control power switch “

## Activating and setting the cruise control system

1. Push the cruise control power

switch “

2. Push the “SET-” side of the cruise control setting switch to activate the cruise control system. Your current traveling speed will become the set cruising speed. The cruise control setting indicator light “SET” will come on.

## Adjusting the set cruising speed

While the cruise control system is operating, push the “RES+” side of the cruise control setting switch to increase the set cruising speed or the “SET-” side to decrease the set speed.

### TIP

Pushing the setting switch once will change the speed in increments of approximately 2.0 km/h (1.2 mi/h). Holding the “RES+” or “SET-” side of the cruise control setting switch down will increase or decrease the speed continuously until the switch is released.

You can also manually increase your traveling speed using the throttle. After you have accelerated, you can set a

new cruising speed by pushing the “SET-” side of the setting switch. If you do not set a new cruising speed, when you return the throttle grip, the vehicle will decelerate to the previously set cruising speed.

## Deactivating the cruise control system

Perform one of the following operations to cancel the set cruising speed. The “SET” indicator light will go off.

- Turn the throttle grip past the closed position in the deceleration direction.

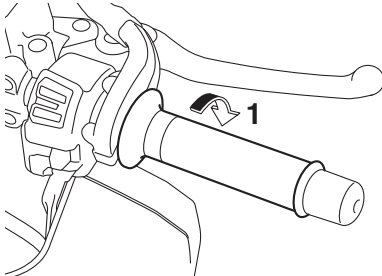

1. Deceleration direction

- Apply the front or rear brake.
- Disengage the clutch.

Push the power switch to turn off the cruise control system. The “RES” indicator light and the “SET” indicator light will go off.

### TIP

Traveling speed decreases as soon as the cruise control system is deactivated; unless the throttle grip is turned.

## Using the resume function

Push the “RES+” side of the cruise control setting switch to reactivate the cruise control system. The traveling speed will return to the previously set cruising speed. The “SET” indicator light will come on.

EWA16351

### **⚠ WARNING**

**It is dangerous to use the resume function when the previously set cruising speed is too high for current conditions.**

### TIP

Pushing the power switch while the system is operating will turn the system off completely and erase the previously set cruising speed. You will not be able

to use the resume function until a new cruising speed has been set.



## Automatic deactivation of the cruise control system

The cruise control system for this model is electronically controlled and is linked with the other control systems. The cruise control system will automatically become deactivated under the following conditions:

- The cruise control system is not able to maintain the set cruising speed.
- Wheel slip or wheel spin is detected. (If the traction control system has not been turned off, the traction control system will work.)
- The start/engine stop switch is set to the “” position.
- The engine stalls.
- The sidestand is lowered.

When traveling with a set cruising speed, if the cruise control system is deactivated under the above conditions, the “RES” indicator light will go off and the “SET” indicator light will flash for 4 seconds, and then go off.

## Special features

When not traveling with a set cruising speed, if the start/engine stop switch is set to the “” position, the engine stalls, or the sidestand is lowered, then the “” indicator light will go off (the “SET” indicator light will not flash).

If the cruise control system is automatically deactivated, please stop and confirm that your vehicle is in good operating condition.

Before using the cruise control system again, activate it using the power switch.

### TIP

In some cases, the cruise control system may not be able to maintain the set cruising speed when the vehicle is traveling uphill or downhill.

- When the vehicle is traveling uphill, the actual traveling speed may become lower than the set cruising speed. If this occurs, accelerate to the desired traveling speed using the throttle.
- When the vehicle is traveling downhill, the actual traveling speed may become higher than the set cruising speed. If this oc-

curs, the setting switch cannot be used to adjust the set cruising speed. To reduce the traveling speed, apply the brakes. When the brakes are applied, the cruise control system will become deactivated.

EAU74053

## D-mode (drive mode)

D-mode is an electronically-controlled engine performance system. Select mode 1 for the most aggressive throttle response, mode 2 for standard throttle grip/engine response, and use mode 3 for rainy days or whenever less engine power is desirable.

EWA18440

### WARNING

**Do not change the drive mode while the vehicle is moving.**

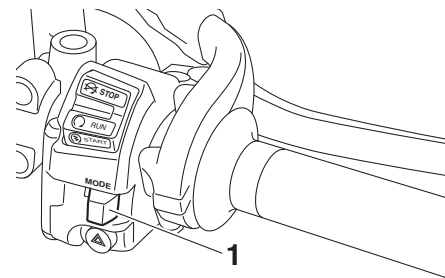

1. Drive mode switch “MODE”

With the throttle grip closed, push the “MODE” switch to change the drive mode.

## TIP

- The current drive mode is shown in the drive mode display (page 4-11).
- The current drive mode is saved when the vehicle is turned off.

## Traction control system

EAU73914

The traction control system (TCS) helps maintain traction when accelerating on slippery surfaces, such as unpaved or wet roads. If sensors detect that the rear wheel is starting to slip (uncontrolled spinning), the traction control system assists by regulating engine power as needed until traction is restored.

EWA15433

## WARNING

**The traction control system is not a substitute for riding appropriately for the conditions. Traction control cannot prevent loss of traction due to excessive speed when entering turns, when accelerating hard at a sharp lean angle, or while braking, and cannot prevent front wheel slipping. As with any vehicle, approach surfaces that may be slippery with caution and avoid especially slippery surfaces.**

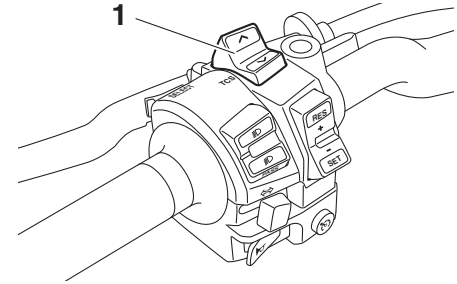

1. Traction control system switch "TCS"

With the throttle closed, push this switch down to change from TCS "1" or "2" to "3". Push up to change from TCS "3" or "2" to "1".

With the vehicle stopped, push this switch up for two seconds to turn the system off. Push down to turn the system on.

## TIP

The current TCS setting is shown in the TCS display (page 4-11).

# Special features

3

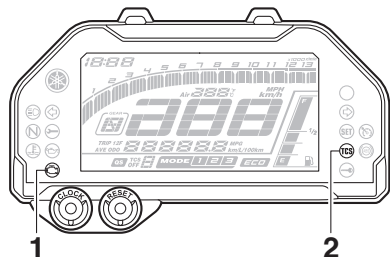

1. Engine trouble warning light “”
2. Traction control system indicator light “TCS”

The “TCS” indicator light flashes when traction control has engaged. You may notice slight changes in engine and exhaust sounds when the system has engaged.

In certain conditions, the traction control system may be automatically disabled. Should this happen, both the “TCS” indicator light and the “” warning light will come on.

The TCS display (page 4-11) indicates the current TCS setting. There are four settings.

## TCS “OFF”

TCS “OFF” turns the traction control

system off.

## TCS “1”

TCS “1” minimizes traction control system assist. Select this mode for sporty riding.

## TCS “2”

TCS “2” provides a moderate level of traction control assist. Select this mode for standard street riding.

## TCS “3”

TCS “3” maximizes traction control assist; wheel spin is most strongly controlled. Select this mode for rain, slippery road conditions, and whenever maximum traction control is desirable.

## TIP

- Traction control can be turned on or off only when the vehicle is stopped.
- When the key is turned to “ON”, traction control is turned on and set to TCS “1”, “2” or “3” (whichever was last selected).
- Turn the traction control system off to help free the rear wheel if the ve-

hicle gets stuck in mud, sand, or other soft surfaces.

ECA16801

## NOTICE

**Use only the specified tires. (See page 7-17.) Using different sized tires will prevent the traction control system from controlling tire rotation accurately.**

## Resetting the traction control system

The traction control system will automatically disable when:

- the front wheel or rear wheel comes off the ground while riding.
- excessive rear wheel spin is detected while riding.
- either wheel is rotated with the key turned to “ON” (such as when performing maintenance).

If the traction control system is disabled, both the “TCS” indicator light and the “” warning light will come on. Should this occur, try resetting the system as follows.

1. Stop the vehicle and turn the key to “OFF”.



2. Wait a few seconds and then turn the key back to “ON”.
3. The “TCS” indicator light should turn off and the system be enabled.

**TIP** \_\_\_\_\_

If the “TCS” indicator light remains on after resetting, the vehicle may still be ridden; however, have a Yamaha dealer check the vehicle as soon as possible.

4. Have a Yamaha dealer check the vehicle and turn off the “” warning light.

EAU79481

## Quick shift system

The quick shift system allows for full-throttle, clutch lever-less upshifts. When the shift switch detects motion in the shift pedal, engine power and drive torque are momentarily adjusted to allow the upshift to occur.

**TIP** \_\_\_\_\_

The quick shift system operates when traveling at least 20 km/h (12 mi/h) with an engine speed of 2000 r/min or higher, and only when accelerating. It does not operate when the clutch lever is pulled.

ECA26260

**NOTICE** \_\_\_\_\_

**To prevent drivetrain damage, always use the clutch lever to shift when riding at slow speed, when downshifting, or if the quick shift system is off.**

# Instrument and control functions

## Immobilizer system

EAU10979

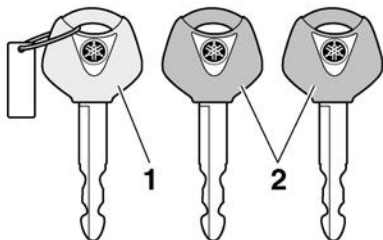

1. Code re-registering key (red bow)
2. Standard keys (black bow)

This vehicle is equipped with an immobilizer system to help prevent theft by re-registering codes in the standard keys. This system consists of the following:

- a code re-registering key
- two standard keys
- a transponder (in each key)
- an immobilizer unit (on the vehicle)
- an ECU (on the vehicle)
- a system indicator light (page 4-7)

### About the keys

The key with the red bow is used to register codes in each standard key. Store

the code re-registering key in a safe place. When necessary, take the vehicle along with all three keys to a Yamaha dealer to have them re-registered.

Do not use the key with the red bow for driving. It should only be used for re-registering the standard keys. Always use a standard key for driving.

### TIP

- Keep the standard keys as well as keys of other immobilizer systems away from the code re-registering key.
- Keep other immobilizer system keys away from the main switch as they may cause signal interference.

ECA11823

### NOTICE

**DO NOT LOSE THE CODE RE-REGISTERING KEY! CONTACT YOUR DEALER IMMEDIATELY IF IT IS LOST! If the code re-registering key is lost, the existing standard keys can still be used to start the vehicle. However, registering a new standard key is impossible. If all keys**

**have been lost or damaged, the entire immobilizer system must be replaced. Therefore, handle the keys carefully.**

- **Do not submerge in water.**
- **Do not expose to high temperatures.**
- **Do not place near magnets.**
- **Do not place near items that transmit electrical signals.**
- **Do not handle roughly.**
- **Do not grind or alter.**
- **Do not disassemble.**
- **Do not put two keys of any immobilizer system on the same key ring.**

## Main switch/steering lock

EAU10474

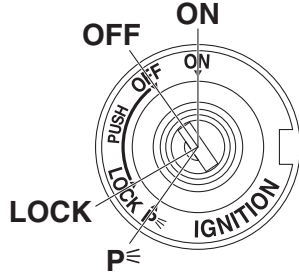

The main switch/steering lock controls the ignition and lighting systems, and is used to lock the steering. The various positions are described below.

### TIP

Be sure to use the standard key (black bow) for regular use of the vehicle. To minimize the risk of losing the code re-registering key (red bow), keep it in a safe place and only use it for code re-registering.

EAU74111

### ON

All electrical circuits are supplied with power. The meter lighting, taillight, li-

cense plate light and auxiliary light come on, and the engine can be started. The key cannot be removed.

### TIP

The headlights come on automatically when the engine is started and stay on until the key is turned to "OFF", even if the engine stalls.

EAU10662

### OFF

All electrical systems are off. The key can be removed.

EWA10062

### **⚠ WARNING**

**Never turn the key to "OFF" or "LOCK" while the vehicle is moving. Otherwise the electrical systems will be switched off, which may result in loss of control or an accident.**

EAU1068B

### LOCK

The steering is locked and all electrical systems are off. The key can be removed.

## To lock the steering

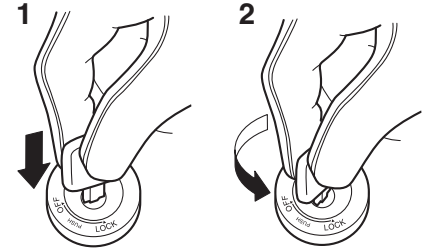

1. Push.
2. Turn.

1. Turn the handlebars all the way to the left.
2. With the key in the "OFF" position, push the key in and turn it to "LOCK".
3. Remove the key.

### TIP

If the steering will not lock, try turning the handlebars back to the right slightly.

# Instrument and control functions

## To unlock the steering

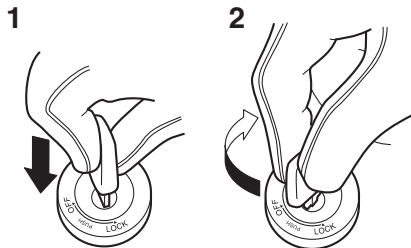

1. Push.
2. Turn.

From the “LOCK” position, push the key in and turn it to “OFF”.

EAU65680

## **p** (Parking)

The hazard lights can be turned on, but all other electrical systems are off. The key can be removed.

The steering must be locked before the key can be turned to “p”.

ECA22330

## **NOTICE**



Using the hazard lights for an extended length of time may cause the battery to discharge.

## Handlebar switches

EAU66055

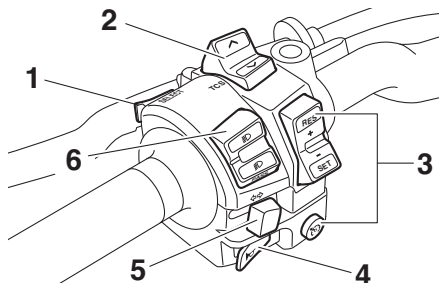

### Left



1. Select switch “SELECT”
2. Traction control system switch “TCS”
3. Cruise control switches
4. Horn switch “”
5. Turn signal switch “/”
6. Dimmer/Pass switch “/”

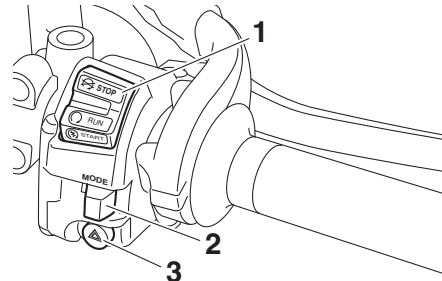

### Right



1. Stop/Run/Start switch “/”
2. Drive mode switch “MODE”
3. Hazard switch “”

EAU73922

## Dimmer/Pass switch “/”

Set this switch to “” for the high beam and to “” for the low beam.



To flash the high beam, push the pass side “PASS” of the switch while the headlights are on low beam.

## TIP

When the switch is set to low beam, only the left headlight bulb comes on. When the switch is set to high beam, both headlights come on.

## Turn signal switch “”

EAU66040

To signal a right-hand turn, push this switch to “”. To signal a left-hand turn, push this switch to “”. When released, the switch returns to the center position. To cancel the turn signal lights, push the switch in after it has returned to the center position.

## Horn switch “”

EAU66030

Press this switch to sound the horn.



## Traction control system switch “TCS”

EAU73961

See page 3-4 for an explanation of the traction control system.

## Stop/Run/Start switch “”

EAU66060

To crank the engine with the starter, set this switch to “”, and then push the switch down towards “”. See page 6-1 for starting instructions prior to starting the engine.

Set this switch to “” to stop the engine in case of an emergency, such as when the vehicle overturns or when the throt-

tle cable is stuck.

## Hazard switch “”

EAU66010

With the key in the “ON” or “” position, use this switch to turn on the hazard lights (simultaneous flashing of all turn signal lights).

The hazard lights are used in case of an emergency or to warn other drivers when your vehicle is stopped where it might be a traffic hazard.

### **NOTICE**

**Do not use the hazard lights for an extended length of time with the engine not running, otherwise the battery may discharge.**

## Cruise control switches

See page 3-1 for an explanation of the cruise control system.

## “SELECT” switch

This switch is used to perform selections in the odometer, tripmeters, coolant temperature and air temperature

display of the multi-function meter unit. (See page 4-8.)

## Drive mode switch “MODE”

See page 3-3 for an explanation of the drive mode.









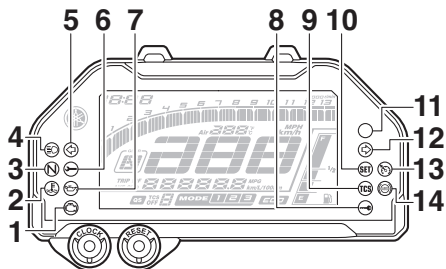

EAU73931

# Instrument and control functions

## Indicator lights and warning lights

EAU4939G



1. Engine trouble warning light “”
2. Coolant temperature warning light “”
3. Neutral indicator light “**N**”
4. High beam indicator light “”
5. Left turn signal indicator light “”
6. Steering damper warning light “”
7. Oil pressure warning light “”
8. Immobilizer system indicator light “”
9. Traction control system indicator light “**TCS**”
10. Cruise control setting indicator light “**SET**”
11. Shift indicator light
12. Right turn signal indicator light “”
13. Cruise control system indicator light “”
14. ABS warning light “”

### Turn signal indicator lights “” and “”

EAU11032

Each indicator light will flash when its corresponding turn signal lights are flashing.

### Neutral indicator light “**N**”

EAU11061

This indicator light comes on when the transmission is in the neutral position.

### High beam indicator light “”

EAU11081

This indicator light comes on when the high beam of the headlight is switched on.

### Oil pressure warning light “”

EAU59962

This warning light comes on if the engine oil pressure is low.

The electrical circuit of the warning light can be checked by turning the key to “ON”. The warning light should come on again after going off briefly, and then remain on until the engine is started.

If the warning light does not come on initially when the key is turned to “ON”, have a Yamaha dealer check the elec-

trical circuit.

ECA21210

### **NOTICE**

If the warning light comes on when the engine is running, stop the engine immediately and check oil level. If the oil level is below the minimum level, add sufficient oil of the recommended type to raise it up to the correct level. If the oil pressure warning light remains on even if the oil level is correct, immediately turn the engine off and have a Yamaha dealer check the vehicle.

### **TIP**

If the warning light does not go off after starting the engine, check the engine oil level and add oil if necessary. (See page 7-10.)

If the warning light remains on after adding engine oil, have a Yamaha dealer check the vehicle.

EAU74073

### **Cruise control indicator lights “”/ “**SET**”**

These indicator lights come on when

# Instrument and control functions

the cruise control system is activated. (See page 3-1.)

## TIP

When the vehicle is turned on, these lights should come on for a few seconds and then go off. Otherwise, have a Yamaha dealer check the vehicle.

EAU11448

## Coolant temperature warning light “”

This warning light comes on when the engine is overheating. If this occurs, stop the engine immediately and allow the engine to cool.

When the vehicle is turned on, the light will come on for a few seconds, and then go off. If the light does not come on, or if the light remains on, have a Yamaha dealer check the vehicle.

## TIP

- For vehicles with a radiator fan, the radiator fan(s) automatically switch on or off according to the coolant temperature.
- If the engine overheats, see page 7-36 for further instructions.

ECA10022

## NOTICE

**Do not continue to operate the engine if it is overheating.**

EAU73172

## Engine trouble warning light “”

This warning light comes on if a problem is detected in the engine or other vehicle control system. If this occurs, have a Yamaha dealer check the on-board diagnostic system.

## TIP

When the vehicle is turned on, the light will come on for a few seconds and then go off. If the light does not come on, or if the light remains on, have a Yamaha dealer check the vehicle.

EAU69892

## ABS warning light “”

This warning light comes on when the vehicle is first turned on, and goes off after starting riding. If the warning light comes on while riding, the anti-lock brake system may not work correctly. (See page 4-17.)

## TIP

If the light does not come at all, or if the light does not go off after traveling 10 km/h (6 mi/h), have a Yamaha dealer check the vehicle.

EWA16041

## WARNING

**If the ABS warning light does not go off after traveling at a speed of 10 km/h (6 mi/h) or higher, or if the warning light comes on or flashes while riding, the brake system reverts to conventional braking. If either of the above occurs, or if the warning light does not come on at all, use extra caution to avoid possible wheel lock during emergency braking. Have a Yamaha dealer check the brake system and electrical circuits as soon as possible.**

EAU74082

## Traction control system indicator light “TCS”

This indicator light will flash when traction control has engaged. If the traction control system is turned off, this indicator light will come on.

# Instrument and control functions

---

## TIP

When the vehicle is turned on, the light should come on for a few seconds and then go off. If the light does not come on, or if the light remains on, have a Yamaha dealer check the vehicle.

## TIP

When the vehicle is turned on, the light should come on for a few seconds and then go off. If the light does not come on, or if the light remains on, have a Yamaha dealer check the vehicle.

tor light will flash in a pattern), have a Yamaha dealer check the vehicle.

## TIP

If the immobilizer system indicator light flashes in the pattern, slowly 5 times then quickly 2 times, this could be caused by transponder interference. If this occurs, try the following.

4

EAU74100

### Steering damper warning light “”

This warning light comes on if a problem is detected in the steering damper. If this occurs, have a Yamaha dealer check the vehicle.

The electrical circuit of the warning light can be checked by turning the key to “ON”. The warning light should come on for a few seconds, and then go off. If the warning light does not come on initially when the key is turned to “ON”, or if the warning light remains on, have a Yamaha dealer check the electrical circuit.

EAU74091

### Shift indicator light

This indicator light can be set to come on and go off at select engine speeds. (See page 4-14.)

EAU73120

### Immobilizer system indicator light “”

When the key is turned to “OFF” and 30 seconds have passed, the indicator light will flash steadily to indicate the immobilizer system is enabled. After 24 hours have passed, the indicator light will stop flashing, however the immobilizer system is still enabled.

The electrical circuit of the indicator light can be checked by turning the key to “ON”. The indicator light should come on for a few seconds, and then go off.

If the indicator light does not come on initially when the key is turned to “ON”, if the indicator light remains on, or if the indicator light flashes in a pattern (if a problem is detected in the immobilizer system, the immobilizer system indica-

1. Make sure there are no other immobilizer keys close to the main switch. Other immobilizer system keys may cause signal interference and prevent the engine from starting.
2. Use the code re-registering key to start the engine.
3. If the engine starts, turn it off, and try starting the engine with the standard keys.
4. If one or both of the standard keys do not start the engine, take the vehicle and all 3 keys to a Yamaha dealer to have the standard keys re-registered.



# Instrument and control functions

## Multi-function meter unit

EAU79183

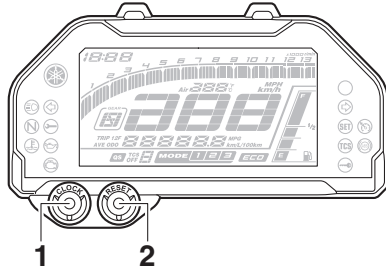

1. "CLOCK" button
2. "RESET" button

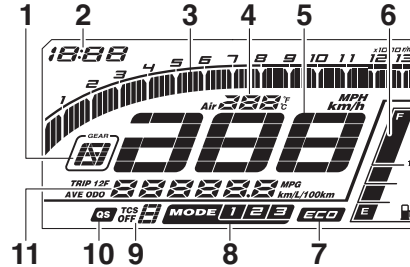

1. Transmission gear display
2. Clock
3. Tachometer
4. Coolant temperature display/air temperature display
5. Speedometer
6. Fuel meter
7. Eco indicator "ECO"
8. Drive mode display
9. TCS display
10. QS indicator
11. Multi-function display

## accident.

The multi-function meter unit is equipped with the following:

- a speedometer
- a tachometer
- a clock
- a fuel meter
- a coolant/air temperature display
- an eco indicator
- a transmission gear display
- a drive mode display
- a TCS display
- a QS indicator
- a multi-function display

## TIP

To switch the multi-function meter unit between kilometers and miles, push the "CLOCK" button and "RESET" button at the same time.

## WARNING

Be sure to stop the vehicle before making any setting changes to the multi-function meter unit. Changing settings while riding can distract the operator and increase the risk of an

EWA12423

# Instrument and control functions

## Speedometer

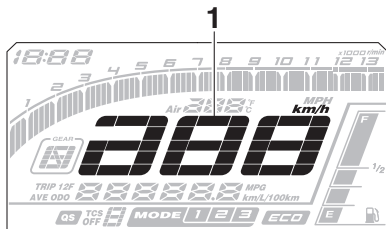

1. Speedometer

The speedometer shows the vehicle's traveling speed.

## Tachometer

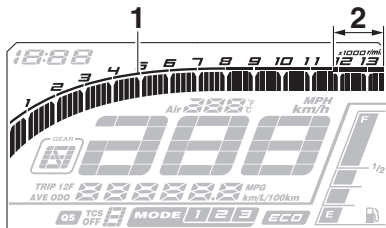

1. Tachometer
2. Tachometer red zone

The tachometer allows the rider to monitor the engine speed and keep it within the ideal power range.

When the key is turned to "ON", the tachometer will sweep across the r/min range and then return to zero r/min in order to test the electrical circuit.

ECA10032

## NOTICE

**Do not operate the engine in the tachometer red zone.**

**Red zone: 11800 r/min and above**

## Clock

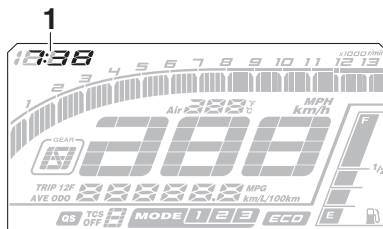

1. Clock

The clock uses a 12-hour time system.

## To set the clock

1. Turn the key to "ON".
2. Push the "CLOCK" button for two seconds.
3. When the hour digits start flashing, push the "RESET" button to set the hours.
4. Push the "CLOCK" button, and the minute digits will start flashing.
5. Push the "RESET" button to set the minutes.
6. Push the "CLOCK" button and then release it to start the clock.

## Fuel meter

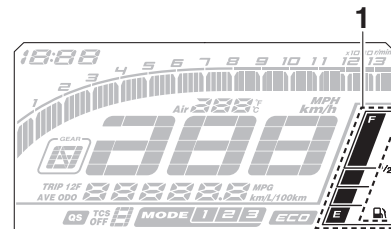

1. Fuel meter

The fuel meter indicates the amount of fuel in the fuel tank. The display seg-

# Instrument and control functions

ments of the fuel meter disappear from “F” (full) towards “E” (empty) as the fuel level decreases. When the last segment starts flashing, refuel as soon as possible.

## TIP

If a problem is detected in the electrical circuit, the fuel level segments and “” will flash repeatedly. If this occurs, have a Yamaha dealer check the vehicle.

## Coolant/Air temperature display

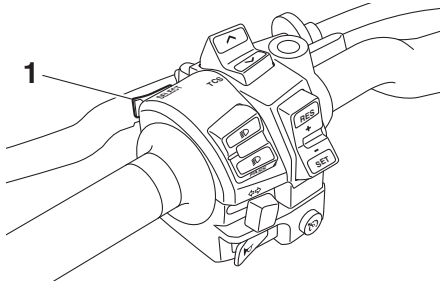

1. Select switch “SELECT”

Push the “SELECT” switch for two seconds to switch the display between the coolant temperature mode “°C” and air temperature mode.

## Coolant temperature

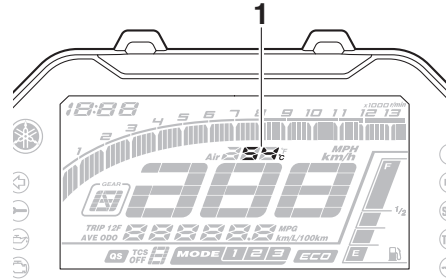

1. Coolant temperature display

This mode shows the coolant temperature from 40 °C to 124 °C in 1 °C increments.

If the message “Hi” flashes, stop the vehicle, then stop the engine, and let the engine cool. (See page 7-36.)

## TIP

- When the coolant temperature is below 40 °C, “Lo” will be displayed.
- The coolant temperature varies with changes in the weather and engine load.

## Air temperature

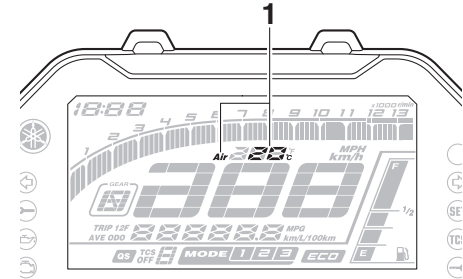

1. Air temperature display

This mode shows the air temperature from –9 °C to 50 °C in 1 °C increments.

## TIP

- –9 °C will be displayed even if the air temperature falls below –9 °C.
- The temperature displayed may vary from the actual ambient temperature.

# Instrument and control functions

## Eco indicator

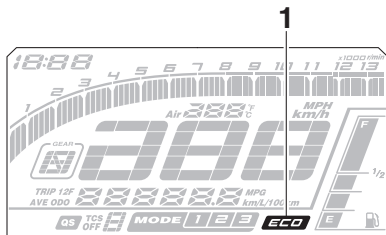

1. Eco indicator “ECO”

This indicator comes on when the vehicle is being operated in an environmentally friendly, fuel-efficient manner. The indicator goes off when the vehicle is stopped.

## TIP

Consider the following tips to reduce fuel consumption:

- Avoid high engine speeds during acceleration.
- Travel at a constant speed.
- Select the transmission gear that is appropriate for the vehicle speed.

## Transmission gear display

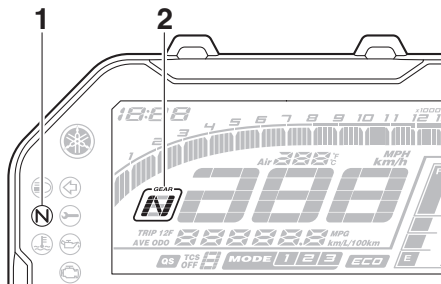

1. Neutral indicator light “N”
2. Transmission gear display

This display shows the selected gear. The neutral position is indicated by “N” and by the neutral indicator light.

## Drive mode display

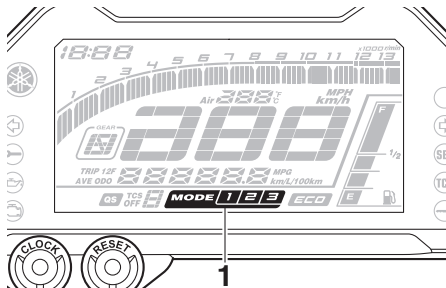

1. Drive mode display

This display indicates which drive mode has been selected: “1”, “2” or “3”. For more details on the modes and on how to select them, see page 3-3.

## TCS display

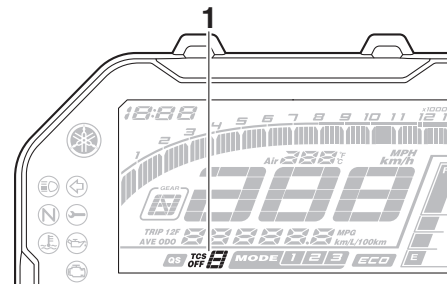

1. TCS display

This display indicates which traction control system setting has been selected: “1”, “2”, “3” or “OFF”. For more details on the TCS settings and how to select them, see page 3-4.

# Instrument and control functions

## QS indicator

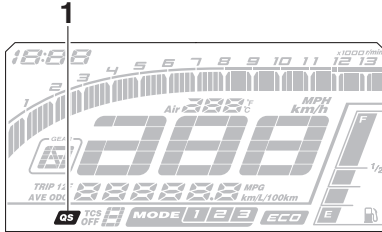

1. QS indicator

When the key is turned to “ON”, the quick shift system (page 3-6) turns on and this indicator comes on.

**TIP**  
If a problem is detected in the quick shift system, this indicator will turn off and the quick shift system will be unavailable. Have a Yamaha dealer check the vehicle.

## Multi-function display

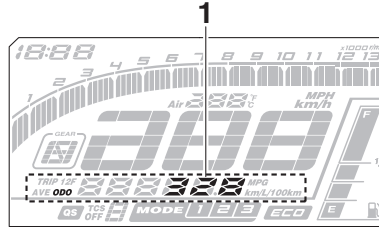

1. Multi-function display

The multi-function display is equipped with the following:

- an odometer (ODO)
- two tripmeters (TRIP 1 and TRIP 2)
- a fuel reserve tripmeter (TRIP F)
- a fuel consumption calculator
- screen brightness and shift indicator light control mode

**TIP**  
● The odometer will lock at 999999.  
● The tripmeters reset and continue counting after 9999.9 is reached.

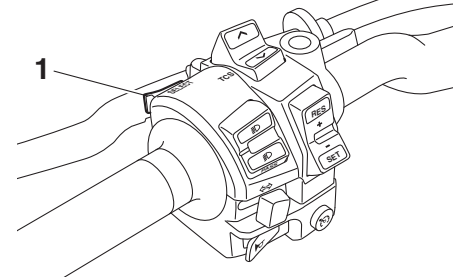

1. Select switch “SELECT”

Push the “SELECT” switch to switch the display between the odometer mode “ODO”, tripmeter modes “TRIP 1” and “TRIP 2”, instantaneous fuel consumption mode “km/L” or “L/100 km”, average fuel consumption mode “AVE --.- km/L” or “AVE --.- L/100 km” in the following order:

ODO → TRIP 1 → TRIP 2 → km/L or L/100 km → AVE --.- km/L or AVE --.- L/100 km → ODO

When set to miles:  
ODO → TRIP 1 → TRIP 2 → MPG → AVE --.- MPG → ODO  
If the last segment of the fuel meter

# Instrument and control functions

starts flashing, the display automatically changes to the fuel reserve tripmeter mode “TRIP F” and starts counting the distance traveled from that point. In this case, push the “SELECT” switch to switch the display in the following order:

TRIP F → km/L or L/100 km → AVE  
--.- km/L or AVE --.- L/100 km →  
ODO → TRIP 1 → TRIP 2 → TRIP F

When set to miles:

TRIP F → MPG → AVE --.- MPG →  
ODO → TRIP 1 → TRIP 2 → TRIP F

## TIP

- To reset a tripmeter, select it by pushing the “SELECT” switch, and then push the “RESET” button for two seconds.
- If you do not reset the fuel reserve tripmeter manually, it resets automatically and disappears after refueling and traveling 5 km (3 mi).

## Instantaneous fuel consumption mode

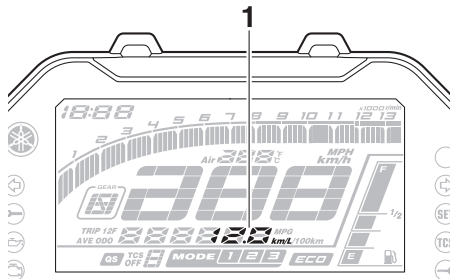

1. Instantaneous fuel consumption display

The instantaneous fuel consumption display can be set to either “km/L”, “L/100 km” or “MPG” (when the multi-function meter unit has been set to miles).

- “km/L”: The distance that can be traveled on 1.0 L of fuel under the current riding conditions is shown.
- “L/100 km”: The amount of fuel necessary to travel 100 km under the current riding conditions is shown.
- “MPG”: The distance that can be traveled on 1.0 Imp.gal of fuel under the current riding conditions is

shown.

To switch between the “km/L” and “L/100 km”, push the “CLOCK” and “RESET” buttons at the same time.

## TIP

If traveling at speeds under 20 km/h (12 mi/h), “--.-” is displayed.

## Average fuel consumption mode

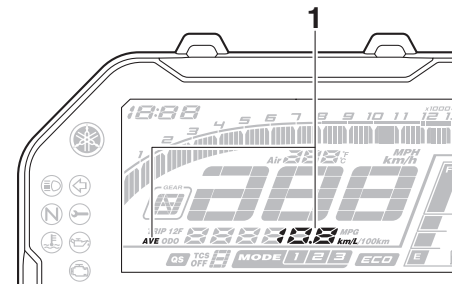

1. Average fuel consumption display

This display shows the average fuel consumption since it was last reset. The average fuel consumption display can be set to either “AVE --.- km/L”, “AVE --.- L/100 km” or “AVE --.- MPG” (when the multi-function meter unit has been set to miles).

# Instrument and control functions

- “AVE – –.– km/L”: The average distance that can be traveled on 1.0 L of fuel is shown.
- “AVE – –.– L/100 km”: The average amount of fuel necessary to travel 100 km is shown.
- “AVE – –.– MPG”: The average distance that can be traveled on 1.0 Imp.gal of fuel is shown.

To switch between the “km/L” and “L/100 km”, push the “CLOCK” and “RESET” buttons at the same time.

To reset the average fuel consumption, push the “RESET” button for two seconds.

## TIP

After resetting the average fuel consumption, “– –.–” will be shown until the vehicle has traveled a sufficient distance.

## Brightness and shift indicator light control mode

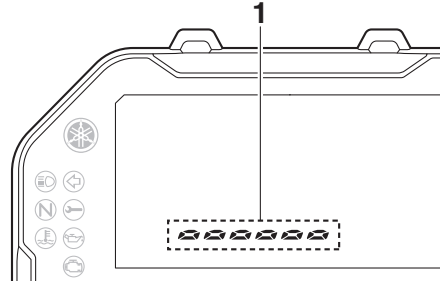

1. Brightness level display

This mode cycles through five control functions, allowing you to make the following settings in the order listed below.

- Screen brightness: This function allows you to adjust the brightness of the screen.
- Shift indicator light style: This function allows you to set the indicator light to on, flash, or off.
- Shift indicator light on r/min: This function allows you to select the engine speed at which the indicator light will be activated.
- Shift indicator light off r/min:

This function allows you to select the engine speed at which the indicator light will be deactivated.

- Shift indicator light brightness: This function allows you to adjust the brightness of the shift indicator light.

## TIP

The brightness level display shows the brightness level setting.

## To adjust the brightness of the screen

1. Turn the key to “OFF”.
2. Push and hold the “CLOCK” button.
3. Turn the key to “ON”, and then release the “CLOCK” button after five seconds.
4. Push the “RESET” button to select the desired brightness level.
5. Push the “CLOCK” button to confirm the selected brightness level. The control mode changes to the shift indicator light style function.

## To set the shift indicator light style

1. Push the “RESET” button to select one of the following style settings:

# Instrument and control functions

---

4

- On - the indicator light will come on when activated. (This setting is selected when the indicator light stays on.)
  - Flash - the indicator light will flash when activated. (This setting is selected when the indicator light flashes four times per second.)
  - Off - the indicator light is deactivated; in other words, it will not come on or flash. (This setting is selected when the indicator light flashes once every two seconds.)
2. Push the “CLOCK” button to confirm the selected indicator light activity. The control mode changes to the shift indicator light on r/min function.

## To set the shift indicator light on r/min

### **TIP**

The shift indicator light can be set between 7000 r/min and 13000 r/min in increments of 200 r/min.

1. Push the “RESET” button to select the desired engine speed for acti-

vating the indicator light.

2. Push the “CLOCK” button to confirm the selected engine speed. The control mode changes to the shift indicator light off r/min function.

## To set the shift indicator light off r/min

### **TIP**

- The shift indicator light can be set between 7000 r/min and 13000 r/min in increments of 200 r/min.
- Be sure to set the off r/min to a higher engine speed than the on r/min setting, otherwise the shift indicator light will not come on.

1. Push the “RESET” button to select the desired engine speed for deactivating the indicator light.
2. Push the “CLOCK” button to confirm the selected engine speed. The control mode changes to the shift indicator light brightness function.

## To adjust the brightness of the shift indicator light

1. Push the “RESET” button to select the desired indicator light brightness level.
2. Push the “CLOCK” button to confirm the selected indicator light brightness level and exit the brightness and shift indicator light control mode.



EAU12822

## Clutch lever

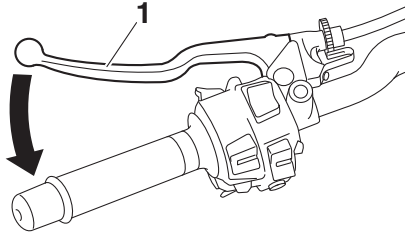

1. Clutch lever

The clutch lever is located on the left side of the handlebar. To disengage the clutch, pull the lever toward the handlebar grip. To engage the clutch, release the lever. The lever should be pulled rapidly and released slowly for smooth clutch operation.

The clutch lever is equipped with a clutch switch, which is part of the ignition circuit cut-off system. (See page 4-29.)

EAU76301

## Shift pedal

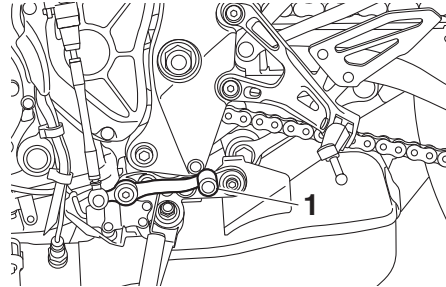

1. Shift pedal

The shift pedal is located on the left side of the motorcycle and is used in combination with the clutch lever when shifting the gears of the 6-speed constant-mesh transmission.

When the quick shift system is turned on, the shift switch senses shift pedal movement and allows for upshifting without operating the clutch lever. (See page 3-6.)

EAU26826

## Brake lever

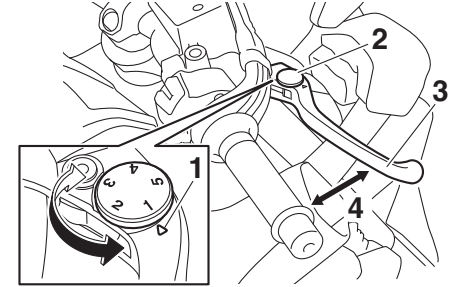

1. Match mark
2. Brake lever position adjusting dial
3. Brake lever
4. Distance between brake lever and throttle grip

The brake lever is located on the right side of the handlebar. To apply the front brake, pull the lever toward the throttle grip.

The brake lever is equipped with a brake lever position adjusting dial. To adjust the distance between the brake lever and the throttle grip, slightly pull the brake lever away from the throttle grip and rotate the adjusting dial. Make sure the setting number on the adjusting dial aligns with the match mark on

# Instrument and control functions

the brake lever.

4

## Brake pedal

EAU12944

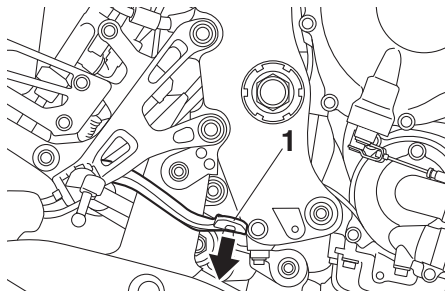

1. Brake pedal

The brake pedal is located on the right side of the motorcycle. To apply the rear brake, press down on the brake pedal.

EAU63040

## ABS

The Yamaha ABS (Anti-lock Brake System) features a dual electronic control system, which acts on the front and rear brakes independently.

Operate the brakes with ABS as you would conventional brakes. If the ABS is activated, a pulsating sensation may be felt at the brake lever or brake pedal. In this situation, continue to apply the brakes and let the ABS work; do not “pump” the brakes as this will reduce braking effectiveness.

EWA16051

### **WARNING**

**Always keep a sufficient distance from the vehicle ahead to match the riding speed even with ABS.**

- **The ABS performs best with long braking distances.**
- **On certain surfaces, such as rough or gravel roads, the braking distance may be longer with the ABS than without.**

The ABS is monitored by an ECU, which will revert the system to conventional braking if a malfunction occurs.

## TIP

- The ABS performs a self-diagnosis test each time the vehicle first starts off after the key is turned to “ON” and the vehicle has traveled at a speed of 10 km/h (6 mi/h) or higher. During this test, a “clicking” noise can be heard from the hydraulic control unit, and if the brake lever or brake pedal is even slightly applied, a vibration can be felt at the lever and pedal, but these do not indicate a malfunction.
- This ABS has a test mode which allows the owner to experience the pulsation at the brake lever or brake pedal when the ABS is operating. However, special tools are required, so please consult your Yamaha dealer.

ECA20100

## NOTICE

**Be careful not to damage the wheel sensor or wheel sensor rotor; otherwise, improper performance of the ABS will result.**

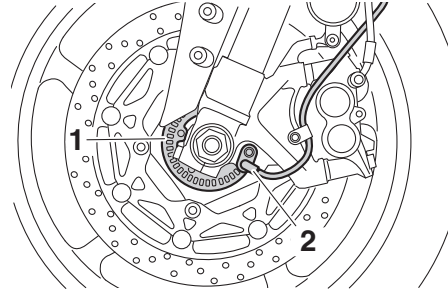

1. Front wheel sensor rotor
2. Front wheel sensor

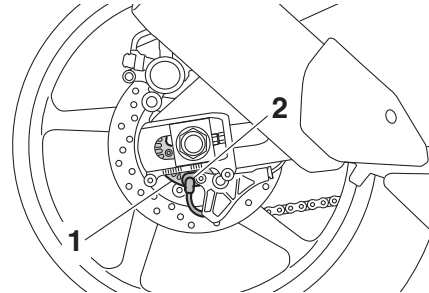

1. Rear wheel sensor rotor
2. Rear wheel sensor

## Fuel tank cap

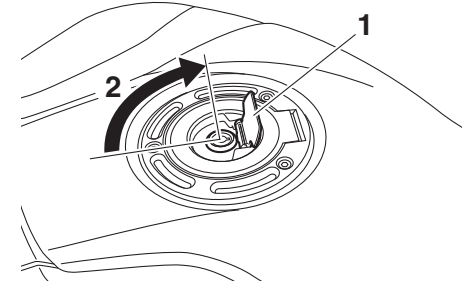

1. Fuel tank cap lock cover
2. Unlock.

## To open the fuel tank cap

Open the fuel tank cap lock cover, insert the key into the lock, and then turn it 1/4 turn clockwise. The lock will be released and the fuel tank cap can be opened.

## To close the fuel tank cap

With the key still inserted in the lock, push down the fuel tank cap. Turn the key 1/4 turn counterclockwise, remove it, and then close the lock cover.

## TIP

The fuel tank cap cannot be closed un-

# Instrument and control functions

less the key is in the lock. In addition, the key cannot be removed if the cap is not properly closed and locked.

EWA11092

## **⚠ WARNING**

Make sure that the fuel tank cap is properly closed after filling fuel. Leaking fuel is a fire hazard.

4

## Fuel

Make sure there is sufficient gasoline in the tank.

EAU13222

EWA10882

## **⚠ WARNING**

Gasoline and gasoline vapors are extremely flammable. To avoid fires and explosions and to reduce the risk of injury when refueling, follow these instructions.

1. Before refueling, turn off the engine and be sure that no one is sitting on the vehicle. Never refuel while smoking, or while in the vicinity of sparks, open flames, or other sources of ignition such as the pilot lights of water heaters and clothes dryers.
2. Do not overfill the fuel tank. When refueling, be sure to insert the pump nozzle into the fuel tank filler hole. Stop filling when the fuel reaches the bottom of the filler tube. Because fuel expands when it heats up, heat from the engine or the sun can cause fuel to spill out of the fuel tank.

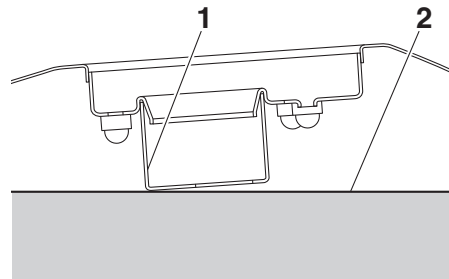

1. Fuel tank filler tube
2. Maximum fuel level
3. Wipe up any spilled fuel immediately. **NOTICE: Immediately wipe off spilled fuel with a clean, dry, soft cloth, since fuel may deteriorate painted surfaces or plastic parts.**<sup>[ECA10072]</sup>
4. Be sure to securely close the fuel tank cap.

EWA15152

## **⚠ WARNING**

Gasoline is poisonous and can cause injury or death. Handle gasoline with care. Never siphon gasoline by mouth. If you should swallow some gasoline or inhale a lot of gasoline vapor, or get some gasoline in

# Instrument and control functions

**your eyes, see your doctor immediately. If gasoline spills on your skin, wash with soap and water. If gasoline spills on your clothing, change your clothes.**

EAU75300

## Recommended fuel:

Premium unleaded gasoline (Gasohol [E10] acceptable)

## Fuel tank capacity:

17 L (4.5 US gal, 3.7 Imp.gal)

## Fuel reserve amount:

4.0 L (1.06 US gal, 0.88 Imp.gal)

ECA11401

## NOTICE

**Use only unleaded gasoline. The use of leaded gasoline will cause severe damage to internal engine parts, such as the valves and piston rings, as well as to the exhaust system.**



## TIP

- This mark identifies the recommended fuel for this vehicle as specified by European regulation (EN228).
- Check that gasoline nozzle has the same identifier when fueling.

Your Yamaha engine has been designed to use premium unleaded gasoline with a research octane number of 95 or higher. If knocking (or pinging) occurs, use a gasoline of a different brand. Use of unleaded fuel will extend spark plug life and reduce maintenance costs.

## Gasohol

There are two types of gasohol: gaso-

hol containing ethanol and that containing methanol. Gasohol containing ethanol can be used if the ethanol content does not exceed 10% (E10). Gasohol containing methanol is not recommended by Yamaha because it can cause damage to the fuel system or vehicle performance problems.

# Instrument and control functions

EAU72972

## Fuel tank overflow hose

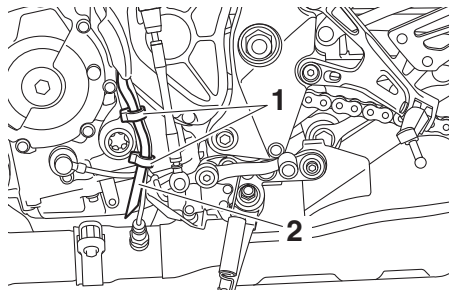

1. Clamp
2. Fuel tank overflow hose

Before operating the vehicle:

- Check the overflow hose connection and for damage.
- Confirm the overflow hose is not blocked and is routed through the clamp.

**TIP** \_\_\_\_\_  
See page 7-10 for canister information.

EAU13434

## Catalytic converter

This model is equipped with a catalytic converter in the exhaust system.

EWA10863

### **WARNING**

The exhaust system is hot after operation. To prevent a fire hazard or burns:

- Do not park the vehicle near possible fire hazards such as grass or other materials that easily burn.
- Park the vehicle in a place where pedestrians or children are not likely to touch the hot exhaust system.
- Make sure that the exhaust system has cooled down before doing any maintenance work.
- Do not allow the engine to idle more than a few minutes. Long idling can cause a build-up of heat.

ECA10702

### **NOTICE**

Use only unleaded gasoline. The use of leaded gasoline will cause unre-

pairable damage to the catalytic converter.

EAU57992

## Seat

### To remove the seat

1. Open the seat lock cover, insert the key into the seat lock, and then turn the key counterclockwise.

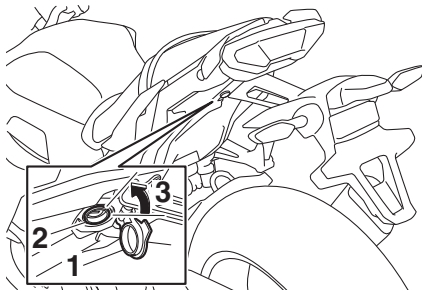

1. Seat lock cover
2. Seat lock
3. Unlock.

2. While holding the key in that position, slide the seat backward and then lift the rear of the seat up, and then pull the seat off.

### To install the seat

1. Insert the projections into the seat holders as shown.

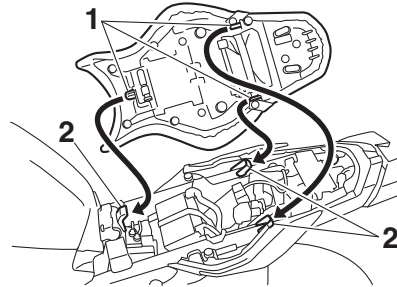

1. Projection
  2. Seat holder
2. Push the rear of the seat down to lock it in place.
  3. Remove the key.

### TIP

Make sure that the seat is properly secured before riding.

EAU70412

## Adjusting the front fork

This model is equipped with adjustable suspension. The spring preload, rebound damping force, and compression damping force of each leg can be adjusted.

EWA10181

### **! WARNING**

**Always adjust both fork legs equally, otherwise poor handling and loss of stability may result.**

ECA22471

### **NOTICE**

- Use extra care to avoid scratching the gold-anodized finish when making suspension adjustments.
- To avoid damaging the suspension's internal mechanisms, do not attempt to turn beyond the maximum or minimum settings.

## Spring preload

To increase the spring preload and thereby harden the suspension, turn the adjusting nut on each fork in direction (a). To decrease the spring preload

# Instrument and control functions

and thereby soften the suspension, turn the adjusting nut on each fork in direction (b).

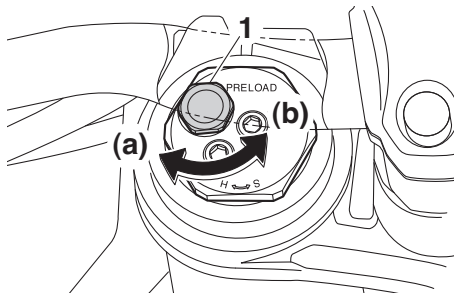

1. Spring preload adjusting nut

## Spring preload setting:

Minimum (soft):

0 turn(s) in direction (a)

Standard:

9 turn(s) in direction (a)

Maximum (hard):

15 turn(s) in direction (a)  
after fully turning in direction (b)

en the rebound damping, turn the adjusting bolt on each fork leg in direction (b).

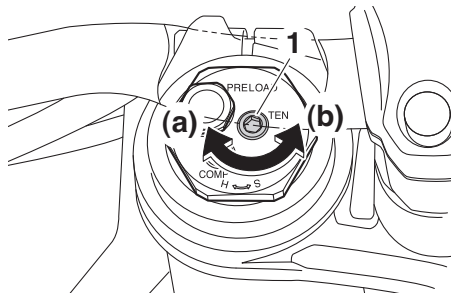

1. Rebound damping force adjusting bolt

## Rebound damping setting:

Minimum (soft):

14 click(s) in direction (b)

Standard:

6 click(s) in direction (b)

Maximum (hard):

1 click(s) in direction (b)  
after fully turning in direction (a)

and thereby soften the compression damping, turn the adjusting bolt on each fork leg in direction (b).

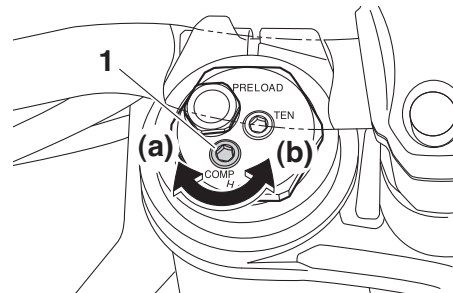

1. Compression damping force adjusting bolt

## Compression damping setting:

Minimum (soft):

23 click(s) in direction (b)

Standard:

17 click(s) in direction (b)

Maximum (hard):

1 click(s) in direction (b)  
after fully turning in direction (a)

## Rebound damping force

To increase the rebound damping force and thereby harden the rebound damping, turn the adjusting bolt on each fork leg in direction (a). To decrease the rebound damping force and thereby soft-

## Compression damping force

To increase the compression damping force and thereby harden the compression damping, turn the adjusting bolt on each fork leg in direction (a). To decrease the compression damping force

## TIP

- When turning a damping force adjuster in direction (a), the 0 click position and the 1 click position may be the same.
- Although a damping force adjuster



may turn or click beyond the stated minimum settings, such adjustments are ineffective and may damage the suspension.

EAU74241

## Adjusting the shock absorber assembly

This model is equipped with adjustable suspension. The spring preload, rebound damping force, fast compression damping force, and slow compression damping force can be adjusted.

ECA10102

### NOTICE

**To avoid damaging the mechanism, do not attempt to turn beyond the maximum or minimum settings.**

## Spring preload

1. Loosen the locknut.
2. To increase the spring preload and thereby harden the suspension, turn the adjusting ring in direction (a). To decrease the spring preload and thereby soften the suspension, turn the adjusting ring in direction (b).

The spring preload setting is determined by measuring distance A. The longer distance A is, the higher the spring preload; the shorter

distance A is, the lower the spring preload.

- Use the special wrench included in the additional tool kit to make the adjustment.

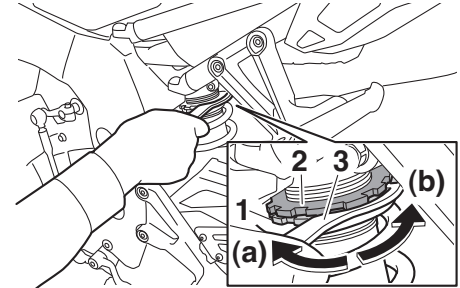

1. Spring preload adjusting ring
2. Locknut
3. Special wrench

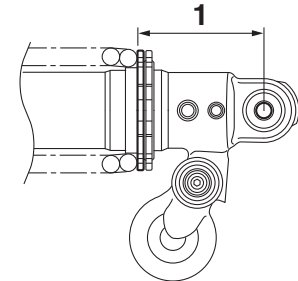

1. Distance A

# Instrument and control functions

## Spring preload:

Minimum (soft):

Distance A = 77.5 mm (3.05 in)

Standard:

Distance A = 81.5 mm (3.21 in)

Maximum (hard):

Distance A = 85.5 mm (3.37 in)

- 4
3. Tighten the locknut to the specified torque. **NOTICE: Always tighten the locknut against the adjusting ring, and then tighten the locknut to the specified torque.**<sup>[ECA22760]</sup>

## Tightening torque:

Locknut:

25 N·m (2.5 kgf·m, 18 lb·ft)

## Rebound damping force

To increase the rebound damping force and thereby harden the rebound damping, turn the adjusting screw in direction (a). To decrease the rebound damping force and thereby soften the rebound damping, turn the adjusting screw in direction (b).

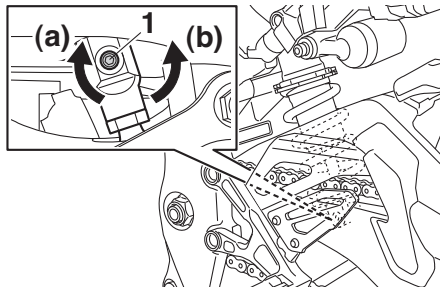

1. Rebound damping force adjusting screw

## Rebound damping setting:

Minimum (soft):

23 click(s) in direction (b)\*

Standard:

11 click(s) in direction (b)\*

Maximum (hard):

1 click(s) in direction (b)\*

\* With the adjusting screw fully turned in direction (a)

## Compression damping force

### Fast compression damping force

To increase the compression damping force and thereby harden the fast compression damping, turn the adjusting bolt in direction (a). To decrease the compression damping force and there-

by soften the compression damping, turn the adjusting bolt in direction (b).

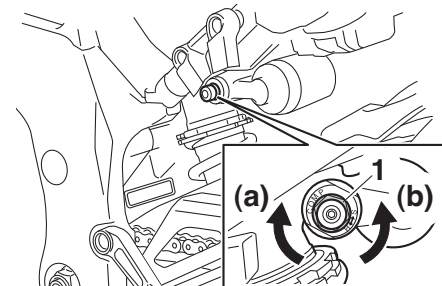

1. Fast compression damping force adjusting bolt

## Fast compression damping setting

Minimum (soft):

5.5 turn(s) in direction (b)\*

Standard:

3 turn(s) in direction (b)\*

Maximum (hard):

0 turn(s) in direction (b)\*

\* With the adjusting bolt fully turned in direction (a)

### Slow compression damping force

To increase the compression damping force and thereby harden the slow compression damping, turn the adjusting screw in direction (a). To decrease

# Instrument and control functions

the compression damping force and thereby soften the compression damping, turn the adjusting screw in direction (b).

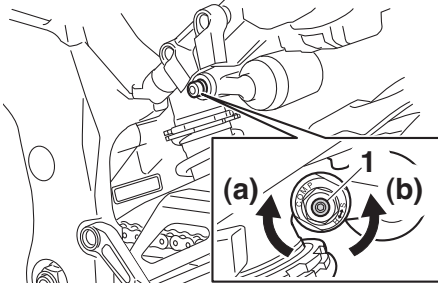

1. Slow compression damping force adjusting screw

## Slow compression damping setting

Minimum (soft):

18 click(s) in direction (b)\*

Standard:

12 click(s) in direction (b)\*

Maximum (hard):

1 click(s) in direction (b)\*

\* With the adjusting screw fully turned in direction (a)

## TIP

- When turning a damping force adjuster in direction (a), the 0 click position and the 1 click position

may be the same.

- Although a damping force adjuster may turn or click beyond the stated minimum settings, such adjustments are ineffective and may damage the suspension.

EWA10222

## ! WARNING

This shock absorber assembly contains highly pressurized nitrogen gas. Read and understand the following information before handling the shock absorber assembly.

- Do not tamper with or attempt to open the cylinder assembly.
- Do not subject the shock absorber assembly to an open flame or other high heat source. This may cause the unit to explode due to excessive gas pressure.
- Do not deform or damage the cylinder in any way. Cylinder damage will result in poor damping performance.
- Do not dispose of a damaged or worn-out shock absorber assembly yourself. Take the shock

absorber assembly to a Yamaha dealer for any service.

# Instrument and control functions

## Luggage strap holders

EAU15152

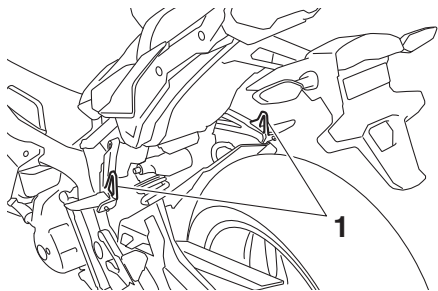

1. Luggage strap holder

There is a luggage strap holder on each passenger footrest.

## EXUP system

EAU67050

This model is equipped with Yamaha's EXUP (EXhaust Ultimate Power valve) system. This system boosts engine power by means of a valve that controls exhaust flow within the exhaust chamber.

### **NOTICE**

**The EXUP system has been set and extensively tested at the Yamaha factory. Changing these settings without sufficient technical knowledge may result in poor performance of or damage to the engine.**

ECA15611

## Auxiliary DC jack

EAU49454

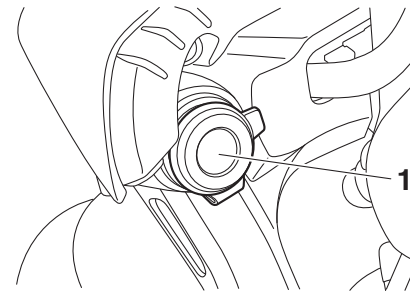

1. Auxiliary DC jack cap

A 12-V accessory connected to the auxiliary DC jack can be used when the main switch is on.

ECA15432

### **NOTICE**

**The accessory connected to the auxiliary DC jack should not be used with the engine turned off, and the load must never exceed 12 W (1.0 A), otherwise the fuse may blow or the battery may discharge.**

### **To use the auxiliary DC jack**

1. Turn the main switch off.
2. Remove the auxiliary DC jack cap.

3. Turn the accessory off.
4. Insert the accessory plug into the auxiliary DC jack.

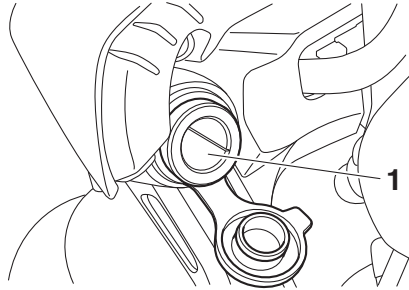

1. Auxiliary DC jack

5. Turn the main switch on, and start the engine. (See page 6-1.)
6. Turn the accessory on.

EWA14361

## WARNING

To prevent electrical shock or short-circuiting, make sure that the cap is installed when the auxiliary DC jack is not being used.

EAU15306

## Sidestand

The sidestand is located on the left side of the frame. Raise the sidestand or lower it with your foot while holding the vehicle upright.

## TIP

The built-in sidestand switch is part of the ignition circuit cut-off system, which cuts the ignition in certain situations. (See the following section for an explanation of the ignition circuit cut-off system.)

EWA10242

## WARNING

The vehicle must not be ridden with the sidestand down, or if the sidestand cannot be properly moved up (or does not stay up), otherwise the sidestand could contact the ground and distract the operator, resulting in a possible loss of control. Yamaha's ignition circuit cut-off system has been designed to assist the operator in fulfilling the responsibility of raising the sidestand before starting off. Therefore, check this system regularly and have a

**Yamaha dealer repair it if it does not function properly.**

# Instrument and control functions

---

EAU57952

## Ignition circuit cut-off system

This system prevents in-gear engine starts unless the clutch lever is pulled and the sidestand is up. Also, it will stop the running engine should the sidestand be lowered while the transmission is in gear.

4

Periodically check this system via the following procedure.

### TIP

---

- This check is most reliable if performed with a warmed-up engine.
  - See pages 4-2 and 4-3 for switch operation information.
-

# Instrument and control functions

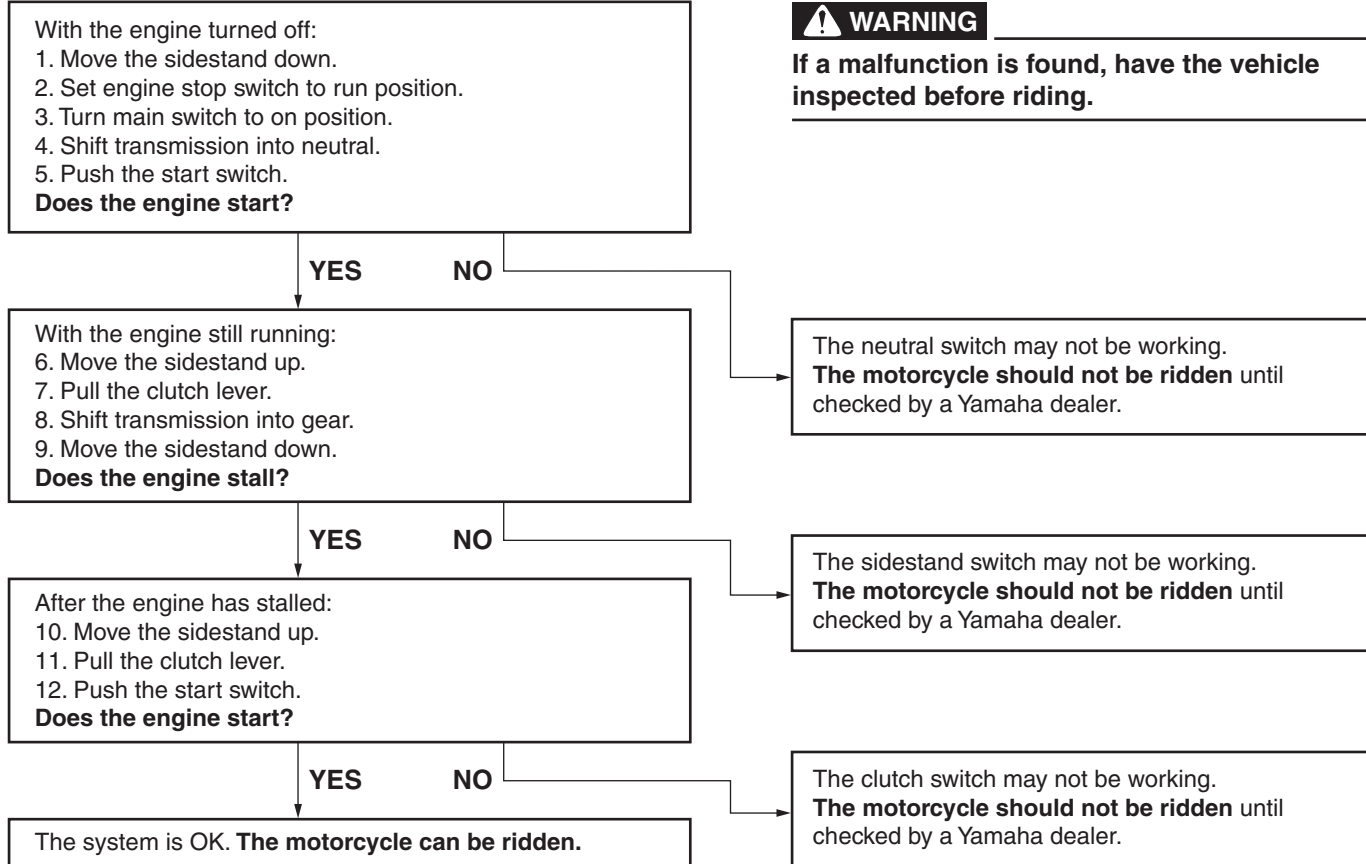

# For your safety – pre-operation checks

EAU15599

Inspect your vehicle each time you use it to make sure the vehicle is in safe operating condition. Always follow the inspection and maintenance procedures and schedules described in the Owner's Manual.

EWA11152

## **WARNING**

**Failure to inspect or maintain the vehicle properly increases the possibility of an accident or equipment damage. Do not operate the vehicle if you find any problem. If a problem cannot be corrected by the procedures provided in this manual, have the vehicle inspected by a Yamaha dealer.**

Before using this vehicle, check the following points:

5

ITEM	CHECKS	PAGE
Fuel	<ul style="list-style-type: none"><li>• Check fuel level in fuel tank.</li><li>• Refuel if necessary.</li><li>• Check fuel line for leakage.</li><li>• Check fuel tank breather/overflow hose for obstructions, cracks or damage, and check hose connection.</li></ul>	4-19, 4-21
Engine oil	<ul style="list-style-type: none"><li>• Check oil level in engine.</li><li>• If necessary, add recommended oil to specified level.</li><li>• Check vehicle for oil leakage.</li></ul>	7-10
Coolant	<ul style="list-style-type: none"><li>• Check coolant level in reservoir.</li><li>• If necessary, add recommended coolant to specified level.</li><li>• Check cooling system for leakage.</li></ul>	7-14
Front brake	<ul style="list-style-type: none"><li>• Check operation.</li><li>• If soft or spongy, have Yamaha dealer bleed hydraulic system.</li><li>• Check brake pads for wear.</li><li>• Replace if necessary.</li><li>• Check fluid level in reservoir.</li><li>• If necessary, add specified brake fluid to specified level.</li><li>• Check hydraulic system for leakage.</li></ul>	7-21, 7-22



# For your safety – pre-operation checks

ITEM	CHECKS	PAGE
<b>Rear brake</b>	<ul style="list-style-type: none"> <li>• Check operation.</li> <li>• If soft or spongy, have Yamaha dealer bleed hydraulic system.</li> <li>• Check brake pads for wear.</li> <li>• Replace if necessary.</li> <li>• Check fluid level in reservoir.</li> <li>• If necessary, add specified brake fluid to specified level.</li> <li>• Check hydraulic system for leakage.</li> </ul>	7-21, 7-22
<b>Clutch</b>	<ul style="list-style-type: none"> <li>• Check operation.</li> <li>• Lubricate cable if necessary.</li> <li>• Check lever free play.</li> <li>• Adjust if necessary.</li> </ul>	7-19
<b>Throttle grip</b>	<ul style="list-style-type: none"> <li>• Make sure that operation is smooth.</li> <li>• Check throttle grip free play.</li> <li>• If necessary, have Yamaha dealer adjust throttle grip free play and lubricate cable and grip housing.</li> </ul>	7-16, 7-25
<b>Control cables</b>	<ul style="list-style-type: none"> <li>• Make sure that operation is smooth.</li> <li>• Lubricate if necessary.</li> </ul>	7-25
<b>Drive chain</b>	<ul style="list-style-type: none"> <li>• Check chain slack.</li> <li>• Adjust if necessary.</li> <li>• Check chain condition.</li> <li>• Lubricate if necessary.</li> </ul>	7-23, 7-24
<b>Wheels and tires</b>	<ul style="list-style-type: none"> <li>• Check for damage.</li> <li>• Check tire condition and tread depth.</li> <li>• Check air pressure.</li> <li>• Correct if necessary.</li> </ul>	7-17, 7-19
<b>Brake and shift pedals</b>	<ul style="list-style-type: none"> <li>• Make sure that operation is smooth.</li> <li>• Lubricate pedal pivoting points if necessary.</li> </ul>	7-26
<b>Brake and clutch levers</b>	<ul style="list-style-type: none"> <li>• Make sure that operation is smooth.</li> <li>• Lubricate lever pivoting points if necessary.</li> </ul>	7-26
<b>Sidestand</b>	<ul style="list-style-type: none"> <li>• Make sure that operation is smooth.</li> <li>• Lubricate pivot if necessary.</li> </ul>	7-27
<b>Chassis fasteners</b>	<ul style="list-style-type: none"> <li>• Make sure that all nuts, bolts and screws are properly tightened.</li> <li>• Tighten if necessary.</li> </ul>	—

## For your safety – pre-operation checks

---

---

ITEM	CHECKS	PAGE
<b>Instruments, lights, signals and switches</b>	<ul style="list-style-type: none"><li>• Check operation.</li><li>• Correct if necessary.</li></ul>	—
<b>Sidestand switch</b>	<ul style="list-style-type: none"><li>• Check operation of ignition circuit cut-off system.</li><li>• If system is not working correctly, have Yamaha dealer check vehicle.</li></ul>	4-28

Read the Owner's Manual carefully to become familiar with all controls. If there is a control or function you do not understand, ask your Yamaha dealer.

EWA10272

## **WARNING**

**Failure to familiarize yourself with the controls can lead to loss of control, which could cause an accident or injury.**

## **TIP**

This model is equipped with:

- a lean angle sensor. This sensor stops the engine in case of a vehicle turnover. If this happens, the engine trouble warning light will come on, but this is not a malfunction. Turn the vehicle power off and then back on again to cancel the warning light. Failing to do so will prevent the engine from starting even though the engine will crank when pushing the start switch.
- an engine auto-stop system. The engine stops automatically if left idling for 20 minutes. If the engine stops, simply push the start switch to restart the engine.

## **Starting the engine**

In order for the ignition circuit cut-off system to enable starting, one of the following conditions must be met:

- The transmission is in the neutral position.
- The transmission is in gear with the clutch lever pulled and the sidestand up.  
See page 4-29 for more information.

1. Turn the key to "ON" and make sure that the stop/run/start switch is set to "○".

The following warning lights and indicator lights should come on for a few seconds, then go off.

- Oil pressure warning light
- Engine trouble warning light
- Coolant temperature warning light
- Shift indicator light
- Steering damper warning light
- Traction control system indicator light
- Cruise control indicator lights
- Immobilizer system indicator light

# Operation and important riding points

ECA11834

## NOTICE

If a warning or indicator light does not come on initially when the key is turned to “ON”, or if a warning or indicator light remains on, see page 4-5 for the corresponding warning and indicator light circuit check.

The ABS warning light should come on when the key is turned to “ON”, and then go off after traveling at a speed of 10 km/h (6 mi/h) or higher.

ECA17682

## NOTICE

If the ABS warning light does not come on and then go off as explained above, see page 4-5 for the warning light circuit check.

2. Shift the transmission into the neutral position. The neutral indicator light should come on. If not, ask a Yamaha dealer to check the electrical circuit.
3. Start the engine by pushing the “(⊖)” side of the stop/run/start switch.

If the engine fails to start, release

the stop/run/start switch, wait a few seconds, and then try again. Each starting attempt should be as short as possible to preserve the battery. Do not crank the engine more than 10 seconds on any one attempt.

ECA11043

## NOTICE

For maximum engine life, never accelerate hard when the engine is cold!

EAU77401

## Shifting

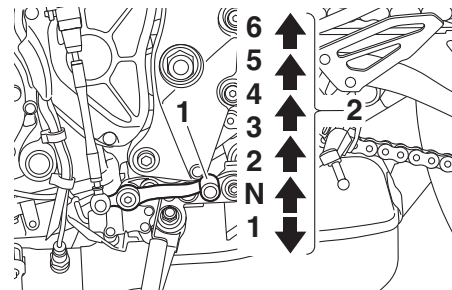

1. Shift pedal
2. Gear positions

Shifting gears lets you control the amount of engine power available for starting off, accelerating, climbing hills, etc. The gear positions are shown in the illustration.

## TIP

- To shift the transmission into the neutral position (N), press the shift pedal down repeatedly until it reaches the end of its travel, and then slightly raise it.
- This model is equipped with a quick shift system. (See page 3-6.)

## NOTICE

- Even with the transmission in the neutral position, do not coast for long periods of time with the engine off, and do not tow the motorcycle for long distances. The transmission is properly lubricated only when the engine is running. Inadequate lubrication may damage the transmission.
- Except when upshifting with the quick shift system, always use the clutch while changing gears to avoid damaging the engine, transmission, and drive train, which are not designed to withstand the shock of forced shifting.

## Tips for reducing fuel consumption

Fuel consumption depends largely on your riding style. Consider the following tips to reduce fuel consumption:

- Shift up swiftly, and avoid high engine speeds during acceleration.
- Do not rev the engine while shifting down, and avoid high engine speeds with no load on the engine.
- Turn the engine off instead of letting it idle for an extended length of time (e.g., in traffic jams, at traffic lights or at railroad crossings).

## Engine break-in

There is never a more important period in the life of your engine than the period between 0 and 1600 km (1000 mi). For this reason, you should read the following material carefully.

Since the engine is brand new, do not put an excessive load on it for the first 1600 km (1000 mi). The various parts in the engine wear and polish themselves to the correct operating clearances. During this period, prolonged full-throttle operation or any condition that might result in engine overheating must be avoided.

### 0–1000 km (0–600 mi)

Avoid prolonged operation above 5900 r/min. **NOTICE: After 1000 km (600 mi) of operation, the engine oil must be changed and the oil filter cartridge or element replaced.**<sup>[ECA10303]</sup>

### 1000–1600 km (600–1000 mi)

Avoid prolonged operation above 7100

# Operation and important riding points

---

r/min.

## 1600 km (1000 mi) and beyond

The vehicle can now be operated normally.

ECA10311

### NOTICE

- Keep the engine speed out of the tachometer red zone.
- If any engine trouble should occur during the engine break-in period, immediately have a Yamaha dealer check the vehicle.

### TIP

During and after the engine break-in period, the exhaust heat may cause discoloration of the exhaust pipe, but this is normal.

EAU17214

## Parking

When parking, stop the engine, and then remove the key from the main switch.

EWA10312

### WARNING

- Since the engine and exhaust system can become very hot, park in a place where pedestrians or children are not likely to touch them and be burned.
- Do not park on a slope or on soft ground, otherwise the vehicle may overturn, increasing the risk of a fuel leak and fire.
- Do not park near grass or other flammable materials which might catch fire.

# Periodic maintenance and adjustment

EAU17246

EWA15123

EAU17303

Periodic inspection, adjustment, and lubrication will keep your vehicle in the safest and most efficient condition possible. Safety is an obligation of the vehicle owner/operator. The most important points of vehicle inspection, adjustment, and lubrication are explained on the following pages.

The intervals given in the periodic maintenance charts should be simply considered as a general guide under normal riding conditions. However, depending on the weather, terrain, geographical location, and individual use, the maintenance intervals may need to be shortened.

## WARNING

EWA10322

**Failure to properly maintain the vehicle or performing maintenance activities incorrectly may increase your risk of injury or death during service or while using the vehicle. If you are not familiar with vehicle service, have a Yamaha dealer perform service.**

## WARNING

**Turn off the engine when performing maintenance unless otherwise specified.**

- **A running engine has moving parts that can catch on body parts or clothing and electrical parts that can cause shocks or fires.**
- **Running the engine while servicing can lead to eye injury, burns, fire, or carbon monoxide poisoning – possibly leading to death. See page 1-2 for more information about carbon monoxide.**

EWA15461

## WARNING

**Brake discs, calipers, drums, and linings can become very hot during use. To avoid possible burns, let brake components cool before touching them.**

Emission controls not only function to ensure cleaner air, but are also vital to proper engine operation and maximum performance. In the following periodic maintenance charts, the services related to emissions control are grouped separately. These services require specialized data, knowledge, and equipment. Maintenance, replacement, or repair of the emission control devices and systems may be performed by any repair establishment or individual that is certified (if applicable). Yamaha dealers are trained and equipped to perform these particular services.

# Periodic maintenance and adjustment

---

## Tool kit

EAU73411

ence required for a particular job, have your Yamaha dealer perform it for you.

---

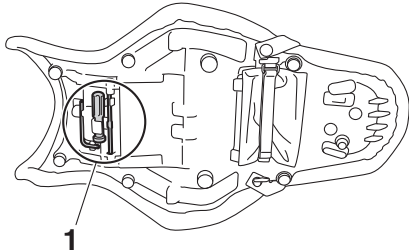

### 1. Tool kit

The tool kit is located on the bottom of the seat. (See page 4-22.)

Also, an additional tool kit was handed out separately at the time of vehicle purchase.

The information included in this manual and the tools provided in the tool kit are intended to assist you in the performance of preventive maintenance and minor repairs. However, a torque wrench and other tools are necessary to perform certain maintenance work correctly.

### **TIP** \_\_\_\_\_

If you do not have the tools or experi-



# Periodic maintenance and adjustment

EAU71033

## Periodic maintenance charts

### TIP

- Items marked with an asterisk should be performed by your Yamaha dealer because these items require special tools, data, and technical skills.
- From 50000 km (30000 mi), repeat the maintenance intervals starting from 10000 km (6000 mi).
- **The annual checks must be performed every year, except if a distance-based maintenance is performed instead.**

EAU71051

## Periodic maintenance chart for the emission control system

NO.	ITEM	CHECK OR MAINTENANCE JOB	ODOMETER READING					ANNUAL CHECK
			1000 km (600 mi)	10000 km (6000 mi)	20000 km (12000 mi)	30000 km (18000 mi)	40000 km (24000 mi)	
1	* Fuel line	<ul style="list-style-type: none"> <li>• Check fuel hoses for cracks or damage.</li> <li>• Replace if necessary.</li> </ul>		√	√	√	√	√
2	* Spark plugs	<ul style="list-style-type: none"> <li>• Check condition.</li> <li>• Adjust gap and clean.</li> </ul>		√		√		
		<ul style="list-style-type: none"> <li>• Replace.</li> </ul>			√		√	
3	* Valve clearance	<ul style="list-style-type: none"> <li>• Check and adjust.</li> </ul>	Every 40000 km (24000 mi)					
4	* Fuel injection	<ul style="list-style-type: none"> <li>• Check engine idle speed.</li> </ul>	√	√	√	√	√	√
		<ul style="list-style-type: none"> <li>• Check and adjust synchronization.</li> </ul>		√	√	√	√	√
5	* Exhaust system	<ul style="list-style-type: none"> <li>• Check for leakage.</li> <li>• Tighten if necessary.</li> <li>• Replace gaskets if necessary.</li> </ul>	√	√	√	√	√	
6	* Evaporative emission control system	<ul style="list-style-type: none"> <li>• Check control system for damage.</li> <li>• Replace if necessary.</li> </ul>			√		√	

# Periodic maintenance and adjustment

NO.	ITEM	CHECK OR MAINTENANCE JOB	ODOMETER READING					ANNUAL CHECK
			1000 km (600 mi)	10000 km (6000 mi)	20000 km (12000 mi)	30000 km (18000 mi)	40000 km (24000 mi)	
7	* <b>Air induction system</b>	<ul style="list-style-type: none"> <li>• Check the air cut-off valve, reed valve, and hose for damage.</li> <li>• Replace any damaged parts if necessary.</li> </ul>		√	√	√	√	√

# Periodic maintenance and adjustment

EAU71352

## General maintenance and lubrication chart

NO.	ITEM	CHECK OR MAINTENANCE JOB	ODOMETER READING					ANNUAL CHECK
			1000 km (600 mi)	10000 km (6000 mi)	20000 km (12000 mi)	30000 km (18000 mi)	40000 km (24000 mi)	
1	* Diagnostic system check	<ul style="list-style-type: none"> <li>Perform dynamic inspection using Yamaha diagnostic tool.</li> <li>Check the error codes.</li> </ul>	√	√	√	√	√	√
2	* Air filter element	<ul style="list-style-type: none"> <li>Replace.</li> </ul>	Every 40000 km (24000 mi)					
3	Clutch	<ul style="list-style-type: none"> <li>Check operation.</li> <li>Adjust.</li> </ul>	√	√	√	√	√	
4	* Front brake	<ul style="list-style-type: none"> <li>Check operation, fluid level, and for fluid leakage.</li> <li>Replace brake pads if necessary.</li> </ul>	√	√	√	√	√	√
5	* Rear brake	<ul style="list-style-type: none"> <li>Check operation, fluid level, and for fluid leakage.</li> <li>Replace brake pads if necessary.</li> </ul>	√	√	√	√	√	√
6	* Brake hoses	<ul style="list-style-type: none"> <li>Check for cracks or damage.</li> </ul>		√	√	√	√	√
		<ul style="list-style-type: none"> <li>Replace.</li> </ul>	Every 4 years					
7	* Brake fluid	<ul style="list-style-type: none"> <li>Change.</li> </ul>	Every 2 years					
8	* Wheels	<ul style="list-style-type: none"> <li>Check runout and for damage.</li> <li>Replace if necessary.</li> </ul>		√	√	√	√	
9	* Tires	<ul style="list-style-type: none"> <li>Check tread depth and for damage.</li> <li>Replace if necessary.</li> <li>Check air pressure.</li> <li>Correct if necessary.</li> </ul>		√	√	√	√	√
10	* Wheel bearings	<ul style="list-style-type: none"> <li>Check bearing for looseness or damage.</li> </ul>		√	√	√	√	
11	* Swingarm pivot bearings	<ul style="list-style-type: none"> <li>Check operation and for excessive play.</li> </ul>		√	√	√	√	
		<ul style="list-style-type: none"> <li>Lubricate with lithium-soap-based grease.</li> </ul>	Every 50000 km (30000 mi)					

# Periodic maintenance and adjustment

NO.	ITEM	CHECK OR MAINTENANCE JOB	ODOMETER READING					ANNUAL CHECK
			1000 km (600 mi)	10000 km (6000 mi)	20000 km (12000 mi)	30000 km (18000 mi)	40000 km (24000 mi)	
12	Drive chain	<ul style="list-style-type: none"> <li>• Check chain slack, alignment and condition.</li> <li>• Adjust and lubricate chain with a special O-ring chain lubricant thoroughly.</li> </ul>	Every 1000 km (600 mi) and after washing the motorcycle, riding in the rain or riding in wet areas					
13	* Steering bearings	<ul style="list-style-type: none"> <li>• Check bearing assemblies for looseness.</li> </ul>	√	√		√		
		<ul style="list-style-type: none"> <li>• Moderately repack with lithium-soap-based grease.</li> </ul>			√		√	
14	* Steering damper	<ul style="list-style-type: none"> <li>• Check operation and for oil leakage.</li> </ul>		√	√	√	√	
15	* Chassis fasteners	<ul style="list-style-type: none"> <li>• Make sure that all nuts, bolts and screws are properly tightened.</li> </ul>		√	√	√	√	√
16	Brake lever pivot shaft	<ul style="list-style-type: none"> <li>• Lubricate with silicone grease.</li> </ul>		√	√	√	√	√
17	Brake pedal pivot shaft	<ul style="list-style-type: none"> <li>• Lubricate with lithium-soap-based grease.</li> </ul>		√	√	√	√	√
18	Clutch lever pivot shaft	<ul style="list-style-type: none"> <li>• Lubricate with lithium-soap-based grease.</li> </ul>		√	√	√	√	√
19	Shift pedal pivot shaft	<ul style="list-style-type: none"> <li>• Lubricate with lithium-soap-based grease.</li> </ul>		√	√	√	√	√
20	Sidestand	<ul style="list-style-type: none"> <li>• Check operation.</li> <li>• Lubricate with lithium-soap-based grease.</li> </ul>		√	√	√	√	√
21	* Sidestand switch	<ul style="list-style-type: none"> <li>• Check operation and replace if necessary.</li> </ul>	√	√	√	√	√	√
22	* Front fork	<ul style="list-style-type: none"> <li>• Check operation and for oil leakage.</li> <li>• Replace if necessary.</li> </ul>		√	√	√	√	
23	* Shock absorber assembly	<ul style="list-style-type: none"> <li>• Check operation and for oil leakage.</li> <li>• Replace if necessary.</li> </ul>		√	√	√	√	

# Periodic maintenance and adjustment

NO.	ITEM	CHECK OR MAINTENANCE JOB	ODOMETER READING					ANNUAL CHECK
			1000 km (600 mi)	10000 km (6000 mi)	20000 km (12000 mi)	30000 km (18000 mi)	40000 km (24000 mi)	
24	* Rear suspension relay arm and connecting arm pivoting points	<ul style="list-style-type: none"> <li>• Check operation.</li> </ul>		√	√	√	√	
25	Engine oil	<ul style="list-style-type: none"> <li>• Change (warm engine before draining).</li> <li>• Check oil level and vehicle for oil leakage.</li> </ul>	√	√	√	√	√	√
26	Engine oil filter cartridge	<ul style="list-style-type: none"> <li>• Replace.</li> </ul>	√		√		√	
27	* Cooling system	<ul style="list-style-type: none"> <li>• Check coolant level and vehicle for coolant leakage.</li> <li>• Change.</li> </ul>		√	√	√	√	√
28	* EXUP system	<ul style="list-style-type: none"> <li>• Check operation, cable free play and pulley position.</li> </ul>	√		√		√	
29	* Front and rear brake switches	<ul style="list-style-type: none"> <li>• Check operation.</li> </ul>	√	√	√	√	√	√
30	* Moving parts and cables	<ul style="list-style-type: none"> <li>• Lubricate.</li> </ul>		√	√	√	√	√
31	* Throttle grip housing and cable	<ul style="list-style-type: none"> <li>• Check operation and free play.</li> <li>• Adjust the throttle cable free play if necessary.</li> <li>• Lubricate the throttle grip housing and cable.</li> </ul>		√	√	√	√	√
32	* Lights, signals and switches	<ul style="list-style-type: none"> <li>• Check operation.</li> <li>• Adjust headlight beam.</li> </ul>	√	√	√	√	√	√

# Periodic maintenance and adjustment

---

EAU72800

## TIP

---

- Air filter
    - This model's air filter is equipped with a disposable oil-coated paper element, which must not be cleaned with compressed air to avoid damaging it.
    - The air filter element needs to be replaced more frequently when riding in unusually wet or dusty areas.
  - Hydraulic brake service
    - Regularly check and, if necessary, correct the brake fluid level.
    - Every two years replace the internal components of the brake master cylinders and calipers, and change the brake fluid.
    - Replace the brake hoses every four years and if cracked or damaged.
-

EAU67110

## Checking the spark plugs

The spark plugs are important engine components, which should be checked periodically, preferably by a Yamaha dealer. Since heat and deposits will cause any spark plug to slowly erode, they should be removed and checked in accordance with the periodic maintenance and lubrication chart. In addition, the condition of the spark plugs can reveal the condition of the engine.

The porcelain insulator around the center electrode of each spark plug should be a medium-to-light tan (the ideal color when the vehicle is ridden normally), and all spark plugs installed in the engine should have the same color. If any spark plug shows a distinctly different color, the engine could be operating improperly. Do not attempt to diagnose such problems yourself. Instead, have a Yamaha dealer check the vehicle.

If a spark plug shows signs of electrode erosion and excessive carbon or other deposits, it should be replaced.

**Specified spark plug:**  
NGK/LMAR9E-J

Before installing a spark plug, the spark plug gap should be measured with a wire thickness gauge and, if necessary, adjusted to specification.

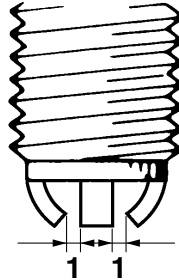

1. Spark plug gap

### Spark plug gap:

0.6–0.7 mm (0.024–0.028 in)

Clean the surface of the spark plug gasket and its mating surface, and then wipe off any grime from the spark plug threads.

### Tightening torque:

Spark plug (new):  
18 N·m (1.8 kgf·m, 13 lb·ft)

Spark plug (after checking):  
13 N·m (1.3 kgf·m, 9.6 lb·ft)

ECA10841

## NOTICE

**Do not use any tools to remove or install the spark plug cap, otherwise the ignition coil coupler may get damaged. The spark plug cap may be difficult to remove because the rubber seal on the end of the cap fits tightly. To remove the spark plug cap, simply twist it back and forth while pulling it out; to install it, twist it back and forth while pushing it in.**

# Periodic maintenance and adjustment

EAU36112

## Canister

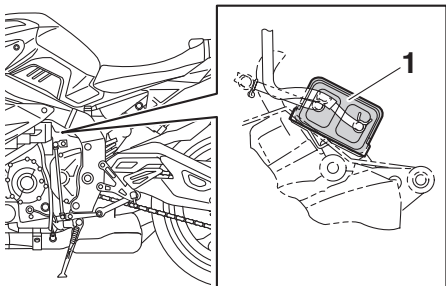

1. Canister

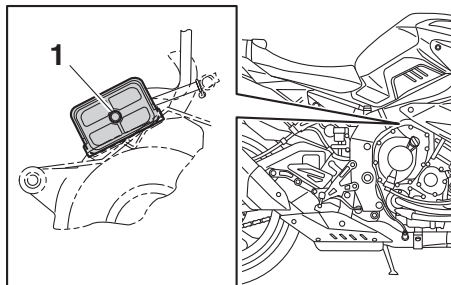

1. Canister breather

This model is equipped with a canister to prevent the discharging of fuel vapor into the atmosphere. Before operating this vehicle, make sure to check the fol-

lowing:

- Check each hose connection.
- Check each hose and canister for cracks or damage. Replace if damaged.
- Make sure that the canister breather is not blocked, and if necessary, clean it.

EAU73973

## Engine oil

The engine oil level should be checked before each ride. In addition, the oil must be changed and the oil filter cartridge replaced at the intervals specified in the periodic maintenance chart.

### Recommended engine oil:

Full synthetic  
10W-40

### Oil quantity:

Oil change:

3.90 L (4.12 US qt, 3.43 Imp.qt)

With oil filter removal:

4.10 L (4.33 US qt, 3.61 Imp.qt)

ECA11621

### NOTICE

- In order to prevent clutch slippage (since the engine oil also lubricates the clutch), do not mix any chemical additives. Do not use oils with a diesel specification of “CD” or oils of a higher quality than specified. In addition, do not use oils labeled “ENERGY CONSERVING II” or higher.
- Make sure that no foreign mate-



# Periodic maintenance and adjustment

rial enters the crankcase.

## To check the engine oil level

1. After warming up the engine, wait a few minutes for the oil level to settle for an accurate reading.
2. With the vehicle on a level surface, hold it upright for an accurate reading.
3. Check the oil level through the check window located at the bottom of the left-side of the crankcase.

## TIP

The engine oil should be between the minimum and maximum level marks.

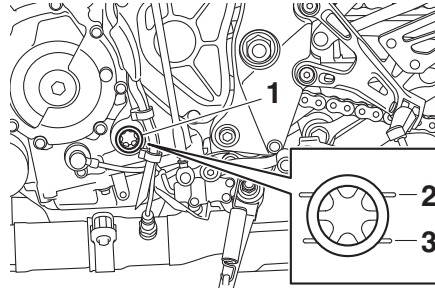

1. Engine oil level check window
  2. Maximum level mark
  3. Minimum level mark
4. If the engine oil is at or below the minimum level mark, remove the oil filler cap and add oil

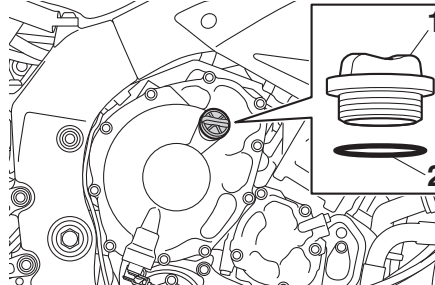

1. Engine oil filler cap
2. O-ring

5. Check the O-ring for damage, and replace if necessary.
6. Install the engine oil filler cap.

## To change the engine oil (and filter)

1. Start the engine, warm it up for several minutes, and then turn it off.
2. Place an oil pan under the engine to collect the used oil.
3. Remove the engine oil filler cap, the engine oil drain bolt and its gasket to drain the oil from the crankcase.

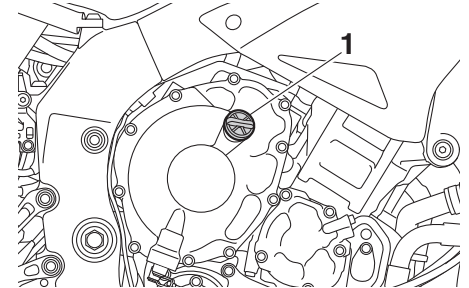

1. Engine oil filler cap

# Periodic maintenance and adjustment

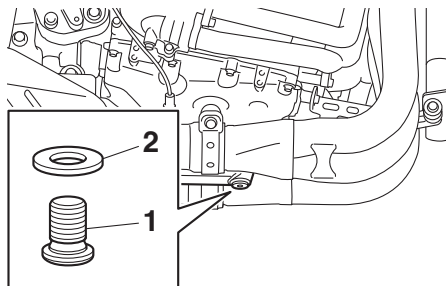

1. Engine oil drain bolt
2. Gasket

**TIP** \_\_\_\_\_  
Skip steps 4–6 if the oil filter cartridge is not being replaced.

4. Remove the oil filter cartridge with an oil filter wrench.

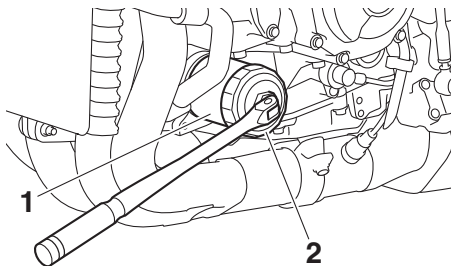

1. Oil filter cartridge
2. Oil filter wrench

**TIP** \_\_\_\_\_  
An oil filter wrench is available at a Yamaha dealer.

5. Apply a thin coat of clean engine oil to the O-ring of the new oil filter cartridge.

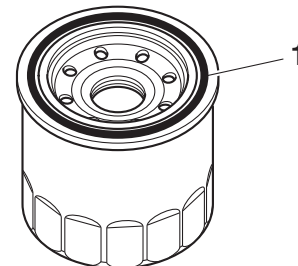

1. O-ring

**TIP** \_\_\_\_\_  
Make sure that the O-ring is properly seated.

6. Install a new oil filter cartridge, and then tighten to the specified torque.

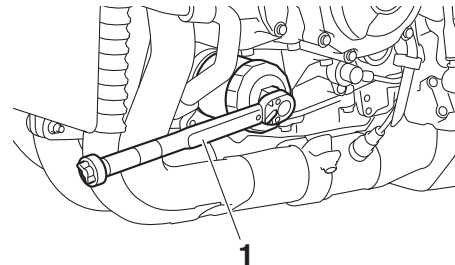

1. Torque wrench

# Periodic maintenance and adjustment

## Tightening torque:

Oil filter cartridge:  
17 N·m (1.7 kgf·m, 13 lb·ft)

7. Install the engine oil drain bolt and its new gasket, and then tighten the bolt to the specified torque.

## Tightening torque:

Engine oil drain bolt:  
23 N·m (2.3 kgf·m, 17 lb·ft)

8. Refill with the specified amount of the recommended engine oil.

**TIP** \_\_\_\_\_  
Wipe off any spilled oil before starting the engine.

9. Check the O-ring for damage, and then install the oil filler cap.

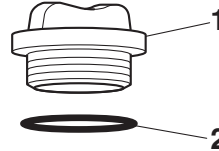

1. Engine oil filler cap
2. O-ring

10. Start the engine and let it idle for several minutes while checking for oil leakage. If any leakage is found, immediately stop the engine and check for the cause.

**TIP** \_\_\_\_\_  
After the engine is started, the oil pressure warning light should go off if the oil level is sufficient.

ECA20860

## **NOTICE** \_\_\_\_\_

**If the oil pressure warning light flickers or remains on even if the oil level is correct, immediately turn the engine off and have a Yamaha dealer**

**check the vehicle.**

11. Turn the engine off, wait a few minutes until the oil settles, and then check the oil level one last time.

# Periodic maintenance and adjustment

EAU85450

## Why Yamalube

YAMALUBE oil is a Genuine YAMAHA Part born of the engineers' passion and belief that engine oil is an important liquid engine component. We form teams of specialists in the fields of mechanical engineering, chemistry, electronics and track testing, and have them develop the engine together with the oil it will use. Yamalube oils take full advantage of the base oil's qualities and blend in the ideal balance of additives to make sure the final oil clears our performance standards. Thus, Yamalube mineral, semisynthetic and synthetic oils have their own distinct characters and value. Yamaha's experience gained over many years of research and development into oil since the 1960's helps make Yamalube the best choice for your Yamaha engine.

# YAMALUBE®

EAU1203

## Coolant

The coolant level should be checked regularly. In addition, the coolant must be changed at the intervals specified in the periodic maintenance chart.

### Recommended coolant:

YAMALUBE coolant

### Coolant quantity:

Coolant reservoir (max level mark):

0.25 L (0.26 US qt, 0.22 Imp.qt)

Radiator (including all routes):

2.25 L (2.38 US qt, 1.98 Imp.qt)

### TIP

If genuine Yamaha coolant is not available, use an ethylene glycol antifreeze containing corrosion inhibitors for aluminum engines and mix with distilled water at a 1:1 ratio.

EAU20097

### To check the coolant level

Since the coolant level varies with engine temperature, check when the engine is cold.

1. Park the vehicle on a level surface.
2. With the vehicle in an upright position, look at the coolant level in the

reservoir.

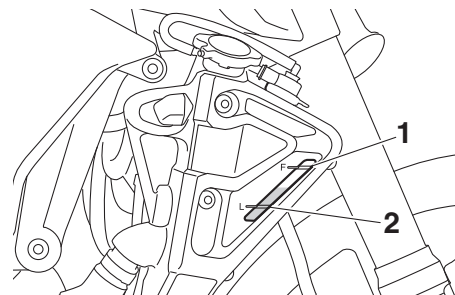

1. Maximum level mark
2. Minimum level mark

3. If the coolant is at or below the minimum level mark, remove the coolant reservoir cap. **WARNING! Remove only the coolant reservoir cap. Never attempt to remove the radiator cap when the engine is hot.**[EWA15162]

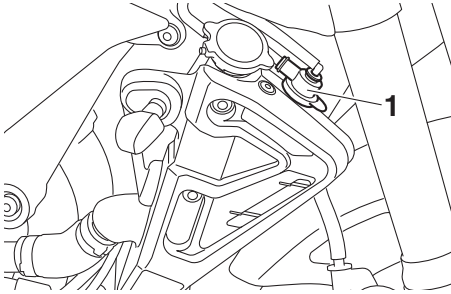

1. Coolant reservoir cap

be reduced.<sup>[ECA10473]</sup>

5. Install the coolant reservoir cap.

EAU33032

## Changing the coolant

The coolant must be changed at the intervals specified in the periodic maintenance and lubrication chart. Have a Yamaha dealer change the coolant.

**WARNING! Never attempt to remove the radiator cap when the engine is hot.**<sup>[EWA10382]</sup>

## Air filter element

The air filter element must be replaced at the intervals specified in the periodic maintenance and lubrication chart. Have a Yamaha dealer replace the air filter element.

4. Add coolant to the maximum level mark. **NOTICE: If coolant is not available, use distilled water or soft tap water instead. Do not use hard water or salt water since it is harmful to the engine. If water has been used instead of coolant, replace it with coolant as soon as possible, otherwise the cooling system will not be protected against frost and corrosion. If water has been added to the coolant, have a Yamaha dealer check the anti-freeze content of the coolant as soon as possible, otherwise the effectiveness of the coolant will**

# Periodic maintenance and adjustment

EAU44735

## Checking the engine idling speed

Check the engine idling speed and, if necessary, have it corrected by a Yamaha dealer.

**Engine idling speed:**  
1200–1400 r/min

EAU21386

## Checking the throttle grip free play

Measure the throttle grip free play as shown.

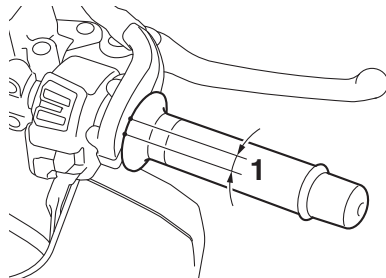

1. Throttle grip free play

**Throttle grip free play:**  
3.0–5.0 mm (0.12–0.20 in)

Periodically check the throttle grip free play and, if necessary, have a Yamaha dealer adjust it.

EAU21403

## Valve clearance

The valves are an important engine component, and since valve clearance changes with use, they must be checked and adjusted at the intervals specified in the periodic maintenance chart. Unadjusted valves can result in improper air-fuel mixture, engine noise, and eventually engine damage. To prevent this from occurring, have your Yamaha dealer check and adjust the valve clearance at regular intervals.

### TIP

This service must be performed when the engine is cold.

# Periodic maintenance and adjustment

EAU64412

## Tires

Tires are the only contact between the vehicle and the road. Safety in all conditions of riding depends on a relatively small area of road contact. Therefore, it is essential to maintain the tires in good condition at all times and replace them at the appropriate time with the specified tires.

## Tire air pressure

The tire air pressure should be checked and, if necessary, adjusted before each ride.

EWA10504

### **WARNING**

**Operation of this vehicle with improper tire pressure may cause severe injury or death from loss of control.**

- The tire air pressure must be checked and adjusted on cold tires (i.e., when the temperature of the tires equals the ambient temperature).
- The tire air pressure must be adjusted in accordance with the riding speed and with the total

**weight of rider, passenger, cargo, and accessories approved for this model.**

### **Cold tire air pressure:**

#### **1 person:**

Front:

250 kPa (2.50 kgf/cm<sup>2</sup>, 36 psi)

Rear:

290 kPa (2.90 kgf/cm<sup>2</sup>, 42 psi)

#### **2 persons:**

Front:

250 kPa (2.50 kgf/cm<sup>2</sup>, 36 psi)

Rear:

290 kPa (2.90 kgf/cm<sup>2</sup>, 42 psi)

### **Maximum load:**

Vehicle:

170 kg (375 lb)

The vehicle's maximum load is the combined weight of the rider, passenger, cargo, and any accessories.

EWA10512

### **WARNING**

**Never overload your vehicle. Operation of an overloaded vehicle could cause an accident.**

## Tire inspection

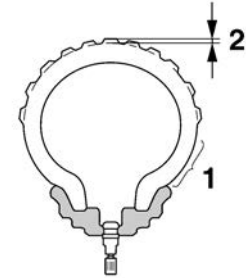

1. Tire sidewall
2. Tire tread depth

The tires must be checked before each ride. If the center tread depth reaches the specified limit, if the tire has a nail or glass fragments in it, or if the sidewall is cracked, have a Yamaha dealer replace the tire immediately.

### **Minimum tire tread depth (front and rear):**

1.6 mm (0.06 in)

## **TIP**

The tire tread depth limits may differ from country to country. Always comply with the local regulations.

# Periodic maintenance and adjustment

EWA10472

## **⚠ WARNING**

- Have a Yamaha dealer replace excessively worn tires. Besides being illegal, operating the vehicle with excessively worn tires decreases riding stability and can lead to loss of control.
- The replacement of all wheel and brake-related parts, including the tires, should be left to a Yamaha dealer, who has the necessary professional knowledge and experience to do so.
- Ride at moderate speeds after changing a tire since the tire surface must first be “broken in” for it to develop its optimal characteristics.

## Tire information

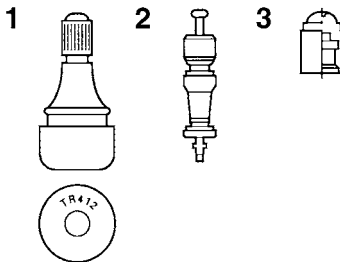

1. Tire air valve
2. Tire air valve core
3. Tire air valve cap with seal

This model is equipped with tubeless tires and tire air valves.

Tires age, even if they have not been used or have only been used occasionally. Cracking of the tread and sidewall rubber, sometimes accompanied by carcass deformation, is an evidence of ageing. Old and aged tires shall be checked by tire specialists to ascertain their suitability for further use.

EWA10902

## **⚠ WARNING**

- The front and rear tires should be of the same make and de-

sign, otherwise the handling characteristics of the motorcycle may be different, which could lead to an accident.

- Always make sure that the valve caps are securely installed to prevent air pressure leakage.
- Use only the tire valves and valve cores listed below to avoid tire deflation during a ride.

After extensive tests, only the tires listed below have been approved for this model by Yamaha.

### **Front tire:**

Size:

120/70ZR17M/C(58W)

Manufacturer/model:

BRIDGESTONE/BATTLAX HY-PERSPORT S20F

### **Rear tire:**

Size:

190/55ZR17M/C(75W)

Manufacturer/model:

BRIDGESTONE/BATTLAX HY-PERSPORT S20R

### **FRONT and REAR:**

Tire air valve:

TR412

Valve core:

#9100 (original)



## WARNING

EWA10601

This motorcycle is fitted with super-high-speed tires. Note the following points in order to make the most efficient use of these tires.

- Use only the specified replacement tires. Other tires may run the danger of bursting at super high speeds.
- Brand-new tires can have a relatively poor grip on certain road surfaces until they have been “broken in”. Therefore, it is advisable before doing any high-speed riding to ride conservatively for approximately 100 km (60 mi) after installing a new tire.
- The tires must be warmed up before a high-speed run.
- Always adjust the tire air pressure according to the operating conditions.

## Cast wheels

To maximize the performance, durability, and safe operation of your vehicle, note the following points regarding the specified wheels.

- The wheel rims should be checked for cracks, bends, warpage or other damage before each ride. If any damage is found, have a Yamaha dealer replace the wheel. Do not attempt even the smallest repair to the wheel. A deformed or cracked wheel must be replaced.
- The wheel should be balanced whenever either the tire or wheel has been changed or replaced. An unbalanced wheel can result in poor performance, adverse handling characteristics, and a shortened tire life.

EAU21963

## Adjusting the clutch lever free play

Measure the clutch lever free play as shown.

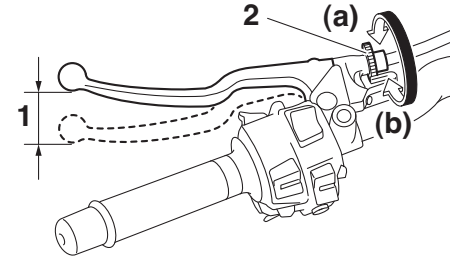

1. Clutch lever free play
2. Clutch lever free play adjusting bolt

**Clutch lever free play:**  
5.0–10.0 mm (0.20–0.39 in)

Periodically check the clutch lever free play and, if necessary, adjust it as follows.

To increase the clutch lever free play, turn the clutch lever free play adjusting bolt at the clutch lever in direction (a). To decrease the clutch lever free play, turn the adjusting bolt in direction (b).

# Periodic maintenance and adjustment

## TIP

If the specified clutch lever free play cannot be obtained as described above, proceed as follows.

1. Fully turn the adjusting bolt at the clutch lever in direction (a) to loosen the clutch cable.
2. Loosen the locknut further down the clutch cable.
3. To increase the clutch lever free play, turn the clutch lever free play adjusting nut in direction (a). To decrease the clutch lever free play, turn the adjusting nut in direction (b).

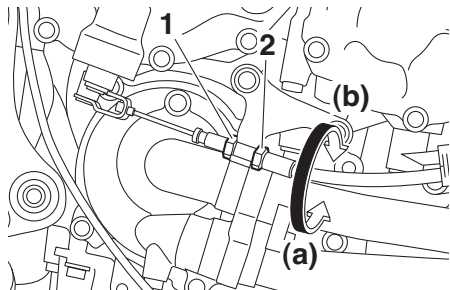

1. Locknut
2. Clutch lever free play adjusting nut
4. Tighten the locknut.

EAU37914

## Checking the brake lever free play

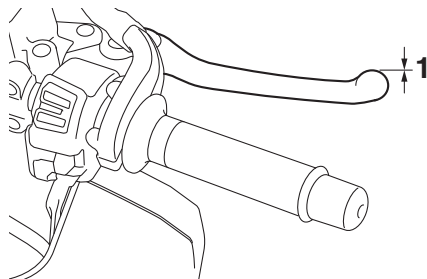

1. No brake lever free play

There should be no free play at the brake lever end. If there is free play, have a Yamaha dealer inspect the brake system.

EWA14212

## **WARNING**

**A soft or spongy feeling in the brake lever can indicate the presence of air in the hydraulic system. If there is air in the hydraulic system, have a Yamaha dealer bleed the system before operating the vehicle. Air in the hydraulic system will diminish the braking performance, which may re-**

**sult in loss of control and an accident.**

# Periodic maintenance and adjustment

## Brake light switches

The brake light should come on just before braking takes effect. The brake light is activated by switches connected to the brake lever and brake pedal. Since the brake light switches are components of the anti-lock brake system, they should only be serviced by a Yamaha dealer.

EAU36505

## Checking the front and rear brake pads

The front and rear brake pads must be checked for wear at the intervals specified in the periodic maintenance and lubrication chart.

EAU22393

### Front brake pads

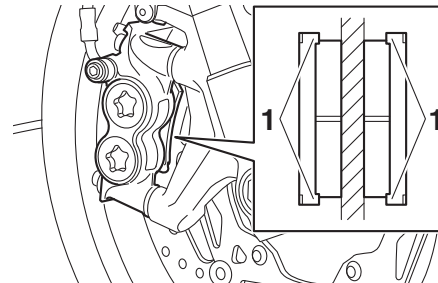

EAU36891

1. Brake pad wear indicator

Each front brake pad is provided with wear indicators, which allows you to check the brake pad wear without having to disassemble the brake. To check the brake pad wear, check the position of the wear indicators while applying the brake. If a brake pad has worn to the point that a wear indicator almost

touches the brake disc, have a Yamaha dealer replace the brake pads as a set.

### Rear brake pads

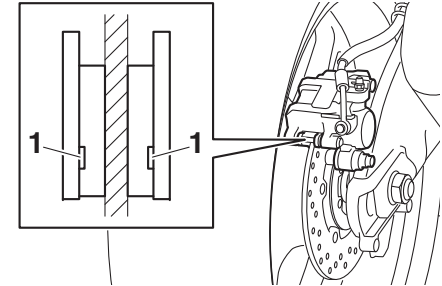

EAU48071

1. Brake pad wear indicator groove

Each rear brake pad is provided with a wear indicator groove, which allows you to check the brake pad wear without having to disassemble the brake. To check the brake pad wear, check the wear indicator groove. If a brake pad has worn to the point that the wear indicator groove almost appears, have a Yamaha dealer replace the brake pads as a set.

# Periodic maintenance and adjustment

EAU22583

## Checking the brake fluid level

Before riding, check that the brake fluid is above the minimum level mark. Check the brake fluid level with the reservoir in an upright position. Replenish the brake fluid if necessary.

**Specified brake fluid:**  
DOT 4

ECA17641

### NOTICE

**Brake fluid may damage painted surfaces or plastic parts. Always clean up spilled fluid immediately.**

7

## Front brake

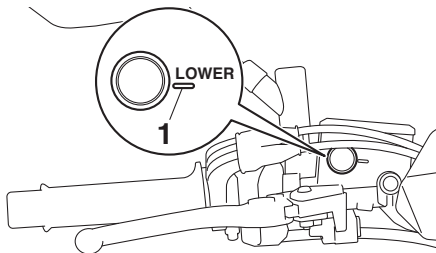

1. Minimum level mark

## Rear brake

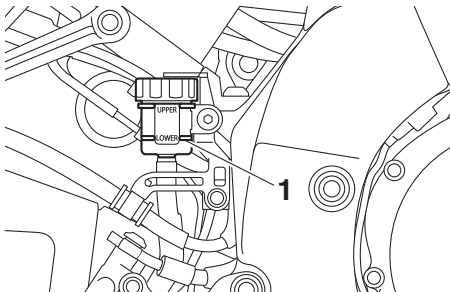

1. Minimum level mark

As the brake pads wear, it is normal for the brake fluid level to gradually go down.

- A low brake fluid level may indicate worn brake pads or brake system leakage; therefore, be sure to check the brake pads for wear and the brake system for leakage.
- If the brake fluid level goes down suddenly, have a Yamaha dealer check the cause before further riding.

EWA15991

### **WARNING**

**Improper maintenance can result in loss of braking ability. Observe these precautions:**

- Insufficient brake fluid may allow air to enter the brake system, reducing braking performance.
- Clean the filler cap before removing. Use only DOT 4 brake fluid from a sealed container.
- Use only the specified brake fluid; otherwise, the rubber seals may deteriorate, causing leakage.
- Refill with the same type of brake fluid. Adding a brake fluid other than DOT 4 may result in a harmful chemical reaction.
- Be careful that water does not enter the brake fluid reservoir when refilling. Water will significantly lower the boiling point of the fluid and may result in vapor lock.

## Changing the brake fluid

EAU22734

Have a Yamaha dealer change the brake fluid every 2 years. In addition, have the seals of the master cylinders and brake calipers, as well as the brake hoses replaced at the intervals listed below or sooner if they are damaged or leaking.

- Brake seals: every 2 years
- Brake hoses: every 4 years

## Drive chain slack

EAU22762

The drive chain slack should be checked before each ride and adjusted if necessary.

### To check the drive chain slack

EAU74252

1. Place the motorcycle on the sidestand.

### TIP

When checking and adjusting the drive chain slack, there should be no weight on the motorcycle.

2. Shift the transmission into the neutral position.
3. Measure the drive chain slack as shown.

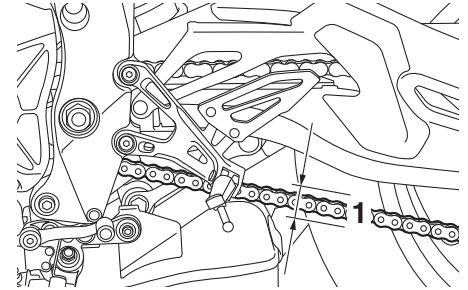

1. Drive chain slack

**Drive chain slack:**  
20.0–30.0 mm (0.79–1.18 in)

4. If the drive chain slack is incorrect, adjust it as follows. **NOTICE: Improper drive chain slack will overload the engine as well as other vital parts of the motorcycle and can lead to chain slippage or breakage. To prevent this from occurring, keep the drive chain slack within the specified limits.**<sup>[ECA10572]</sup>

EAU74260

### To adjust the drive chain slack

Consult a Yamaha dealer before adjusting the drive chain slack.

# Periodic maintenance and adjustment

1. Loosen the axle nut and the locknut on each side of the swingarm.
2. To tighten the drive chain, turn the drive chain slack adjusting bolt on each side of the swingarm in direction (a). To loosen the drive chain, turn the adjusting bolt on each side of the swingarm in direction (b), and then push the rear wheel forward.

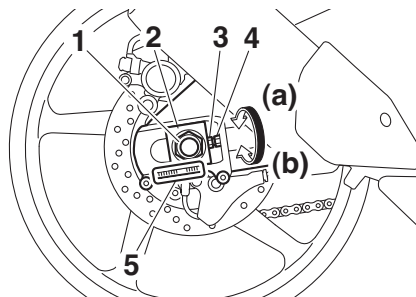

1. Axle nut
2. Drive chain puller
3. Drive chain slack adjusting bolt
4. Locknut
5. Alignment marks

3. Tighten the axle nut, then the locknuts to their specified torques.

## Tightening torques:

Axle nut:

190 N·m (19 kgf·m, 140 lb·ft)

Locknut:

16 N·m (1.6 kgf·m, 12 lb·ft)

4. Make sure that the drive chain pullers are in the same position, the drive chain slack is correct, and the drive chain moves smoothly.

EAU23026

## Cleaning and lubricating the drive chain

The drive chain must be cleaned and lubricated at the intervals specified in the periodic maintenance and lubrication chart, otherwise it will quickly wear out, especially when riding in dusty or wet areas. Service the drive chain as follows.

ECA10584

### NOTICE

**The drive chain must be lubricated after washing the motorcycle, riding in the rain or riding in wet areas.**

1. Clean the drive chain with kerosene and a small soft brush.  
**NOTICE:** To prevent damaging the O-rings, do not clean the drive chain with steam cleaners, high-pressure washers or inappropriate solvents.<sup>[ECA11122]</sup>
2. Wipe the drive chain dry.
3. Thoroughly lubricate the drive chain with a special O-ring chain lubricant. **NOTICE:** Do not use engine oil or any other lubricants for the drive chain, as they

may contain substances that could damage the O-rings.<sup>[ECA11112]</sup>

EAU23098

## Checking and lubricating the cables

The operation of all control cables and the condition of the cables should be checked before each ride, and the cables and cable ends should be lubricated if necessary. If a cable is damaged or does not move smoothly, have a Yamaha dealer check or replace it. **WARNING! Damage to the outer housing of cables may result in internal rusting and cause interference with cable movement. Replace damaged cables as soon as possible to prevent unsafe conditions.**<sup>[EWA10712]</sup>

### Recommended lubricant:

Yamaha cable lubricant or other suitable cable lubricant

EAU23115

## Checking and lubricating the throttle grip and cable

The operation of the throttle grip should be checked before each ride. In addition, the cable should be lubricated by a Yamaha dealer at the intervals specified in the periodic maintenance chart. The throttle cable is equipped with a rubber cover. Make sure that the cover is securely installed. Even though the cover is installed correctly, it does not completely protect the cable from water entry. Therefore, use care not to pour water directly onto the cover or cable when washing the vehicle. If the cable or cover becomes dirty, wipe clean with a moist cloth.

# Periodic maintenance and adjustment

## Checking and lubricating the brake and shift pedals

EAU44276

The operation of the brake and shift pedals should be checked before each ride, and the pedal pivots should be lubricated if necessary.

### Brake pedal

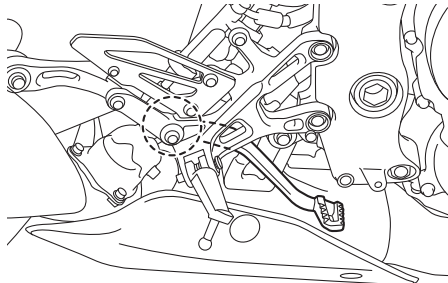

### Shift pedal

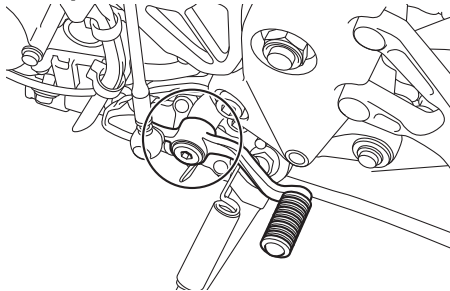

**Recommended lubricant:**  
Lithium-soap-based grease

## Checking and lubricating the brake and clutch levers

EAU23144

The operation of the brake and clutch levers should be checked before each ride, and the lever pivots should be lubricated if necessary.

### Brake lever

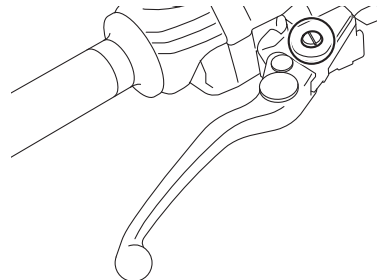



# Periodic maintenance and adjustment

## Clutch lever

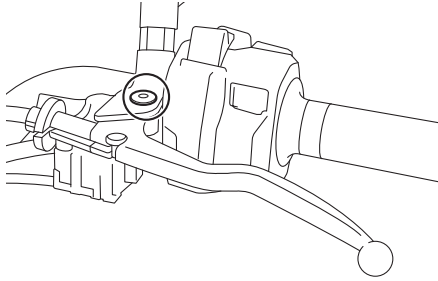

### Recommended lubricants:

- Brake lever:
  - Silicone grease
- Clutch lever:
  - Lithium-soap-based grease

EAU23203

## Checking and lubricating the sidestand

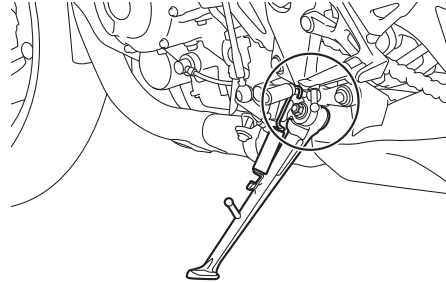

The operation of the sidestand should be checked before each ride, and the sidestand pivot and metal-to-metal contact surfaces should be lubricated if necessary.

EWA10732

### **WARNING**

If the sidestand does not move up and down smoothly, have a Yamaha dealer check or repair it. Otherwise, the sidestand could contact the ground and distract the operator, resulting in a possible loss of control.

**Recommended lubricant:**  
Lithium-soap-based grease

EAUM1653

## Lubricating the swingarm pivots

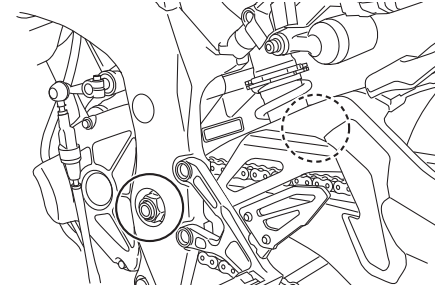

The swingarm pivots must be lubricated by a Yamaha dealer at the intervals specified in the periodic maintenance and lubrication chart.

**Recommended lubricant:**  
Lithium-soap-based grease

# Periodic maintenance and adjustment

EAU23273

## Checking the front fork

The condition and operation of the front fork must be checked as follows at the intervals specified in the periodic maintenance and lubrication chart.

### To check the condition

Check the inner tubes for scratches, damage and excessive oil leakage.

### To check the operation

1. Place the vehicle on a level surface and hold it in an upright position. **WARNING! To avoid injury, securely support the vehicle so there is no danger of it falling over.**<sup>[EWA10752]</sup>
2. While applying the front brake, push down hard on the handlebars several times to check if the front fork compresses and rebounds smoothly.

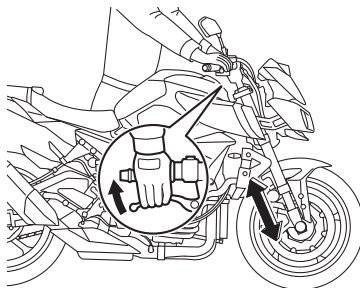

ECA10591

### NOTICE

**If any damage is found or the front fork does not operate smoothly, have a Yamaha dealer check or repair it.**

EAU23285

## Checking the steering

Worn or loose steering bearings may cause danger. Therefore, the operation of the steering must be checked as follows at the intervals specified in the periodic maintenance and lubrication chart.

1. Raise the front wheel off the ground. (See page 7-34.) **WARNING! To avoid injury, securely support the vehicle so there is no danger of it falling over.**<sup>[EWA10752]</sup>
2. Hold the lower ends of the front fork legs and try to move them forward and backward. If any free play can be felt, have a Yamaha dealer check or repair the steering.

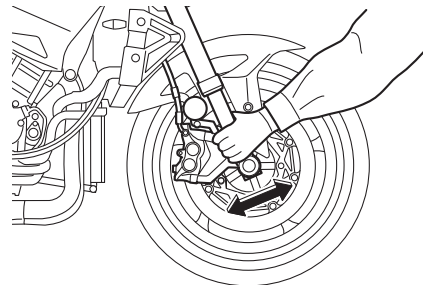

# Periodic maintenance and adjustment

## Checking the wheel bearings

EAU23292

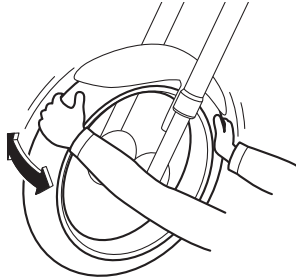

The front and rear wheel bearings must be checked at the intervals specified in the periodic maintenance and lubrication chart. If there is play in the wheel hub or if the wheel does not turn smoothly, have a Yamaha dealer check the wheel bearings.

## Battery

EAU50292

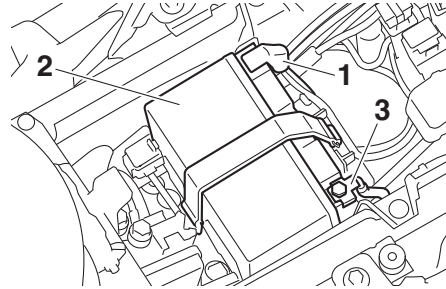

1. Positive battery lead (red)
2. Battery
3. Negative battery lead (black)

The battery is located under the seat. (See page 4-22.)

This model is equipped with a VRLA (Valve Regulated Lead Acid) battery. There is no need to check the electrolyte or to add distilled water. However, the battery lead connections need to be checked and, if necessary, tightened.

EWA10761

### **WARNING**

- **Electrolyte is poisonous and dangerous since it contains sulfuric acid, which causes severe burns. Avoid any contact with**

skin, eyes or clothing and always shield your eyes when working near batteries. In case of contact, administer the following **FIRST AID**.

- **EXTERNAL:** Flush with plenty of water.
- **INTERNAL:** Drink large quantities of water or milk and immediately call a physician.
- **EYES:** Flush with water for 15 minutes and seek prompt medical attention.
- **Batteries produce explosive hydrogen gas. Therefore, keep sparks, flames, cigarettes, etc., away from the battery and provide sufficient ventilation when charging it in an enclosed space.**
- **KEEP THIS AND ALL BATTERIES OUT OF THE REACH OF CHILDREN.**

### To charge the battery

Have a Yamaha dealer charge the battery as soon as possible if it seems to have discharged. Keep in mind that the

# Periodic maintenance and adjustment

battery tends to discharge more quickly if the vehicle is equipped with optional electrical accessories.

ECA16522

## NOTICE

To charge a VRLA (Valve Regulated Lead Acid) battery, a special (constant-voltage) battery charger is required. Using a conventional battery charger will damage the battery.

## To store the battery

1. If the vehicle will not be used for more than one month, remove the battery, fully charge it, and then place it in a cool, dry place. **NOTICE: When removing the battery, be sure to turn the main switch off, then disconnect the negative lead before disconnecting the positive lead.**<sup>[ECA16304]</sup>
2. If the battery will be stored for more than two months, check it at least once a month and fully charge it if necessary.
3. Fully charge the battery before installation. **NOTICE: When installing the battery, be sure to turn**

**the main switch off, then connect the positive lead before connecting the negative lead.**<sup>[ECA16842]</sup>

4. After installation, make sure that the battery leads are properly connected to the battery terminals.

ECA16531

## NOTICE

**Always keep the battery charged. Storing a discharged battery can cause permanent battery damage.**

EAU73994

## Replacing the fuses

The main fuse and ABS motor fuse are located under the seat. (See page 4-22.)

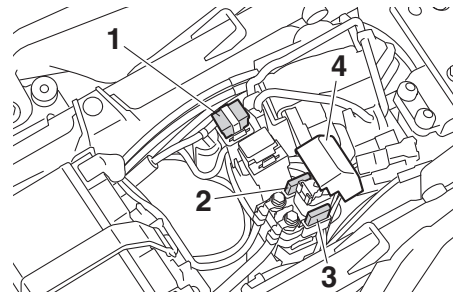

1. Main fuse
2. ABS motor fuse
3. ABS motor spare fuse
4. Starter relay cover

## TIP

Remove the starter relay cover by pulling it upward.

# Periodic maintenance and adjustment

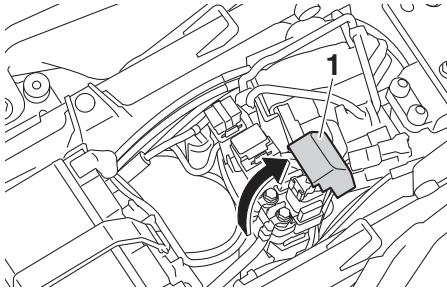

1. Starter relay cover

The fuse boxes, which contain the fuses for the individual circuits, are located behind the left side panels.

To access fuse boxes, remove and install the left side panel A and B as follows.

1. Remove the quick fasteners, and then remove the left side panel A off.

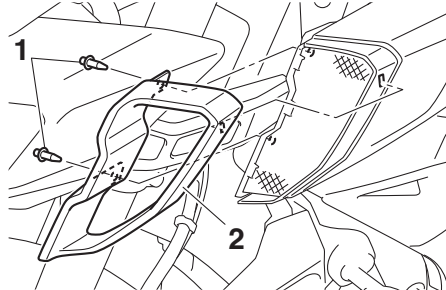

1. Quick fastener
2. Left side panel A

## TIP

The quick fasteners are removed by pushing in the center pin and then pulling the fastener out.

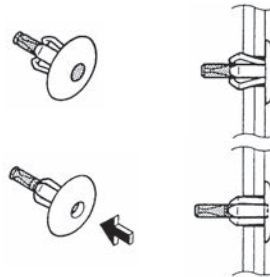

2. Remove the bolts and washers, and then remove the left side pan-

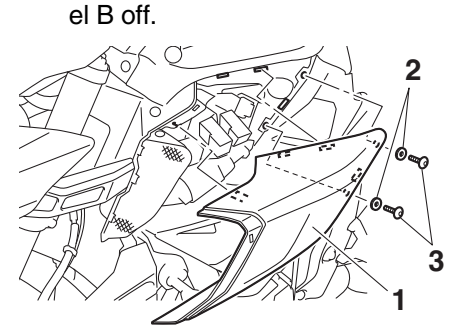

1. Left side panel B
2. Washer
3. Bolt

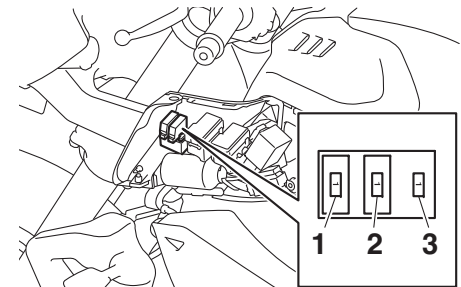

1. Brake light fuse
2. Cruise control fuse
3. Spare fuse

# Periodic maintenance and adjustment

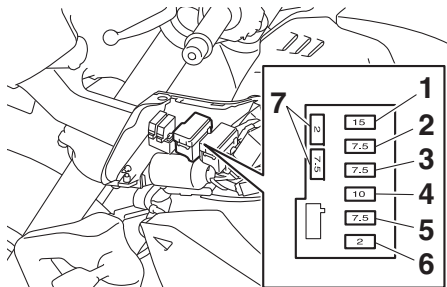

1. Ignition fuse
2. Signaling system fuse
3. ABS ECU fuse
4. Headlight fuse
5. Hazard fuse
6. Terminal fuse 1 (for auxiliary DC jack)
7. Spare fuse

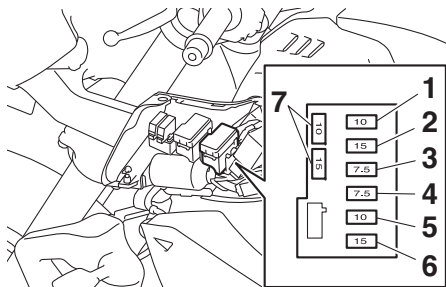

1. ABS solenoid fuse
  2. Fuel injection system fuse
  3. Electronic throttle valve fuse
  4. Backup fuse
  5. Sub radiator fan motor fuse
  6. Radiator fan motor fuse
  7. Spare fuse
3. Place the panels in the original position.
  4. Install the washers, bolts and quick fasteners.

## TIP

The quick fasteners are installed by pushing out the center pin, inserting the fastener into the panel, and then by pushing the center pin flush with the fastener head.

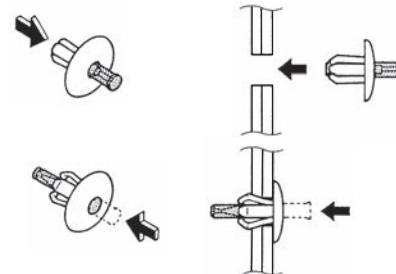

If a fuse is blown, replace it as follows.

1. Turn the key to "OFF" and turn off the electrical circuit in question.
2. Remove the blown fuse, and then install a new fuse of the specified amperage. **WARNING! Do not use a fuse of a higher amperage rating than recommended to avoid causing extensive damage to the electrical system and possibly a fire.**<sup>[EWA15132]</sup>

# Periodic maintenance and adjustment

EAU72980

## Specified fuses:

- Main fuse:  
50.0 A
- Terminal fuse 1:  
2.0 A
- Headlight fuse:  
10.0 A
- Signaling system fuse:  
7.5 A
- Ignition fuse:  
15.0 A
- Radiator fan motor fuse:  
15.0 A
- Sub radiator fan motor fuse:  
10.0 A
- ABS motor fuse:  
30.0 A
- Hazard fuse:  
7.5 A
- ABS ECU fuse:  
7.5 A
- ABS solenoid fuse:  
10.0 A
- Fuel injection system fuse:  
15.0 A
- Backup fuse:  
7.5 A
- Electronic throttle valve fuse:  
7.5 A
- Brake light fuse:  
1.0 A
- Cruise control fuse:  
1.0 A

3. Turn the key to “ON” and turn on the electrical circuit in question to check if the device operates.
4. If the fuse immediately blows again, have a Yamaha dealer check the electrical system.

## Vehicle lights

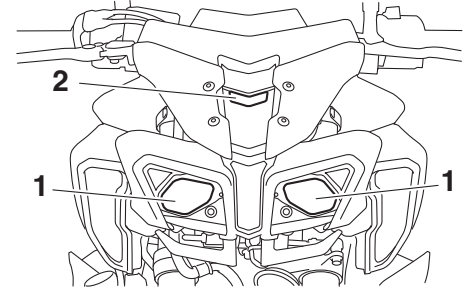

1. Headlight
2. Auxiliary light

This model is equipped with full-LED lighting. There are no user replaceable bulbs.

If a light does not come on, check the fuses and then have a Yamaha dealer check the vehicle.

ECA16581

### **NOTICE**

**Do not affix any type of tinted film or stickers to the headlight lens.**

# Periodic maintenance and adjustment

EAU67131

## Supporting the motorcycle

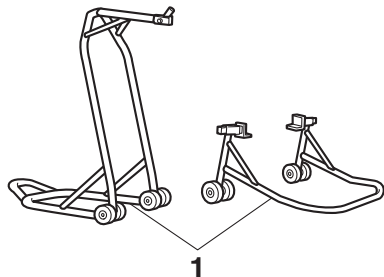

1. Maintenance stand (example)

Since this model is not equipped with a centerstand, use maintenance stands when removing the front or rear wheel or when performing other maintenance that requires the motorcycle to stand up right.

Check that the motorcycle is in a stable and level position before starting any maintenance.

EAU25872

## Troubleshooting

Although Yamaha motorcycles receive a thorough inspection before shipment from the factory, trouble may occur during operation. Any problem in the fuel, compression, or ignition systems, for example, can cause poor starting and loss of power.

The following troubleshooting charts represent quick and easy procedures for checking these vital systems yourself. However, should your motorcycle require any repair, take it to a Yamaha dealer, whose skilled technicians have the necessary tools, experience, and know-how to service the motorcycle properly.

Use only genuine Yamaha replacement parts. Imitation parts may look like Yamaha parts, but they are often inferior, have a shorter service life and can lead to expensive repair bills.

EWA15142

### **WARNING**

**When checking the fuel system, do not smoke, and make sure there are no open flames or sparks in the area, including pilot lights from water**

**heaters or furnaces. Gasoline or gasoline vapors can ignite or explode, causing severe injury or property damage.**



## Troubleshooting charts

### Starting problems or poor engine performance

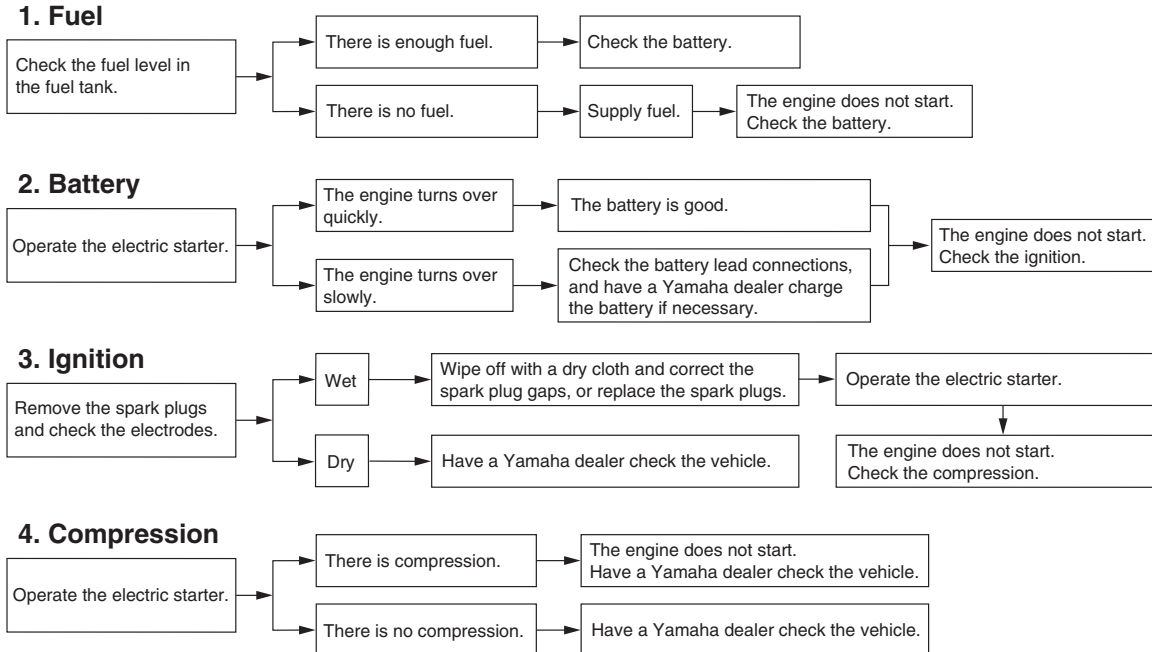

# Periodic maintenance and adjustment

---

## Engine overheating

EWAT1041

### WARNING

- Do not remove the radiator cap when the engine and radiator are hot. Scalding hot fluid and steam may be blown out under pressure, which could cause serious injury. Be sure to wait until the engine has cooled.
  - Place a thick rag, like a towel, over the radiator cap, and then slowly rotate the cap counterclockwise to the detent to allow any residual pressure to escape. When the hissing sound has stopped, press down on the cap while turning it counterclockwise, and then remove the cap.
- 

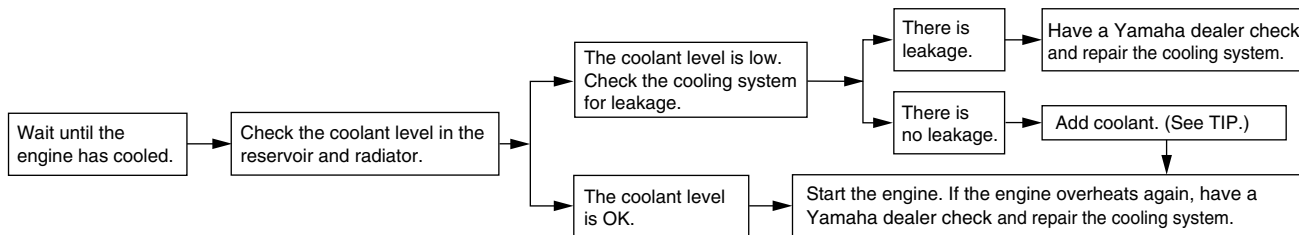

### TIP

If coolant is not available, tap water can be temporarily used instead, provided that it is changed to the recommended coolant as soon as possible.

---

EAU37834

EAU83443

ECA26280

## Matte color caution

### NOTICE

Some models are equipped with matte colored finished parts. Be sure to consult a Yamaha dealer for advice on what products to use before cleaning the vehicle. Using a brush, harsh chemical products or cleaning compounds when cleaning these parts will scratch or damage their surface. Wax also should not be applied to any matte colored finished parts.

ECA15193

## Care

Frequent, thorough cleaning of the vehicle will not only enhance its appearance but also will improve its general performance and extend the useful life of many components. Washing, cleaning, and polishing will also give you a chance to inspect the condition of the vehicle more frequently. Be sure to wash the vehicle after riding in the rain or near the sea, because salt is corrosive to metals.

### TIP

- The roads of heavy snowfall areas may be sprayed with salt as a de-icing method. This salt can stay on the roads well into spring, so be sure to wash the underside and chassis parts after riding in such areas.
- Genuine Yamaha care and maintenance products are sold under the YAMALUBE brand in many markets worldwide.
- See your Yamaha dealer for additional cleaning tips.

### NOTICE

Improper cleaning can cause cosmetic and mechanical damage. Do not use:

- high-pressure washers or steam-jet cleaners. Excessive water pressure may cause water seepage and deterioration of wheel bearings, brakes, transmission seals and electrical devices. Avoid high-pressure detergent applications such as those available in coin-operated car washers.
- harsh chemicals, including strong acidic wheel cleaners, especially on spoke or magnesium wheels.
- harsh chemicals, abrasive cleaning compounds, or wax on matte-finished parts. Brushes can scratch and damage the matte-finish, use soft sponge or towel only.
- towels, sponges, or brushes contaminated with abrasive cleaning products or strong chemicals such as, solvents,

# Motorcycle care and storage

---

**gasoline, rust removers, brake fluid, or antifreeze, etc.**

---

## Before washing

1. Park the vehicle out of direct sunlight and allow it to cool. This will help avoid water spots.
2. Make sure all caps, covers, electrical couplers and connectors are tightly installed.
3. Cover the muffler end with a plastic bag and a strong rubber band.
4. Pre-soak stubborn stains like insects or bird droppings with a wet towel for a few minutes.
5. Remove road grime and oil stains with a quality degreasing agent and a plastic-bristle brush or sponge. **NOTICE: Do not use degreasing agent on areas requiring lubrication such as seals, gaskets, and wheel axles. Follow product instructions.**<sup>[ECA26290]</sup>

## Washing

1. Rinse off any degreaser and spray down the vehicle with a garden hose. Use only enough pressure

to do the job. Avoid spraying water directly into the muffler, instrument panel, air inlet, or other inner areas such as underseat storage compartments.

2. Wash the vehicle with a quality automotive-type detergent mixed with cool water and a soft, clean towel or sponge. Use an old toothbrush or plastic-bristle brush for hard-to-reach places. **NOTICE: Use cold water if the vehicle has been exposed to salt. Warm water will increase salt's corrosive properties.**<sup>[ECA26301]</sup>
3. For windshield-equipped vehicles: Clean the windshield with a soft towel or sponge dampened with water and a pH neutral detergent. If necessary, use a high-quality windshield cleaner or polish for motorcycles. **NOTICE: Never use any strong chemicals to clean the windshield. Additionally, some cleaning compounds for plastic may scratch the windshield, so be sure to test all cleaning products before general application.**<sup>[ECA26310]</sup>

4. Rinse off thoroughly with clean water. Be sure to remove all detergent residues, as they can be harmful to plastic parts.

## After washing

1. Dry the vehicle with a chamois or absorbent towel, preferably micro-fiber terrycloth.
2. For drive chain-equipped models: Dry and then lubricate the drive chain to prevent rust.
3. Use a chrome polish to shine chrome, aluminum, and stainless steel parts. Often the thermally induced discoloring of stainless steel exhaust systems can be removed through polishing.
4. Apply a corrosion protection spray on all metal parts including chrome or nickel-plated surfaces. **WARNING! Do not apply silicone or oil spray to seats, hand grips, rubber foot pegs or tire treads. Otherwise these parts will become slippery, which could cause loss of control. Thoroughly clean the surfaces of these parts before**

## operating the vehicle.<sup>[EWA20650]</sup>

5. Treat rubber, vinyl, and unpainted plastic parts with a suitable care product.
6. Touch up minor paint damage caused by stones, etc.
7. Wax all painted surfaces using a non-abrasive wax or use a detail spray for motorcycles.
8. When finished cleaning, start the engine and let it idle for several minutes to help dry any remaining moisture.
9. If the headlight lens has fogged up, start the engine and turn on the headlight to help remove the moisture.
10. Let the vehicle dry completely before storing or covering it.

ECA26320

## NOTICE

- **Do not apply wax to rubber or unpainted plastic parts.**
- **Do not use abrasive polishing compounds as they will wear away the paint.**
- **Apply sprays and wax sparingly. Wipe off excess afterwards.**

EWA20660

## **WARNING**

**Contaminants left on the brakes or tires can cause loss of control.**

- **Make sure there is no lubricant or wax on the brakes or tires.**
- **If necessary, wash the tires with warm water and a mild detergent.**
- **If necessary, clean the brake discs and pads with brake cleaner or acetone.**
- **Before riding at higher speeds, test the vehicle's braking performance and cornering behavior.**

EAU83450

## **Cleaning the titanium muffler**

This model is equipped with a titanium muffler which requires special care. Use only a soft cloth or sponge and mild detergent with water to clean the muffler. This should remove fingerprints and other oil stains. If necessary, an alkaline pH cleaning product and soft brush may be used. However, do not use abrasive compounds or special treatments to clean the muffler, as these will wear away the protective fin-

ish.

## TIP

The thermally induced discoloring of the exhaust pipe leading into the titanium muffler is normal and cannot be removed.

# Motorcycle care and storage

---

EAU83472

## Storage

Always store the vehicle in a cool, dry place. If necessary, protect it against dust with a porous cover. Be sure the engine and the exhaust system are cool before covering the vehicle. If the vehicle often sits for weeks at a time between uses, the use of a quality fuel stabilizer is recommended after each fill-up.

ECA21170

### NOTICE

- **Storing the vehicle in a poorly ventilated room or covering it with a tarp, while it is still wet, will allow water and humidity to seep in and cause rust.**
- **To prevent corrosion, avoid damp cellars, stables (because of the presence of ammonia) and areas where strong chemicals are stored.**

## Long term storage

Before storing the vehicle long term (60 days or more):

1. Make all necessary repairs and

perform any outstanding maintenance.

2. Follow all instructions in the Care section of this chapter.
3. Fill up the fuel tank, adding fuel stabilizer according to product instructions. Run the engine for 5 minutes to distribute treated fuel through the fuel system.
4. For vehicles equipped with a fuel cock: Turn the fuel cock lever to the off position.
5. For vehicles with a carburetor: To prevent fuel deposits from building up, drain the fuel in the carburetor float chamber into a clean container. Retighten the drain bolt and pour the fuel back into the fuel tank.
6. Use a quality engine fogging oil according to product instructions to protect internal engine components from corrosion. If engine fogging oil is not available, perform the following steps for each cylinder:
  - a. Remove the spark plug cap and spark plug.
  - b. Pour a teaspoonful of engine oil

into the spark plug bore.

- c. Install the spark plug cap onto the spark plug, and then place the spark plug on the cylinder head so that the electrodes are grounded. (This will limit sparking during the next step.)
  - d. Turn the engine over several times with the starter. (This will coat the cylinder wall with oil.) **WARNING! To prevent damage or injury from sparking, make sure to ground the spark plug electrodes while turning the engine over.**<sup>[EWA10952]</sup>
  - e. Remove the spark plug cap from the spark plug, and then install the spark plug and the spark plug cap.
7. Lubricate all control cables, pivots, levers and pedals, as well as the sidestand and centerstand (if equipped).
  8. Check and correct the tire air pressure, and then lift the vehicle so that all wheels are off the ground. Otherwise, turn the wheels a little once a month in order to prevent

the tires from becoming degraded in one spot.

9. Cover the muffler outlet with a plastic bag to prevent moisture from entering it.
10. Remove the battery and fully charge it, or attach a maintenance charger to keep the battery optimally charged. **NOTICE: Confirm that the battery and its charger are compatible. Do not charge a VRLA battery with a conventional charger.**<sup>[ECA26330]</sup>

### TIP

---

- If the battery will be removed, charge it once a month and store it in a temperate location between 0-30 °C (32-90 °F).
  - See page 7-29 for more information on charging and storing the battery.
-

# Specifications

## Dimensions:

- Overall length:  
2095 mm (82.5 in)
- Overall width:  
800 mm (31.5 in)
- Overall height:  
1110 mm (43.7 in)
- Seat height:  
825 mm (32.5 in)
- Wheelbase:  
1400 mm (55.1 in)
- Ground clearance:  
130 mm (5.12 in)
- Minimum turning radius:  
3.3 m (10.83 ft)

## Weight:

- Curb weight:  
210 kg (463 lb)

## Engine:

- Combustion cycle:  
4-stroke
- Cooling system:  
Liquid cooled
- Valve train:  
DOHC
- Cylinder arrangement:  
Inline
- Number of cylinders:  
4-cylinder
- Displacement:  
998 cm<sup>3</sup>
- Bore × stroke:  
79.0 × 50.9 mm (3.11 × 2.00 in)

- Starting system:  
Electric starter

## Engine oil:

- Recommended brand:



- Type:  
Full synthetic
- SAE viscosity grades:  
10W-40
- Recommended engine oil grade:  
API service SG type or higher, JASO standard MA
- Engine oil quantity:  
Oil change:  
3.90 L (4.12 US qt, 3.43 Imp.qt)  
With oil filter removal:  
4.10 L (4.33 US qt, 3.61 Imp.qt)

## Coolant quantity:

- Coolant reservoir (up to the maximum level mark):  
0.25 L (0.26 US qt, 0.22 Imp.qt)
- Radiator (including all routes):  
2.25 L (2.38 US qt, 1.98 Imp.qt)

## Fuel:

- Recommended fuel:  
Premium unleaded gasoline (Gasohol [E10] acceptable)
- Fuel tank capacity:  
17 L (4.5 US gal, 3.7 Imp.gal)
- Fuel reserve amount:  
4.0 L (1.06 US gal, 0.88 Imp.gal)

## Fuel injection:

- Throttle body:  
ID mark:  
B671 00

## Drivetrain:

- Gear ratio:  
1st:  
2.600 (39/15)
- 2nd:  
2.176 (37/17)
- 3rd:  
1.842 (35/19)
- 4th:  
1.579 (30/19)
- 5th:  
1.381 (29/21)
- 6th:  
1.250 (30/24)

## Front tire:

- Type:  
Tubeless
- Size:  
120/70ZR17M/C(58W)
- Manufacturer/model:  
BRIDGESTONE/BATTLAX HYPERS-PORT S20F

## Rear tire:

- Type:  
Tubeless
- Size:  
190/55ZR17M/C(75W)
- Manufacturer/model:  
BRIDGESTONE/BATTLAX HYPERS-PORT S20R



**Loading:**

Maximum load:

170 kg (375 lb)

The vehicle's maximum load is the combined weight of the rider, passenger, cargo and any accessories.

Rear turn signal light:

LED

Auxiliary light:

LED

License plate light:

LED

**Front brake:**

Type:

Hydraulic dual disc brake

**Rear brake:**

Type:

Hydraulic single disc brake

**Front suspension:**

Type:

Telescopic fork

**Rear suspension:**

Type:

Swingarm (link suspension)

**Electrical system:**

System voltage:

12 V

**Battery:**

Model:

YTZ10S

Voltage, capacity:

12 V, 8.6 Ah (10 HR)

**Bulb wattage:**

Headlight:

LED

Brake/tail light:

LED

Front turn signal light:

LED

# Consumer information

EAU53562

## Identification numbers

Record the vehicle identification number, engine serial number, and the model label information in the spaces provided below. These identification numbers are needed when registering the vehicle with the authorities in your area and when ordering spare parts from a Yamaha dealer.

VEHICLE IDENTIFICATION NUMBER:

ENGINE SERIAL NUMBER:

MODEL LABEL INFORMATION:

## Vehicle identification number

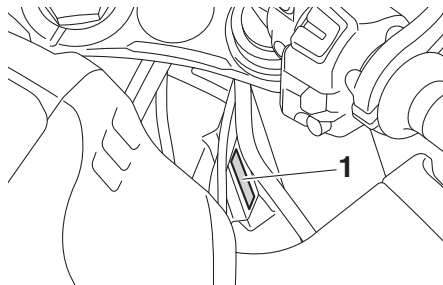

1. Vehicle identification number

The vehicle identification number is stamped into the steering head pipe. Record this number in the space provided.

### TIP \_\_\_\_\_

The vehicle identification number is used to identify your motorcycle and may be used to register your motorcycle with the licensing authority in your area.

---

EAU26401

## Engine serial number

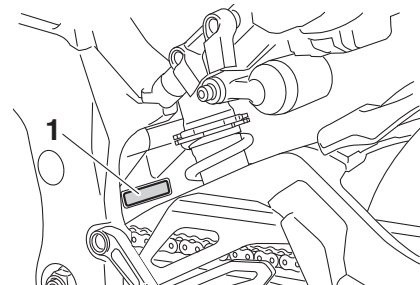

1. Engine serial number

The engine serial number is stamped into the crankcase.

EAU26442

EAU26481

## Model label

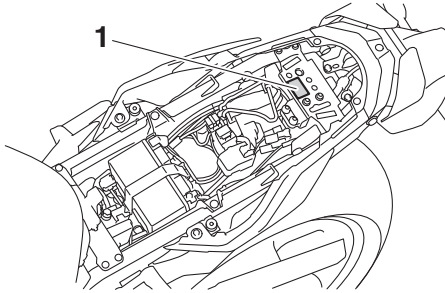

1. Model label

The model label is affixed to the frame under the seat. (See page 4-22.) Record the information on this label in the space provided. This information will be needed when ordering spare parts from a Yamaha dealer.

EAU69910

## Diagnostic connector

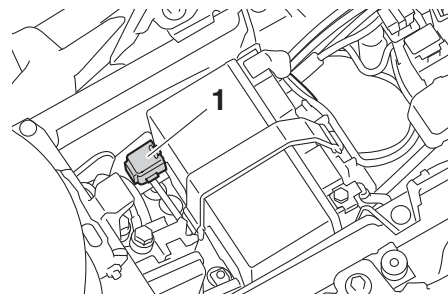

1. Diagnostic connector

The diagnostic connector is located as shown.

EAU85300

## Vehicle data recording

This model's ECU stores certain vehicle data to assist in the diagnosis of malfunctions and for research, statistical analysis and development purposes.

Although the sensors and recorded data will vary by model, the main data points are:

- Vehicle status and engine performance data
- Fuel-injection and emission-related data

This data will be uploaded only when a special Yamaha diagnostic tool is attached to the vehicle, such as when maintenance checks or service procedures are performed.

Vehicle data uploaded will be handled appropriately according to the following Privacy Policy.

## Privacy Policy

<https://www.yamaha-motor.eu/eu/privacy/privacy-policy.aspx>

Yamaha will not disclose this data to a third party except in the following cas-

## Consumer information

---

es. In addition, Yamaha may provide vehicle data to a contractor in order to outsource services related to the handling of vehicle data. Even in this case, Yamaha will require the contractor to properly handle the vehicle data we provided and Yamaha will appropriately manage the data.

- With the consent of the vehicle owner
- Where obligated by law
- For use by Yamaha in litigation
- When the data is not related to an individual vehicle nor owner

- A**
  - ABS ..... 4-17
  - ABS warning light ..... 4-6
  - Air filter element..... 7-15
  - Auxiliary DC jack ..... 4-27
- B**
  - Battery ..... 7-29
  - Brake and clutch levers, checking and lubricating ..... 7-26
  - Brake and shift pedals, checking and lubricating ..... 7-26
  - Brake fluid, changing ..... 7-23
  - Brake fluid level, checking ..... 7-22
  - Brake lever ..... 4-16
  - Brake lever free play, checking ..... 7-20
  - Brake light switches ..... 7-21
  - Brake pedal ..... 4-17
- C**
  - Cables, checking and lubricating ..... 7-25
  - Canister ..... 7-10
  - Care ..... 8-1
  - Catalytic converter ..... 4-21
  - Clutch lever..... 4-16
  - Clutch lever free play, adjusting ..... 7-19
  - Coolant ..... 7-14
  - Coolant temperature warning light..... 4-6
  - Cruise control indicator lights ..... 4-5
  - Cruise control switches..... 4-4
  - Cruise control system ..... 3-1
- D**
  - Data recording, vehicle ..... 10-2
  - Diagnostic connector ..... 10-2
  - Dimmer/Pass switch ..... 4-3
  - D-mode (drive mode)..... 3-3
- Drive chain, cleaning and lubricating .... 7-24
  - Drive chain slack ..... 7-23
  - Drive mode switch ..... 4-4
- E**
  - Engine break-in ..... 6-3
  - Engine idling speed, checking..... 7-16
  - Engine oil ..... 7-10
  - Engine serial number ..... 10-1
  - Engine trouble warning light..... 4-6
  - EXUP system ..... 4-27
- F**
  - Front and rear brake pads, checking .... 7-21
  - Front fork, adjusting ..... 4-22
  - Front fork, checking..... 7-28
  - Fuel ..... 4-19
  - Fuel consumption, tips for reducing ..... 6-3
  - Fuel tank cap..... 4-18
  - Fuel tank overflow hose ..... 4-21
  - Fuses, replacing..... 7-30
- H**
  - Handlebar switches ..... 4-3
  - Hazard switch..... 4-4
  - High beam indicator light..... 4-5
  - Horn switch ..... 4-4
- I**
  - Identification numbers ..... 10-1
  - Ignition circuit cut-off system ..... 4-29
  - Immobilizer system ..... 4-1
  - Immobilizer system indicator light ..... 4-7
  - Indicator lights and warning lights ..... 4-5
- L**
  - Luggage strap holders ..... 4-27
- M**
  - Main switch/steering lock ..... 4-2
- Maintenance and lubrication, periodic .... 7-5
  - Maintenance, emission control system ..... 7-3
  - Matte color, caution ..... 8-1
  - Model label ..... 10-2
  - Multi-function meter unit ..... 4-8
- N**
  - Neutral indicator light ..... 4-5
- O**
  - Oil pressure warning light ..... 4-5
- P**
  - Parking..... 6-4
  - Part locations ..... 2-1
- Q**
  - Quick shift system..... 3-6
- S**
  - Safety information ..... 1-1
  - Seat ..... 4-22
  - SELECT switch ..... 4-4
  - Shift indicator light ..... 4-7
  - Shifting ..... 6-2
  - Shift pedal ..... 4-16
  - Shock absorber assembly, adjusting .... 4-24
  - Sidestand ..... 4-28
  - Sidestand, checking and lubricating .... 7-27
  - Spark plugs, checking..... 7-9
  - Special features ..... 3-1
  - Specifications..... 9-1
  - Starting the engine..... 6-1
  - Steering, checking ..... 7-28
  - Steering damper warning light ..... 4-7
  - Stop/Run/Start switch ..... 4-4
  - Storage ..... 8-4
  - Supporting the motorcycle ..... 7-34

# Index

---

Swingarm pivots, lubricating ..... 7-27

## T

Throttle grip and cable, checking

and lubricating ..... 7-25

Throttle grip free play, checking ..... 7-16

Tires ..... 7-17

Titanium muffler, cleaning ..... 8-3

Tool kit ..... 7-2

Traction control system ..... 3-4

Traction control system indicator light ..... 4-6

Traction control system switch ..... 4-4

Troubleshooting ..... 7-34

Troubleshooting charts ..... 7-35

Turn signal indicator lights ..... 4-5

Turn signal switch ..... 4-4

## V

Valve clearance ..... 7-16

Vehicle identification number ..... 10-1

Vehicle lights ..... 7-33

## W

Wheel bearings, checking ..... 7-29

Wheels ..... 7-19

## Y

Yamalube ..... 7-14



