



⚠ Read this manual carefully before operating this vehicle.

OWNER'S MANUAL

TRACER

MTT850D

B1J-28199-E2

 **Read this manual carefully before operating this vehicle. This manual should stay with this vehicle if it is sold.**

For Europe

Declaration of Conformity:

Hereby, YAMAHA MOTOR ELECTRONICS Co., Ltd declares that the radio equipment type, IMMOBILIZER, 1RC-00 is in compliance with Directive 2014/53/EU.

The full text of the EU declaration of conformity is available at the following internet address:

https://global.yamaha-motor.com/eu_doc/

Frequency band: 134.2 kHz

The maximum radio frequency power: 49.0 [dB μ V/m]

Manufacturer:

YAMAHA MOTOR ELECTRONICS Co., Ltd

1450-6 Mori, Mori-machi, Shuchi-Gun, Shizuoka, 437-0292 Japan

Importer:

YAMAHA MOTOR EUROPE N.V.

Koolhovenlaan 101, 1119 NC Schiphol-Rijk, 1117 ZN, Schiphol, the Netherlands

For South Africa



Welcome to the Yamaha world of motorcycling!

As the owner of the MTT850D, you are benefiting from Yamaha's vast experience and newest technology regarding the design and manufacture of high-quality products, which have earned Yamaha a reputation for dependability.

Please take the time to read this manual thoroughly, so as to enjoy all advantages of your MTT850D. The Owner's Manual does not only instruct you in how to operate, inspect and maintain your motorcycle, but also in how to safeguard yourself and others from trouble and injury.

In addition, the many tips given in this manual will help keep your motorcycle in the best possible condition. If you have any further questions, do not hesitate to contact your Yamaha dealer.

The Yamaha team wishes you many safe and pleasant rides. So, remember to put safety first!

Yamaha continually seeks advancements in product design and quality. Therefore, while this manual contains the most current product information available at the time of printing, there may be minor discrepancies between your motorcycle and this manual. If there is any question concerning this manual, please consult a Yamaha dealer.



 **WARNING**

Please read this manual carefully and completely before operating this motorcycle.

Important manual information

EAU10134

Particularly important information is distinguished in this manual by the following notations:

	This is the safety alert symbol. It is used to alert you to potential personal injury hazards. Obey all safety messages that follow this symbol to avoid possible injury or death.
 WARNING	A WARNING indicates a hazardous situation which, if not avoided, could result in death or serious injury.
NOTICE	A NOTICE indicates special precautions that must be taken to avoid damage to the vehicle or other property.
TIP	A TIP provides key information to make procedures easier or clearer.

*Product and specifications are subject to change without notice.

EAU10201

**MTT850D
OWNER'S MANUAL**
©2020 by Yamaha Motor Co., Ltd.
1st edition, August 2019
All rights reserved.
Any reprinting or unauthorized use
without the written permission of
Yamaha Motor Co., Ltd.
is expressly prohibited.
Printed in Japan.

Table of contents

Safety information	1-1	Storage compartment.....	3-38	General maintenance and lubrication chart	6-5
Description	2-1	Windshield	3-38	Removing and installing the panel.....	6-9
Left view	2-1	Adjusting the headlight beams	3-38	Checking the spark plugs.....	6-10
Right view.....	2-2	Handlebar position	3-39	Canister	6-11
Controls and instruments	2-3	Adjusting the front fork	3-39	Engine oil	6-11
Instrument and control functions ...	3-1	Adjusting the shock absorber assembly.....	3-41	Why Yamalube.....	6-13
Immobilizer system.....	3-1	Auxiliary DC jack.....	3-43	Coolant	6-14
Main switch/steering lock.....	3-2	Auxiliary DC connector	3-44	Air filter element.....	6-15
Handlebar switches.....	3-3	Sidestand	3-44	Checking the engine idling speed	6-15
Indicator lights and warning lights.....	3-5	Ignition circuit cut-off system	3-45	Checking the throttle grip free play.....	6-16
Cruise control system.....	3-8	For your safety – pre-operation checks	4-1	Valve clearance.....	6-16
Display.....	3-11	Operation and important riding points	5-1	Tires	6-16
MENU screen	3-15	Starting the engine.....	5-1	Cast wheels	6-19
D-mode (drive mode).....	3-25	Shifting	5-2	Adjusting the clutch lever free play.....	6-19
Clutch lever	3-25	Tips for reducing fuel consumption	5-4	Checking the brake lever free play.....	6-20
Shift pedal	3-26	Engine break-in	5-4	Brake light switches	6-20
Quick shift system	3-26	Parking	5-5	Checking the front and rear brake pads	6-21
Brake lever.....	3-26	Periodic maintenance and adjustment	6-1	Checking the brake fluid level	6-21
Brake pedal	3-27	Tool kit	6-2	Changing the brake fluid	6-23
ABS	3-27	Periodic maintenance charts	6-3	Drive chain slack.....	6-23
Traction control system.....	3-28	Periodic maintenance chart for the emission control system.....	6-3	Cleaning and lubricating the drive chain.....	6-25
Fuel tank cap.....	3-30	General maintenance and lubrication chart	6-5	Checking and lubricating the cables.....	6-25
Fuel.....	3-31				
Fuel tank overflow hose	3-33				
Catalytic converter	3-33				
Seats	3-34				
Adjusting the rider seat height.....	3-35				
Helmet holder	3-37				

Table of contents

Checking and lubricating the throttle grip and cable.....	6-26	Diagnostic connector.....	9-2
Checking and lubricating the brake and shift pedals	6-26	Vehicle data recording	9-2
Checking and lubricating the brake and clutch levers.....	6-27	Index	10-1
Checking and lubricating the centerstand and sidestand	6-27		
Lubricating the swingarm pivots ...	6-28		
Checking the front fork.....	6-28		
Checking the steering	6-29		
Checking the wheel bearings	6-29		
Battery	6-30		
Replacing the fuses.....	6-31		
Vehicle lights	6-33		
Replacing a turn signal light bulb	6-33		
Replacing the license plate light bulb	6-34		
Troubleshooting	6-35		
Troubleshooting charts	6-36		
Motorcycle care and storage	7-1		
Matte color caution	7-1		
Care.....	7-1		
Storage.....	7-3		
Specifications	8-1		
Consumer information	9-1		
Identification numbers.....	9-1		

Be a Responsible Owner

As the vehicle's owner, you are responsible for the safe and proper operation of your motorcycle.

Motorcycles are single-track vehicles. Their safe use and operation are dependent upon the use of proper riding techniques as well as the expertise of the operator. Every operator should know the following requirements before riding this motorcycle.

He or she should:

- Obtain thorough instructions from a competent source on all aspects of motorcycle operation.
- Observe the warnings and maintenance requirements in this Owner's Manual.
- Obtain qualified training in safe and proper riding techniques.
- Obtain professional technical service as indicated in this Owner's Manual and/or when made necessary by mechanical conditions.

- Never operate a motorcycle without proper training or instruction. Take a training course. Beginners should receive training from a certified instructor. Contact an authorized motorcycle dealer to find out about the training courses nearest you.

Safe Riding

Perform the pre-operation checks each time you use the vehicle to make sure it is in safe operating condition. Failure to inspect or maintain the vehicle properly increases the possibility of an accident or equipment damage. See page 4-1 for a list of pre-operation checks.

- This motorcycle is designed to carry the operator and a passenger.
- The failure of motorists to detect and recognize motorcycles in traffic is the predominating cause of automobile/motorcycle accidents. Many accidents have been caused by an automobile driver who did not see the motorcycle. Making yourself conspicuous ap-

pears to be very effective in reducing the chance of this type of accident.

Therefore:

- Wear a brightly colored jacket.
- Use extra caution when you are approaching and passing through intersections, since intersections are the most likely places for motorcycle accidents to occur.
- Ride where other motorists can see you. Avoid riding in another motorist's blind spot.
- Never maintain a motorcycle without proper knowledge. Contact an authorized motorcycle dealer to inform you on basic motorcycle maintenance. Certain maintenance can only be carried out by certified staff.

- Many accidents involve inexperienced operators. In fact, many operators who have been involved in accidents do not even have a current motorcycle license.
 - Make sure that you are qualified and that you only lend your motorcycle to other qualified operators.
 - Know your skills and limits. Staying within your limits may help you to avoid an accident.
 - We recommend that you practice riding your motorcycle where there is no traffic until you have become thoroughly familiar with the motorcycle and all of its controls.
- Many accidents have been caused by error of the motorcycle operator. A typical error made by the operator is veering wide on a turn due to excessive speed or undercornering (insufficient lean angle for the speed).
 - Always obey the speed limit and never travel faster than warranted by road and traffic conditions.
 - Always signal before turning or changing lanes. Make sure that other motorists can see you.
- The posture of the operator and passenger is important for proper control.
 - The operator should keep both hands on the handlebar and both feet on the operator footrests during operation to maintain control of the motorcycle.
 - The passenger should always hold onto the operator, the seat strap or grab bar, if equipped, with both hands and keep both feet on the passenger footrests. Never carry a passenger unless he or she can firmly place both feet on the passenger footrests.
- Never ride under the influence of alcohol or other drugs.
- This motorcycle is designed for on-road use only. It is not suitable for off-road use.

Protective Apparel

The majority of fatalities from motorcycle accidents are the result of head injuries. The use of a safety helmet is the single most critical factor in the prevention or reduction of head injuries.

- Always wear an approved helmet.
- Wear a face shield or goggles. Wind in your unprotected eyes could contribute to an impairment of vision that could delay seeing a hazard.
- The use of a jacket, heavy boots, trousers, gloves, etc., is effective in preventing or reducing abrasions or lacerations.
- Never wear loose-fitting clothes, otherwise they could catch on the control levers, footrests, or wheels and cause injury or an accident.
- Always wear protective clothing that covers your legs, ankles, and feet. The engine or exhaust system become very hot during or after operation and can cause burns.
- A passenger should also observe the above precautions.

Safety information

1

Avoid Carbon Monoxide Poisoning

All engine exhaust contains carbon monoxide, a deadly gas. Breathing carbon monoxide can cause headaches, dizziness, drowsiness, nausea, confusion, and eventually death.

Carbon Monoxide is a colorless, odorless, tasteless gas which may be present even if you do not see or smell any engine exhaust. Deadly levels of carbon monoxide can collect rapidly and you can quickly be overcome and unable to save yourself. Also, deadly levels of carbon monoxide can linger for hours or days in enclosed or poorly ventilated areas. If you experience any symptoms of carbon monoxide poisoning, leave the area immediately, get fresh air, and SEEK MEDICAL TREATMENT.

- Do not run engine indoors. Even if you try to ventilate engine exhaust with fans or open windows and doors, carbon monoxide can rapidly reach dangerous levels.
- Do not run engine in poorly ventilated or partially enclosed areas such as barns, garages, or carports.

- Do not run engine outdoors where engine exhaust can be drawn into a building through openings such as windows and doors.

Loading

Adding accessories or cargo to your motorcycle can adversely affect stability and handling if the weight distribution of the motorcycle is changed. To avoid the possibility of an accident, use extreme caution when adding cargo or accessories to your motorcycle. Use extra care when riding a motorcycle that has added cargo or accessories. Here, along with the information about accessories below, are some general guidelines to follow if loading cargo to your motorcycle:

The total weight of the operator, passenger, accessories and cargo must not exceed the maximum load limit.

Operation of an overloaded vehicle could cause an accident.

Maximum load:
179 kg (395 lb)

When loading within this weight limit, keep the following in mind:

- Cargo and accessory weight should be kept as low and close to the motorcycle as possible. Securely pack your heaviest items as close to the center of the vehicle as possible and make sure to distribute the weight as evenly as possible on both sides of the motorcycle to minimize imbalance or instability.
- Shifting weights can create a sudden imbalance. Make sure that accessories and cargo are securely attached to the motorcycle before riding. Check accessory mounts and cargo restraints frequently.
- Properly adjust the suspension for your load (suspension-adjustable models only), and check the condition and pressure of your tires.
- Never attach any large or heavy items to the handlebar, front fork, or front fender. These items, including such cargo as sleeping bags, duffel bags, or

tents, can create unstable handling or a slow steering response.

- **This vehicle is not designed to pull a trailer or to be attached to a sidecar.**

Genuine Yamaha Accessories

Choosing accessories for your vehicle is an important decision. Genuine Yamaha accessories, which are available only from a Yamaha dealer, have been designed, tested, and approved by Yamaha for use on your vehicle.

Many companies with no connection to Yamaha manufacture parts and accessories or offer other modifications for Yamaha vehicles. Yamaha is not in a position to test the products that these aftermarket companies produce. Therefore, Yamaha can neither endorse nor recommend the use of accessories not sold by Yamaha or modifications not specifically recommended by Yamaha, even if sold and installed by a Yamaha dealer.

Aftermarket Parts, Accessories, and Modifications

While you may find aftermarket products similar in design and quality to genuine Yamaha accessories, recognize that some aftermarket accessories or modifications are not suitable because of potential safety hazards to you or others. Installing aftermarket products or having other modifications performed to your vehicle that change any of the vehicle's design or operation characteristics can put you and others at greater risk of serious injury or death. You are responsible for injuries related to changes in the vehicle.

Keep the following guidelines in mind, as well as those provided under "Loading" when mounting accessories.

- Never install accessories or carry cargo that would impair the performance of your motorcycle. Carefully inspect the accessory before using it to make sure that it does not in any way reduce ground clearance or cornering clearance, limit suspension travel,

steering travel or control operation, or obscure lights or reflectors.

- Accessories fitted to the handlebar or the front fork area can create instability due to improper weight distribution or aerodynamic changes. If accessories are added to the handlebar or front fork area, they must be as lightweight as possible and should be kept to a minimum.
- Bulky or large accessories may seriously affect the stability of the motorcycle due to aerodynamic effects. Wind may attempt to lift the motorcycle, or the motorcycle may become unstable in cross winds. These accessories may also cause instability when passing or being passed by large vehicles.
- Certain accessories can displace the operator from his or her normal riding position. This improper position limits the freedom of movement of the

Safety information

1

operator and may limit control ability, therefore, such accessories are not recommended.

- Use caution when adding electrical accessories. If electrical accessories exceed the capacity of the motorcycle's electrical system, an electric failure could result, which could cause a dangerous loss of lights or engine power.

Aftermarket Tires and Rims

The tires and rims that came with your motorcycle were designed to match the performance capabilities and to provide the best combination of handling, braking, and comfort. Other tires, rims, sizes, and combinations may not be appropriate. See page 6-16 for tire specifications and for information on servicing and replacing your tires.

Transporting the Motorcycle

Be sure to observe following instructions before transporting the motorcycle in another vehicle.

- Remove all loose items from the motorcycle.
- Check that the fuel cock (if equipped) is in the off position and that there are no fuel leaks.
- Shift the transmission into gear (for models with a manual transmission).
- Secure the motorcycle with tie-downs or suitable straps that are attached to solid parts of the motorcycle, such as the frame or upper front fork triple clamp (and not, for example, to rubber-mounted handlebars or turn signals, or parts that could break). Choose the location for the straps carefully so the straps will not rub against painted surfaces during transport.
- The suspension should be compressed somewhat by the tie-downs, if possible, so that the motorcycle will not bounce excessively during transport.

Left view

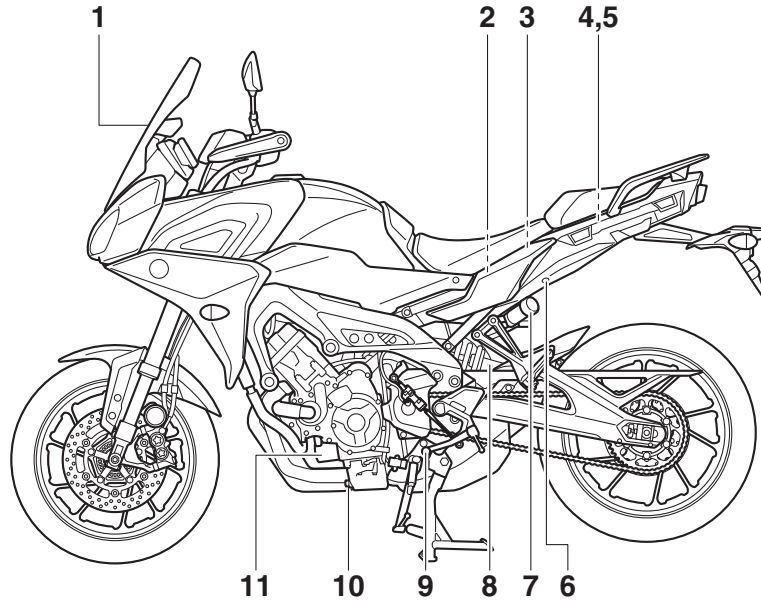

1. Windshield (page 3-38)

2. Battery (page 6-30)

3. Fuses (page 6-31)

4. Storage compartment (page 3-38)

5. Tool kit (page 6-2)

6. Seat lock (page 3-34)

7. Spring preload adjuster (page 3-41)

8. Rebound damping force adjuster (page 3-41)

9. Shift pedal (page 3-26)

10. Engine oil drain bolt (page 6-11)

11. Engine oil filter cartridge (page 6-11)

Description

EAU10421

Right view

2

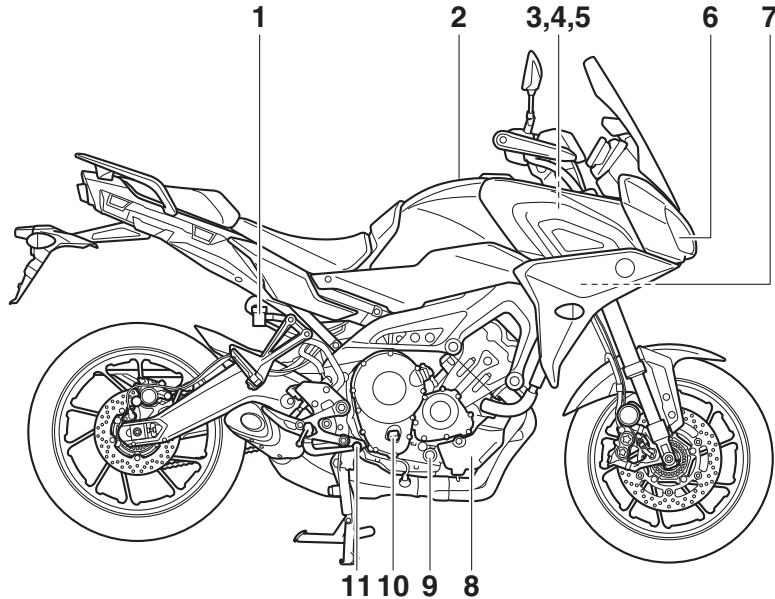

1. Rear brake fluid reservoir (page 6-21)
2. Fuel tank cap (page 3-30)
3. Rebound damping force adjuster (page 3-39)
4. Spring preload adjuster (page 3-39)
5. Compression damping force adjuster (page 3-39)
6. Headlight (page 6-33)
7. Fuses (page 6-31)
8. Coolant reservoir (page 6-14)

9. Engine oil level check window (page 6-11)
10. Engine oil filler cap (page 6-11)
11. Brake pedal (page 3-27)

Controls and instruments

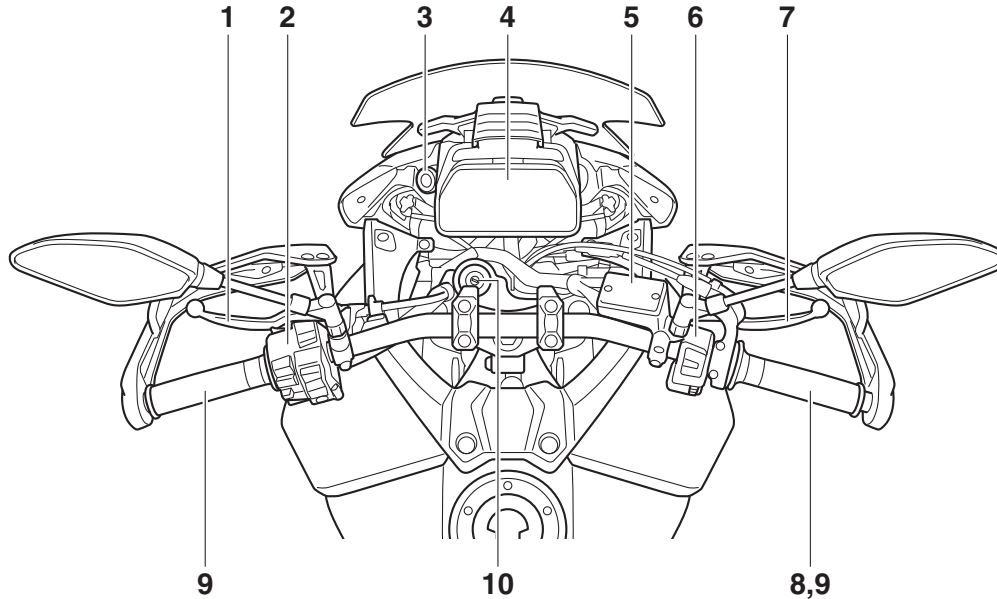

- 1. Clutch lever (page 3-25)
- 2. Left handlebar switches (page 3-3)
- 3. Auxiliary DC jack (page 3-43)
- 4. Instrument panel (page 3-5, 3-11)
- 5. Front brake fluid reservoir (page 6-21)
- 6. Right handlebar switches (page 3-3)
- 7. Brake lever (page 3-26)
- 8. Throttle grip (page 6-16)

- 9. Grip warmer (page 3-14)
- 10. Main switch/steering lock (page 3-2)

Instrument and control functions

3

Immobilizer system

EAU10979

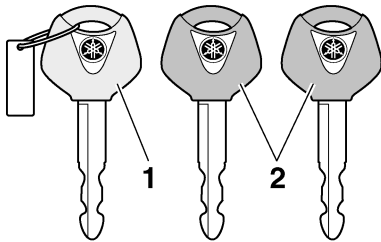

1. Code re-registering key (red bow)
2. Standard keys (black bow)

This vehicle is equipped with an immobilizer system to help prevent theft by re-registering codes in the standard keys. This system consists of the following:

- a code re-registering key
- two standard keys
- a transponder (in each key)
- an immobilizer unit (on the vehicle)
- an ECU (on the vehicle)
- a system indicator light (page 3-7)

About the keys

The key with the red bow is used to register codes in each standard key. Store the code re-registering key in a safe place. When necessary, take the vehicle along with all three keys to a Yamaha dealer to have them re-registered.

Do not use the key with the red bow for driving. It should only be used for re-registering the standard keys. Always use a standard key for driving.

TIP

- Keep the standard keys as well as keys of other immobilizer systems away from the code re-registering key.
- Keep other immobilizer system keys away from the main switch as they may cause signal interference.

ECA11823

NOTICE

DO NOT LOSE THE CODE RE-REGISTERING KEY! CONTACT YOUR DEALER IMMEDIATELY IF IT IS LOST! If the code re-registering key is lost, the existing standard keys

can still be used to start the vehicle. However, registering a new standard key is impossible. If all keys have been lost or damaged, the entire immobilizer system must be replaced. Therefore, handle the keys carefully.

- Do not submerge in water.
- Do not expose to high temperatures.
- Do not place near magnets.
- Do not place near items that transmit electrical signals.
- Do not handle roughly.
- Do not grind or alter.
- Do not disassemble.
- Do not put two keys of any immobilizer system on the same key ring.

Main switch/steering lock

EAU10474

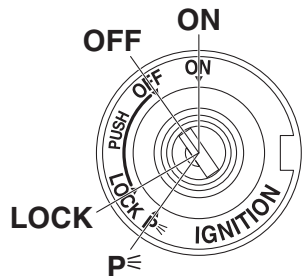

The main switch/steering lock controls the ignition and lighting systems, and is used to lock the steering. The various positions are described below.

TIP

Be sure to use the standard key (black bow) for regular use of the vehicle. To minimize the risk of losing the code re-registering key (red bow), keep it in a safe place and only use it for code re-registering.

ON

All electrical circuits are supplied with power and the vehicle lights are turned on. The engine can be started. The key cannot be removed.

TIP

- The headlight(s) will turn on when the engine is started.
- To prevent battery drain, do not leave the key in the on position without the engine running.

OFF

All electrical systems are off. The key can be removed.

⚠ WARNING

Never turn the key to "OFF" or "LOCK" while the vehicle is moving. Otherwise the electrical systems will be switched off, which may result in loss of control or an accident.

EAU84031

LOCK

The steering is locked and all electrical systems are off. The key can be removed.

To lock the steering

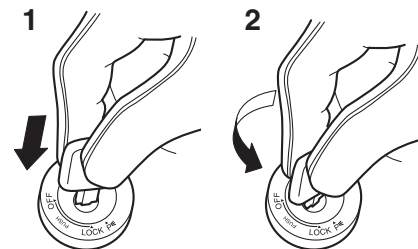

1. Push.
2. Turn.

1. Turn the handlebars all the way to the left.
2. With the key in the "OFF" position, push the key in and turn it to "LOCK".
3. Remove the key.

Instrument and control functions

ECA20760

EAU66055

TIP _____
If the steering will not lock, try turning the handlebars back to the right slightly.

NOTICE _____
Using the hazard or turn signal lights for an extended length of time may cause the battery to discharge.

3 To unlock the steering

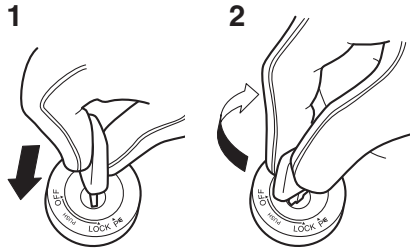

1. Push.
2. Turn.

From the “LOCK” position, push the key in and turn it to “OFF”.

EAU59680

p (Parking)

The hazard lights and turn signal lights can be turned on, but all other electrical systems are off. The key can be removed.

The steering must be locked before the key can be turned to “p”.

Handlebar switches

Left

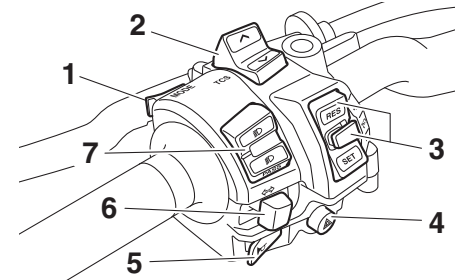

1. Drive mode switch “MODE”
2. TCS switch “^/▼”
3. Cruise control switches
4. Hazard switch “△”
5. Horn switch “📢”
6. Turn signal switch “←/→”
7. Dimmer/Pass switch “≡/≡/PASS”

Right

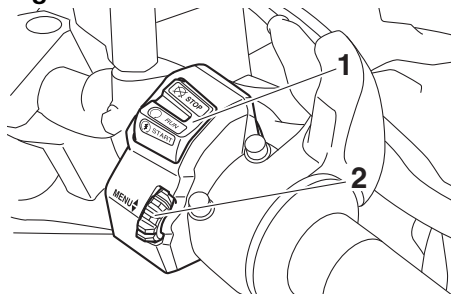

1. Stop/Run/Start switch “/○/⊗”
2. Wheel switch “MENU ”

Dimmer/Pass switch “/⊗/PASS”

EAU73924

Set this switch to “” for the high beam and to “⊗” for the low beam. To flash the high beam, press the switch down to “PASS” while the headlights are on low beam.

TIP

When the switch is set to low beam, only the left headlight comes on. When the switch is set to high beam, both headlights come on.

Turn signal switch “/⊗”

EAU66040

To signal a right-hand turn, push this switch to “”. To signal a left-hand turn, push this switch to “”. When released, the switch returns to the center position. To cancel the turn signal lights, push the switch in after it has returned to the center position.

Horn switch “”

EAU66030

Press this switch to sound the horn.

TCS switch “/⊗”

EAU84240

See page 3-28 for an explanation of the traction control system.

Stop/Run/Start switch “/○/⊗”

EAU66060

To crank the engine with the starter, set this switch to “○”, and then push the switch down towards “⊗”. See page 5-1 for starting instructions prior to starting the engine. Set this switch to “” to stop the engine in case of an emergency, such as when the vehicle overturns or when the throttle cable is stuck.

Hazard switch “”

EAU66010

With the key in the “ON” or “P<” position, use this switch to turn on the hazard lights (simultaneous flashing of all turn signal lights).

The hazard lights are used in case of an emergency or to warn other drivers when your vehicle is stopped where it might be a traffic hazard.

NOTICE

Do not use the hazard lights for an extended length of time with the engine not running, otherwise the battery may discharge.

Cruise control switches

EAU84250

See page 3-8 for an explanation of the cruise control system.

Drive mode switch “MODE”

EAU84260

See page 3-25 for an explanation of the drive mode.

Instrument and control functions

3

Wheel switch “MENU”

EAU84271

When the display is set to the main screen, use the wheel switch to scroll and reset the information display items and to set the grip warmers.

When the display has been changed to the MENU screen, use the wheel switch to navigate the setting modules and make setting changes.

Operate the wheel switch as follows.

Rotate up - rotate the wheel upward to scroll up or increase a setting value.

Rotate down - rotate the wheel downward to scroll down or decrease a setting value.

Short push - briefly press the switch inward to make and confirm selections.

Long push - press the switch inward for one second to reset an information display item or to access and exit the MENU screen.

TIP

- The MENU screen can be accessed by long pushing the wheel switch except when the grip

warmer display is selected or the fuel tripmeter (F-TRIP) is displayed.

- See page 3-11 for more information on the main screen and its functions.
- See page 3-15 for more information on the MENU screen and how to make setting changes.

Indicator lights and warning lights

EAU4939G

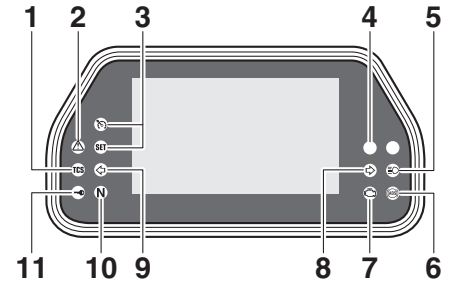

1. Traction control system indicator light “TCS”
2. Engine oil and Coolant warning light “△”
3. Cruise control indicator lights “TCS” “SET”
4. Shift indicator light
5. High beam indicator light “≡”
6. ABS warning light “(S)”
7. Engine trouble warning light “⊕”
8. Right turn signal indicator light “↗”
9. Left turn signal indicator light “↖”
10. Neutral indicator light “N”
11. Immobilizer system indicator light “→”

Turn signal indicator lights “↖” and “↗”

EAU11032

Each indicator light will flash when its corresponding turn signal lights are flashing.

Neutral indicator light “N”

EAU11061

This indicator light comes on when the transmission is in the neutral position.

High beam indicator light “ ”

EAU11081

This indicator light comes on when the high beam of the headlight is switched on.

Cruise control indicator lights “ ” and “SET”

EAU58402

These indicator lights come on when the cruise control system is activated. (See page 3-8.)

TIP

When the vehicle is turned on, these lights should come on for a few seconds and then go off. If the lights do not come on, have a Yamaha dealer check the vehicle.

Engine trouble warning light “ ”

EAU79310

This warning light comes on if a problem is detected in the engine. If this occurs, have a Yamaha dealer check the on-board diagnostic system.

The electrical circuit of the warning light can be checked by turning the vehicle power on. The warning light should come on for a few seconds, and then go off.

If the warning light does not come on at all, or if the warning light remains on, have a Yamaha dealer check the vehicle.

ABS warning light “ ”

EAU58532

In normal operation, the ABS warning light comes on when the vehicle is turned on and goes off after traveling at a speed of 10 km/h (6 mi/h) or higher.

If the ABS warning light:

- does not come on when the vehicle is turned on
 - does not go off after traveling 10 km/h (6 mi/h)
 - comes on or flashes while riding
- then the ABS (3-27) may not work correctly. If any of the above occurs, have a Yamaha dealer check the vehicle as soon as possible.

WARNING

EWA16041

If the ABS warning light does not go off after traveling at a speed of 10 km/h (6 mi/h) or higher, or if the warning light comes on or flashes while riding, the brake system reverts to conventional braking. If either of the above occurs, or if the warning light does not come on at all, use extra caution to avoid possible wheel lock during emergency braking. Have a Yamaha dealer check the brake system and electrical circuits as soon as possible.

Traction control system indicator light “TCS”

EAU78591

This indicator light will flash when traction control has engaged. If the traction control system is turned off, this indicator light will come on. (See page 3-28.)

Instrument and control functions

3

TIP _____
When the vehicle is turned on, the light should come on for a few seconds and then go off. If the light does not come on, or if the light remains on, have a Yamaha dealer check vehicle.

EAU67432

Shift indicator light

This indicator light comes on when it is time to shift to the next higher gear. The engine speeds at which it comes on or goes off can be adjusted. (See page 3-18.)

As a self-check, the light will come on briefly when the vehicle is first powered on.

EAU73120

Immobilizer system indicator light “”

When the key is turned to “OFF” and 30 seconds have passed, the indicator light will flash steadily to indicate the immobilizer system is enabled. After 24 hours have passed, the indicator light will stop flashing, however the immobilizer system is still enabled.

The electrical circuit of the indicator light can be checked by turning the key to “ON”. The indicator light should come on for a few seconds, and then go off.

If the indicator light does not come on initially when the key is turned to “ON”, if the indicator light remains on, or if the indicator light flashes in a pattern (if a problem is detected in the immobilizer system, the immobilizer system indicator light will flash in a pattern), have a Yamaha dealer check the vehicle.

TIP _____
If the immobilizer system indicator light flashes in the pattern, slowly 5 times then quickly 2 times, this could be caused by transponder interference. If this occurs, try the following.

1. Make sure there are no other immobilizer keys close to the main switch. Other immobilizer system keys may cause signal interference and prevent the engine from starting.
2. Use the code re-registering key to start the engine.

3. If the engine starts, turn it off, and try starting the engine with the standard keys.
4. If one or both of the standard keys do not start the engine, take the vehicle and all 3 keys to a Yamaha dealer to have the standard keys re-registered.

EAU84281

Engine oil and Coolant warning light “”

This warning light comes on if the engine oil level is low or if the coolant temperature is high. If this occurs, stop the engine immediately.

When the vehicle is turned on, the warning light should come on for a few seconds, and then go off. If the warning light does not come on, have a Yamaha dealer check the vehicle.

ECA26391

NOTICE _____

If the engine oil and coolant warning light comes on while the engine is running, stop the vehicle and engine immediately.

- If the engine is overheating, the coolant temperature warning icon will come on. Let the engine cool. Check the coolant level (see page 6-37).
- If the engine oil level is low, the engine oil warning icon will come on. Check the oil level (see page 6-11).
- If the warning light remains on after letting the engine cool and confirming the proper oil level, have a Yamaha dealer check the vehicle. Do not continue to operate the vehicle!

Cruise control system



EAU84291

This model is equipped with a cruise control system designed to maintain a set cruising speed.

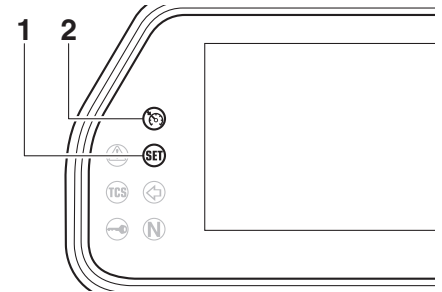

The cruise control system operates only when riding in 4th, 5th or 6th gear at speeds between about 50 km/h (31 mi/h) and 160 km/h (100 mi/h).

EWA16341

⚠ WARNING

- **Improper use of the cruise control system may result in loss of control, which could lead to an accident. Do not activate the cruise control system in heavy traffic, poor weather conditions, or among winding, slippery, hilly, rough or gravel roads.**
- **When traveling uphill or downhill, the cruise control system may not be able to maintain the set cruising speed.**
- **To prevent accidentally activating the cruise control system, turn it off when not in use. Make sure that the cruise control system indicator light “

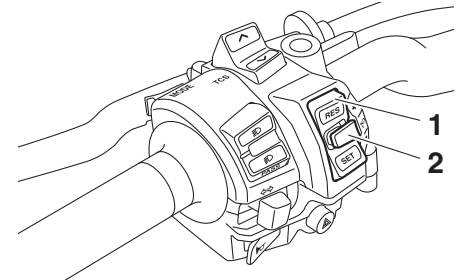
A line drawing of the instrument cluster. Two lines, labeled '1' and '2', point to specific indicator lights. Line 1 points to a light with the word 'SET' inside a circle. Line 2 points to a light with a car icon and a speedometer needle icon.**

1. Cruise control setting indicator light “SET”
2. Cruise control system indicator light “

A line drawing of the handlebar controls. Two lines, labeled '1' and '2', point to specific switches. Line 1 points to a switch with 'RES+' and 'SET-' markings. Line 2 points to a switch with a car icon and a speedometer needle icon.

1. Cruise control setting switch “RES+/SET-”
2. Cruise control power switch “

3

Instrument and control functions

Activating and setting the cruise control system

1. Push the cruise control power switch “

3

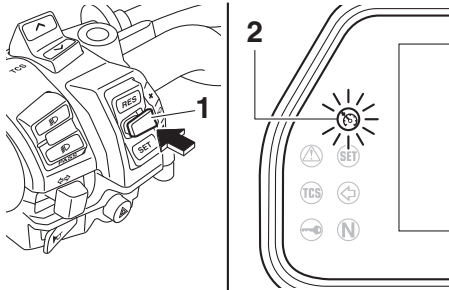

1. Cruise control power switch “
 2. Push the “SET-” side of the cruise control setting switch to activate the cruise control system. Your current traveling speed will become the set cruising speed. The cruise control setting indicator light “SET” will come on.

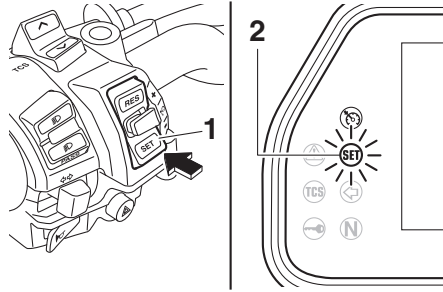

1. Cruise control setting switch “RES+ / SET-”
2. Cruise control setting indicator light “SET”

Adjusting the set cruising speed

While the cruise control system is operating, push the “RES+” side of the cruise control setting switch to increase the set cruising speed or the “SET-” side to decrease the set speed.

TIP

Pushing the setting switch once will change the speed in increments of approximately 2.0 km/h (1.2 mi/h). Holding the “RES+” or “SET-” side of the cruise control setting switch down will increase or decrease the speed continuously until the switch is released.

You can also manually increase your traveling speed using the throttle. After you have accelerated, you can set a new cruising speed by pushing the “SET-” side of the setting switch. If you do not set a new cruising speed, when you return the throttle grip, the vehicle will decelerate to the previously set cruising speed.

Deactivating the cruise control system

Perform one of the following operations to cancel the set cruising speed. The “SET” indicator light will go off.

- Turn the throttle grip past the closed position in the deceleration direction.

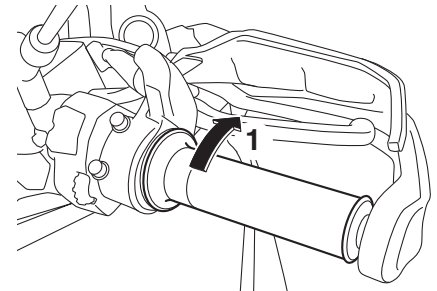

1. Deceleration direction

- Apply the front or rear brake.
- Squeeze the clutch lever.
- Use the shift pedal.

Push the power switch to turn off the cruise control system. The “” indicator light and the “SET” indicator light will go off.

TIP

Traveling speed decreases as soon as the cruise control system is deactivated; unless the throttle grip is turned.

Using the resume function

Push the “RES+” side of the cruise control setting switch to reactivate the cruise control system. The traveling speed will return to the previously set cruising speed. The “SET” indicator light will come on.

EWA16351



It is dangerous to use the resume function when the previously set cruising speed is too high for current conditions.

TIP



Pushing the power switch while the system is operating will turn the system off completely and erase the previously set cruising speed. You will not be able to use the resume function until a new cruising speed has been set.

Automatic deactivation of the cruise control system

The cruise control system for this model is electronically controlled and is linked with the other control systems. The cruise control system will automatically become deactivated under the following conditions:

- The cruise control system is not able to maintain the set cruising speed.
- Wheel slip or wheel spin is detected. (If the traction control system has not been turned off, the traction control system will work.)
- The start/engine stop switch is set to the “” position.
- The engine stalls.
- The sidestand is lowered.

When traveling with a set cruising speed, if the cruise control system is deactivated under the above conditions, the “” indicator light will go off and the “SET” indicator light will flash for 4 seconds, and then go off.

When not traveling with a set cruising speed, if the start/engine stop switch is set to the “” position, the engine stalls, or the sidestand is lowered, then the “” indicator light will go off (the “SET” indicator light will not flash).

If the cruise control system is automatically deactivated, please stop and confirm that your vehicle is in good operating condition.

Before using the cruise control system again, activate it using the power switch.

TIP

In some cases, the cruise control system may not be able to maintain the set cruising speed when the vehicle is traveling uphill or downhill.

- When the vehicle is traveling uphill, the actual traveling speed may become lower than the set cruis-

Instrument and control functions

3

ing speed. If this occurs, accelerate to the desired traveling speed using the throttle.

- When the vehicle is traveling downhill, the actual traveling speed may become higher than the set cruising speed. If this occurs, the setting switch cannot be used to adjust the set cruising speed. To reduce the traveling speed, apply the brakes. When the brakes are applied, the cruise control system will become deactivated.

Display

EAU84301

The following items can be found on the display.

- Speedometer
- Tachometer
- Fuel meter
- Information display
- Transmission gear display
- Drive mode display
- TCS display
- Air temperature display
- Grip warmer display
- QS indicator
- Clock
- Revolution peak hold indicator
- Eco indicator
- Fuel level warning icon
- Engine oil warning icon
- Coolant temperature warning icon

TIP

This model uses a thin-film-transistor liquid-crystal display (TFT LCD) for good contrast and readability in various lighting conditions. However, due to the nature of this technology, it is normal for a small number of pixels to be inactive.

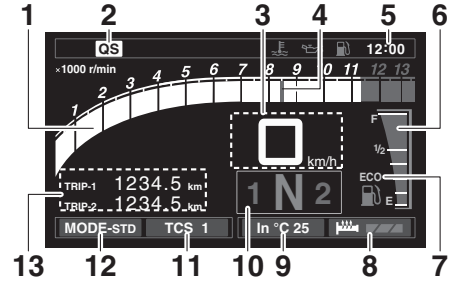

1. Tachometer
2. QS indicator
3. Speedometer
4. Revolution peak hold indicator
5. Clock
6. Fuel meter
7. Eco indicator “ECO”
8. Grip warmer display
9. Air temperature display
10. Transmission gear display
11. TCS display
12. Drive mode display
13. Information display

WARNING

EWA18210

Stop the vehicle before making any setting changes. Changing settings while riding can distract the operator and increase the risk of an accident.

Speedometer

The speedometer shows the vehicle's traveling speed.

TIP

The display can be set to miles or kilometers. Use the "Unit" module on the MENU screen.

Tachometer

The tachometer shows the engine speed, as measured by the rotational velocity of the crankshaft, in revolutions per minute (r/min). When the vehicle is first powered on, the tachometer will sweep across the r/min range and then return to zero.

TIP

The tachometer can be color-adjusted and has a revolution peak hold indicator which can be turned on or off.

NOTICE

ECA10032

Do not operate the engine in the tachometer red zone.

Red zone: 11250 r/min and above

Fuel meter

The fuel meter indicates the amount of fuel in the fuel tank. The display segments of the fuel meter disappear from "F" (full) towards "E" (empty) as the fuel level decreases.

When the last segment starts flashing and the fuel level warning icon comes on, refuel as soon as possible.

TIP

If all the fuel meter display segments flash repeatedly, have a Yamaha dealer check the related circuits.

Clock

The clock uses a 12-hour time system.

Information display

This section of the main screen is used to show additional riding related information such as air and coolant temperature readings, tripmeters, and fuel consumption statistics. The information display items can be set into four groups via the MENU screen.

The information display items are:

A.TEMP: air temperature

C.TEMP: coolant temperature

TRIP-1: tripmeter 1

TRIP-2: tripmeter 2

F-TRIP: fuel tripmeter

ODO: odometer

FUEL CON: the amount of fuel consumed

FUEL AVG: average fuel consumption

CRNT FUEL: current fuel consumption

TIP

- ODO will lock at 999999.
- TRIP-1 and TRIP-2 will reset and continue counting after 9999.9 has been reached.

Instrument and control functions

3

- When the fuel tank reserve level has been reached, F-TRIP appears automatically and begins recording distance traveled from that point.
- After refueling and traveling some distance, F-TRIP will automatically disappear.
- See “Unit” on page 3-16 to change the fuel consumption units, set the clock, and switch between miles and kilometers, etc.

TRIP-1, TRIP-2, F-TRIP, FUEL CON, and FUEL AVG items can be individually reset.

To reset information display items

1. Use the wheel switch to scroll through the display items until the item you want to reset appears.
2. Short push the wheel switch and the item will flash for five seconds. If both items are resettable items, the top item will flash first. Scroll down to select the bottom item.
3. While the item is flashing, press and hold the wheel switch for one second.

Transmission gear display

This shows which gear the transmission is in. This model has 6 gears and a neutral position. The neutral position is indicated by the neutral indicator light “N” and by the transmission gear display “N”.

Revolution peak hold indicator

This small bar momentarily appears within the tachometer to mark the most recent peak r/min speed of the engine.

TIP _____

The indicator comes on momentarily only if the peak engine speed is 7000 r/min or higher.

QS indicator

When the key is turned to “ON”, the quick shift system (page 3-26) turns on and this indicator comes on.

TIP _____

If a problem is detected in the quick shift system, this indicator will turn off and the quick shift system will be unavailable. Have a Yamaha dealer check the vehicle.

Eco indicator

This indicator comes on when the vehicle is being operated in an environmentally friendly, fuel-efficient manner. The indicator goes off when the vehicle is stopped.

TIP _____

Consider the following tips to reduce fuel consumption:

- Avoid high engine speeds during acceleration.
- Travel at a constant speed.
- Select the transmission gear that is appropriate for the vehicle speed.

Drive mode display

This display indicates which drive mode has been selected: “STD”, “A” or “B”. (See page 3-25.)

TCS display

This display indicates which traction control system setting has been selected: “1”, “2” or “OFF”. (See page 3-28.)

Air temperature display





This display indicates the air temperature from $-9\text{ }^{\circ}\text{C}$ to $50\text{ }^{\circ}\text{C}$ in $1\text{ }^{\circ}\text{C}$ increments.

TIP

- $-9\text{ }^{\circ}\text{C}$ will be displayed even if the air temperature falls below $-9\text{ }^{\circ}\text{C}$.
- $50\text{ }^{\circ}\text{C}$ will be displayed even if the ambient temperature climbs above $50\text{ }^{\circ}\text{C}$.
- The temperature displayed may vary from the actual ambient temperature.

Grip warmer display

The grip warmers can be used when the engine is running. There are 4 grip warmer settings.

Display	Setting
 OFF	Off
 Low	Low
 Middle	Middle
 High	High

To change the grip warmer setting

1. Select the grip warmer display.

2. Short push the wheel switch, and then rotate the wheel switch up or down to change the setting while the display is flashing. Short push the wheel switch to confirm the setting.

TIP



Each grip warmer setting can be fine tuned in “Grip Warmer Setting” (see page 3-23).

NOTICE

- Be sure to wear gloves when using the grip warmers.
- Do not use the grip warmers in warm weather.
- If the handlebar grip or throttle grip becomes worn or damaged, stop using the grip warmers and replace the grips.

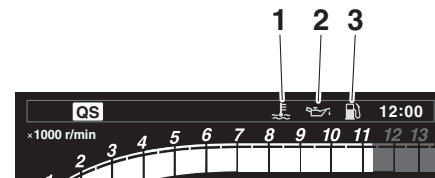
Warning icons



1. Coolant temperature warning “”
2. Engine oil warning “”
3. Fuel level warning “”

Coolant temperature warning “”

This icon comes on if the coolant temperature reaches $117\text{ }^{\circ}\text{C}$ or higher. Stop the vehicle and turn off the engine. Allow the engine to cool.

NOTICE

Do not continue to operate the engine if it is overheating.

Engine oil warning “”

This icon comes on when the engine oil level is low. Stop the vehicle and correct the engine oil level.

Instrument and control functions

When the vehicle is turned on, this icon will come on for a few seconds, and then go off.

If a malfunction is detected, the oil level warning icon will flash repeatedly. Have a Yamaha dealer check the vehicle.

3

NOTICE

ECA26400

Do not continue to operate the engine if the oil level is low.

Fuel level warning “”

This icon comes on when approximately 2.6 L (0.69 US gal, 0.57 Imp.gal) of fuel remains in the tank.

If a malfunction is detected, the fuel level warning icon will flash repeatedly. Have a Yamaha dealer check the vehicle.

MENU screen

EAU84311

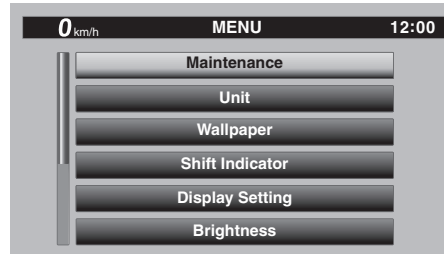

The MENU screen contains the following setting modules. Select a module to make related setting changes. Although some settings can be changed or reset via the main screen, the MENU screen offers access to all display and control settings.

Module	Description
Maintenance	View and reset three maintenance item intervals.
Unit	Set fuel consumption units.
Wallpaper	Set background color.
Shift Indicator	Turn the shift indicator on/off and adjust tachometer settings.
Display Setting	Set the multi-function display window items.
Brightness	Adjust screen brightness.

Grip Warmer Setting	Set the low, middle, and high settings to 10 temperature levels.
Clock	Adjust the clock.
All Reset	Return all settings to factory default settings.

MENU access and operation

The following wheel switch operations are common operations for accessing, selecting, and moving within the MENU screen and its modules.

Long push - press and hold the wheel switch for one second to access the MENU screen or exit MENU entirely.

Select - rotate the wheel switch up or down to highlight the desired module or setting item and then short push the wheel switch (briefly press the wheel switch inward) to confirm the selection.

Triangle mark - certain setting screens have an upward pointing triangle mark item. Select the triangle mark to exit that screen and move back one screen (or long push the wheel switch to exit MENU entirely).

TIP

- The MENU screen can be accessed by long pushing the wheel switch, except when the grip warmer display is selected or the fuel tripmeter (F-TRIP) is displayed.
- Should vehicle motion be detected, the screen will automatically exit MENU and change to the main screen.

“Maintenance”

This module allows you to record distance traveled between engine oil changes (use the OIL item), and for two other items of your choice (use INTERVAL 1 and INTERVAL 2).

To reset a maintenance item

1. From the MENU screen, select “Maintenance”.

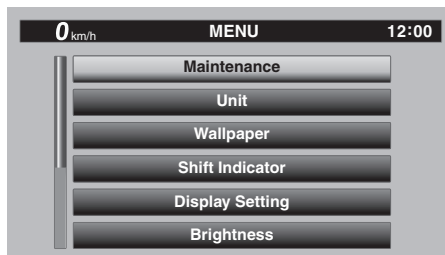

2. Select the item you want to reset.

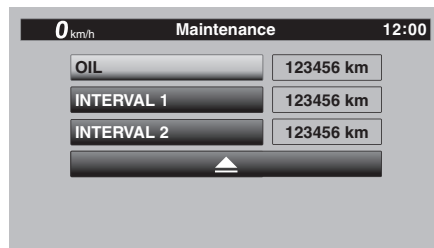

3. Long push the wheel switch to reset the item.

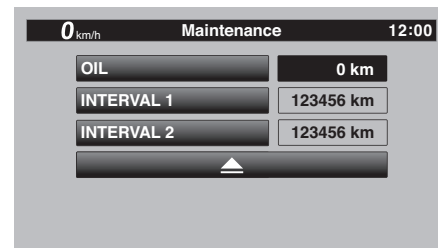

TIP

Maintenance item names cannot be changed.

“Unit”

This module allows you to switch the display between kilometers and miles. When using kilometers, the fuel consumption units can be changed between km/L or L/100km. When using miles, MPG will be available.

To set the distance or fuel consumption units

1. From the MENU screen, select “Unit”.

Instrument and control functions

3



2. Select the distance or consumption unit item you want to adjust.

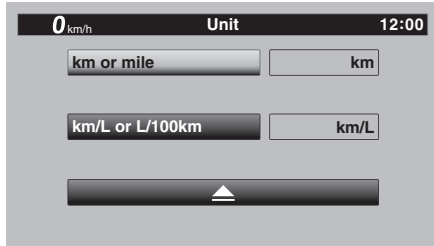

TIP

When “km” is selected, “km/L” or “L/100km” can be set as the fuel consumption units. To set the fuel consumption units, proceed as follows. If “mile” is selected, skip step 3.

3. Select the units you want to use.

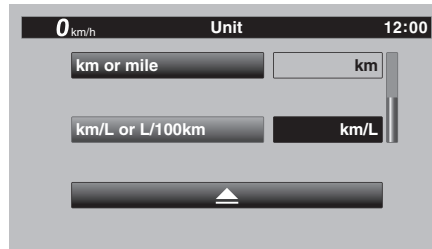

4. Select the triangle symbol to exit.

“Wallpaper”

This module allows you to set the main screen background color to black or white for both the day and night settings. A photo sensor equipped in the instrument panel detects lighting conditions and will automatically change the display between its day and night settings. The photo sensor also controls a subtle automatic brightness adjustment function within both the day and night modes to suit ambient light conditions.



1. Photo sensor

To set the wallpaper

1. From the MENU screen, select “Wallpaper”.

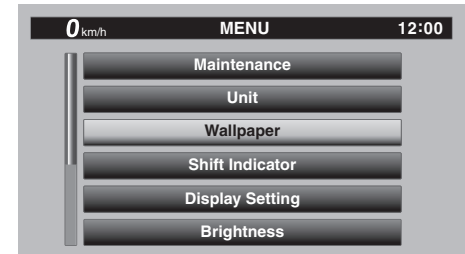

2. Select the mode you want to adjust (select DAY for daytime display settings or NIGHT for nighttime display settings).

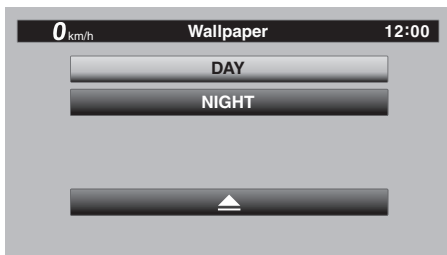

3. Select the background color (select **BLACK** for a black background or **WHITE** for a white background).

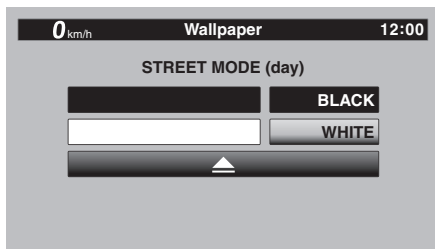

4. Select the triangle symbol to exit.
5. To set another background color, repeat from step 2 or select the triangle symbol to exit this module.

“Shift indicator”

The shift indicator module contains the following items.

Display	Description
Shift IND Setting	Set the shift indicator pattern to “ON”, “Flash”, or “OFF” and adjust at what r/min the indicator will come on and go off.
Shift IND Brightness	Adjust the brightness of the shift indicator.
Tach IND Setting	Set the tachometer color display to “ON” or “OFF” and adjust at what r/min the tachometer will be green and orange.
Peak Rev IND Setting	Set the tachometer revolution peak hold indicator to “ON” or “OFF”.

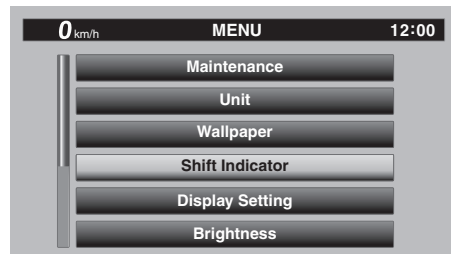

To make setting changes

1. Select “Shift IND Setting”.

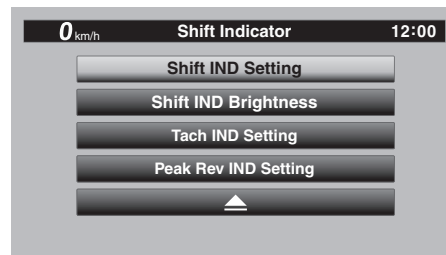

2. Select “IND Mode”.

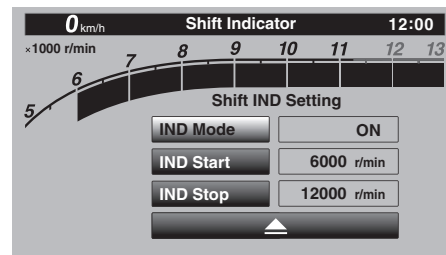

3. Select “ON” to have the indicator light steadily, “OFF” to turn the indicator off, or “Flash” to have the shift indicator flash when the indicator start threshold has been reached.

Instrument and control functions

3

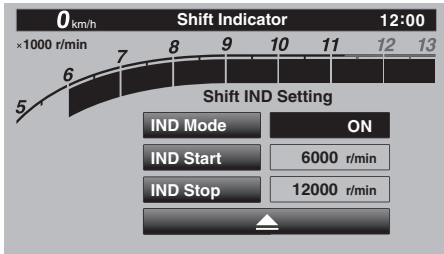

4. Select “IND Start”.

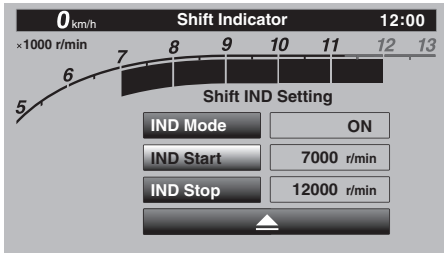

5. Rotate the wheel switch to adjust the r/min at which the shift indicator light will come on. “IND Start” operational range is 5000–12800 r/min.

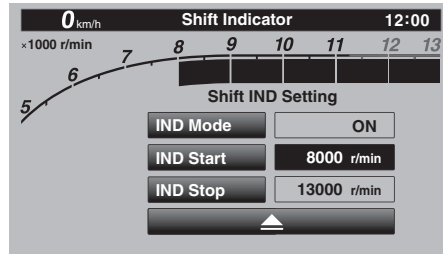

6. Select “IND Stop” then rotate the wheel switch to adjust the r/min at which the shift indicator will go off. “IND Stop” operational range is 5500–13000 r/min.

TIP

The blue area on the tachometer indicates the currently set operational range of the shift indicator light.

“Shift IND Brightness”

The shift indicator light has six brightness levels.

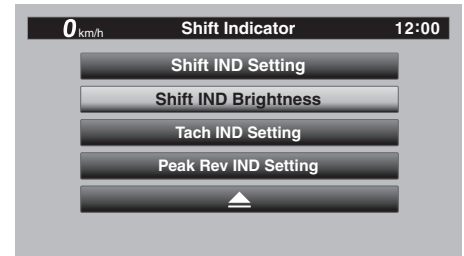

Select “Shift IND Brightness”, then use the wheel switch to adjust the setting. Short push the wheel switch to confirm the setting and exit.

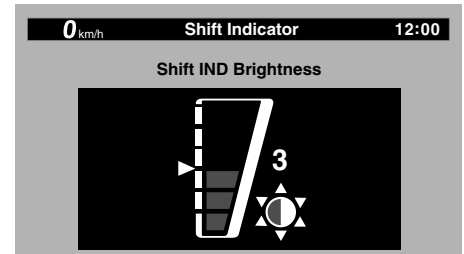

“Tach IND Setting”

This module allows you to turn the tachometer color display on or off. When turned off, the tachometer will display all r/min levels below the red zone in

Instrument and control functions

black or white (depending on wallpaper settings). When turned on, the mid and mid-to-high r/min zones can be set to come on in green and then orange colors.

1. Select “Tach IND Setting”.

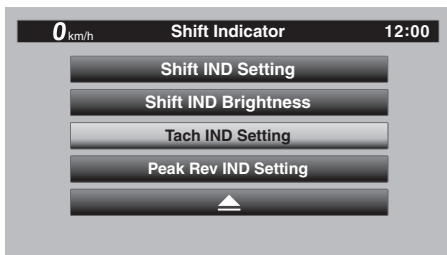

2. Select “IND Mode”.

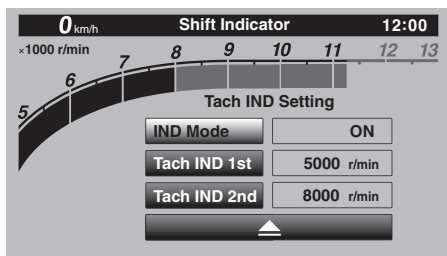

3. Select ON to turn the tachometer color display mode on (or select OFF to turn this function off).

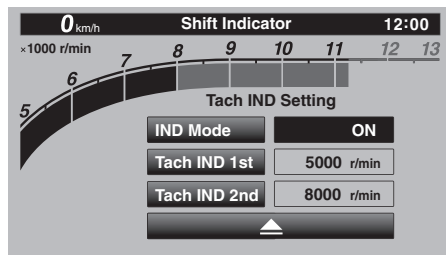

4. Select “Tach IND 1st” to set the green zone starting r/min.

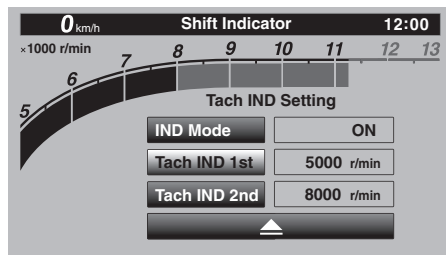

5. Set the starting r/min by rotating and then short pushing the wheel switch. All r/min above this value

up to the “Tach IND 2nd” setting value (or the red zone), will be displayed in green.

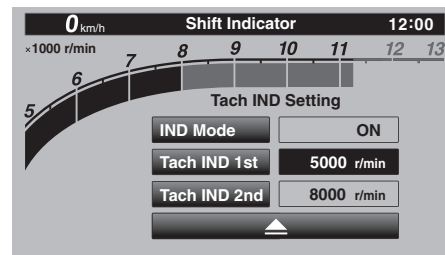

TIP

Green bar start setting range: 5000–11300 r/min.

6. Select “Tach IND 2nd”.

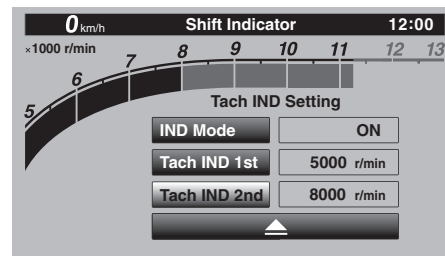

Instrument and control functions

- Set the orange color starting r/min by rotating and then short pushing the wheel switch. All r/min above this figure until the red zone, will be displayed in orange.

3

TIP

Orange bar start setting range: 5000–11300 r/min.

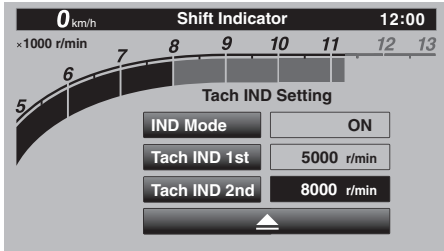

- Select the triangle symbol to exit.

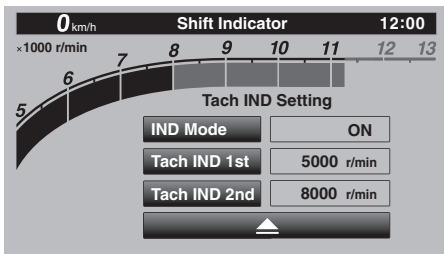

“Peak Rev IND Setting”

This module allows you to turn the revolution peak hold indicator on or off.

- Select “Peak Rev IND Setting”.

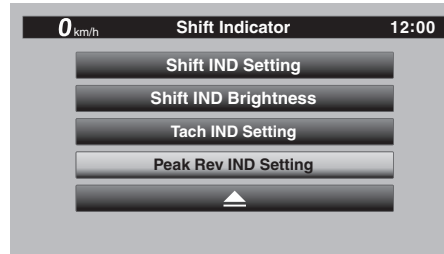

- Select “IND Mode” and then select ON (to turn on the indicator) or OFF (to turn off the indicator).

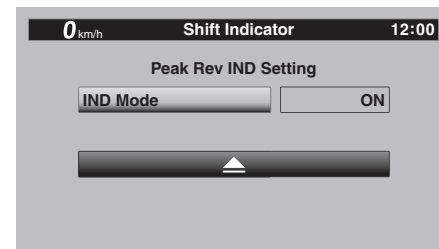

- Select the triangle symbol to exit.

“Display Setting”

This module allows you to set how the information display items (like TRIP-1, ODO, C. TEMP, etc.) are grouped on the main screen. There are four display groups.

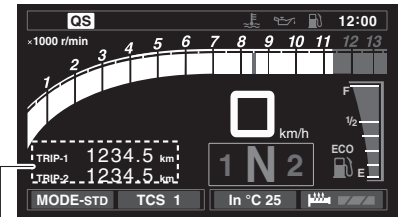

1

- Information display

To set the display groups

- From the MENU screen, select “Display Setting”.

Instrument and control functions

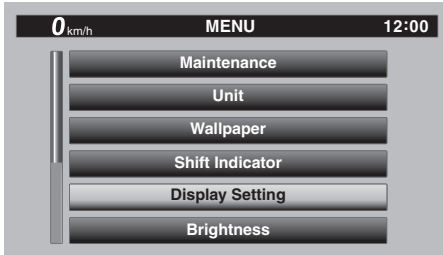

2. DISPLAY-1, DISPLAY-2, DISPLAY-3 and DISPLAY-4 are displayed.
3. For example, let's select DISPLAY-1. 1-1 and 1-2 are displayed.

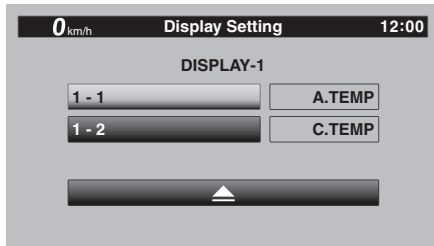

4. Select 1-1.

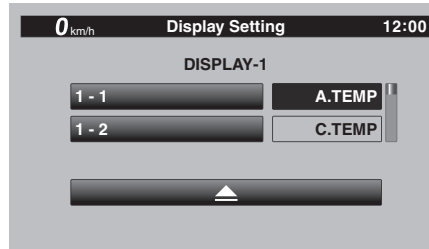

5. Select the desired information display item with the wheel switch.
 - A.TEMP: air temperature
 - C.TEMP: coolant temperature
 - TRIP-1: tripmeter 1
 - TRIP-2: tripmeter 2
 - ODO: odometer
 - FUEL CON: the amount of fuel consumed
 - FUEL AVG: average fuel consumption
 - CRNT FUEL: current fuel consumption
6. Select 1-2 to set the remaining DISPLAY-1 group item.

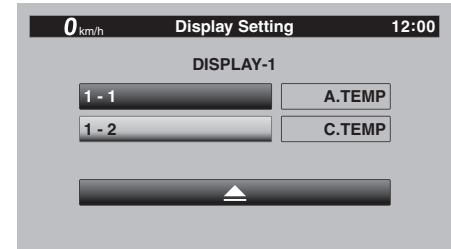

7. Select the triangle symbol to exit. To set the other display groups, repeat from step 3.

“Brightness”

This module allows you to adjust the general brightness level of the display screen.

To set the brightness

1. From the MENU screen, select “Brightness”.

Instrument and control functions

3



2. Select the desired brightness level by rotating the wheel switch, and then short push the wheel switch to fix the setting.

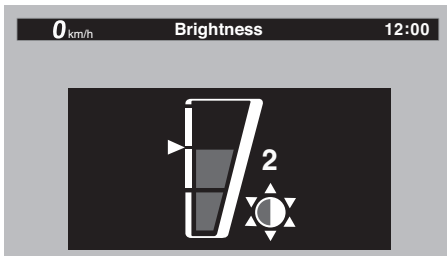

“Grip Warmer Setting”

This module allows you to set the low, middle, and high settings to 10 temperature levels.

To set the grip warmer temperature levels

1. From the MENU screen, select “Grip Warmer Setting”.



2. Select “LO”, “MIDDLE”, or “HIGH”.



3. Set the temperature level.



4. To set the temperature level for another grip warmer setting, repeat from step 2 or select the triangle symbol to exit this module.

“Clock”

This module allows you to set the clock.

To set the clock

1. From the MENU screen, select “Clock”.

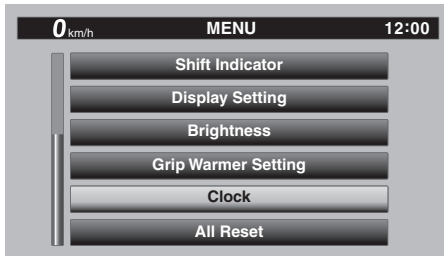

2. When “Clock” is selected, the hours figure will be highlighted.



3. Set the hour by rotating and then short push the wheel switch.



4. The minutes figure will become highlighted.

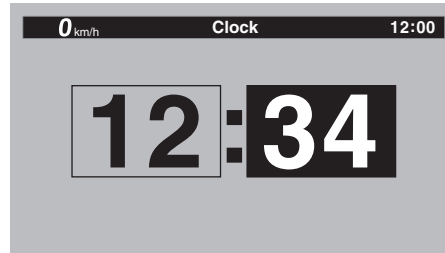

5. Set the minutes figure by rotating and then short push the wheel switch.

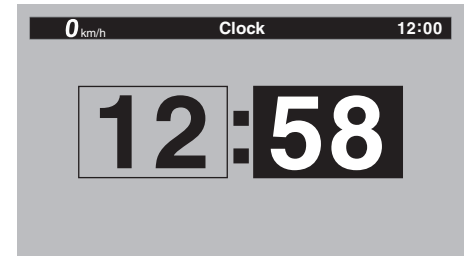

6. Short push the wheel switch again to exit and go back to the MENU screen.

“All Reset”

This module contains the all reset function which resets everything, except the odometer and clock, to its factory preset or default setting.

Select YES to reset all items. After selecting YES, all items will be reset and the display will automatically return to the MENU screen.

Instrument and control functions

3

D-mode (drive mode)

EAU84420

D-mode is an electronically controlled engine performance system with three mode selections: “STD”, “A”, and “B”. Push the drive mode switch “MODE” to switch between modes. (See page 3-4.)

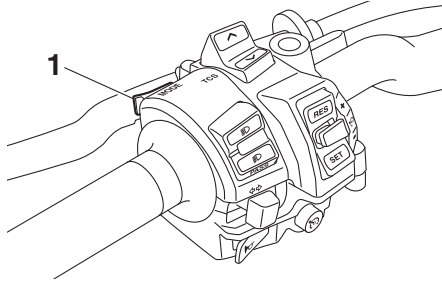

1. Drive mode switch “MODE”

TIP

Before using D-mode, make sure you understand its operation along with the operation of the drive mode switch.

Mode “STD”

Mode “STD” is suitable for various riding conditions.

This mode allows the rider to enjoy smooth and sporty drivability from the low-speed range to the high-speed range.

Mode “A”

Mode “A” offers a sportier engine response in the low- to mid-speed range compared to mode “STD”.

Mode “B”

Mode “B” offers response that is somewhat less sharp compared to mode “STD” for riding situations that require especially sensitive throttle operation.

Clutch lever

EAU12822

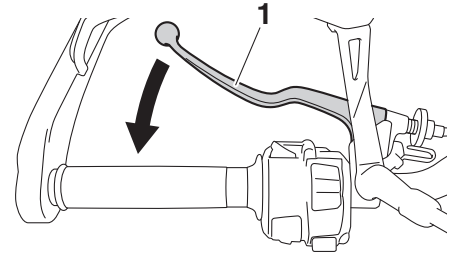

1. Clutch lever

The clutch lever is located on the left side of the handlebar. To disengage the clutch, pull the lever toward the handlebar grip. To engage the clutch, release the lever. The lever should be pulled rapidly and released slowly for smooth clutch operation.

The clutch lever is equipped with a clutch switch, which is part of the ignition circuit cut-off system. (See page 3-45.)

Shift pedal

EAU84321

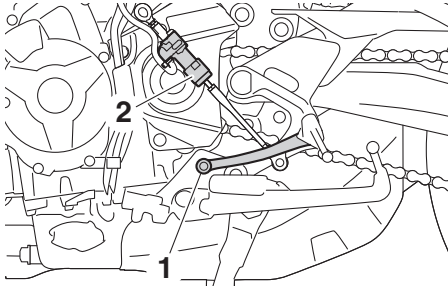

1. Shift pedal
2. Shift switch

The shift pedal is located on the left side of the engine. To shift the transmission to a higher gear, move the shift pedal up. To shift the transmission to a lower gear, move the shift pedal down. (See page 5-2.)

TIP

When the quick shift system is turned on, the shift switch senses shift pedal movement and allows for upshifting without operating the clutch lever.

Quick shift system

EAU84330

The quick shift system (QS) allows for full-throttle, clutch lever-less, electronically-assisted upshifts. When the shift switch detects motion in the shift pedal (page 3-26), engine power and drive torque are momentarily adjusted to allow the upshift to occur.

TIP

- The quick shift system operates when traveling at least 20 km/h (12 mi/h) with an engine speed of 2300 r/min or higher, and only when accelerating.
- It does not operate when the clutch lever is pulled.

Brake lever

EAU26826

The brake lever is located on the right side of the handlebar. To apply the front brake, pull the lever toward the throttle grip.

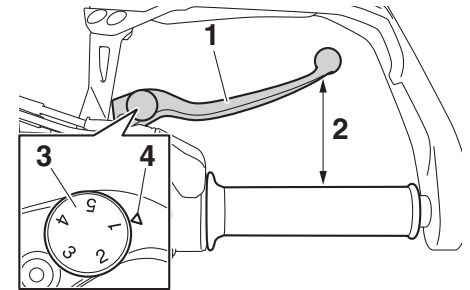

1. Brake lever
2. Distance
3. Brake lever position adjusting dial
4. Match mark

The brake lever is equipped with a brake lever position adjusting dial. To adjust the distance between the brake lever and the throttle grip, slightly pull the brake lever away from the throttle grip and rotate the adjusting dial. Make sure the setting number on the adjusting dial aligns with the match mark on the brake lever.

Instrument and control functions

3

Brake pedal

EAU12944

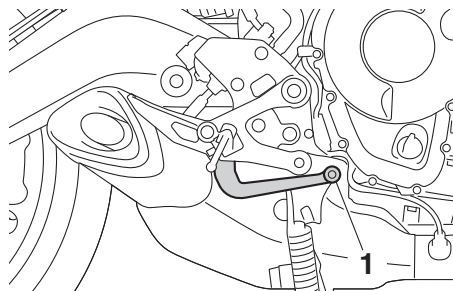

1. Brake pedal

The brake pedal is located on the right side of the motorcycle. To apply the rear brake, press down on the brake pedal.

ABS

EAU63040

The Yamaha ABS (Anti-lock Brake System) features a dual electronic control system, which acts on the front and rear brakes independently.

Operate the brakes with ABS as you would conventional brakes. If the ABS is activated, a pulsating sensation may be felt at the brake lever or brake pedal. In this situation, continue to apply the brakes and let the ABS work; do not “pump” the brakes as this will reduce braking effectiveness.

EWA16051

WARNING

Always keep a sufficient distance from the vehicle ahead to match the riding speed even with ABS.

- **The ABS performs best with long braking distances.**
- **On certain surfaces, such as rough or gravel roads, the braking distance may be longer with the ABS than without.**

The ABS is monitored by an ECU, which will revert the system to conventional braking if a malfunction occurs.

TIP

- The ABS performs a self-diagnosis test each time the vehicle first starts off after the key is turned to “ON” and the vehicle has traveled at a speed of 10 km/h (6 mi/h) or higher. During this test, a “clicking” noise can be heard from the hydraulic control unit, and if the brake lever or brake pedal is even slightly applied, a vibration can be felt at the lever and pedal, but these do not indicate a malfunction.
- This ABS has a test mode which allows the owner to experience the pulsation at the brake lever or brake pedal when the ABS is operating. However, special tools are required, so please consult your Yamaha dealer.

ECA20100

NOTICE

Be careful not to damage the wheel sensor or wheel sensor rotor; otherwise, improper performance of the ABS will result.

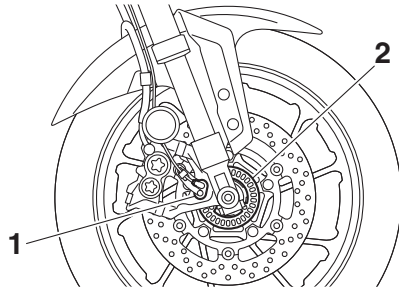

1. Front wheel sensor
2. Front wheel sensor rotor

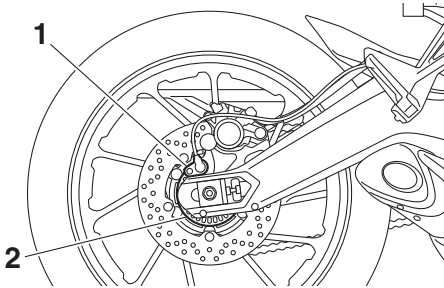

1. Rear wheel sensor
2. Rear wheel sensor rotor

Traction control system

EAU84342

The traction control system (TCS) helps maintain traction when accelerating on slippery surfaces, such as unpaved or wet roads. If sensors detect that the rear wheel is starting to slip (uncontrolled spinning), the traction control system assists by regulating engine power as needed until traction is restored.

⚠ WARNING

The traction control system is not a substitute for riding appropriately for the conditions. Traction control cannot prevent loss of traction due to excessive speed when entering turns, when accelerating hard at a sharp lean angle, or while braking, and cannot prevent front wheel slipping. As with any vehicle, approach surfaces that may be slippery with caution and avoid especially slippery surfaces.

EWA15433

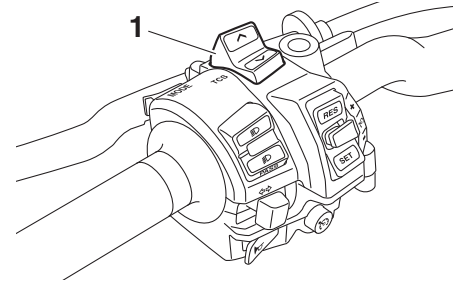

1. TCS switch “ \triangle / ∇ ”

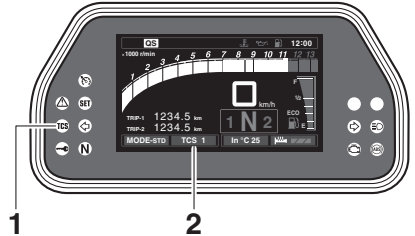

1. Traction control system indicator light “TCS”
2. TCS display

The “TCS” indicator light flashes when traction control has engaged. You may notice slight changes in engine and exhaust sounds when the system has engaged.

Instrument and control functions

3

The “tcs” indicator light comes on when traction control has been turned off.

The TCS display indicates the current TCS setting. There are three settings.

TCS “OFF”: Turns the traction control system off.

TCS “1”: Minimizes traction control system assist.

TCS “2”: Maximizes traction control assist; wheel spin is most strongly controlled.

TIP

- When the vehicle is turned on, traction control is turned on and set to “1” or “2” (whichever was last selected).
- Turn the traction control system off to help free the rear wheel if the vehicle gets stuck in mud, sand, or other soft surfaces.

ECA16801

NOTICE

Use only the specified tires. (See page 6-16.) Using different sized tires will prevent the traction control system from controlling tire rotation accurately.

Setting the traction control system

EWA15441

WARNING

Be sure to stop the vehicle before making any setting changes to the traction control system. Changing settings while riding can distract the operator and increase the risk of an accident.

TCS settings can be changed only when the vehicle is stopped and the throttle closed.

- Push the TCS switch “^” to change the TCS setting to TCS “1” and push the TCS switch “v” to change the TCS setting to TCS “2”.
- Push the TCS switch “^” for two seconds to turn the traction control system off.

- Push the TCS switch “v” to turn traction control back on (TCS will return to the previous setting).

Resetting the traction control system

The traction control system will automatically disable when:

- the front wheel or rear wheel comes off the ground while riding.
- excessive rear wheel spin is detected while riding.
- either wheel is rotated with the main switch turned on (such as when performing maintenance).

If the traction control system is disabled, both the “tcs” indicator light and the “⚠” warning light will come on.

4. Have a Yamaha dealer check the vehicle and turn off the “” warning light.

Fuel tank cap

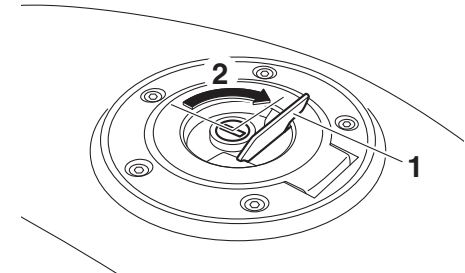

1. Fuel tank cap lock cover
2. Unlock.

To open the fuel tank cap

Open the fuel tank cap lock cover, insert the key into the lock, and then turn it 1/4 turn clockwise. The lock will be released and the fuel tank cap can be opened.

To close the fuel tank cap

With the key still inserted in the lock, push down the fuel tank cap. Turn the key 1/4 turn counterclockwise, remove it, and then close the lock cover.

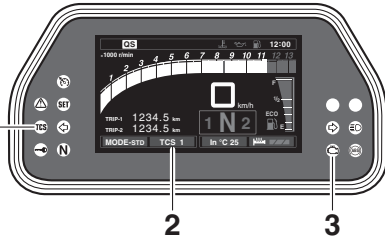

1. Traction control system indicator light “TCS”
2. TCS display
3. Engine “”

Should this occur, try resetting the system as follows.

1. Stop the vehicle and turn the main switch off.
2. Wait a few seconds and then turn the main switch on.
3. The “tcs” indicator light should turn off and the system be enabled.

TIP

If the “tcs” indicator light remains on after resetting, the vehicle may still be ridden; however, have a Yamaha dealer check the vehicle as soon as possible.

Instrument and control functions

TIP _____

The fuel tank cap cannot be closed unless the key is in the lock. In addition, the key cannot be removed if the cap is not properly closed and locked.

3

⚠ WARNING _____

EWA11092

Make sure that the fuel tank cap is properly closed after filling fuel. Leaking fuel is a fire hazard.

Fuel

EAU13222

Make sure there is sufficient gasoline in the tank.

EWA10882

⚠ WARNING _____

Gasoline and gasoline vapors are extremely flammable. To avoid fires and explosions and to reduce the risk of injury when refueling, follow these instructions.

1. Before refueling, turn off the engine and be sure that no one is sitting on the vehicle. Never refuel while smoking, or while in the vicinity of sparks, open flames, or other sources of ignition such as the pilot lights of water heaters and clothes dryers.
2. Do not overfill the fuel tank. When refueling, be sure to insert the pump nozzle into the fuel tank filler hole. Stop filling when the fuel reaches the bottom of the filler tube. Because fuel expands when it heats up, heat from the engine or the sun can cause fuel to spill out of the fuel tank.

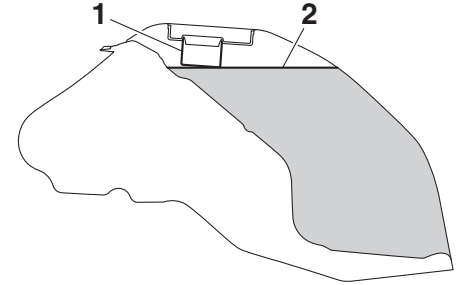

1. Fuel tank filler tube
2. Maximum fuel level

3. Wipe up any spilled fuel immediately. **NOTICE: Immediately wipe off spilled fuel with a clean, dry, soft cloth, since fuel may deteriorate painted surfaces or plastic parts.** [ECA10072]
4. Be sure to securely close the fuel tank cap.

EWA15152

⚠ WARNING _____

Gasoline is poisonous and can cause injury or death. Handle gasoline with care. Never siphon gasoline by mouth. If you should swallow some gasoline or inhale a lot of gasoline vapor, or get some gasoline in your eyes, see your doctor immediately. If

gasoline spills on your skin, wash with soap and water. If gasoline spills on your clothing, change your clothes.

EAU75300

Recommended fuel:

Premium unleaded gasoline (Gasohol [E10] acceptable)

Fuel tank capacity:

18 L (4.8 US gal, 4.0 Imp.gal)

Fuel reserve amount:

2.6 L (0.69 US gal, 0.57 Imp.gal)

ECA11401

NOTICE

Use only unleaded gasoline. The use of leaded gasoline will cause severe damage to internal engine parts, such as the valves and piston rings, as well as to the exhaust system.



TIP

- This mark identifies the recommended fuel for this vehicle as specified by European regulation (EN228).
- Check that gasoline nozzle has the same identifier when fueling.

Your Yamaha engine has been designed to use premium unleaded gasoline with a research octane number of 95 or higher. If knocking (or pinging) occurs, use a gasoline of a different brand. Use of unleaded fuel will extend spark plug life and reduce maintenance costs.

Gasohol

There are two types of gasohol: gasohol containing ethanol and that containing methanol. Gasohol containing ethanol can be used if the ethanol content does not exceed 10% (E10). Gasohol containing methanol is not recommended by Yamaha because it can cause damage to the fuel system or vehicle performance problems.

Instrument and control functions

Fuel tank overflow hose

EAU72972

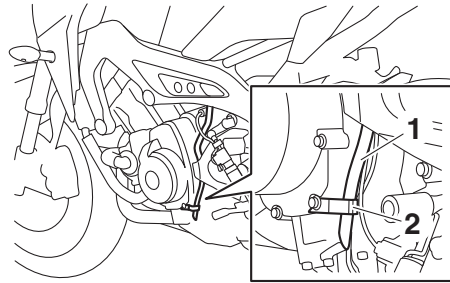

1. Fuel tank overflow hose
2. Clamp

Before operating the vehicle:

- Check the overflow hose connection and for damage.
- Confirm the overflow hose is not blocked and is routed through the clamp.

TIP

See page 6-11 for canister information.

Catalytic converter

EAU13434

This model is equipped with a catalytic converter in the exhaust system.

EWA10863

⚠ WARNING

The exhaust system is hot after operation. To prevent a fire hazard or burns:

- Do not park the vehicle near possible fire hazards such as grass or other materials that easily burn.
- Park the vehicle in a place where pedestrians or children are not likely to touch the hot exhaust system.
- Make sure that the exhaust system has cooled down before doing any maintenance work.
- Do not allow the engine to idle more than a few minutes. Long idling can cause a build-up of heat.

ECA10702

NOTICE

Use only unleaded gasoline. The use of leaded gasoline will cause unreparable damage to the catalytic converter.

Seats

EAU65801

Passenger seat

To remove the passenger seat

1. Insert the key into the seat lock, and then turn it counterclockwise.

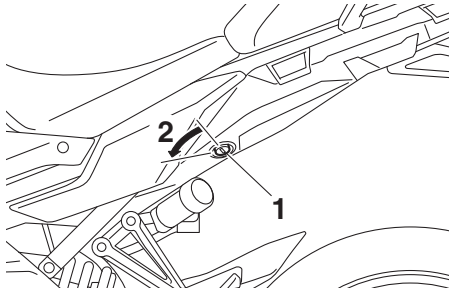

1. Seat lock
2. Unlock.

2. Lift the front of the passenger seat and pull it forward.

To install the passenger seat

1. Insert the projections on the rear of the passenger seat into the seat holders as shown, and then push the front of the seat down to lock it in place.

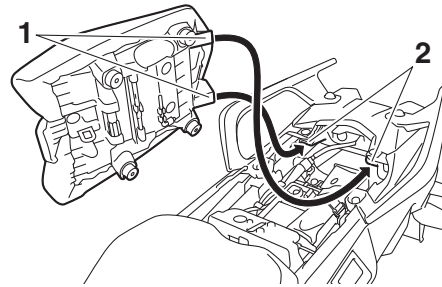

1. Projection
2. Seat holder

2. Remove the key.

Rider seat

To remove the rider seat

1. Remove the passenger seat.
2. Remove the cap, then push the rider seat lock lever, located under the back of the rider seat, to the left as shown, and then pull the seat off.

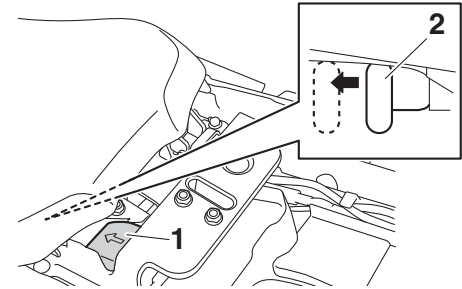

1. Cap
2. Rider seat lock lever

To install the rider seat

1. Install the cap with the arrow mark facing forward.
2. Insert the projection on the front of the rider seat into the seat holder as shown, and then push the rear of the seat down to lock it in place.

Instrument and control functions

3

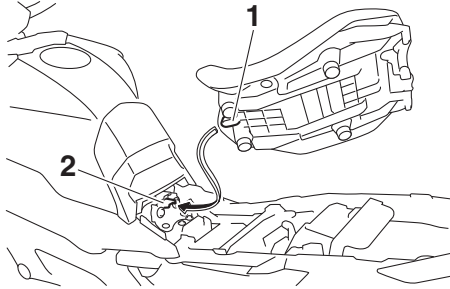

1. Projection
2. Seat holder

3. Install the passenger seat.

TIP

- Make sure that the seats are properly secured before riding.
- The rider seat height can be adjusted. See the following section.

Adjusting the rider seat height

EAU63051

The rider seat height can be adjusted to one of two positions. At factory assembly the rider seat height is set to the low position.

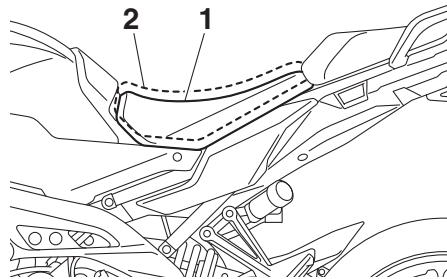

1. Low position
2. High position

To change to the high position

1. Remove the passenger seat and rider seat.
2. Remove the rider seat height position adjuster by pulling it upward.

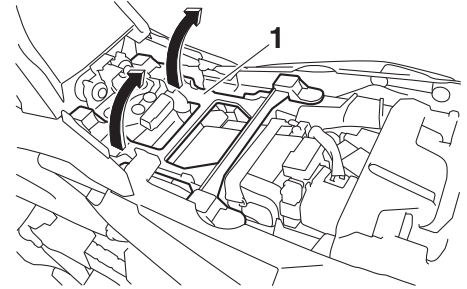

1. Rider seat height position adjuster

3. Install the rider seat height position adjuster by inserting the front projections into the grommets.

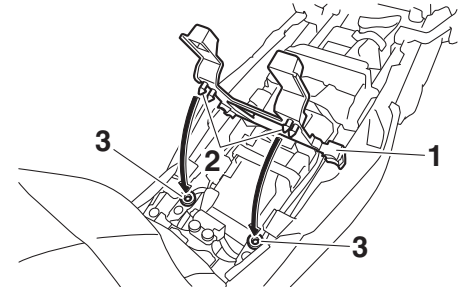

1. Rider seat height position adjuster
2. Projection
3. Grommet

Instrument and control functions

4. Insert the projection on the front of the rider seat into seat holder B as shown.

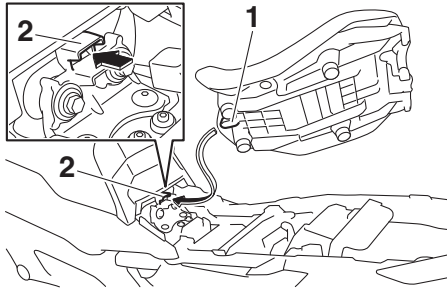

1. Projection
2. Seat holder B (for high position)

5. Align the projection on the bottom of the rider seat with the “H” position slot, and then push the rear of the seat down to lock it in place as shown.

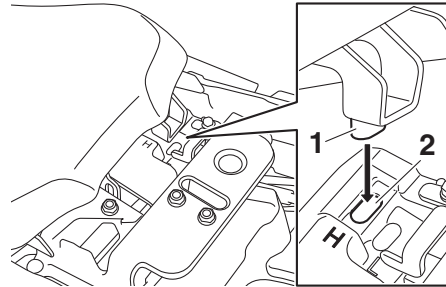

1. Projection
2. “H” position slot

6. Install the passenger seat.

To change to the low position

1. Remove the passenger seat and rider seat.
2. Remove the rider seat height position adjuster by pulling it upward.
3. Install the rider seat height position adjuster by inserting the rear projections into the grommets.

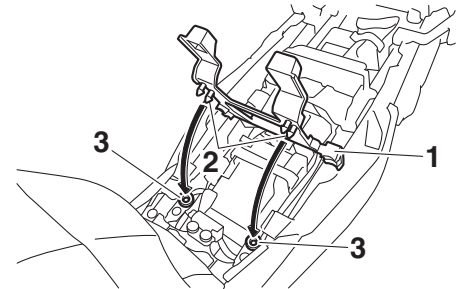

1. Rider seat height position adjuster
2. Projection
3. Grommet

4. Insert the projection on the front of the rider seat into seat holder A as shown.

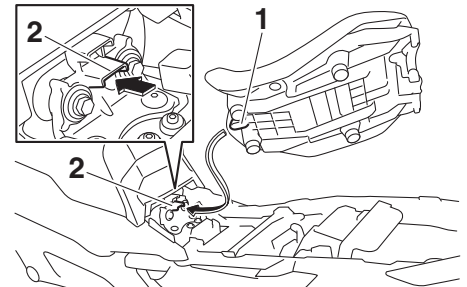

1. Projection
2. Seat holder A (for low position)

Instrument and control functions

- Align the projection on the bottom of the rider seat with the “L” position slot, and then push the rear of the seat down to lock it in place as shown.

3

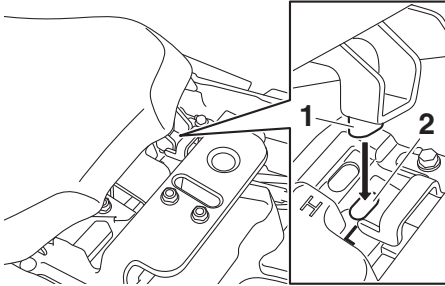

- Projection
- “L” position slot

- Install the passenger seat.

TIP

Make sure that the seats are properly secured before riding.

Helmet holder

EAU63062

The helmet holder is located under the passenger seat. A helmet holding cable is provided in the tool kit to secure a helmet to the helmet holder.

To secure a helmet

- Remove the passenger seat.
- Pass the helmet holding cable through the buckle on the helmet strap as shown, and then hook the cable loops over the helmet holder.

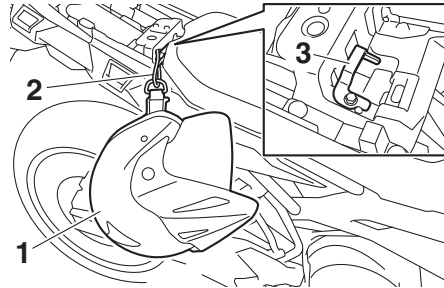

- Helmet
- Helmet holding cable
- Helmet holder

- Place the helmet on the right side of the vehicle, and then install the seat. **WARNING! Never ride with a helmet attached to the helmet holder, since the helmet may hit objects, causing loss of control and possibly an accident.** [EWA10162]

To release the helmet

Remove the passenger seat, remove the helmet holding cable from the helmet holder and the helmet, and then install the seat.

Storage compartment

EAU62550

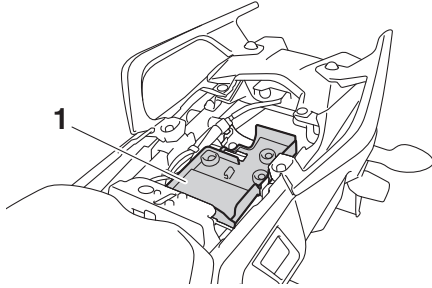

1. Storage compartment

The storage compartment is located under the passenger seat. (See page 3-34.)

When storing documents or other items in the storage compartment, be sure to wrap them in a plastic bag so that they will not get wet. When washing the vehicle, be careful not to let any water enter the storage compartment.

EWA15401



WARNING

Do not exceed the maximum load of 179 kg (395 lb) for the vehicle.

Windshield

EAU83932

This model is equipped with an adjustable windshield.

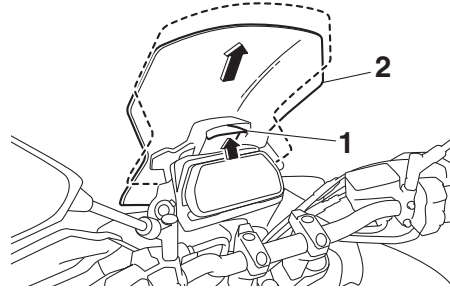

1. Windshield lock lever
2. Windshield

To change the position of the windshield, lift up the windshield lock lever and slide the windshield up or down. Release the lock lever when finished.

TIP

Make sure the windshield and lock lever are properly secured before riding.

Adjusting the headlight beams

EAU39612

The headlight beam adjusting knobs are used to raise or lower the height of the headlight beams. It may be necessary to adjust the headlight beams to increase visibility and help prevent blinding oncoming drivers when carrying more or less load than usual. Obey local laws and regulations when adjusting the headlights.

To raise the headlight beams, turn the knobs in direction (a). To lower the headlight beams, turn the knobs in direction (b).

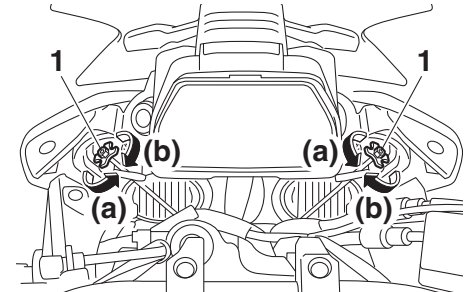

1. Headlight beam adjusting knob

Instrument and control functions

EAU46833

Handlebar position

The handlebar can be adjusted to one of two positions to suit the rider's preference. Have a Yamaha dealer adjust the position of the handlebar.

3

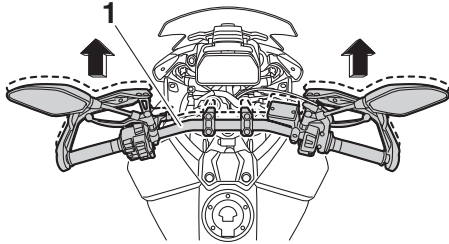

1. Handlebar

EAU76342

EWA14671

Adjusting the front fork

WARNING

Always adjust the spring preload on both fork legs equally, otherwise poor handling and loss of stability may result.

Each front fork leg is equipped with a spring preload adjusting bolt, the right front fork leg is equipped with a rebound damping force adjusting screw and the left front fork leg with a compression damping force adjusting screw.

ECA10102

NOTICE

To avoid damaging the mechanism, do not attempt to turn beyond the maximum or minimum settings.

Spring preload

To increase the spring preload and thereby harden the suspension, turn the adjusting bolt on each fork leg in direction (a). To decrease the spring pre-

load and thereby soften the suspension, turn the adjusting bolt on each fork leg in direction (b).

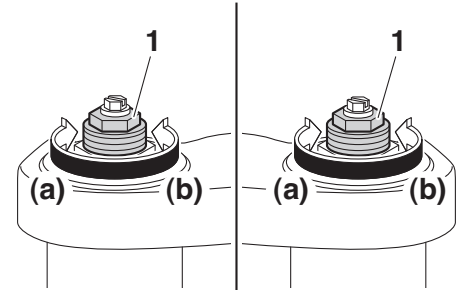

1. Spring preload adjusting bolt

The spring preload setting is determined by measuring distance A, shown in the illustration. The shorter distance A is, the higher the spring preload; the longer distance A is, the lower the spring preload.

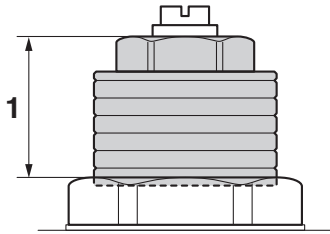

1. Distance A

Spring preload setting:
Minimum (soft):
Distance A = 19.0 mm (0.75 in)
Standard:
Distance A = 16.0 mm (0.63 in)
Maximum (hard):
Distance A = 4.0 mm (0.16 in)

Rebound damping force

The rebound damping force is adjusted on the right front fork leg only. To increase the rebound damping force and thereby harden the rebound damping, turn the adjusting screw in direction (a). To decrease the rebound damping force and thereby soften the rebound damping, turn the adjusting screw in direction (b).

TIP _____
Be sure to perform this adjustment on the right front fork leg.

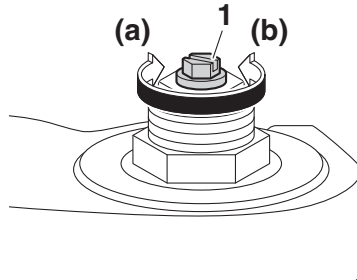

1. Rebound damping force adjusting screw

Rebound damping setting:
Minimum (soft):
11 click(s) in direction (b)
Standard:
7 click(s) in direction (b)
Maximum (hard):
1 click(s) in direction (b)

TIP _____
● When adjusting the damping force settings, turn the adjuster in direction (a) until it stops, and then count the clicks in direction (b).

● Although a damping force adjuster may click beyond the stated minimum settings, such adjustments are ineffective and may damage the suspension.

Compression damping force

The compression damping force is adjusted on the left front fork leg only. To increase the compression damping force and thereby harden the compression damping, turn the adjusting screw in direction (a). To decrease the compression damping force and thereby soften the compression damping, turn the adjusting screw in direction (b).

TIP _____
Be sure to perform this adjustment on the left front fork leg.

Instrument and control functions

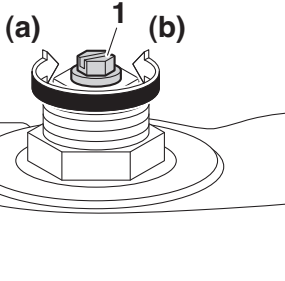

3

1. Compression damping force adjusting screw

Compression damping setting:

Minimum (soft):

11 click(s) in direction (b)

Standard:

7 click(s) in direction (b)

Maximum (hard):

1 click(s) in direction (b)

TIP

- When adjusting the damping force settings, turn the adjuster in direction (a) until it stops, and then count the clicks in direction (b).

- Although a damping force adjuster may click beyond the stated minimum settings, such adjustments are ineffective and may damage the suspension.
- When turning a damping force adjuster in direction (a), the 0 click position and the 1 click position may be the same.

EAU84350

Adjusting the shock absorber assembly

This shock absorber assembly is equipped with a spring preload adjusting knob and a rebound damping force adjusting screw.

ECA10102

NOTICE

To avoid damaging the mechanism, do not attempt to turn beyond the maximum or minimum settings.

Spring preload

To increase the spring preload and thereby harden the suspension, turn the adjusting knob in direction (a). To decrease the spring preload and thereby soften the suspension, turn the adjusting knob in direction (b).

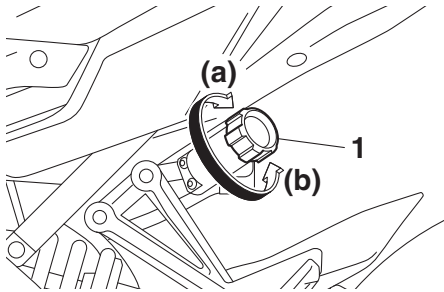

1. Spring preload adjusting knob

Spring preload setting:

Minimum (soft):

1 clicks in direction (a)

Standard:

11 clicks in direction (a)

Maximum (hard):

24 clicks in direction (a)

TIP

When adjusting the spring preload setting, turn the adjuster in direction (b) until it stops, and then count the clicks in direction (a).

Rebound damping force

To increase the rebound damping force and thereby harden the rebound damping, turn the adjusting screw in

direction (a). To decrease the rebound damping force and thereby soften the rebound damping, turn the adjusting screw in direction (b).

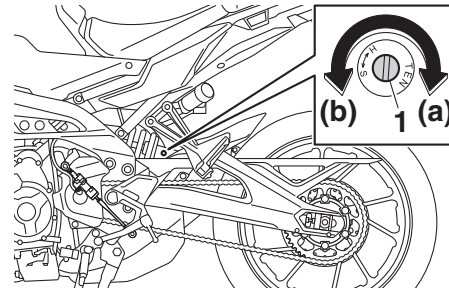

1. Rebound damping force adjusting screw

Rebound damping setting:

Minimum (soft):

18 clicks in direction (b)

Standard:

7 clicks in direction (b)

Maximum (hard):

1 clicks in direction (b)

TIP

- When adjusting the damping force settings, turn the adjuster in direction (a) until it stops, and then count the clicks in direction (b).

- Although a damping force adjuster may click beyond the stated minimum settings, such adjustments are ineffective and may damage the suspension.

⚠ WARNING

This shock absorber assembly contains highly pressurized nitrogen gas. Read and understand the following information before handling the shock absorber assembly.

- Do not tamper with or attempt to open the cylinder assembly.
- Do not subject the shock absorber assembly to an open flame or other high heat source. This may cause the unit to explode due to excessive gas pressure.
- Do not deform or damage the cylinder in any way. Cylinder damage will result in poor damping performance.

EWA10222

Instrument and control functions

- Do not dispose of a damaged or worn-out shock absorber assembly yourself. Take the shock absorber assembly to a Yamaha dealer for any service.

3

Auxiliary DC jack

EAU49454

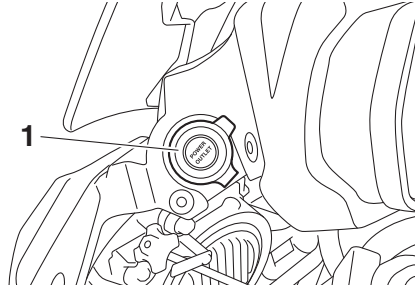

1. Auxiliary DC jack cap

A 12-V accessory connected to the auxiliary DC jack can be used when the main switch is on.

ECA15432

NOTICE

The accessory connected to the auxiliary DC jack should not be used with the engine turned off, and the load must never exceed 24 W (2 A), otherwise the fuse may blow or the battery may discharge.

To use the auxiliary DC jack

1. Turn the main switch off.
2. Remove the auxiliary DC jack cap.
3. Turn the accessory off.

4. Insert the accessory plug into the auxiliary DC jack.

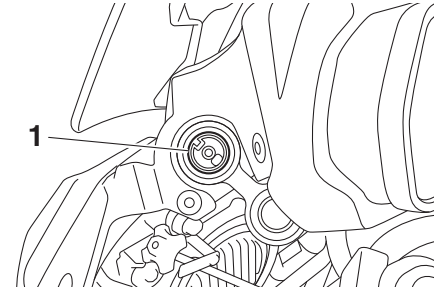

1. Auxiliary DC jack

5. Turn the main switch on, and start the engine. (See page 5-1.)
6. Turn the accessory on.

EWA14361

! WARNING

To prevent electrical shock or short-circuiting, make sure that the cap is installed when the auxiliary DC jack is not being used.

Auxiliary DC connector

EAU70641

This vehicle is equipped with an auxiliary DC connector. Consult your Yamaha dealer before installing any accessories.

Sidestand

EAU15306

The sidestand is located on the left side of the frame. Raise the sidestand or lower it with your foot while holding the vehicle upright.

TIP

The built-in sidestand switch is part of the ignition circuit cut-off system, which cuts the ignition in certain situations. (See the following section for an explanation of the ignition circuit cut-off system.)

EWA10242

WARNING

The vehicle must not be ridden with the sidestand down, or if the sidestand cannot be properly moved up (or does not stay up), otherwise the sidestand could contact the ground and distract the operator, resulting in a possible loss of control. Yamaha's ignition circuit cut-off system has been designed to assist the operator in fulfilling the responsibility of raising the sidestand before starting off. Therefore, check

this system regularly and have a Yamaha dealer repair it if it does not function properly.

Instrument and control functions

EAU57952

Ignition circuit cut-off system

This system prevents in-gear engine starts unless the clutch lever is pulled and the sidestand is up. Also, it will stop the running engine should the sidestand be lowered while the transmission is in gear.

Periodically check this system via the following procedure.

TIP

- This check is most reliable if performed with a warmed-up engine.
- See pages 3-2 and 3-3 for switch operation information.

Instrument and control functions

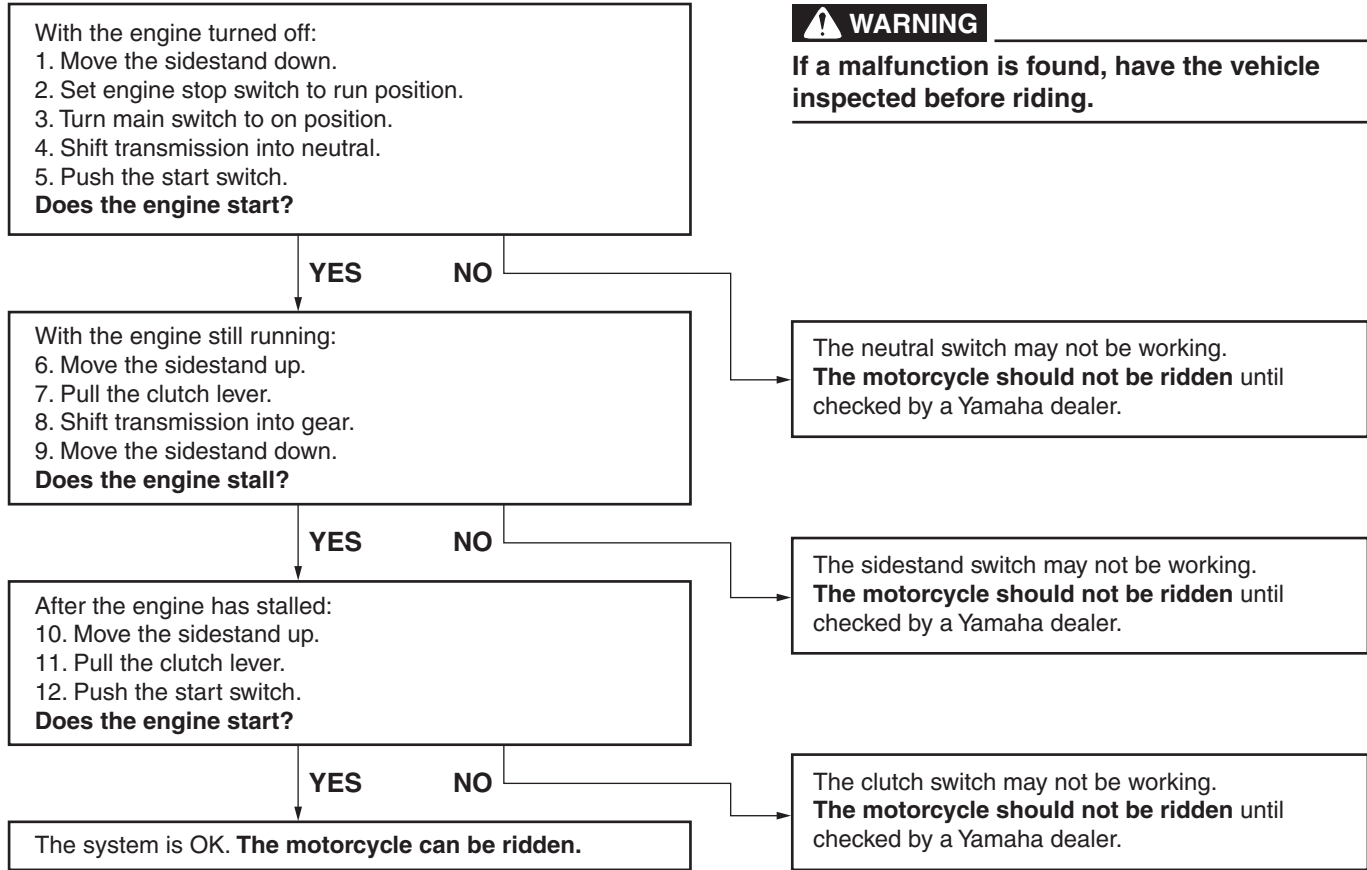

WARNING

If a malfunction is found, have the vehicle inspected before riding.

For your safety – pre-operation checks

EAU15599

Inspect your vehicle each time you use it to make sure the vehicle is in safe operating condition. Always follow the inspection and maintenance procedures and schedules described in the Owner's Manual.

EWA11152

WARNING

Failure to inspect or maintain the vehicle properly increases the possibility of an accident or equipment damage. Do not operate the vehicle if you find any problem. If a problem cannot be corrected by the procedures provided in this manual, have the vehicle inspected by a Yamaha dealer.

4

Before using this vehicle, check the following points:

ITEM	CHECKS	PAGE
Fuel	<ul style="list-style-type: none">• Check fuel level in fuel tank.• Refuel if necessary.• Check fuel line for leakage.• Check fuel tank overflow hose for obstructions, cracks or damage, and check hose connection.	3-31, 3-33
Engine oil	<ul style="list-style-type: none">• Check oil level in engine.• If necessary, add recommended oil to specified level.• Check vehicle for oil leakage.	6-11
Coolant	<ul style="list-style-type: none">• Check coolant level in reservoir.• If necessary, add recommended coolant to specified level.• Check cooling system for leakage.	6-14
Front brake	<ul style="list-style-type: none">• Check operation.• If soft or spongy, have Yamaha dealer bleed hydraulic system.• Check brake pads for wear.• Replace if necessary.• Check fluid level in reservoir.• If necessary, add specified brake fluid to specified level.• Check hydraulic system for leakage.	6-21, 6-21

For your safety – pre-operation checks

ITEM	CHECKS	PAGE
Rear brake	<ul style="list-style-type: none"> • Check operation. • If soft or spongy, have Yamaha dealer bleed hydraulic system. • Check brake pads for wear. • Replace if necessary. • Check fluid level in reservoir. • If necessary, add specified brake fluid to specified level. • Check hydraulic system for leakage. 	6-21, 6-21
Clutch	<ul style="list-style-type: none"> • Check operation. • Lubricate cable if necessary. • Check lever free play. • Adjust if necessary. 	6-19
Throttle grip	<ul style="list-style-type: none"> • Make sure that operation is smooth. • Check throttle grip free play. • If necessary, have Yamaha dealer adjust throttle grip free play and lubricate cable and grip housing. 	6-16, 6-26
Control cables	<ul style="list-style-type: none"> • Make sure that operation is smooth. • Lubricate if necessary. 	6-25
Drive chain	<ul style="list-style-type: none"> • Check chain slack. • Adjust if necessary. • Check chain condition. • Lubricate if necessary. 	6-23, 6-25
Wheels and tires	<ul style="list-style-type: none"> • Check for damage. • Check tire condition and tread depth. • Check air pressure. • Correct if necessary. 	6-16, 6-19
Brake and shift pedals	<ul style="list-style-type: none"> • Make sure that operation is smooth. • Lubricate pedal pivoting points if necessary. 	6-26
Brake and clutch levers	<ul style="list-style-type: none"> • Make sure that operation is smooth. • Lubricate lever pivoting points if necessary. 	6-27
Centerstand, sidestand	<ul style="list-style-type: none"> • Make sure that operation is smooth. • Lubricate pivots if necessary. 	6-27

For your safety – pre-operation checks

ITEM	CHECKS	PAGE
Chassis fasteners	<ul style="list-style-type: none">• Make sure that all nuts, bolts and screws are properly tightened.• Tighten if necessary.	–
Instruments, lights, signals and switches	<ul style="list-style-type: none">• Check operation.• Correct if necessary.	–
Sidestand switch	<ul style="list-style-type: none">• Check operation of ignition circuit cut-off system.• If system is not working correctly, have Yamaha dealer check vehicle.	3-44

Read the Owner's Manual carefully to become familiar with all controls. If there is a control or function you do not understand, ask your Yamaha dealer.

EWA10272

**WARNING**

Failure to familiarize yourself with the controls can lead to loss of control, which could cause an accident or injury.

TIP

This model is equipped with:

- a lean angle sensor. This sensor stops the engine in case of a vehicle turnover. If this happens, the engine trouble warning light will come on, but this is not a malfunction. Turn the vehicle power off and then back on again to cancel the warning light. Failing to do so will prevent the engine from starting even though the engine will crank when pushing the start switch.
- an engine auto-stop system. The engine stops automatically if left idling for 20 minutes. If the engine stops, simply push the start switch to restart the engine.

Starting the engine

Under normal conditions, shift the transmission into neutral before starting the engine. To start the engine with the transmission in gear, the sidestand must be up and the clutch lever pulled.

To start the engine

1. Turn the main switch to "ON", and set the engine stop switch to "○".
2. Confirm the following lights perform a circuit check.
 - Engine trouble warning light
 - ABS warning light
 - Traction control system indicator light
 - Cruise control indicator lights
 - Shift indicator light
 - Engine oil and Coolant warning light
 - Immobilizer system indicator light

TIP

- The ABS warning light should go off after reaching a speed of 10 km/h (6 mi/h) or higher.

Operation and important riding points

- The neutral position indicator light should be on when the transmission is in neutral.

ECA24110

NOTICE

If a warning or indicator light does not work as described above, have a Yamaha dealer check the vehicle.

3. Shift the transmission into neutral.
4. Push the start switch “

ECA11043

NOTICE

For maximum engine life, never accelerate hard when the engine is cold!

Shifting

EAU84370

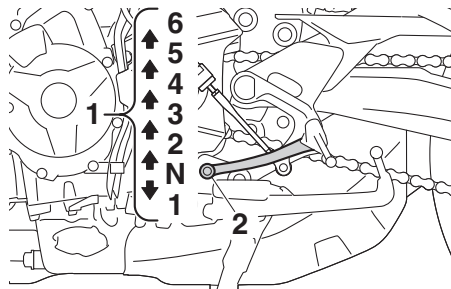

1. Gear positions
2. Shift pedal

Shifting gears lets you control the amount of engine power available for starting off, accelerating, climbing hills, etc.

The gear positions are shown in the illustration.

TIP

- To shift the transmission into the neutral position (N), press the shift pedal down repeatedly until it reaches the end of its travel, and then slightly raise it.

- This model is equipped with a quick shift system. (See page 3-26.)

ECA23990

NOTICE

- Even with the transmission in the neutral position, do not coast for long periods of time with the engine off, and do not tow the motorcycle for long distances. The transmission is properly lubricated only when the engine is running. Inadequate lubrication may damage the transmission.
- Except when upshifting with the quick shift system, always use the clutch while changing gears to avoid damaging the engine, transmission, and drive train, which are not designed to withstand the shock of forced shifting.

EAU85370

To start out and accelerate

1. Pull the clutch lever to disengage the clutch.

Operation and important riding points

2. Shift the transmission into first gear. The neutral indicator light should go out.
3. Open the throttle gradually, and at the same time, release the clutch lever slowly.
4. After starting out, close the throttle, and at the same time, quickly pull the clutch lever in.
5. Shift the transmission into second gear. (Make sure not to shift the transmission into the neutral position.)
6. Open the throttle part way and gradually release the clutch lever.
7. Follow the same procedure when shifting to the next higher gear.

EAU85380

To decelerate

1. Release the throttle and apply both the front and the rear brakes smoothly to slow the motorcycle.
2. As the vehicle decelerates, shift to a lower gear.

3. When the engine is about to stall or runs roughly, pull the clutch lever in, use the brakes to slow the motorcycle, and continue to downshift as necessary.
4. Once the motorcycle has stopped, the transmission can be shifted into the neutral position. The neutral indicator light should come on and then the clutch lever can be released.

EWA17380

WARNING

- **Improper braking can cause loss of control or traction. Always use both brakes and apply them smoothly.**
- **Make sure that the motorcycle and the engine have sufficiently slowed before shifting to a lower gear. Engaging a lower gear when the vehicle or engine speed is too high could make the rear wheel lose traction or the engine to over-rev. This could cause loss of control, an**

accident and injury. It could also cause engine or drive train damage.

Operation and important riding points

Tips for reducing fuel consumption

EAU16811

Fuel consumption depends largely on your riding style. Consider the following tips to reduce fuel consumption:

- Shift up swiftly, and avoid high engine speeds during acceleration.
- Do not rev the engine while shifting down, and avoid high engine speeds with no load on the engine.
- Turn the engine off instead of letting it idle for an extended length of time (e.g., in traffic jams, at traffic lights or at railroad crossings).

Engine break-in

EAU16842

There is never a more important period in the life of your engine than the period between 0 and 1600 km (1000 mi). For this reason, you should read the following material carefully.

Since the engine is brand new, do not put an excessive load on it for the first 1600 km (1000 mi). The various parts in the engine wear and polish themselves to the correct operating clearances. During this period, prolonged full-throttle operation or any condition that might result in engine overheating must be avoided.

EAU17094

0–1000 km (0–600 mi)

Avoid prolonged operation above 5600 r/min. **NOTICE: After 1000 km (600 mi) of operation, the engine oil must be changed and the oil filter cartridge or element replaced.** [ECA10303]

1000–1600 km (600–1000 mi)

Avoid prolonged operation above 6800 r/min.

1600 km (1000 mi) and beyond

The vehicle can now be operated normally.

ECA10311

NOTICE

- **Keep the engine speed out of the tachometer red zone.**
 - **If any engine trouble should occur during the engine break-in period, immediately have a Yamaha dealer check the vehicle.**
-

EAU17214

Parking

When parking, stop the engine, and then remove the key from the main switch.

EWA10312

WARNING

- **Since the engine and exhaust system can become very hot, park in a place where pedestrians or children are not likely to touch them and be burned.**
 - **Do not park on a slope or on soft ground, otherwise the vehicle may overturn, increasing the risk of a fuel leak and fire.**
 - **Do not park near grass or other flammable materials which might catch fire.**
-

Periodic maintenance and adjustment

EAU17246

EWA15123

EAU17303

Periodic inspection, adjustment, and lubrication will keep your vehicle in the safest and most efficient condition possible. Safety is an obligation of the vehicle owner/operator. The most important points of vehicle inspection, adjustment, and lubrication are explained on the following pages.

The intervals given in the periodic maintenance charts should be simply considered as a general guide under normal riding conditions. However, depending on the weather, terrain, geographical location, and individual use, the maintenance intervals may need to be shortened.

WARNING

EWA10322

Failure to properly maintain the vehicle or performing maintenance activities incorrectly may increase your risk of injury or death during service or while using the vehicle. If you are not familiar with vehicle service, have a Yamaha dealer perform service.

WARNING

Turn off the engine when performing maintenance unless otherwise specified.

- **A running engine has moving parts that can catch on body parts or clothing and electrical parts that can cause shocks or fires.**
- **Running the engine while servicing can lead to eye injury, burns, fire, or carbon monoxide poisoning – possibly leading to death. See page 1-3 for more information about carbon monoxide.**

WARNING

EWA15461

Brake discs, calipers, drums, and linings can become very hot during use. To avoid possible burns, let brake components cool before touching them.

Emission controls not only function to ensure cleaner air, but are also vital to proper engine operation and maximum performance. In the following periodic maintenance charts, the services related to emissions control are grouped separately. These services require specialized data, knowledge, and equipment. Maintenance, replacement, or repair of the emission control devices and systems may be performed by any repair establishment or individual that is certified (if applicable). Yamaha dealers are trained and equipped to perform these particular services.

Tool kit

EAU85230

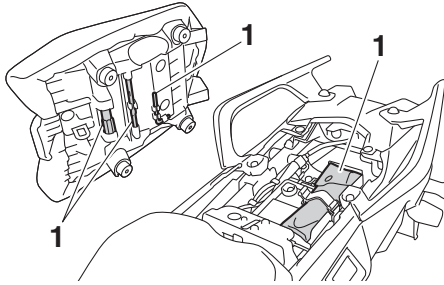

1. Tool kit

The tool kit is in the location shown. The information included in this manual and the tools provided in the tool kit are intended to assist you in the performance of preventive maintenance and minor repairs. However, a torque wrench and other tools are necessary to perform certain maintenance work correctly.

TIP _____

If you do not have the tools or experience required for a particular job, have your Yamaha dealer perform it for you.

Periodic maintenance and adjustment

EAU71033

Periodic maintenance charts

TIP

- Items marked with an asterisk should be performed by your Yamaha dealer because these items require special tools, data, and technical skills.
- From 50000 km (30000 mi), repeat the maintenance intervals starting from 10000 km (6000 mi).
- **The annual checks must be performed every year, except if a distance-based maintenance is performed instead.**

EAU71051

Periodic maintenance chart for the emission control system

NO.	ITEM	CHECK OR MAINTENANCE JOB	ODOMETER READING					ANNUAL CHECK
			1000 km (600 mi)	10000 km (6000 mi)	20000 km (12000 mi)	30000 km (18000 mi)	40000 km (24000 mi)	
1	* Fuel line	<ul style="list-style-type: none"> • Check fuel hoses for cracks or damage. • Replace if necessary. 		√	√	√	√	√
2	* Spark plugs	<ul style="list-style-type: none"> • Check condition. • Adjust gap and clean. 		√		√		
		<ul style="list-style-type: none"> • Replace. 			√		√	
3	* Valve clearance	<ul style="list-style-type: none"> • Check and adjust. 	Every 40000 km (24000 mi)					
4	* Fuel injection	<ul style="list-style-type: none"> • Check engine idle speed. 	√	√	√	√	√	√
		<ul style="list-style-type: none"> • Check and adjust synchronization. 		√	√	√	√	√
5	* Exhaust system	<ul style="list-style-type: none"> • Check for leakage. • Tighten if necessary. • Replace gaskets if necessary. 	√	√	√	√	√	

Periodic maintenance and adjustment

NO.	ITEM	CHECK OR MAINTENANCE JOB	ODOMETER READING					ANNUAL CHECK
			1000 km (600 mi)	10000 km (6000 mi)	20000 km (12000 mi)	30000 km (18000 mi)	40000 km (24000 mi)	
6	* Evaporative emission control system	<ul style="list-style-type: none"> • Check control system for damage. • Replace if necessary. 			√		√	
7	* Air induction system	<ul style="list-style-type: none"> • Check the air cut-off valve, reed valve, and hose for damage. • Replace any damaged parts if necessary. 		√	√	√	√	√

Periodic maintenance and adjustment

EAU71352

General maintenance and lubrication chart

NO.	ITEM	CHECK OR MAINTENANCE JOB	ODOMETER READING					ANNUAL CHECK
			1000 km (600 mi)	10000 km (6000 mi)	20000 km (12000 mi)	30000 km (18000 mi)	40000 km (24000 mi)	
1	* Diagnostic system check	<ul style="list-style-type: none"> Perform dynamic inspection using Yamaha diagnostic tool. Check the error codes. 	√	√	√	√	√	√
2	* Air filter element	<ul style="list-style-type: none"> Replace. 	Every 40000 km (24000 mi)					
3	Clutch	<ul style="list-style-type: none"> Check operation. Adjust. 	√	√	√	√	√	
4	* Front brake	<ul style="list-style-type: none"> Check operation, fluid level, and for fluid leakage. Replace brake pads if necessary. 	√	√	√	√	√	√
5	* Rear brake	<ul style="list-style-type: none"> Check operation, fluid level, and for fluid leakage. Replace brake pads if necessary. 	√	√	√	√	√	√
6	* Brake hoses	<ul style="list-style-type: none"> Check for cracks or damage. Replace. 		√	√	√	√	√
7	* Brake fluid	<ul style="list-style-type: none"> Change. 	Every 2 years					
8	* Wheels	<ul style="list-style-type: none"> Check runout and for damage. Replace if necessary. 		√	√	√	√	
9	* Tires	<ul style="list-style-type: none"> Check tread depth and for damage. Replace if necessary. Check air pressure. Correct if necessary. 		√	√	√	√	√
10	* Wheel bearings	<ul style="list-style-type: none"> Check bearing for looseness or damage. 		√	√	√	√	

6

Periodic maintenance and adjustment

NO.	ITEM	CHECK OR MAINTENANCE JOB	ODOMETER READING					ANNUAL CHECK
			1000 km (600 mi)	10000 km (6000 mi)	20000 km (12000 mi)	30000 km (18000 mi)	40000 km (24000 mi)	
11	* Swingarm pivot bearings	• Check operation and for excessive play.		√	√	√	√	
		• Lubricate with lithium-soap-based grease.	Every 50000 km (30000 mi)					
12	Drive chain	<ul style="list-style-type: none"> • Check chain slack, alignment and condition. • Adjust and lubricate chain with a special O-ring chain lubricant thoroughly. 	Every 1000 km (600 mi) and after washing the motorcycle, riding in the rain or riding in wet areas					
13	* Steering bearings	• Check bearing assemblies for looseness.	√	√		√		
		• Moderately repack with lithium-soap-based grease.			√		√	
14	* Chassis fasteners	• Make sure that all nuts, bolts and screws are properly tightened.		√	√	√	√	√
15	Brake lever pivot shaft	• Lubricate with silicone grease.		√	√	√	√	√
16	Brake pedal pivot shaft	• Lubricate with lithium-soap-based grease.		√	√	√	√	√
17	Clutch lever pivot shaft	• Lubricate with lithium-soap-based grease.		√	√	√	√	√
18	Shift pedal pivot shaft	• Lubricate with lithium-soap-based grease.		√	√	√	√	√
19	Sidestand, center-stand	<ul style="list-style-type: none"> • Check operation. • Lubricate with lithium-soap-based grease. 		√	√	√	√	√

Periodic maintenance and adjustment

NO.	ITEM	CHECK OR MAINTENANCE JOB	ODOMETER READING					ANNUAL CHECK
			1000 km (600 mi)	10000 km (6000 mi)	20000 km (12000 mi)	30000 km (18000 mi)	40000 km (24000 mi)	
20	* Sidestand switch	<ul style="list-style-type: none"> Check operation and replace if necessary. 	√	√	√	√	√	√
21	* Front fork	<ul style="list-style-type: none"> Check operation and for oil leakage. Replace if necessary. 		√	√	√	√	
22	* Shock absorber assembly	<ul style="list-style-type: none"> Check operation and for oil leakage. Replace if necessary. 		√	√	√	√	
23	* Rear suspension relay arm and connecting arm pivoting points	<ul style="list-style-type: none"> Check operation. 		√	√	√	√	
24	Engine oil	<ul style="list-style-type: none"> Change (warm engine before draining). Check oil level and vehicle for oil leakage. 	√	√	√	√	√	√
25	Engine oil filter cartridge	<ul style="list-style-type: none"> Replace. 	√		√		√	
26	* Cooling system	<ul style="list-style-type: none"> Check coolant level and vehicle for coolant leakage. 		√	√	√	√	√
		<ul style="list-style-type: none"> Change. 	Every 3 years					
27	* Front and rear brake switches	<ul style="list-style-type: none"> Check operation. 	√	√	√	√	√	√
28	* Moving parts and cables	<ul style="list-style-type: none"> Lubricate. 		√	√	√	√	√

Periodic maintenance and adjustment

NO.	ITEM	CHECK OR MAINTENANCE JOB	ODOMETER READING					ANNUAL CHECK
			1000 km (600 mi)	10000 km (6000 mi)	20000 km (12000 mi)	30000 km (18000 mi)	40000 km (24000 mi)	
29	* Throttle grip housing and cable	<ul style="list-style-type: none"> • Check operation and free play. • Adjust the throttle cable free play if necessary. • Lubricate the throttle grip housing, cable and grip warmer wire. 		√	√	√	√	√
30	* Lights, signals and switches	<ul style="list-style-type: none"> • Check operation. • Adjust headlight beam. 	√	√	√	√	√	√

EAU72800

TIP

- Air filter
 - This model's air filter is equipped with a disposable oil-coated paper element, which must not be cleaned with compressed air to avoid damaging it.
 - The air filter element needs to be replaced more frequently when riding in unusually wet or dusty areas.
- Hydraulic brake service
 - Regularly check and, if necessary, correct the brake fluid level.
 - Every two years replace the internal components of the brake master cylinders and calipers, and change the brake fluid.
 - Replace the brake hoses every four years and if cracked or damaged.

Periodic maintenance and adjustment

Removing and installing the panel

EAU18752

The panel shown needs to be removed to perform some of the maintenance jobs described in this chapter. Refer to this section each time the panel needs to be removed and installed.

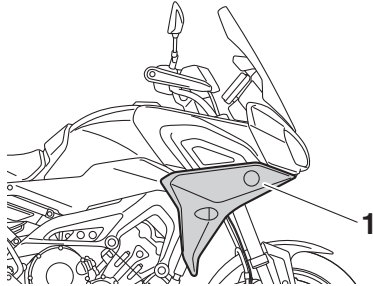

1. Panel A

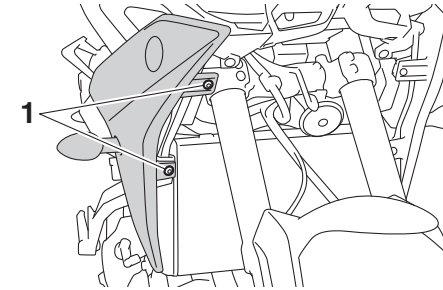

1. Quick fastener screw

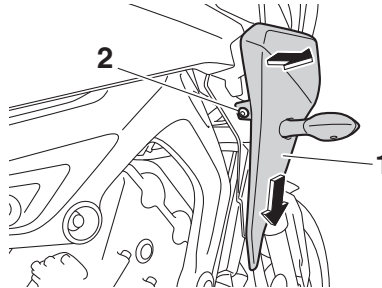

1. Panel A
2. Quick fastener screw

2. Disconnect the turn signal light lead coupler.

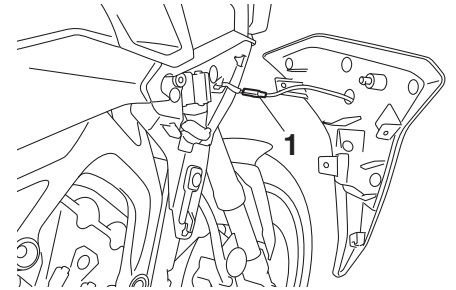

1. Turn signal light lead coupler

To install the panel

1. Connect the turn signal light lead coupler.
2. Place the panel in the original position, and then install the quick fastener screws.

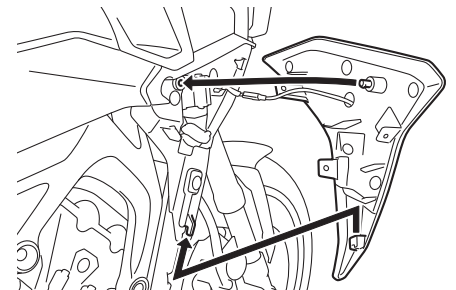

EAU63101

Panel A

To remove the panel

1. Remove the quick fastener screws, and then pull the panel outward and slide it downward as shown.

Periodic maintenance and adjustment

Checking the spark plugs

EAU19653

The spark plugs are important engine components, which should be checked periodically, preferably by a Yamaha dealer. Since heat and deposits will cause any spark plug to slowly erode, they should be removed and checked in accordance with the periodic maintenance and lubrication chart. In addition, the condition of the spark plugs can reveal the condition of the engine.

The porcelain insulator around the center electrode of each spark plug should be a medium-to-light tan (the ideal color when the vehicle is ridden normally), and all spark plugs installed in the engine should have the same color. If any spark plug shows a distinctly different color, the engine could be operating improperly. Do not attempt to diagnose such problems yourself. Instead, have a Yamaha dealer check the vehicle.

If a spark plug shows signs of electrode erosion and excessive carbon or other deposits, it should be replaced.

Specified spark plug:
NGK/CPR9EA9

Before installing a spark plug, the spark plug gap should be measured with a wire thickness gauge and, if necessary, adjusted to specification.

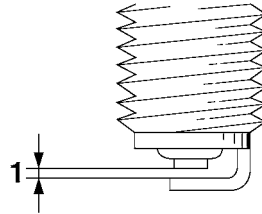

1. Spark plug gap

Spark plug gap:
0.8–0.9 mm (0.031–0.035 in)

Clean the surface of the spark plug gasket and its mating surface, and then wipe off any grime from the spark plug threads.

Tightening torque:
Spark plug:
13 N·m (1.3 kgf·m, 9.6 lb·ft)

TIP

If a torque wrench is not available when installing a spark plug, a good estimate of the correct torque is 1/4–1/2 turn past finger tight. However, the spark plug should be tightened to the specified torque as soon as possible.

ECA10841

NOTICE

Do not use any tools to remove or install the spark plug cap, otherwise the ignition coil coupler may get damaged. The spark plug cap may be difficult to remove because the rubber seal on the end of the cap fits tightly. To remove the spark plug cap, simply twist it back and forth while pulling it out; to install it, twist it back and forth while pushing it in.

Periodic maintenance and adjustment

Canister

EAU36112

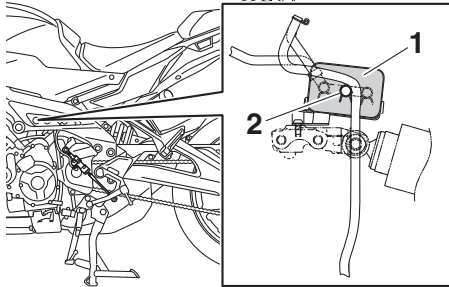

1. Canister
2. Canister breather

6

This model is equipped with a canister to prevent the discharging of fuel vapor into the atmosphere. Before operating this vehicle, make sure to check the following:

- Check each hose connection.
- Check each hose and canister for cracks or damage. Replace if damaged.
- Make sure that the canister breather is not blocked, and if necessary, clean it.

Engine oil

EAU1990G

The engine oil level should be checked regularly. In addition, the oil must be changed and the oil filter cartridge replaced at the intervals specified in the periodic maintenance chart.

Recommended engine oil:

See page 8-1.

Oil quantity:

Oil change:

2.40 L (2.54 US qt, 2.11 Imp.qt)

With oil filter removal:

2.70 L (2.85 US qt, 2.38 Imp.qt)

ECA11621

NOTICE

- **In order to prevent clutch slippage (since the engine oil also lubricates the clutch), do not mix any chemical additives. Do not use oils with a diesel specification of “CD” or oils of a higher quality than specified. In addition, do not use oils labeled “ENERGY CONSERVING II” or higher.**
- **Make sure that no foreign material enters the crankcase.**

To check the engine oil level

1. After warming up the engine, wait a few minutes for the oil level to settle for an accurate reading.
2. With the vehicle on a level surface, hold it upright for an accurate reading.
3. Look at the check window located at the bottom-right side of the crankcase.

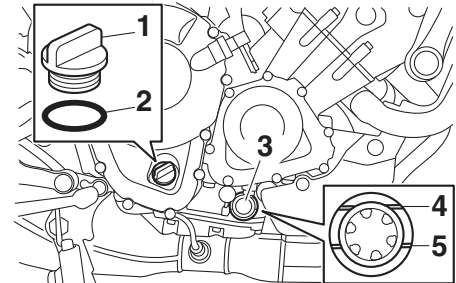

1. Engine oil filler cap
2. O-ring
3. Engine oil level check window
4. Maximum level mark
5. Minimum level mark

TIP

The engine oil should be between the minimum and maximum level marks.

Periodic maintenance and adjustment

- If the engine oil is at or below the minimum level mark, remove the oil filler cap and add oil.
- Check the engine oil filler cap O-ring. Replace if damaged.

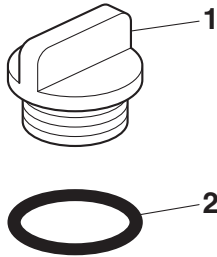

- Engine oil filler cap
- O-ring

6. Install the engine oil filler cap.

To change the engine oil (and filter)

- Start the engine and allow it to idle for a few minutes to warm up the oil, and then stop the engine.
- Place an oil pan under the engine to collect the used oil.
- Remove the engine oil filler cap, and then the engine oil drain bolt and gasket.

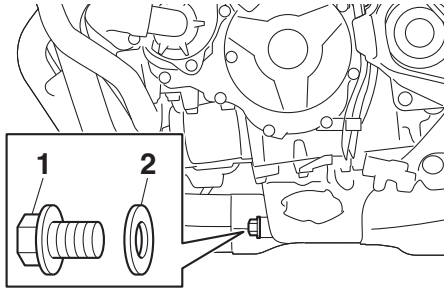

- Engine oil drain bolt
- Gasket

TIP

Skip steps 4–6 if the oil filter cartridge is not being replaced.

- Remove the oil filter cartridge with an oil filter wrench.

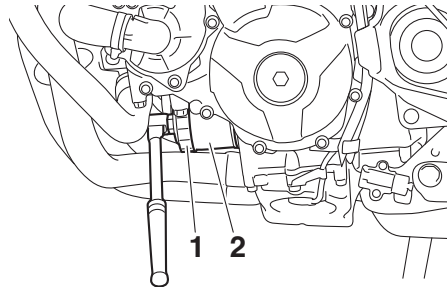

- Oil filter wrench
- Oil filter cartridge

TIP

An oil filter wrench is available at a Yamaha dealer.

- Apply a thin coat of clean engine oil to the O-ring of the new oil filter cartridge.

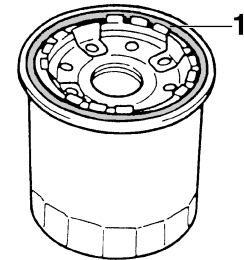

- O-ring

TIP

Make sure that the O-ring is properly seated.

- Install the new oil filter cartridge, and then tighten to the specified torque.

Periodic maintenance and adjustment

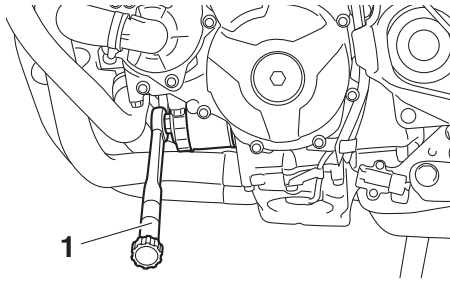

1. Torque wrench

Tightening torque:

Oil filter cartridge:
17 N·m (1.7 kgf·m, 13 lb·ft)

7. Install the engine oil drain bolt with a new gasket, and then tighten the bolt to the specified torque.

Tightening torque:

Engine oil drain bolt:
43 N·m (4.3 kgf·m, 32 lb·ft)

8. Pour the specified amount of the recommended oil into the crankcase.

TIP _____

Using a funnel is recommended.

9. After checking the engine oil filler cap O-ring, install the filler cap.

TIP _____

Wipe off any spilled oil before starting the engine.

10. Start the engine and let it idle while checking for oil leaks.

TIP _____

If any oil leaks are found which you cannot fix, have the vehicle inspected.

11. Stop the engine, wait a few minutes for the oil level to settle, and then check the oil level one last time. **NOTICE: Do not operate the vehicle until you know that the engine oil level is sufficient.**

[ECA10012]

EAU85450

Why Yamalube

YAMALUBE oil is a Genuine YAMAHA Part born of the engineers' passion and belief that engine oil is an important liquid engine component. We form teams of specialists in the fields of mechanical engineering, chemistry, electronics and track testing, and have them develop the engine together with the oil it will use. Yamalube oils take full advantage of the base oil's qualities and blend in the ideal balance of additives to make sure the final oil clears our performance standards. Thus, Yamalube mineral, semisynthetic and synthetic oils have their own distinct characters and value. Yamaha's experience gained over many years of research and development into oil since the 1960's helps make Yamalube the best choice for your Yamaha engine.

YAMALUBE®

Periodic maintenance and adjustment

Coolant

The coolant level should be checked regularly. In addition, the coolant must be changed at the intervals specified in the periodic maintenance chart.

EAUS1203

Recommended coolant:

YAMALUBE coolant

Coolant quantity:

Coolant reservoir (max level mark):
0.25 L (0.26 US qt, 0.22 Imp.qt)

Radiator (including all routes):
1.93 L (2.04 US qt, 1.70 Imp.qt)

TIP

If genuine Yamaha coolant is not available, use an ethylene glycol antifreeze containing corrosion inhibitors for aluminum engines and mix with distilled water at a 1:1 ratio.

EAU20097

To check the coolant level

Since the coolant level varies with engine temperature, check when the engine is cold.

1. Park the vehicle on a level surface.

2. With the vehicle in an upright position, look at the coolant level in the reservoir.

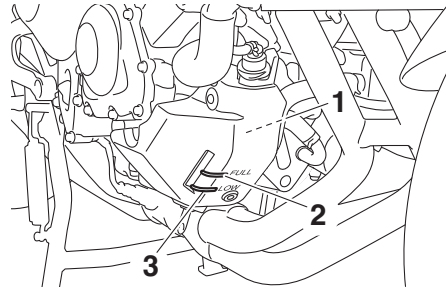

1. Coolant reservoir
2. Maximum level mark
3. Minimum level mark

3. If the coolant is at or below the minimum level mark, remove the coolant reservoir cap. **WARNING! Remove only the coolant reservoir cap. Never attempt to remove the radiator cap when the engine is hot.** [EWA15162]

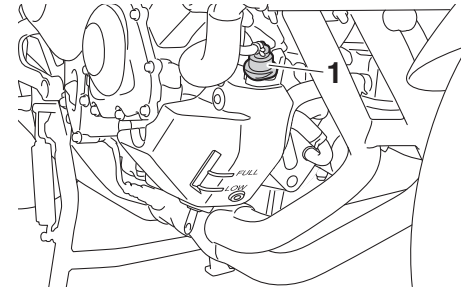

1. Coolant reservoir cap

4. Add coolant to the maximum level mark. **NOTICE: If coolant is not available, use distilled water or soft tap water instead. Do not use hard water or salt water since it is harmful to the engine. If water has been used instead of coolant, replace it with coolant as soon as possible, otherwise the cooling system will not be protected against frost and corrosion. If water has been added to the coolant, have a Yamaha dealer check the antifreeze content of the coolant as soon as possible, otherwise the effectiveness of the coolant will be reduced.** [ECA10473]

Periodic maintenance and adjustment

5. Install the coolant reservoir cap.

EAU33032

Changing the coolant

The coolant must be changed at the intervals specified in the periodic maintenance and lubrication chart. Have a Yamaha dealer change the coolant.

WARNING! Never attempt to remove the radiator cap when the engine is hot. [EWA10382]

Air filter element

EAU36765

The air filter element must be replaced at the intervals specified in the periodic maintenance and lubrication chart. Have a Yamaha dealer replace the air filter element.

Checking the engine idling speed

EAU44735

Check the engine idling speed and, if necessary, have it corrected by a Yamaha dealer.

Engine idling speed:
1100–1300 r/min

Checking the throttle grip free play

EAU21386

Measure the throttle grip free play as shown.

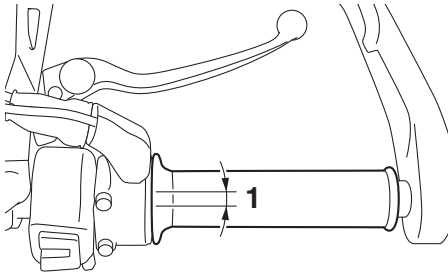

1. Throttle grip free play

Throttle grip free play:
3.0–5.0 mm (0.12–0.20 in)

Periodically check the throttle grip free play and, if necessary, have a Yamaha dealer adjust it.

Valve clearance

EAU21403

The valves are an important engine component, and since valve clearance changes with use, they must be checked and adjusted at the intervals specified in the periodic maintenance chart. Unadjusted valves can result in improper air-fuel mixture, engine noise, and eventually engine damage. To prevent this from occurring, have your Yamaha dealer check and adjust the valve clearance at regular intervals.

TIP

This service must be performed when the engine is cold.

Tires

EAU64412

Tires are the only contact between the vehicle and the road. Safety in all conditions of riding depends on a relatively small area of road contact. Therefore, it is essential to maintain the tires in good condition at all times and replace them at the appropriate time with the specified tires.

Tire air pressure

The tire air pressure should be checked and, if necessary, adjusted before each ride.

EWA10504

WARNING

Operation of this vehicle with improper tire pressure may cause severe injury or death from loss of control.

- The tire air pressure must be checked and adjusted on cold tires (i.e., when the temperature of the tires equals the ambient temperature).
- The tire air pressure must be adjusted in accordance with the riding speed and with the total

Periodic maintenance and adjustment

EWA10472

weight of rider, passenger, cargo, and accessories approved for this model.

Cold tire air pressure:

1 person:

Front:

225 kPa (2.25 kgf/cm², 33 psi)

Rear:

250 kPa (2.50 kgf/cm², 36 psi)

2 persons:

Front:

250 kPa (2.50 kgf/cm², 36 psi)

Rear:

290 kPa (2.90 kgf/cm², 42 psi)

Maximum load:

Vehicle:

179 kg (395 lb)

The vehicle's maximum load is the combined weight of the rider, passenger, cargo, and any accessories.

EWA10512



WARNING

Never overload your vehicle. Operation of an overloaded vehicle could cause an accident.

Tire inspection

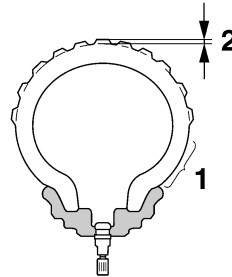

1. Tire sidewall
2. Tire tread depth

The tires must be checked before each ride. If the center tread depth reaches the specified limit, if the tire has a nail or glass fragments in it, or if the sidewall is cracked, have a Yamaha dealer replace the tire immediately.

Minimum tire tread depth (front and rear):

1.6 mm (0.06 in)

TIP

The tire tread depth limits may differ from country to country. Always comply with the local regulations.



WARNING

- Have a Yamaha dealer replace excessively worn tires. Besides being illegal, operating the vehicle with excessively worn tires decreases riding stability and can lead to loss of control.
- The replacement of all wheel and brake-related parts, including the tires, should be left to a Yamaha dealer, who has the necessary professional knowledge and experience to do so.
- Ride at moderate speeds after changing a tire since the tire surface must first be “broken in” for it to develop its optimal characteristics.

Tire information

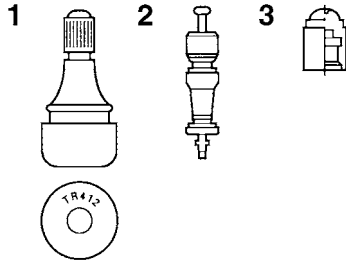

1. Tire air valve
2. Tire air valve core
3. Tire air valve cap with seal

This model is equipped with tubeless tires and tire air valves.

Tires age, even if they have not been used or have only been used occasionally. Cracking of the tread and sidewall rubber, sometimes accompanied by carcass deformation, is an evidence of ageing. Old and aged tires shall be checked by tire specialists to ascertain their suitability for further use.

EWA10902

! WARNING

- The front and rear tires should be of the same make and design, otherwise the handling

characteristics of the motorcycle may be different, which could lead to an accident.

- Always make sure that the valve caps are securely installed to prevent air pressure leakage.
- Use only the tire valves and valve cores listed below to avoid tire deflation during a ride.

After extensive tests, only the tires listed below have been approved for this model by Yamaha.

Front tire:

Size:
120/70ZR17 M/C (58W)
Manufacturer/model:
DUNLOP/D222F

Rear tire:

Size:
180/55ZR17 M/C (73W)
Manufacturer/model:
DUNLOP/D222

FRONT and REAR:

Tire air valve:
TR412
Valve core:
#9100 (original)

! WARNING

This motorcycle is fitted with super-high-speed tires. Note the following points in order to make the most efficient use of these tires.

- Use only the specified replacement tires. Other tires may run the danger of bursting at super high speeds.
- Brand-new tires can have a relatively poor grip on certain road surfaces until they have been “broken in”. Therefore, it is advisable before doing any high-speed riding to ride conservatively for approximately 100 km (60 mi) after installing a new tire.
- The tires must be warmed up before a high-speed run.
- Always adjust the tire air pressure according to the operating conditions.

Periodic maintenance and adjustment

EAU21963

Cast wheels

To maximize the performance, durability, and safe operation of your vehicle, note the following points regarding the specified wheels.

- The wheel rims should be checked for cracks, bends, warpage or other damage before each ride. If any damage is found, have a Yamaha dealer replace the wheel. Do not attempt even the smallest repair to the wheel. A deformed or cracked wheel must be replaced.
- The wheel should be balanced whenever either the tire or wheel has been changed or replaced. An unbalanced wheel can result in poor performance, adverse handling characteristics, and a shortened tire life.

EAU22083

Adjusting the clutch lever free play

Measure the clutch lever free play as shown.

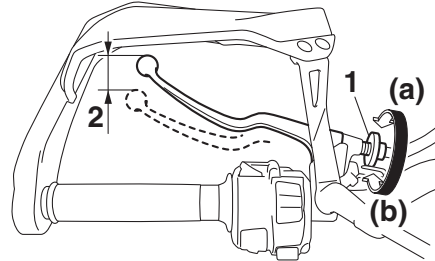

1. Clutch lever free play adjusting bolt
2. Clutch lever free play

Clutch lever free play:
5.0–10.0 mm (0.20–0.39 in)

Periodically check the clutch lever free play and, if necessary, adjust it as follows.

To increase the clutch lever free play, turn the clutch lever free play adjusting bolt in direction (a). To decrease the clutch lever free play, turn the adjusting bolt in direction (b).

TIP

If the specified free play cannot be obtained as described above or if the clutch does not operate correctly, have a Yamaha dealer check the internal clutch mechanism.

Checking the brake lever free play

EAU37914

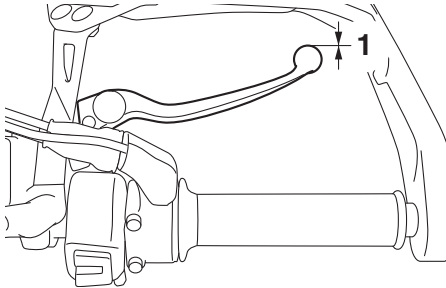

1. No brake lever free play

There should be no free play at the brake lever end. If there is free play, have a Yamaha dealer inspect the brake system.

EWA14212

! WARNING

A soft or spongy feeling in the brake lever can indicate the presence of air in the hydraulic system. If there is air in the hydraulic system, have a Yamaha dealer bleed the system before operating the vehicle. Air in the hydraulic system will diminish the

braking performance, which may result in loss of control and an accident.

Brake light switches

EAU36505

The brake light should come on just before braking takes effect. The brake light is activated by switches connected to the brake lever and brake pedal. Since the brake light switches are components of the anti-lock brake system, they should only be serviced by a Yamaha dealer.

Periodic maintenance and adjustment

Checking the front and rear brake pads

EAU22393

The front and rear brake pads must be checked for wear at the intervals specified in the periodic maintenance and lubrication chart.

Front brake pads

EAU36891

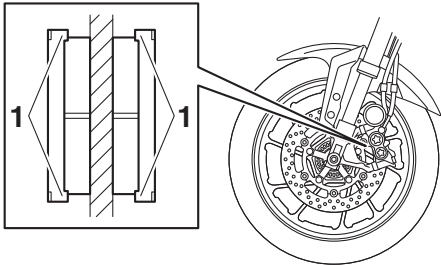

1. Brake pad wear indicator

Each front brake pad is provided with wear indicators, which allows you to check the brake pad wear without having to disassemble the brake. To check the brake pad wear, check the position of the wear indicators while applying the brake. If a brake pad has worn to the point that a wear indicator almost

touches the brake disc, have a Yamaha dealer replace the brake pads as a set.

Rear brake pads

EAU46292

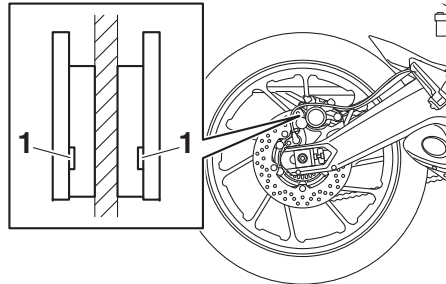

1. Brake pad wear indicator groove

Each rear brake pad is provided with wear indicator grooves, which allow you to check the brake pad wear without having to disassemble the brake. To check the brake pad wear, check the wear indicator grooves. If a brake pad has worn to the point that a wear indicator groove almost appears, have a Yamaha dealer replace the brake pads as a set.

Checking the brake fluid level

EAU40262

Before riding, check that the brake fluid is above the minimum level mark. Check the brake fluid level with the top of the reservoir level. Replenish the brake fluid if necessary.

Front brake

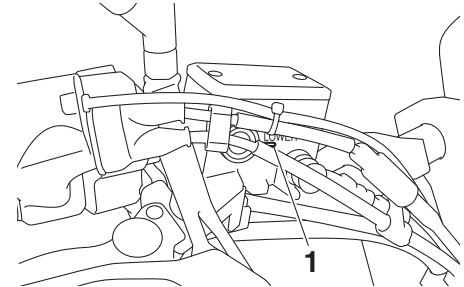

1. Minimum level mark

Periodic maintenance and adjustment

Rear brake

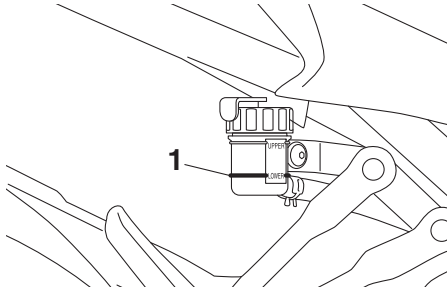

1. Minimum level mark

Specified brake fluid:
DOT 4

EWA16011

WARNING

Improper maintenance can result in loss of braking ability. Observe these precautions:

- Insufficient brake fluid may allow air to enter the brake system, reducing braking performance.
- Clean the filler cap before removing. Use only DOT 4 brake fluid from a sealed container.

- Use only the specified brake fluid; otherwise, the rubber seals may deteriorate, causing leakage.
- Refill with the same type of brake fluid. Adding a brake fluid other than DOT 4 may result in a harmful chemical reaction.
- Be careful that water or dust does not enter the brake fluid reservoir when refilling. Water will significantly lower the boiling point of the fluid and may result in vapor lock, and dirt may clog the ABS hydraulic unit valves.

fluid level goes down suddenly, have a Yamaha dealer check the cause before further riding.

ECA17641

NOTICE

Brake fluid may damage painted surfaces or plastic parts. Always clean up spilled fluid immediately.

As the brake pads wear, it is normal for the brake fluid level to gradually go down. A low brake fluid level may indicate worn brake pads and/or brake system leakage; therefore, be sure to check the brake pads for wear and the brake system for leakage. If the brake

Periodic maintenance and adjustment

Changing the brake fluid

EAU22734

Have a Yamaha dealer change the brake fluid every 2 years. In addition, have the seals of the master cylinders and brake calipers, as well as the brake hoses replaced at the intervals listed below or sooner if they are damaged or leaking.

- Brake seals: every 2 years
- Brake hoses: every 4 years

Drive chain slack

EAU22762

The drive chain slack should be checked before each ride and adjusted if necessary.

To check the drive chain slack

EAU73530

1. Place the motorcycle on the centerstand.
2. Shift the transmission into the neutral position.
3. Measure the drive chain slack as shown.

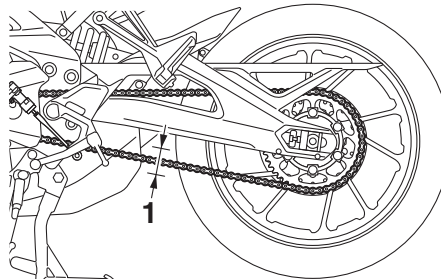

1. Drive chain slack

Drive chain slack:

35.0–45.0 mm (1.38–1.77 in)

4. If the drive chain slack is incorrect, adjust it as follows. **NOTICE: Improper drive chain slack will overload the engine as well as other vital parts of the motorcycle and can lead to chain slippage or breakage. If the drive chain slack is more than 50.0 mm (1.97 in), the chain can damage the frame, swingarm, and other parts. To prevent this from occurring, keep the drive chain slack within the specified limits.**

[ECA17791]

To adjust the drive chain slack

EAU63122

Consult a Yamaha dealer before adjusting the drive chain slack.

1. Take the motorcycle off the centerstand, and then put the side-stand down.
2. Loosen the axle nut and the lock-nut on each side of the swingarm.

Periodic maintenance and adjustment

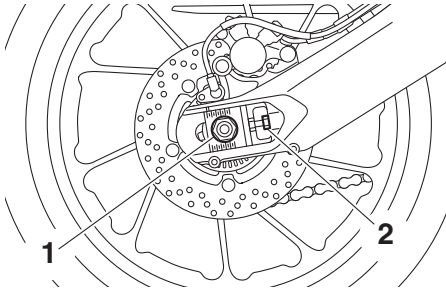

1. Axle nut
2. Locknut

3. Place the motorcycle on the centerstand.
4. To tighten the drive chain, turn the drive chain slack adjusting bolt on each side of the swingarm in direction (a). To loosen the drive chain, turn the adjusting bolt on each side of the swingarm in direction (b), and then push the rear wheel forward.

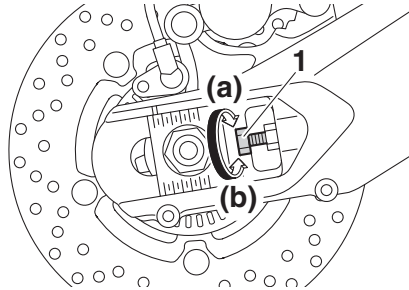

1. Drive chain slack adjusting bolt

TIP

Using the alignment marks on the drive chain pullers and the notch on each side of the swingarm, make sure that both drive chain pullers are in the same position for proper wheel alignment.

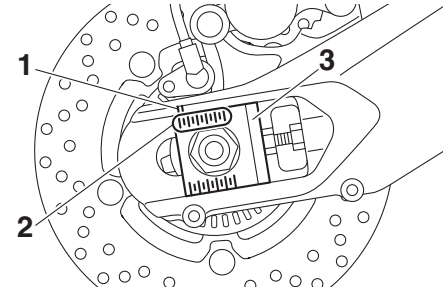

1. Notch
2. Alignment mark
3. Drive chain puller

5. Take the motorcycle off the centerstand, and then put the side-stand down.
6. Tighten the axle nut, then the locknuts to their specified torques.

Tightening torques:

Axle nut:

150 N·m (15 kgf·m, 111 lb·ft)

Locknut:

16 N·m (1.6 kgf·m, 12 lb·ft)

7. Make sure that the drive chain pullers are in the same position, the drive chain slack is correct, and the drive chain moves smoothly.

Periodic maintenance and adjustment

Cleaning and lubricating the drive chain

EAU23026

The drive chain must be cleaned and lubricated at the intervals specified in the periodic maintenance and lubrication chart, otherwise it will quickly wear out, especially when riding in dusty or wet areas. Service the drive chain as follows.

ECA10584

NOTICE

The drive chain must be lubricated after washing the motorcycle, riding in the rain or riding in wet areas.

1. Clean the drive chain with kerosene and a small soft brush.
NOTICE: To prevent damaging the O-rings, do not clean the drive chain with steam cleaners, high-pressure washers or inappropriate solvents. [ECA11122]
2. Wipe the drive chain dry.
3. Thoroughly lubricate the drive chain with a special O-ring chain lubricant. **NOTICE: Do not use engine oil or any other lubricants for the drive chain, as they**

may contain substances that could damage the O-rings.

[ECA11112]

Checking and lubricating the cables

EAU23098

The operation of all control cables and the condition of the cables should be checked before each ride, and the cables and cable ends should be lubricated if necessary. If a cable is damaged or does not move smoothly, have a Yamaha dealer check or replace it. **WARNING! Damage to the outer housing of cables may result in internal rusting and cause interference with cable movement. Replace damaged cables as soon as possible to prevent unsafe conditions.** [EWA10712]

Recommended lubricant:

Yamaha cable lubricant or other suitable cable lubricant

Checking and lubricating the throttle grip and cable

EAU23115

The operation of the throttle grip should be checked before each ride. In addition, the cable should be lubricated by a Yamaha dealer at the intervals specified in the periodic maintenance chart.

The throttle cable is equipped with a rubber cover. Make sure that the cover is securely installed. Even though the cover is installed correctly, it does not completely protect the cable from water entry. Therefore, use care not to pour water directly onto the cover or cable when washing the vehicle. If the cable or cover becomes dirty, wipe clean with a moist cloth.

Checking and lubricating the brake and shift pedals

EAU44276

The operation of the brake and shift pedals should be checked before each ride, and the pedal pivots should be lubricated if necessary.

Recommended lubricant:
Lithium-soap-based grease

Brake pedal

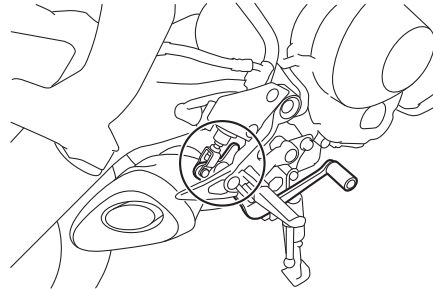

Shift pedal

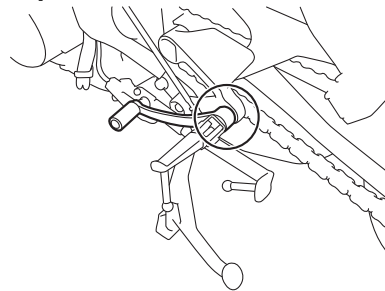

Periodic maintenance and adjustment

Checking and lubricating the brake and clutch levers

EAU23144

The operation of the brake and clutch levers should be checked before each ride, and the lever pivots should be lubricated if necessary.

Brake lever

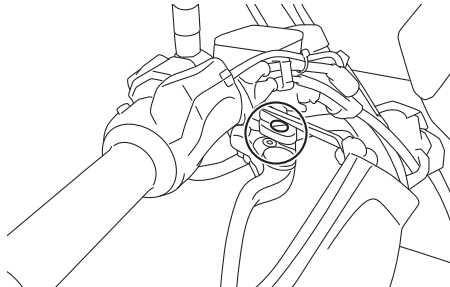

Clutch lever

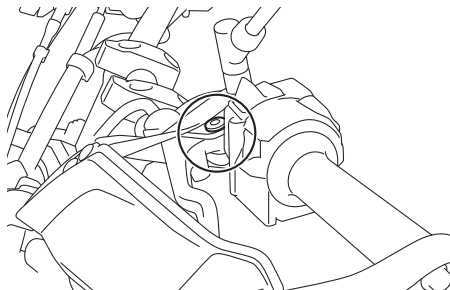

Recommended lubricants:

Brake lever:

Silicone grease

Clutch lever:

Lithium-soap-based grease

Checking and lubricating the centerstand and sidestand

EAU23215

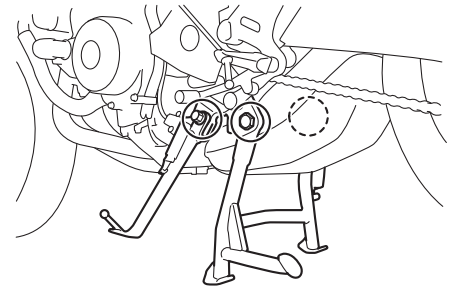

The operation of the centerstand and sidestand should be checked before each ride, and the pivots and metal-to-metal contact surfaces should be lubricated if necessary.

EWA10742

! WARNING

If the centerstand or sidestand does not move up and down smoothly, have a Yamaha dealer check or repair it. Otherwise, the centerstand or sidestand could contact the ground and distract the operator, resulting in a possible loss of control.

Recommended lubricant:
Lithium-soap-based grease

Lubricating the swingarm pivots

EAUM1653

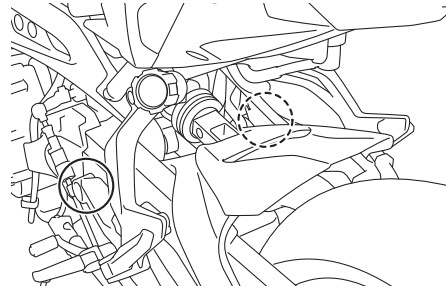

The swingarm pivots must be lubricated by a Yamaha dealer at the intervals specified in the periodic maintenance and lubrication chart.

Recommended lubricant:
Lithium-soap-based grease

Checking the front fork

EAU23273

The condition and operation of the front fork must be checked as follows at the intervals specified in the periodic maintenance and lubrication chart.

To check the condition

Check the inner tubes for scratches, damage and excessive oil leakage.

To check the operation

1. Place the vehicle on a level surface and hold it in an upright position. **WARNING! To avoid injury, securely support the vehicle so there is no danger of it falling over.** ^[EWA10752]
2. While applying the front brake, push down hard on the handlebars several times to check if the front fork compresses and rebounds smoothly.

Periodic maintenance and adjustment

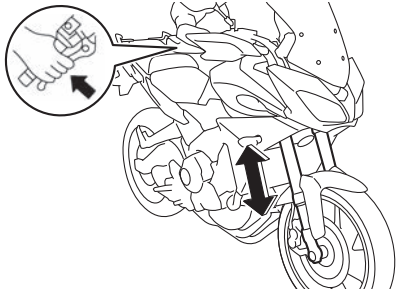

ECA10591

NOTICE

6

If any damage is found or the front fork does not operate smoothly, have a Yamaha dealer check or repair it.

EAU45512

Checking the steering

Worn or loose steering bearings may cause danger. Therefore, the operation of the steering must be checked as follows at the intervals specified in the periodic maintenance and lubrication chart.

1. Place the vehicle on the center-stand. **WARNING! To avoid injury, securely support the vehicle so there is no danger of it falling over.** [EWA10752]
2. Hold the lower ends of the front fork legs and try to move them forward and backward. If any free play can be felt, have a Yamaha dealer check or repair the steering.

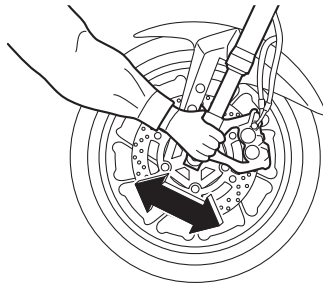

EAU23292

Checking the wheel bearings

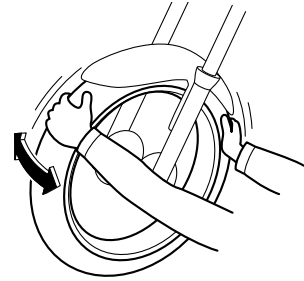

The front and rear wheel bearings must be checked at the intervals specified in the periodic maintenance and lubrication chart. If there is play in the wheel hub or if the wheel does not turn smoothly, have a Yamaha dealer check the wheel bearings.

Periodic maintenance and adjustment

Battery

EAU50212

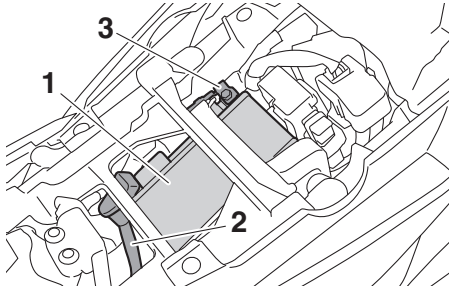

1. Battery
2. Positive battery lead (red)
3. Negative battery lead (black)

The battery is located under the rider seat. (See page 3-34.)

This model is equipped with a VRLA (Valve Regulated Lead Acid) battery. There is no need to check the electrolyte or to add distilled water. However, the battery lead connections need to be checked and, if necessary, tightened.

EWA10761

WARNING

- **Electrolyte is poisonous and dangerous since it contains sulfuric acid, which causes severe**

burns. Avoid any contact with skin, eyes or clothing and always shield your eyes when working near batteries. In case of contact, administer the following **FIRST AID**.

- **EXTERNAL:** Flush with plenty of water.
- **INTERNAL:** Drink large quantities of water or milk and immediately call a physician.
- **EYES:** Flush with water for 15 minutes and seek prompt medical attention.
- **Batteries produce explosive hydrogen gas. Therefore, keep sparks, flames, cigarettes, etc., away from the battery and provide sufficient ventilation when charging it in an enclosed space.**
- **KEEP THIS AND ALL BATTERIES OUT OF THE REACH OF CHILDREN.**

To charge the battery

Have a Yamaha dealer charge the battery as soon as possible if it seems to have discharged. Keep in mind that the

battery tends to discharge more quickly if the vehicle is equipped with optional electrical accessories.

ECA16522

NOTICE

To charge a VRLA (Valve Regulated Lead Acid) battery, a special (constant-voltage) battery charger is required. Using a conventional battery charger will damage the battery.

To store the battery

1. If the vehicle will not be used for more than one month, remove the battery, fully charge it, and then place it in a cool, dry place. **NOTICE: When removing the battery, be sure to turn the main switch off, then disconnect the negative lead before disconnecting the positive lead.** [ECA16304]
2. If the battery will be stored for more than two months, check it at least once a month and fully charge it if necessary.
3. Fully charge the battery before installation. **NOTICE: When installing the battery, be sure to turn the main switch off, then**

Periodic maintenance and adjustment

connect the positive lead before connecting the negative lead.

[ECA16842]

4. After installation, make sure that the battery leads are properly connected to the battery terminals.

ECA16531

NOTICE

Always keep the battery charged. Storing a discharged battery can cause permanent battery damage.

Replacing the fuses

EAU63134

The fuse boxes and individual fuses are located under the rider seat (see page 3-34) and behind panel A (see page 6-9).

To access fuse box 1, the main fuse, and the fuel injection system fuse, remove the rider seat. (See page 3-34.)

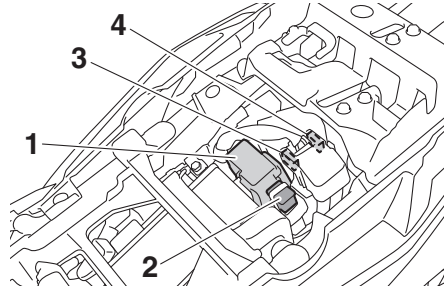

1. Fuse box 1
2. Main fuse
3. Fuel injection system fuse
4. Fuel injection system spare fuse

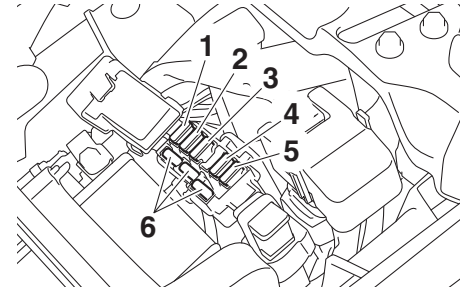

1. Radiator fan motor fuse
2. Backup fuse (for clock and immobilizer system)
3. Electronic throttle valve fuse
4. ABS solenoid fuse
5. ABS motor fuse
6. Spare fuse

TIP

To access the fuel injection system fuse, remove the starter relay cover by pulling it upward.

Periodic maintenance and adjustment

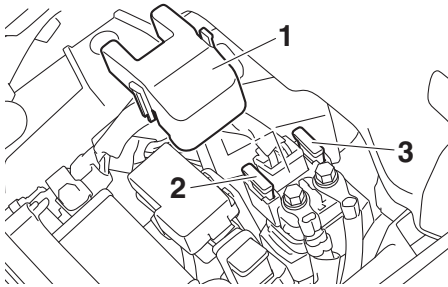

1. Starter relay cover
2. Fuel injection system fuse
3. Fuel injection system spare fuse

To access fuse box 2 and fuse box 3, remove panel A. (See page 6-9.)

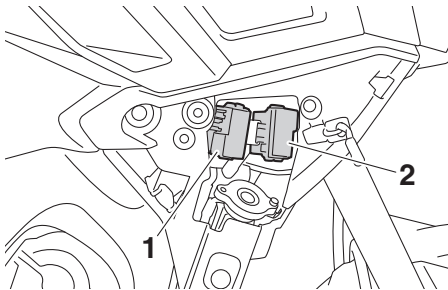

1. Fuse box 2
2. Fuse box 3

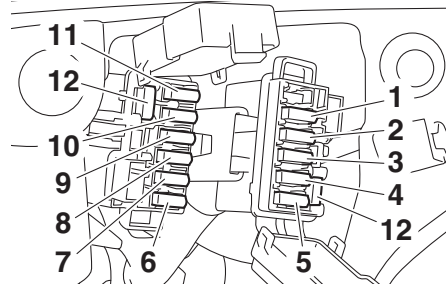

1. Parking lighting fuse
2. Headlight fuse
3. Plug +12V fuse (DC connector, option)
4. Plug +12V fuse (DC jack)
5. Cruise control fuse
6. Brake light fuse
7. Signaling system fuse
8. Fog lamp fuse (option)
9. ABS control unit fuse
10. Seat heater fuse (option)
11. Ignition fuse
12. Spare fuse

If a fuse is blown, replace it as follows.

1. Turn the key to "OFF" and turn off the electrical circuit in question.
2. Remove the blown fuse, and then install a new fuse of the specified amperage. **WARNING! Do not use a fuse of a higher amperage rating than recommended to**

avoid causing extensive damage to the electrical system and possibly a fire. [EWA15132]

Specified fuses:

- Main fuse:
50.0 A
- Fuel injection system fuse:
20.0 A

Specified fuses (fuse box 1):

- Radiator fan motor fuse:
15.0 A
- ABS motor fuse:
30.0 A
- ABS solenoid fuse:
15.0 A
- Backup fuse:
7.5 A
- Electronic throttle valve fuse:
7.5 A

Periodic maintenance and adjustment

6

Specified fuses (fuse box 2):

- Fog lamp fuse:
2.0 A
- Brake light fuse:
1.0 A
- Signaling system fuse:
7.5 A
- Ignition fuse:
15.0 A
- ABS control unit fuse:
7.5 A
- Seat heater fuse:
7.5 A

Specified fuses (fuse box 3):

- Headlight fuse:
7.5 A
- Parking lighting fuse:
7.5 A
- Cruise control fuse:
1.0 A
- Plug +12V fuse:
2.0 A
- Plug +12V fuse:
2.0 A

3. Turn the key to "ON" and turn on the electrical circuit in question to check if the device operates.
4. If the fuse immediately blows again, have a Yamaha dealer check the electrical system.

Vehicle lights

EAUJ2261

This model is equipped with LED lights for headlights, auxiliary lights and brake/tail light. If a light does not come on, check the fuse and then have a Yamaha dealer check the vehicle.

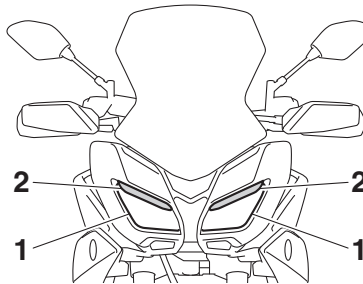

1. Headlight
2. Auxiliary light

NOTICE

Do not affix any type of tinted film or stickers to the headlight lens.

ECA16581

Replacing a turn signal light bulb

EAU24205

1. Remove the turn signal light lens by removing the screw.

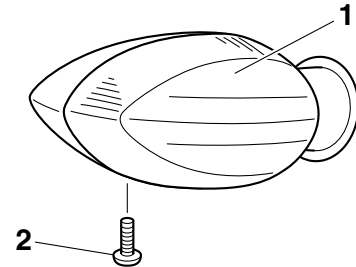

1. Turn signal light lens
2. Screw

2. Remove the burnt-out bulb by pushing it in and turning it counterclockwise.

EAU58010

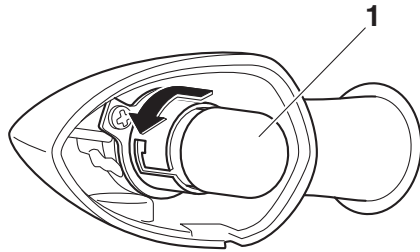

1. Turn signal light bulb
3. Insert a new bulb into the socket, push it in, and then turn it clockwise until it stops.
4. Install the lens by installing the screw. **NOTICE: Do not over-tighten the screw, otherwise the lens may break.** [ECA11192]

Replacing the license plate light bulb

1. Remove the license plate light unit by removing the nuts and collars, and then remove the license plate light bulb socket (together with the bulb) by pulling it out.

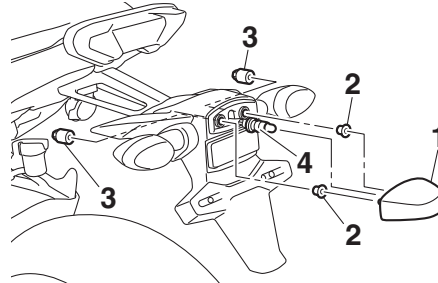

1. License plate light unit
2. Collar
3. Nut
4. License plate light bulb socket

2. Remove the burnt-out bulb by pulling it out.

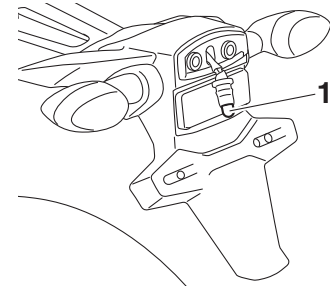

1. License plate light bulb
3. Insert a new bulb into the socket.
4. Install the socket (together with the bulb) by pushing it in, and then install the license plate light unit by installing the collars and nuts.

Periodic maintenance and adjustment

EAU25872

Troubleshooting

Although Yamaha motorcycles receive a thorough inspection before shipment from the factory, trouble may occur during operation. Any problem in the fuel, compression, or ignition systems, for example, can cause poor starting and loss of power.

The following troubleshooting charts represent quick and easy procedures for checking these vital systems yourself. However, should your motorcycle require any repair, take it to a Yamaha dealer, whose skilled technicians have the necessary tools, experience, and know-how to service the motorcycle properly.

Use only genuine Yamaha replacement parts. Imitation parts may look like Yamaha parts, but they are often inferior, have a shorter service life and can lead to expensive repair bills.

EWA15142

WARNING

When checking the fuel system, do not smoke, and make sure there are no open flames or sparks in the area, including pilot lights from water

heaters or furnaces. Gasoline or gasoline vapors can ignite or explode, causing severe injury or property damage.

Troubleshooting charts

Starting problems or poor engine performance

1. Fuel

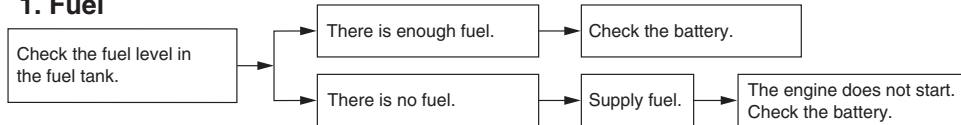

2. Battery

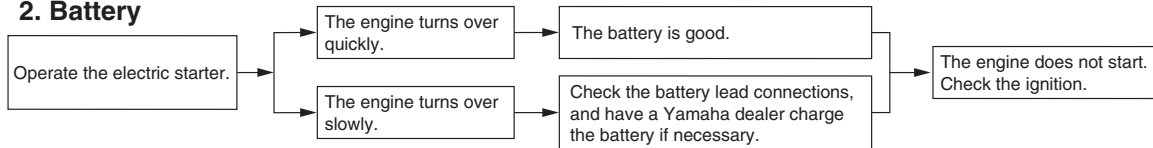

3. Ignition

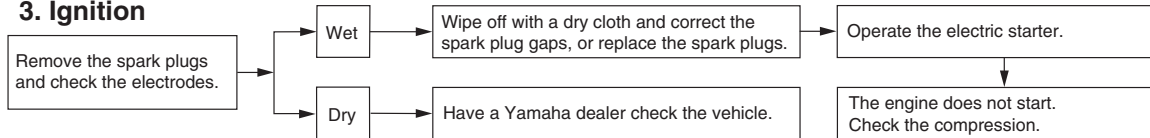

4. Compression

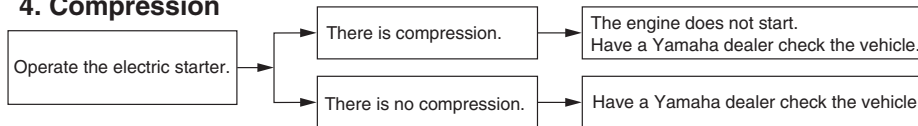

Periodic maintenance and adjustment

Engine overheating

EWA10401

⚠ WARNING

- Do not remove the radiator cap when the engine and radiator are hot. Scalding hot fluid and steam may be blown out under pressure, which could cause serious injury. Be sure to wait until the engine has cooled.
- After removing the radiator cap retaining bolt, place a thick rag, like a towel, over the radiator cap, and then slowly rotate the cap counterclockwise to the detent to allow any residual pressure to escape. When the hissing sound has stopped, press down on the cap while turning it counterclockwise, and then remove the cap.

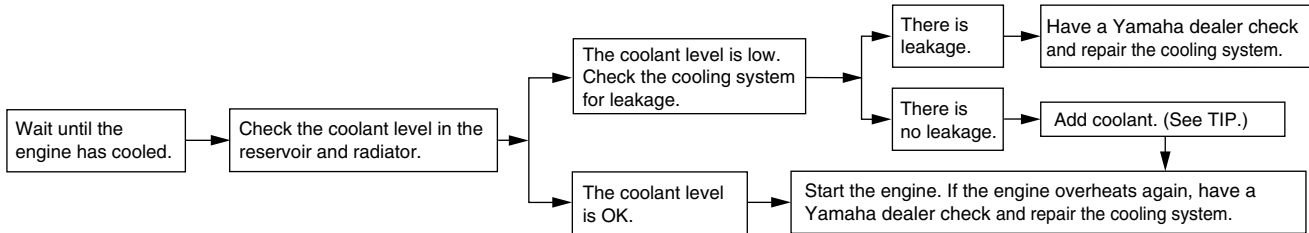

TIP

If coolant is not available, tap water can be temporarily used instead, provided that it is changed to the recommended coolant as soon as possible.

Matte color caution

EAU37834

ECA15193

NOTICE

Some models are equipped with matte colored finished parts. Be sure to consult a Yamaha dealer for advice on what products to use before cleaning the vehicle. Using a brush, harsh chemical products or cleaning compounds when cleaning these parts will scratch or damage their surface. Wax also should not be applied to any matte colored finished parts.

Care

EAU83443

Frequent, thorough cleaning of the vehicle will not only enhance its appearance but also will improve its general performance and extend the useful life of many components. Washing, cleaning, and polishing will also give you a chance to inspect the condition of the vehicle more frequently. Be sure to wash the vehicle after riding in the rain or near the sea, because salt is corrosive to metals.

TIP

- The roads of heavy snowfall areas may be sprayed with salt as a de-icing method. This salt can stay on the roads well into spring, so be sure to wash the underside and chassis parts after riding in such areas.
- Genuine Yamaha care and maintenance products are sold under the YAMALUBE brand in many markets worldwide.
- See your Yamaha dealer for additional cleaning tips.

ECA26280

NOTICE

Improper cleaning can cause cosmetic and mechanical damage. Do not use:

- high-pressure washers or steam-jet cleaners. Excessive water pressure may cause water seepage and deterioration of wheel bearings, brakes, transmission seals and electrical devices. Avoid high-pressure detergent applications such as those available in coin-operated car washers.
- harsh chemicals, including strong acidic wheel cleaners, especially on spoke or magnesium wheels.
- harsh chemicals, abrasive cleaning compounds, or wax on matte-finished parts. Brushes can scratch and damage the matte-finish, use soft sponge or towel only.
- towels, sponges, or brushes contaminated with abrasive cleaning products or strong

Motorcycle care and storage

chemicals such as, solvents, gasoline, rust removers, brake fluid, or antifreeze, etc.

Before washing

1. Park the vehicle out of direct sunlight and allow it to cool. This will help avoid water spots.
2. Make sure all caps, covers, electrical couplers and connectors are tightly installed.
3. Cover the muffler end with a plastic bag and a strong rubber band.
4. Pre-soak stubborn stains like insects or bird droppings with a wet towel for a few minutes.
5. Remove road grime and oil stains with a quality degreasing agent and a plastic-bristle brush or sponge. **NOTICE: Do not use degreasing agent on areas requiring lubrication such as seals, gaskets, and wheel axles. Follow product instructions.**

[ECA26290]

Washing

1. Rinse off any degreaser and spray down the vehicle with a garden hose. Use only enough pressure to do the job. Avoid spraying water directly into the muffler, instrument panel, air inlet, or other inner areas such as underseat storage compartments.
2. Wash the vehicle with a quality automotive-type detergent mixed with cool water and a soft, clean towel or sponge. Use an old toothbrush or plastic-bristle brush for hard-to-reach places. **NOTICE: Use cold water if the vehicle has been exposed to salt. Warm water will increase salt's corrosive properties.** [ECA26301]
3. For windshield-equipped vehicles: Clean the windshield with a soft towel or sponge dampened with water and a pH neutral detergent. If necessary, use a high-quality windshield cleaner or polish for motorcycles. **NOTICE: Never use any strong chemicals to clean the windshield. Additionally, some cleaning compounds for**

plastic may scratch the windshield, so be sure to test all cleaning products before general application. [ECA26310]

4. Rinse off thoroughly with clean water. Be sure to remove all detergent residues, as they can be harmful to plastic parts.

After washing

1. Dry the vehicle with a chamois or absorbent towel, preferably microfiber terrycloth.
2. For drive chain-equipped models: Dry and then lubricate the drive chain to prevent rust.
3. Use a chrome polish to shine chrome, aluminum, and stainless steel parts. Often the thermally induced discoloring of stainless steel exhaust systems can be removed through polishing.
4. Apply a corrosion protection spray on all metal parts including chrome or nickel-plated surfaces. **WARNING! Do not apply silicone or oil spray to seats, hand grips, rubber foot pegs or tire treads. Otherwise these parts**

will become slippery, which could cause loss of control. Thoroughly clean the surfaces of these parts before operating the vehicle. [EWA20650]

5. Treat rubber, vinyl, and unpainted plastic parts with a suitable care product.
6. Touch up minor paint damage caused by stones, etc.
7. Wax all painted surfaces using a non-abrasive wax or use a detail spray for motorcycles.
8. When finished cleaning, start the engine and let it idle for several minutes to help dry any remaining moisture.
9. If the headlight lens has fogged up, start the engine and turn on the headlight to help remove the moisture.
10. Let the vehicle dry completely before storing or covering it.

ECA26320

NOTICE

- Do not apply wax to rubber or unpainted plastic parts.

- Do not use abrasive polishing compounds as they will wear away the paint.
- Apply sprays and wax sparingly. Wipe off excess afterwards.

EWA20660

⚠ WARNING

Contaminants left on the brakes or tires can cause loss of control.

- Make sure there is no lubricant or wax on the brakes or tires.
- If necessary, wash the tires with warm water and a mild detergent.
- If necessary, clean the brake discs and pads with brake cleaner or acetone.
- Before riding at higher speeds, test the vehicle's braking performance and cornering behavior.

Storage

Always store the vehicle in a cool, dry place. If necessary, protect it against dust with a porous cover. Be sure the engine and the exhaust system are cool before covering the vehicle. If the vehicle often sits for weeks at a time between uses, the use of a quality fuel stabilizer is recommended after each fill-up.

ECA21170

NOTICE

- Storing the vehicle in a poorly ventilated room or covering it with a tarp, while it is still wet, will allow water and humidity to seep in and cause rust.
- To prevent corrosion, avoid damp cellars, stables (because of the presence of ammonia) and areas where strong chemicals are stored.

Long term storage

Before storing the vehicle long term (60 days or more):

Motorcycle care and storage

7

1. Make all necessary repairs and perform any outstanding maintenance.
2. Follow all instructions in the Care section of this chapter.
3. Fill up the fuel tank, adding fuel stabilizer according to product instructions. Run the engine for 5 minutes to distribute treated fuel through the fuel system.
4. For vehicles equipped with a fuel cock: Turn the fuel cock lever to the off position.
5. For vehicles with a carburetor: To prevent fuel deposits from building up, drain the fuel in the carburetor float chamber into a clean container. Retighten the drain bolt and pour the fuel back into the fuel tank.
6. Use a quality engine fogging oil according to product instructions to protect internal engine components from corrosion. If engine fogging oil is not available, perform the following steps for each cylinder:
 - a. Remove the spark plug cap and spark plug.
 - b. Pour a teaspoonful of engine oil into the spark plug bore.
 - c. Install the spark plug cap onto the spark plug, and then place the spark plug on the cylinder head so that the electrodes are grounded. (This will limit sparking during the next step.)
 - d. Turn the engine over several times with the starter. (This will coat the cylinder wall with oil.)
WARNING! To prevent damage or injury from sparking, make sure to ground the spark plug electrodes while turning the engine over.
[EWA10952]
 - e. Remove the spark plug cap from the spark plug, and then install the spark plug and the spark plug cap.
7. Lubricate all control cables, pivots, levers and pedals, as well as the sidestand and centerstand (if equipped).
8. Check and correct the tire air pressure, and then lift the vehicle so that all wheels are off the ground. Otherwise, turn the

wheels a little once a month in order to prevent the tires from becoming degraded in one spot.

9. Cover the muffler outlet with a plastic bag to prevent moisture from entering it.
10. Remove the battery and fully charge it, or attach a maintenance charger to keep the battery optimally charged. **NOTICE: Confirm that the battery and its charger are compatible. Do not charge a VRLA battery with a conventional charger.**[ECA26330]

TIP

- If the battery will be removed, charge it once a month and store it in a temperate location between 0-30 °C (32-90 °F).
 - See page 6-30 for more information on charging and storing the battery.
-

Dimensions:

- Overall length:
2160 mm (85.0 in)
- Overall width:
850 mm (33.5 in)
- Overall height:
1375/1430 mm (54.1/56.3 in)
- Seat height:
850/865 mm (33.5/34.1 in)
- Wheelbase:
1500 mm (59.1 in)
- Ground clearance:
135 mm (5.31 in)
- Minimum turning radius:
3.0 m (9.84 ft)

Weight:

- Curb weight:
215 kg (474 lb)

Engine:

- Combustion cycle:
4-stroke
- Cooling system:
Liquid cooled
- Valve train:
DOHC
- Cylinder arrangement:
Inline
- Number of cylinders:
3-cylinder
- Displacement:
847 cm³
- Bore × stroke:
78.0 × 59.1 mm (3.07 × 2.33 in)

- Starting system:
Electric starter

Engine oil:

- Recommended brand:



- SAE viscosity grades:
10W-40
- Recommended engine oil grade:
API service SG type or higher, JASO
standard MA
- Engine oil quantity:
Oil change:
2.40 L (2.54 US qt, 2.11 Imp.qt)
- With oil filter removal:
2.70 L (2.85 US qt, 2.38 Imp.qt)

Coolant quantity:

- Coolant reservoir (up to the maximum level
mark):
0.25 L (0.26 US qt, 0.22 Imp.qt)
- Radiator (including all routes):
1.93 L (2.04 US qt, 1.70 Imp.qt)

Fuel:

- Recommended fuel:
Premium unleaded gasoline (Gasohol [E10]
acceptable)
- Fuel tank capacity:
18 L (4.8 US gal, 4.0 Imp.gal)
- Fuel reserve amount:
2.6 L (0.69 US gal, 0.57 Imp.gal)

Fuel injection:

- Throttle body:
ID mark:
B1J1 00

Drivetrain:

- Gear ratio:
1st:
2.667 (40/15)
- 2nd:
2.000 (38/19)
- 3rd:
1.619 (34/21)
- 4th:
1.381 (29/21)
- 5th:
1.190 (25/21)
- 6th:
1.037 (28/27)

Front tire:

- Type:
Tubeless
- Size:
120/70ZR17 M/C (58W)
- Manufacturer/model:
DUNLOP/D222F

Rear tire:

- Type:
Tubeless
- Size:
180/55ZR17 M/C (73W)
- Manufacturer/model:
DUNLOP/D222

Specifications

Loading:

Maximum load:

179 kg (395 lb)

(Total weight of rider, passenger, cargo
and accessories)

Auxiliary light:

LED

License plate light:

5.0 W

Front brake:

Type:

Hydraulic dual disc brake

Rear brake:

Type:

Hydraulic single disc brake

Front suspension:

Type:

Telescopic fork

Rear suspension:

Type:

Swingarm (link suspension)

Electrical system:

System voltage:

12 V

8

Battery:

Model:

YTZ10S

Voltage, capacity:

12 V, 8.6 Ah (10 HR)

Bulb wattage:

Headlight:

LED

Brake/tail light:

LED

Front turn signal light:

10.0 W

Rear turn signal light:

10.0 W

Identification numbers

EAU53562

Record the vehicle identification number, engine serial number, and the model label information in the spaces provided below. These identification numbers are needed when registering the vehicle with the authorities in your area and when ordering spare parts from a Yamaha dealer.

VEHICLE IDENTIFICATION NUMBER:

ENGINE SERIAL NUMBER:

MODEL LABEL INFORMATION:

Vehicle identification number

EAU26401

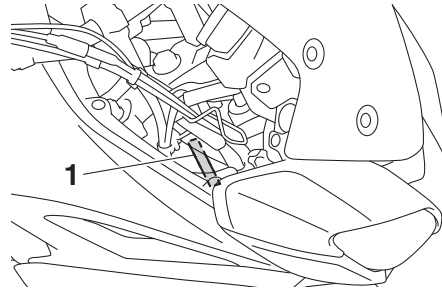

1. Vehicle identification number

The vehicle identification number is stamped into the steering head pipe. Record this number in the space provided.

TIP

The vehicle identification number is used to identify your motorcycle and may be used to register your motorcycle with the licensing authority in your area.

Engine serial number

EAU26442

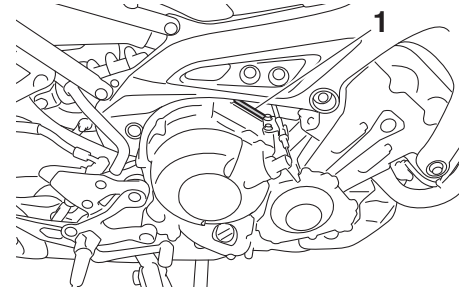

1. Engine serial number

The engine serial number is stamped into the crankcase.

Model label

EAU26461

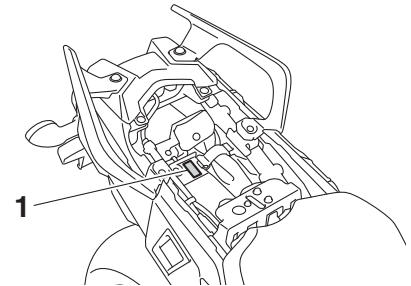

1. Model label

Consumer information

The model label is affixed to the location shown. Record the information on this label in the space provided. This information will be needed when ordering spare parts from a Yamaha dealer.

Diagnostic connector

EAU69910

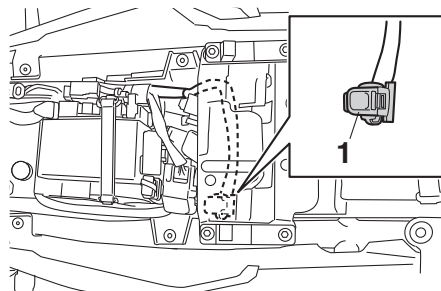

1. Diagnostic connector

The diagnostic connector is located as shown.

Vehicle data recording

EAU85300

This model's ECU stores certain vehicle data to assist in the diagnosis of malfunctions and for research, statistical analysis and development purposes.

Although the sensors and recorded data will vary by model, the main data points are:

- Vehicle status and engine performance data
- Fuel-injection and emission-related data

This data will be uploaded only when a special Yamaha diagnostic tool is attached to the vehicle, such as when maintenance checks or service procedures are performed.

Vehicle data uploaded will be handled appropriately according to the following Privacy Policy.

Privacy Policy

<https://www.yamaha-motor.eu/eu/privacy/privacy-policy.aspx>

Yamaha will not disclose this data to a third party except in the following cases. In addition, Yamaha may provide vehicle data to a contractor in order to outsource services related to the handling of vehicle data. Even in this case, Yamaha will require the contractor to properly handle the vehicle data we provided and Yamaha will appropriately manage the data.

- With the consent of the vehicle owner
- Where obligated by law
- For use by Yamaha in litigation
- When the data is not related to an individual vehicle nor owner

Index

A

- ABS3-27
- ABS warning light3-6
- Air filter element6-15
- Auxiliary DC connector3-44
- Auxiliary DC jack3-43

B

- Battery6-30
- Brake and clutch levers, checking and lubricating6-27
- Brake and shift pedals, checking and lubricating6-26
- Brake fluid, changing6-23
- Brake fluid level, checking6-21
- Brake lever3-26
- Brake lever free play, checking6-20
- Brake light switches6-20
- Brake pedal3-27

C

- Cables, checking and lubricating6-25
- Canister6-11
- Care7-1
- Catalytic converter3-33
- Centerstand and sidestand, checking and lubricating6-27
- Clutch lever3-25
- Clutch lever free play, adjusting6-19
- Coolant6-14
- Cruise control indicator lights3-6
- Cruise control switches3-4
- Cruise control system3-8

D

- Data recording, vehicle9-2
- Diagnostic connector9-2

- Dimmer/Pass switch3-4
- Display, main screen3-11
- Display, menu screen3-15
- D-mode (drive mode)3-25
- Drive chain, cleaning and lubricating ... 6-25
- Drive chain slack6-23
- Drive mode switch3-4

E

- Engine break-in5-4
- Engine idling speed, checking6-15
- Engine oil6-11
- Engine oil and Coolant warning light3-7
- Engine serial number9-1
- Engine trouble warning light3-6

F

- Front and rear brake pads, checking ... 6-21
- Front fork, adjusting3-39
- Front fork, checking6-28
- Fuel3-31
- Fuel consumption, tips for reducing5-4
- Fuel tank cap3-30
- Fuel tank overflow hose3-33
- Fuses, replacing6-31

H

- Handlebar position, adjusting3-39
- Handlebar switches3-3
- Hazard switch3-4
- Headlight beams, adjusting3-38
- Helmet holder3-37
- High beam indicator light3-6
- Horn switch3-4

I

- Identification numbers9-1
- Ignition circuit cut-off system3-45

- Immobilizer system3-1
- Immobilizer system indicator light3-7
- Indicator lights and warning lights3-5

L

- License plate light bulb, replacing6-34

M

- Main switch/steering lock3-2
- Maintenance and lubrication, periodic6-5
- Maintenance, emission control system6-3
- Matte color, caution7-1
- Model label9-1

N

- Neutral indicator light3-6

P

- Panel, removing and installing6-9
- Parking5-5
- Part locations2-1

Q

- Quick shift system3-26

R

- Rider seat height, adjusting3-35

S

- Safety information1-1
- Seats3-34
- Shift indicator light3-7
- Shifting5-2
- Shift pedal3-26
- Shock absorber assembly, adjusting3-41
- Sidestand3-44
- Spark plugs, checking6-10
- Specifications8-1
- Starting the engine5-1
- Steering, checking6-29

Stop/Run/Start switch	3-4
Storage	7-3
Storage compartment	3-38
Swingarm pivots, lubricating	6-28

T

TCS switch	3-4
Throttle grip and cable, checking and lubricating.....	6-26
Throttle grip free play, checking.....	6-16
Tires.....	6-16
Tool kit.....	6-2
Traction control system.....	3-28
Traction control system indicator light ...	3-6
Troubleshooting.....	6-35
Troubleshooting charts.....	6-36
Turn signal indicator lights	3-5
Turn signal light bulb, replacing	6-33
Turn signal switch.....	3-4

V

Valve clearance	6-16
Vehicle identification number	9-1
Vehicle lights	6-33

W

Wheel bearings, checking	6-29
Wheels.....	6-19
Windshield	3-38

Y

Yamalube.....	6-13
---------------	------

