



YAMAHA



F30B F40F

OWNER'S MANUAL

▲ Read this manual carefully before operating this outboard motor.

6BG-28199-79-E0

Read this manual carefully before operating this outboard motor. Keep this manual onboard in a waterproof bag when boating. This manual should stay with the outboard motor if it is sold.

Important manual information

EMU25108

To the owner

Thank you for selecting a Yamaha outboard motor. This Owner's Manual contains information needed for proper operation, maintenance and care. A thorough understanding of these simple instructions will help you obtain maximum enjoyment from your new Yamaha. If you have any question about the operation or maintenance of your outboard motor, please consult a Yamaha dealer.

In this Owner's Manual particularly important information is distinguished in the following ways.

 : This is the safety alert symbol. It is used to alert you to potential personal injury hazards. Obey all safety messages that follow this symbol to avoid possible injury or death.

EWMO0782

WARNING

A WARNING indicates a hazardous situation which, if not avoided, could result in death or serious injury.

ECM00702

NOTICE

A NOTICE indicates special precautions that must be taken to avoid damage to the outboard motor or other property.

TIP:

A TIP provides key information to make procedures easier or clearer.

Yamaha continually seeks advancements in product design and quality. Therefore, while this manual contains the most current product information available at the time of printing, there may be minor discrepancies between your machine and this manual. If

there is any question concerning this manual, please consult your Yamaha dealer.

To ensure long product life, Yamaha recommends that you use the product and perform the specified periodic inspections and maintenance by correctly following the instructions in the owner's manual. Any damage resulting from neglect of these instructions is not covered by warranty.

Some countries have laws or regulations restricting users from taking the product out of the country where it was purchased, and it may be impossible to register the product in the destination country. Additionally, the warranty may not apply in certain regions. When planning to take the product to another country, consult the dealer where the product was purchased for further information.

If the product was purchased used, please consult your closest dealer for customer re-registration, and to be eligible for the specified services.

TIP:

The F30BEHD, F30BET, F40FED, F40FEHD, F40FET and the standard accessories are used as a base for the explanations and illustrations in this manual. Therefore some items may not apply to every model.

EMU25122

**F30B, F40F
OWNER'S MANUAL**
©2015 by Yamaha Motor Co., Ltd.
1st Edition, November 2015
All rights reserved.
Any reprinting or unauthorized use
without the written permission of
Yamaha Motor Co., Ltd.
is expressly prohibited.
Printed in Japan

Table of contents

Safety information	1	Start-in-gear protection	12
Outboard motor safety	1	Engine oil requirements	12
Propeller	1	Fuel requirements	13
Rotating parts	1	Gasoline	13
Hot parts	1	Muddy or acidic water	13
Electric shock	1	Anti-fouling paint	13
Power trim and tilt.....	1	Motor disposal requirements.....	13
Engine shut-off cord (lanyard)	1	Emergency equipment.....	14
Gasoline	1		
Gasoline exposure and spills	2		
Carbon monoxide	2	Components	15
Modifications	2	Components diagram.....	15
Boating safety	2	Optional items	16
Alcohol and drugs.....	2	Fuel tank.....	16
Personal flotation devices (PFDs).....	2	Fuel joint.....	17
People in the water.....	2	Fuel gauge	17
Passengers	2	Fuel tank cap.....	17
Overloading	2	Air vent screw	17
Avoid collisions.....	3	Yamaha Security System (Y-COP) ...	17
Weather.....	3	Remote control box	17
Passenger training	3	Remote control lever	18
Boating safety publications.....	3	Neutral interlock trigger	18
Laws and regulations	3	Neutral throttle lever	18
		Tiller handle	19
		Gear shift lever	19
General information	4	Throttle grip	19
Identification numbers record.....	4	Throttle indicator	19
Outboard motor serial number	4	Throttle friction adjuster.....	19
Key number	4	Engine shut-off cord (lanyard) and	
EC Declaration of Conformity		clip.....	20
(DoC).....	4	Engine stop button	20
CE Marking	5	Main switch.....	21
Read manuals and labels.....	6	Steering friction adjuster.....	21
Warning labels	6	Power trim and tilt switch on remote	
		control or tiller handle.....	22
Specifications and requirements	9	Power trim and tilt switch on bottom	
Specifications	9	cowling	22
Installation requirements	10	Variable trolling RPM switches	23
Boat horsepower rating	10	Trim tab with anode.....	23
Mounting motor	10	Tilt lock mechanism.....	24
Remote control requirements.....	11	Tilt support knob.....	24
Battery requirements.....	11	Cowling lock lever	24
Battery specifications	11	Flushing device	24
Propeller selection.....	11	Fuel filter/Water separator.....	25
		Alert indicator	25

Table of contents

Instruments and indicators	26	Checking power trim and tilt system.....	42
Indicators	26	Battery	42
Low oil pressure-alert indicator	26	Filling fuel	42
Overheat-alert indicator.....	26	Operating engine	43
Digital tachometer	26	Sending fuel (portable tank)	44
Tachometer	27	Starting engine	44
Trim meter.....	27	Checks after starting engine	47
Hour meter	27	Cooling water	47
Low oil pressure-alert indicator	27	Warming up engine.....	47
Overheat-alert indicator.....	28	Manual start and electric start models	47
Digital speedometer	28	Checks after engine warm up	48
Speedometer.....	28	Shifting	48
Fuel gauge	28	Stop switches	48
Trip meter / Clock / Voltmeter.....	29	Shifting	48
Fuel level-alert indicator	30	Stopping boat.....	49
Low battery voltage-alert indicator	30	Trolling	50
6Y8 Multifunction meters.....	30	Adjusting trolling speed	50
Engine control system.....	34	Stopping engine	50
Alert system	34	Procedure	50
Overheat alert.....	34	Trimming outboard motor.....	51
Low oil pressure alert	34	Adjusting trim angle (Power trim and tilt)	51
Installation	36	Adjusting trim angle for hydro tilt models	52
Installation	36	Adjusting boat trim.....	53
Mounting the outboard motor	36	Tilting up and down.....	53
Operation	38	Procedure for tilting up (hydro tilt models)	54
First-time operation	38	Procedure for tilting up (power trim and tilt models).....	55
Fill engine oil	38	Procedure for tilting down (hydro tilt models)	56
Breaking in engine.....	38	Procedure for tilting down (power trim and tilt models).....	56
Getting to know your boat	38	Shallow water	57
Checks before starting engine	38	Hydro tilt models.....	57
Fuel level.....	39	Power trim and tilt models	58
Remove the top cowling.....	39	Cruising in other conditions.....	59
Fuel system.....	39		
Controls	39		
Engine shut-off cord (lanyard)	40		
Engine oil.....	40		
Engine	41		
Flushing device	41		
Install top cowling.....	41		

Table of contents

Maintenance	60	INDEX	90
Transporting and storing outboard motor	60		
Storing outboard motor.....	60		
Procedure.....	61		
Lubrication.....	63		
Flushing power unit	63		
Cleaning the outboard motor.....	64		
Checking painted surface of outboard motor.....	64		
Periodic maintenance.....	65		
Replacement parts	65		
Severe operating conditions.....	65		
Maintenance chart 1.....	66		
Maintenance chart 2.....	68		
Greasing.....	69		
Cleaning and adjusting spark plug ...	70		
Inspecting idle speed.....	71		
Changing engine oil.....	71		
Inspecting wiring and connectors	74		
Checking propeller	74		
Removing propeller	75		
Installing propeller	75		
Changing gear oil	76		
Cleaning fuel tank.....	77		
Inspecting and replacing anode(s) ...	77		
Checking battery (for electric start models)	78		
Connecting the battery	79		
Disconnecting the battery.....	79		
Storing the battery	79		
Trouble Recovery	81		
Troubleshooting	81		
Temporary action in emergency.....	84		
Impact damage.....	84		
Replacing fuse.....	84		
Power trim and tilt will not operate ...	85		
Water separator-alert indicator blinks while cruising	85		
Starter will not operate	87		
Emergency starting engine.....	88		
Treatment of submerged motor.....	89		

EMU33623

Outboard motor safety

Observe these precautions at all times.

EMU336502

Propeller

People can be injured or killed if they come in contact with the propeller. The propeller can keep moving even when the motor is in neutral, and sharp edges of the propeller can cut even when stationary.

- Stop the engine when a person is in the water near you.
- Keep people out of reach of the propeller, even when the engine is off.

EMU33631

Rotating parts

Hands, feet, hair, jewelry, clothing, PFD straps, etc. can become entangled with internal rotating parts of the engine, resulting in serious injury or death.

Keep the top cowling in place whenever possible. Do not remove or replace the cowling with the engine running.

Only operate the engine with the cowling removed according to the specific instructions in the manual. Keep hands, feet, hair, jewelry, clothing, PFD straps, etc. away from any exposed moving parts.

EMU33641

Hot parts

During and after operation, engine parts are hot enough to cause burns. Avoid touching any parts under the top cowling until the engine has cooled.

EMU33651

Electric shock

Do not touch any electrical parts while starting or operating the engine. They can cause shock or electrocution.

EMU33661

Power trim and tilt

Body parts can be crushed between the mo-

tor and the clamp bracket when the motor is trimmed or tilted. Keep body parts out of this area at all times. Be sure no one is in this area before operating the power trim and tilt mechanism.

The power trim and tilt switches operate even when the main switch is off. Keep people away from the switches whenever working around the motor.

Never get under the lower unit while it is tilted, even when the tilt support lever is locked. Severe injury could occur if the outboard motor accidentally falls.

EMU33672

Engine shut-off cord (lanyard)

Attach the engine shut-off cord so that the engine stops if the operator falls overboard or leaves the helm. This prevents the boat from running away under power and leaving people stranded, or running over people or objects.

Always attach the engine shut-off cord to a secure place on your clothing or your arm or leg while operating. Do not remove it to leave the helm while the boat is moving. Do not attach the cord to clothing that could tear loose, or route the cord where it could become entangled, preventing it from functioning.

Do not route the cord where it is likely to be accidentally pulled out. If the cord is pulled during operation, the engine will shut off and you will lose most steering control. The boat could slow rapidly, throwing people and objects forward.

EMU33811

Gasoline

Gasoline and its vapors are highly flammable and explosive. Always, refuel according to the procedure on page 43 to reduce the risk of fire and explosion.

Safety information

EMU33821

Gasoline exposure and spills

Take care not to spill gasoline. If gasoline spills, wipe it up immediately with dry rags. Dispose of rags properly.

If any gasoline spills onto your skin, immediately wash with soap and water. Change clothing if gasoline spills on it.

If you swallow gasoline, inhale a lot of gasoline vapor, or get gasoline in your eyes, get immediate medical attention. Never siphon fuel by mouth.

EMU33901

Carbon monoxide

This product emits exhaust gases which contain carbon monoxide, a colorless, odorless gas which may cause brain damage or death when inhaled. Symptoms include nausea, dizziness, and drowsiness. Keep cockpit and cabin areas well ventilated. Avoid blocking exhaust outlets.

EMU33781

Modifications

Do not attempt to modify this outboard motor. Modifications to your outboard motor may reduce safety and reliability, and render the outboard unsafe or illegal to use.

EMU33741

Boating safety

This section includes a few of the many important safety precautions that you should follow when boating.

EMU33711

Alcohol and drugs

Never operate after drinking alcohol or taking drugs. Intoxication is one of the most common factors contributing to boating fatalities.

EMU40281

Personal flotation devices (PFDs)

Have an approved PFD on board for every occupant. Yamaha recommends that you must wear a PFD whenever boating. At a

minimum, children and non-swimmers should always wear PFDs, and everyone should wear PFDs when there are potentially hazardous boating conditions.

EMU33732

People in the water

Always watch carefully for people in the water, such as swimmers, skiers, or divers, whenever the engine is running. When someone is in the water near the boat, shift into neutral and stop the engine.

Stay away from swimming areas. Swimmers can be hard to see.

The propeller can keep moving even when the motor is in neutral. Stop the engine when a person is in the water near you.

EMU33752

Passengers

Consult your boat manufacturer's instructions for details about appropriate passenger locations in your boat and be sure all passengers are positioned properly before accelerating and when operating above an idle speed. Standing or sitting in non-designated locations may result in being thrown either overboard or within the boat due to waves, wakes, or sudden changes in speed or direction. Even when people are positioned properly, alert your passengers if you must make any unusual maneuver. Always avoid jumping waves or wakes.

EMU33762

Overloading

Do not overload the boat. Consult the boat capacity plate or boat manufacturer for maximum weight and number of passengers. Be sure that weight is properly distributed according to the boat manufacturer's instructions. Overloading or incorrect weight distribution can compromise the boats handling and lead to an accident, capsizing or swamping.

EMU33773

Avoid collisions

Scan constantly for people, objects, and other boats. Be alert for conditions that limit your visibility or block your vision of others.

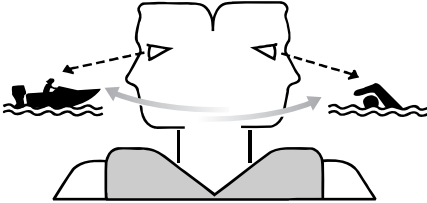

ZMU06025

Operate defensively at safe speeds and keep a safe distance away from people, objects, and other boats.

- Do not follow directly behind other boats or waterskiers.
- Avoid sharp turns or other maneuvers that make it hard for others to avoid you or understand where you are going.
- Avoid areas with submerged objects or shallow water.
- Ride within your limits and avoid aggressive maneuvers to reduce the risk of loss of control, ejection, and collision.
- Take early action to avoid collisions. Remember, boats do not have brakes, and stopping the engine or reducing throttle can reduce the ability to steer. If you are not sure that you can stop in time before hitting an obstacle, apply throttle and turn in another direction.

EMU33791

Weather

Stay informed about the weather. Check weather forecasts before boating. Avoid boating in hazardous weather.

EMU33881

Passenger training

Make sure at least one other passenger is trained to operate the boat in the event of an emergency.

EMU33891

Boating safety publications

Be informed about boating safety. Additional publications and information can be obtained from many boating organizations.

EMU33601

Laws and regulations

Know the marine laws and regulations where you will be boating- and obey them. Several sets of rules prevail according to geographic location, but all are basically the same as the International Rules of the Road.

General information

EMU25172

Identification numbers record

EMU25186

Outboard motor serial number

The outboard motor serial number is stamped on the label attached to the port side of the clamp bracket.

Record your outboard motor serial number in the spaces provided to assist you in ordering spare parts from your Yamaha dealer or for reference in case your outboard motor is stolen.

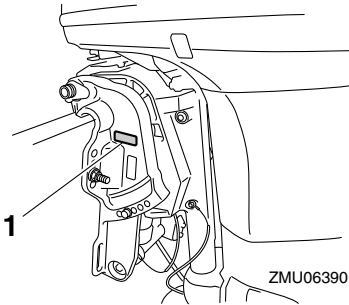

ZMU06390

1. Outboard motor serial number location

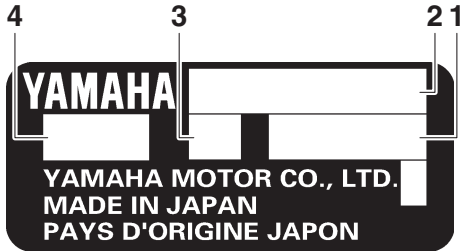

ZMU01692

1. Serial number
2. Model name
3. Motor transom height
4. Approved model code

EMU25192

Key number

If a main key switch is equipped with the motor, the key identification number is stamped on your key as shown in the illustration. Record this number in the space provided for reference in case you need a new key.



ZMU01693

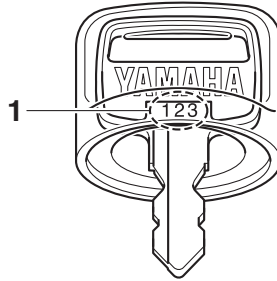

ZMU01694

1. Key number

EMU38981

EC Declaration of Conformity (DoC)

This declaration is included with outboard motors that conform to European regulations.

This outboard motor conforms to certain portions of the European Parliament directive relating to machinery.

Each conformed outboard motor accompanied with EC DoC. EC DoC contains the following information;

- Name of Engine Manufacture
- Model name
- Product code of model (Approved model code)
- Code of conformed directives

EMU38995

CE Marking

This label is affixed to outboard motors that conform to European regulations.

Outboard motors affixed with this “CE” marking conform with the directives of; 2006/42/EC, 94/25/EC - 2003/44/EC, 2014/30/EU, and 2004/108/EC, 2013/53/EU.

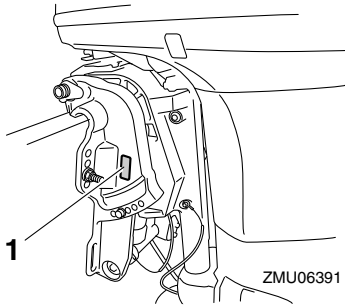

1. CE marking location



ZMU06040

General information

EMU33524

Read manuals and labels

Before operating or working on this outboard motor:

- Read this manual.
- Read any manuals supplied with the boat.
- Read all labels on the outboard motor and the boat.

If you need any additional information, contact your Yamaha dealer.

EMU33836

Warning labels

If these labels are damaged or missing, contact your Yamaha dealer for replacements.

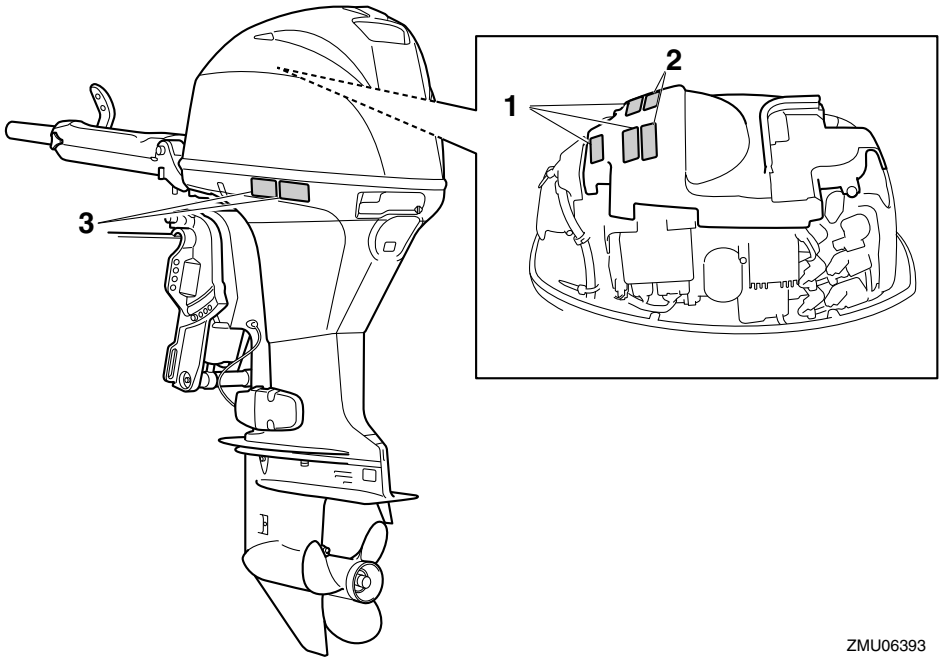

ZMU06393

1

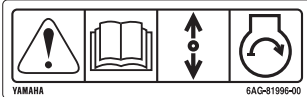

2



3

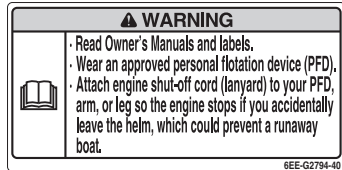

EMU33913

Contents of labels

The above warning labels mean as follows.

1

EWM01682



Emergency starting does not have start-in-gear protection. Ensure shift control is in neutral before starting engine.

2

EWM01682



- Keep hands, hair, and clothing away from rotating parts while the engine is running.
- Do not touch or remove electrical parts when starting or during operation.

3

EWM01672



- Read Owner's Manuals and labels.
- Wear an approved personal flotation device (PFD).
- Attach engine shut-off cord (lanyard) to your PFD, arm, or leg so the engine stops if you accidentally leave the helm, which could prevent a runaway boat.

ZMU05706

General information

EMU33844

Symbols

The following symbols mean as follows.

Notice/Warning



ZMU05696

Read Owner's Manual



ZMU05664

Hazard caused by continuous rotation

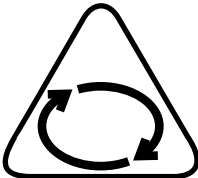

ZMU05665

Electrical hazard

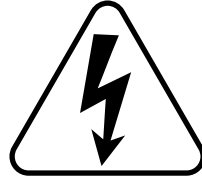

ZMU05666

Remote control lever/gear shift lever operating direction, dual direction



ZMU05667

Engine start/ Engine cranking

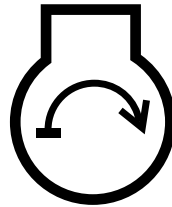

ZMU05668

Specifications and requirements

EMU34522

Specifications

TIP:

“(AL)” stated in the specification data below represents the numerical value for the aluminum propeller installed.

Likewise, “(SUS)” represents the value for stainless steel propeller installed and “(PL)” for plastic propeller installed.

EMU2821V

Dimension and weight:

Overall length:

1362 mm (53.6 in) (F30BEHD,
F40FEHD)

698 mm (27.5 in) (F30BET, F40FED,
F40FET)

Overall width:

384 mm (15.1 in)

Overall height S:

1228 mm (48.3 in) (F30BET,
F40FEHD, F40FET)

Overall height L:

1350 mm (53.1 in)

Motor transom height S:

414 mm (16.3 in) (F30BET,
F40FEHD, F40FET)

Motor transom height L:

536 mm (21.1 in)

Dry weight (AL) S:

94 kg (207 lb) (F30BET, F40FET)

98 kg (216 lb) (F40FEHD)

Dry weight (AL) L:

102 kg (225 lb) (F30BEHD,
F40FEHD)

95 kg (209 lb) (F40FED)

98 kg (216 lb) (F30BET, F40FET)

Performance:

Full throttle operating range:

5000–6000 r/min

Rated power:

22.1 kW (30 HP) (F30BEHD,
F30BET)

29.4 kW (40 HP) (F40FED,
F40FEHD, F40FET)

Idle speed (in neutral):

750–850 r/min

Power unit:

Type:

4-stroke SOHC L3 6 valves

Total displacement:

747 cm³ (45.6 c.i.)

Bore × stroke:

65.0 × 75.0 mm (2.56 × 2.95 in)

Ignition system:

CDI

Spark plug (NGK):

DPR6EB-9

Spark plug gap:

0.8–0.9 mm (0.031–0.035 in)

Steering system:

Remote steering (F30BET, F40FED,
F40FET)

Tiller handle (F30BEHD, F40FEHD)

Starting system:

Electric starter

Starting carburetion system:

Fuel injection

Valve clearance IN (cold engine):

0.15–0.25 mm (0.0059–0.0098 in)

Valve clearance EX (cold engine):

0.25–0.35 mm (0.0098–0.0138 in)

Battery rating (CCA/EN):

430–1080 A

Battery rating (20HR/IEC):

70 Ah

Maximum generator output:

17 A

Lower unit:

Gear shift positions:

Forward-neutral-reverse

Specifications and requirements

Gear ratio:

2.00 (26/13)

Trim and tilt system:

Hydro tilt (F30BEHD, F40FED,
F40FEHD)

Power trim and tilt (F30BET,
F40FET)

Propeller mark:

G

Fuel and oil:

Recommended fuel:

Regular unleaded gasoline

Min. research octane number (RON):

90

Fuel tank capacity:

25 L (6.60 US gal, 5.50 Imp.gal)

Recommended engine oil:

YAMALUBE 4 or 4-stroke outboard
motor oil

Recommended engine oil grade 1:

SAE 10W-30/10W-40/5W-30

API SE/SF/SG/SH/SJ/SL

Engine oil quantity (without oil filter re-
placement):

1.5 L (1.59 US qt, 1.32 Imp.qt)

Engine oil quantity (with oil filter replace-
ment):

1.7 L (1.80 US qt, 1.50 Imp.qt)

Lubrication system:

Wet sump

Recommended gear oil:

YAMALUBE outboard gear oil or Hy-
poid gear oil

Recommended gear oil grade:

SAE 90 API GL-4

Gear oil quantity:

0.430 L (0.455 US qt, 0.378 Imp.qt)

Tightening torque:

Spark plug:

17 Nm (1.73 kgf-m, 12.5 ft-lb)

Propeller nut:

34 Nm (3.47 kgf-m, 25.1 ft-lb)

Engine oil drain bolt:

27 Nm (2.75 kgf-m, 19.9 ft-lb)

Engine oil filter:

18 Nm (1.84 kgf-m, 13.3 ft-lb)

Noise and vibration level:

Operator sound pressure level (ICOMIA
39/94):

80.7 dB(A)

Vibration on tiller handle (ICOMIA 38/94):

Vibration on tiller handle is under 2.5
m/s² (F30BEHD, F40FEHD)

EMU33556

Installation requirements

EMU33565

Boat horsepower rating

EWM01561



Overpowering a boat can cause severe instability.

Before installing the outboard motor(s), confirm that the total horsepower of your outboard motor(s) does not exceed the boat's maximum horsepower rating. See the boat's capacity plate or contact the manufacturer.

EMU33572

Mounting motor

EWM01571



- **Improper mounting of the outboard motor could result in hazardous conditions such as poor handling, loss of control, or fire hazards.**
 - **Because the motor is very heavy, special equipment and training is required to mount it safely.**
-

Your dealer or other person experienced in proper rigging should mount the motor using correct equipment and complete rigging instructions. For further information, see page

Specifications and requirements

36.

EMU33582

Remote control requirements

EWMO1581



- If the engine starts in gear, the boat can move suddenly and unexpectedly, possibly causing a collision or throwing passengers overboard.
- If the engine ever starts in gear, the start-in-gear protection device is not working correctly and you should discontinue using the outboard. Contact your Yamaha dealer.

The remote control unit must be equipped with a start-in-gear protection device(s). This device prevents the engine from starting unless it is in neutral.

EMU25695

Battery requirements

EMU25723

Battery specifications

Battery rating (CCA/EN):

430–1080 A

Battery rating (20HR/IEC):

70 Ah

The engine cannot be started if battery voltage is too low.

EMU36293

Mounting battery

Mount the battery holder securely in a dry, well-ventilated, vibration-free location in the boat. **WARNING! Do not put flammable items, or loose heavy or metal objects in the same compartment as the battery. Fire, explosion or sparks could result.**

[EWMO1821]

Battery cable

The battery cable size and length are critical. Consult your Yamaha dealer about the bat-

tery cable size and length.

EMU36303

Multiple batteries

To connect multiple batteries, such as for multiple engine configurations or for an accessory battery, consult your Yamaha dealer about battery selection and correct wiring.

Battery isolator

Your outboard motor is capable of charging an accessory battery separate from the starting battery using an optional isolator lead. Contact your Yamaha dealer for installation of an optional isolator lead with over-current protection.

EMU34196

Propeller selection

Next to selecting an outboard motor, selecting the right propeller is one of the most important purchasing decisions a boater can make. The type, size, and design of your propeller have a direct impact on acceleration, top speed, fuel economy, and even engine life. Yamaha designs and manufactures propellers for every Yamaha outboard motor and every application.

Your outboard motor came with a Yamaha propeller selected to perform well over a range of applications, but there may be uses where a different propeller would be more appropriate.

Your Yamaha dealer can help you select the right propeller for your boating needs. Select a propeller that will allow the engine to reach the middle or upper half of the operating range at full throttle with the maximum boatload. Generally, select a larger pitch propeller for a smaller operating load and a smaller pitch propeller for a heavier load. If you carry loads that vary widely, select the propeller that lets the engine run in the proper range for your maximum load but remember that

Specifications and requirements

you may need to reduce your throttle setting to stay within the recommended engine speed range when carrying lighter loads. To check the propeller, see page 74.

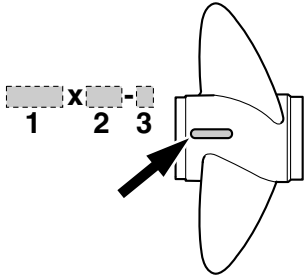

ZMU04606

1. Propeller diameter in inches
2. Propeller pitch in inches
3. Type of propeller (propeller mark)

EMU25771

Start-in-gear protection

Yamaha outboard motors or Yamaha-approved remote control units are equipped with start-in-gear protection device(s). This feature permits the engine to be started only when it is in neutral. Always select neutral before starting the engine.

EMU41953

Engine oil requirements

Select an oil grade according to the average temperatures in the area where the outboard motor will be used.

Recommended engine oil:

YAMALUBE 4 or 4-stroke outboard motor oil

Recommended engine oil grade 1:

SAE 10W-30/10W-40/5W-30
API SE/SF/SG/SH/SJ/SL

Recommended engine oil grade 2:

SAE 15W-40/20W-40/20W-50
API SH/SJ/SL

Engine oil quantity (without oil filter replacement):

1.5 L (1.59 US qt, 1.32 Imp.qt)

Engine oil quantity (with oil filter replacement):

1.7 L (1.80 US qt, 1.50 Imp.qt)

If oil grades listed under Recommended engine oil grade 1 are not available, select an alternative oil grade listed under Recommended engine oil grade 2.

Recommended engine oil grade 1

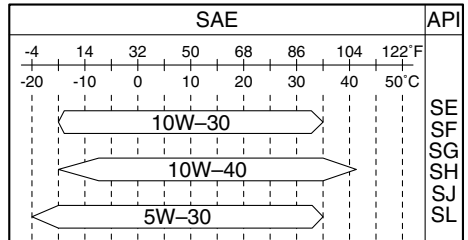

ZMU06854

Recommended engine oil grade 2

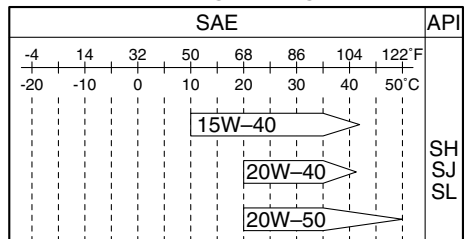

ZMU06855

Specifications and requirements

EMU36361

Fuel requirements

EMU40202

Gasoline

Use a good quality gasoline that meets the minimum octane rating. If knocking or ping-ing occurs, use a different brand of gasoline or premium unleaded fuel.

Recommended fuel:

Regular unleaded gasoline

Min. research octane number (RON):

90

ECM01982

NOTICE

- **Do not use leaded gasoline. Leaded gasoline can seriously damage the engine.**
- **Avoid getting water and contaminants in the fuel tank. Contaminated fuel can cause poor performance or engine damage. Use only fresh gasoline that has been stored in clean containers.**

Gasohol

There are two types of gasohol: gasohol containing ethanol (E10) and that containing methanol. Ethanol can be used if the ethanol content does not exceed 10% and the fuel meets the minimum octane ratings. E85 is a fuel containing 85% ethanol and must not be used in your outboard motor. All ethanol blends containing more than 10% ethanol can cause fuel system damage or cause engine starting and running problems. Yamaha does not recommend gasohol containing methanol because it can cause fuel system damage or engine performance problems. It is recommended that you install a water-separating marine fuel filter assembly (10 micron minimum) between your boat's fuel tank and outboard motor when using ethanol.

Ethanol is known to allow moisture to be absorbed into boat fuel tanks and systems. Moisture in the fuel can cause corrosion of metallic fuel system components, starting and running complaints and require additional fuel system maintenance.

EMU36881

Muddy or acidic water

Yamaha strongly recommends that you have your dealer install the optional chromium-plated water pump kit if you use the outboard motor in muddy or acidic water conditions. However, depending on the model it might not be required.

EMU36331

Anti-fouling paint

A clean hull improves boat performance. The boat bottom should be kept as clean of marine growth as possible. If necessary, the boat bottom can be coated with an anti-fouling paint approved for your area to inhibit marine growth.

Do not use anti-fouling paint which includes copper or graphite. These paints can cause more rapid engine corrosion.

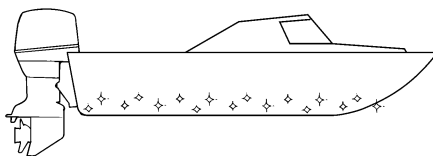

ZMU05176

EMU36342

Motor disposal requirements

Never illegally discard (dump) the motor. Yamaha recommends consulting the dealer about discarding the motor.

Specifications and requirements

EMU36353

Emergency equipment

Keep the following items onboard in case there is trouble with the outboard motor.

- A tool kit with assorted screwdrivers, pliers, wrenches (including metric sizes), and electrical tape.
- Waterproof flashlight with extra batteries.
- An extra engine shut-off cord (lanyard) with clip.
- Spare parts, such as an extra set of spark plugs.

Consult your Yamaha dealer for details.

EMU46721

Components diagram

TIP:

* May not be exactly as shown; also may not be included as standard equipment on all models (order from dealer).

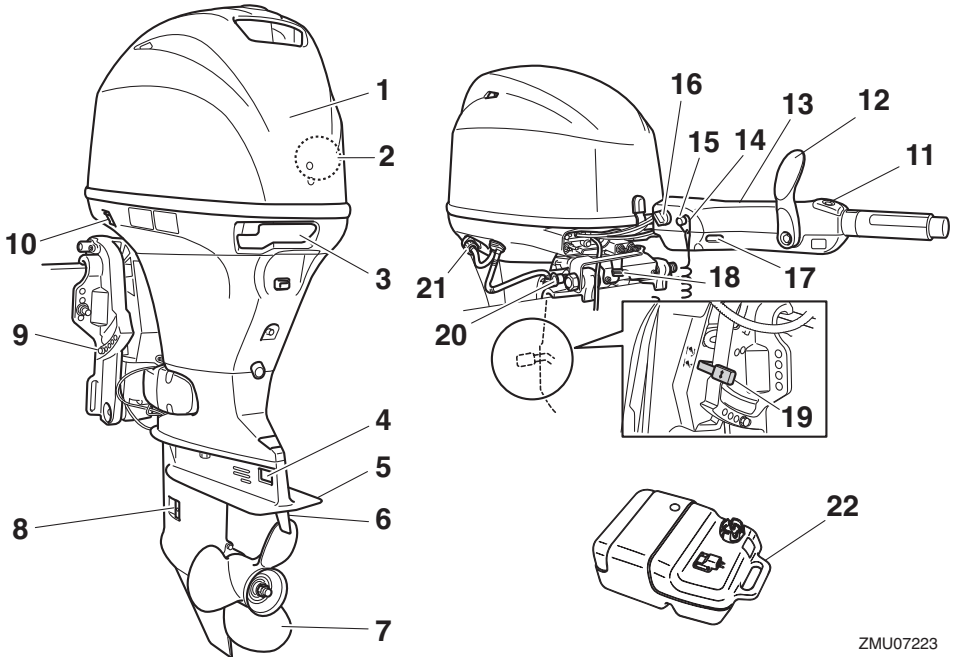

1. Top cowling
2. Water separator
3. Cowling lock lever
4. Anode
5. Anti-cavitation plate
6. Trim tab (anode)
7. Propeller*
8. Cooling water inlet
9. Clamp bracket
10. Power trim and tilt switch*
11. Variable trolling RPM switch*
12. Gear shift lever*
13. Tiller handle*
14. Clip*
15. Engine stop button/Engine shut-off switch*

16. Main switch*
17. Alert indicator*
18. Steering friction adjuster*
19. Tilt lock lever*
20. Tilt support knob
21. Flushing device
22. Fuel tank

ZMU07223

Components

EMU46731

Optional items

The following items are available from your Yamaha dealer. For details, consult your Yamaha dealer.

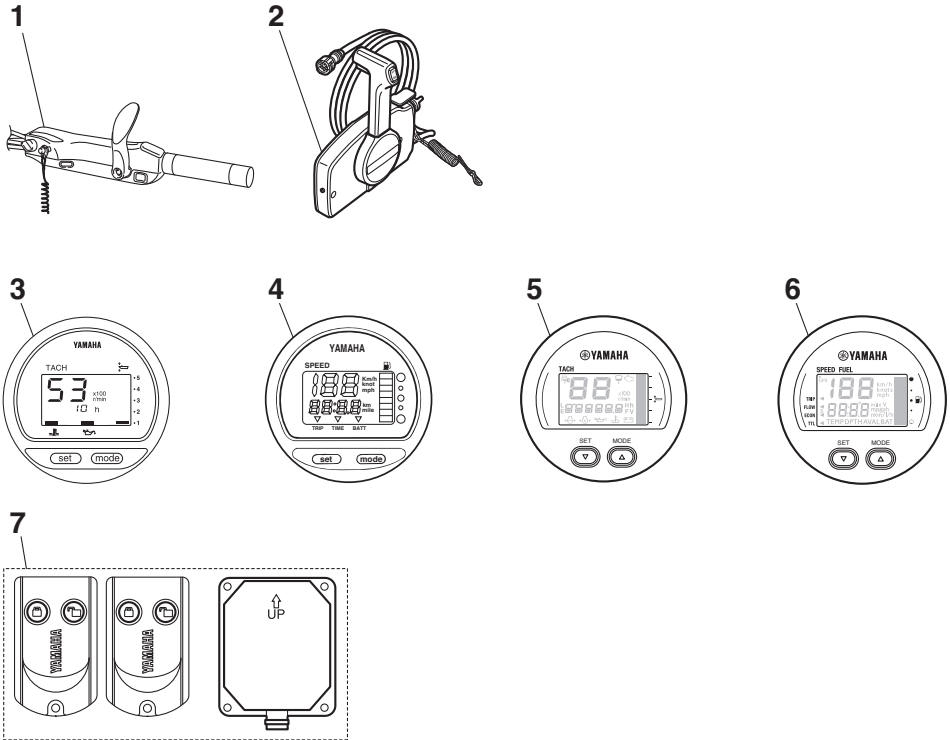

1. Tiller handle
2. Remote control box (side mount type)
3. Digital tachometer
4. Digital speedometer
5. 6Y8 Multifunction tachometer
6. 6Y8 Multifunction speed & fuel meter
7. Yamaha Security System (Y-COP)

EMU25804

Fuel tank

If your model was equipped with a portable fuel tank, its function is as follows.

ZMU08550

EWM00021

WARNING

The fuel tank supplied with this engine is its dedicated fuel reservoir and must not be used as a fuel storage container. Commercial users should conform to relevant licensing or approval authority regulations.

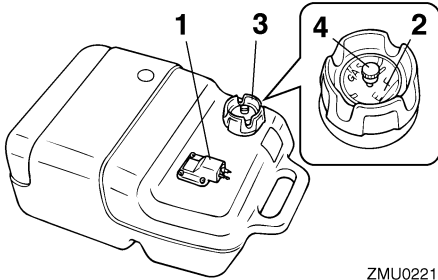

1. Fuel joint
2. Fuel gauge
3. Fuel tank cap
4. Air vent screw

EMU25831

Fuel joint

This joint is used to connect the fuel line.

EMU25842

Fuel gauge

This gauge is located on either the fuel tank cap or on the fuel joint base. It shows the approximate amount of fuel remaining in the tank.

EMU25851

Fuel tank cap

This cap seals the fuel tank. When removed, the tank can be filled with fuel. To remove the cap, turn it counterclockwise.

EMU25861

Air vent screw

This screw is on the fuel tank cap. To loosen the screw, turn it counterclockwise.

EMU46750

Yamaha Security System (Y-COP)

ECM02461

NOTICE

The Yamaha Security System is sold in conformity with the relevant laws and regulations regarding radio wave transmission. Therefore, if this product is used outside the country where it was sold, it may violate the laws or regulations re-

garding radio wave transmission in the country it is used in. For details, consult your Yamaha dealer.

The Yamaha Security System, which protects against theft, consists of the receiver and remote control transmitters. The Yamaha Security System is available from your Yamaha dealer. For details, consult your Yamaha dealer.

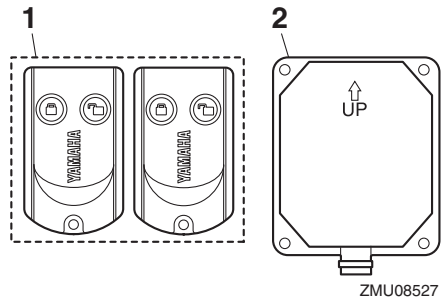

1. Remote control transmitter
2. Receiver

The engine cannot be started if the security system is in the lock mode. The engine can be started only in the unlock mode. For more information, see the installation and owner's manual included with the security system.

EMU26182

Remote control box

The remote control lever actuates both the shifter and the throttle. The electrical switches are mounted on the remote control box.

Components

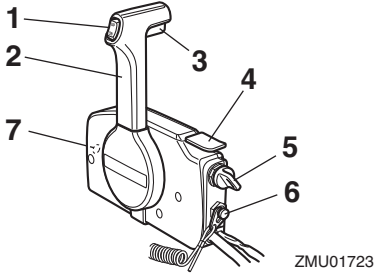

1. Power trim and tilt switch
2. Remote control lever
3. Neutral interlock trigger
4. Neutral throttle lever
5. Main switch
6. Engine shut-off switch
7. Throttle friction adjuster

EMU26191

Remote control lever

Moving the lever forward from the neutral position engages forward gear. Pulling the lever back from neutral engages reverse. The engine will continue to run at idle until the lever is moved about 35° (a detent can be felt). Moving the lever farther opens the throttle, and the engine will begin to accelerate.

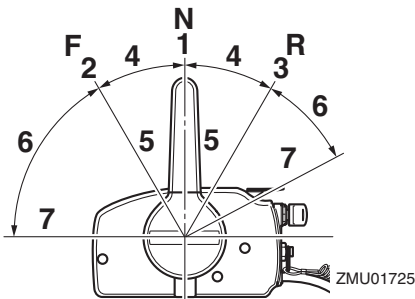

1. Neutral "N"
2. Forward "F"
3. Reverse "R"
4. Shift
5. Fully closed

6. Throttle
7. Fully open

EMU26202

Neutral interlock trigger

To shift out of neutral, first pull the neutral interlock trigger up.

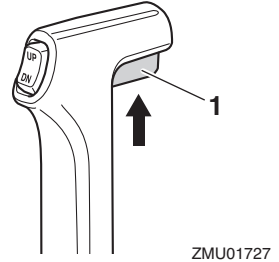

1. Neutral interlock trigger

EMU26213

Neutral throttle lever

To open the throttle without shifting into either forward or reverse, put the remote control lever in the neutral position and lift the neutral throttle lever.

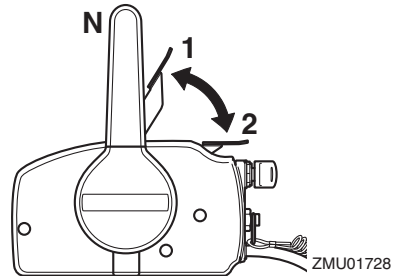

1. Fully open
2. Fully closed

TIP:

The neutral throttle lever will operate only when the remote control lever is in neutral. The remote control lever will operate only

when the neutral throttle lever is in the closed position.

EMU25914

Tiller handle

To change direction, move the tiller handle to the left or right as necessary.

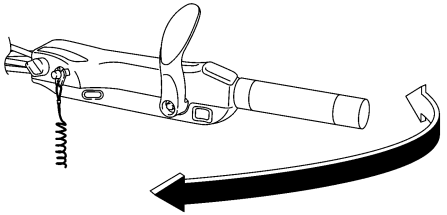

ZMU05203

EMU25925

Gear shift lever

Move the gear shift lever forward to engage the forward gear or rearward to engage the reverse gear.

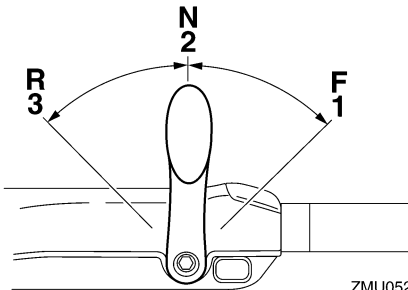

ZMU05204

1. Forward "F"
2. Neutral "N"
3. Reverse "R"

EMU25943

Throttle grip

The throttle grip is on the tiller handle. Turn the grip counterclockwise to increase speed and clockwise to decrease speed.

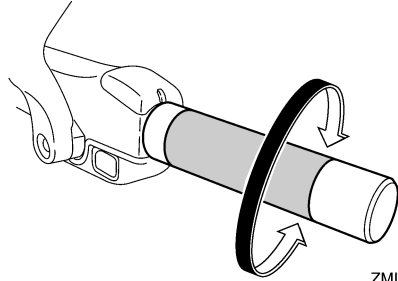

ZMU05205

EMU25963

Throttle indicator

The fuel consumption curve on the throttle indicator shows the relative amount of fuel consumed for each throttle position. Choose the setting that offers the best performance and fuel economy for the desired operation.

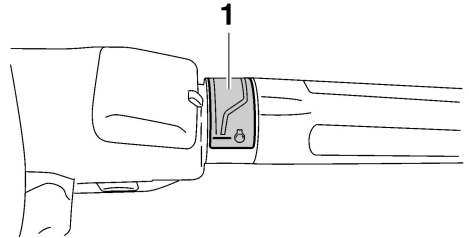

ZMU05206

1. Throttle indicator

EMU25977

Throttle friction adjuster

A friction device provides adjustable resistance to movement of the throttle grip or the remote control lever, and can be set according to operator preference.

To increase resistance, turn the adjuster clockwise. To decrease resistance, turn the adjuster counterclockwise. **WARNING! Do not overtighten the friction adjuster. If there is too much resistance, it could be difficult to move the remote control lever**

Components

or throttle grip, which could result in an accident. [EWM00033]

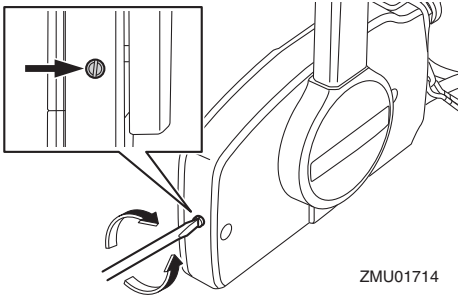

ZMU0174

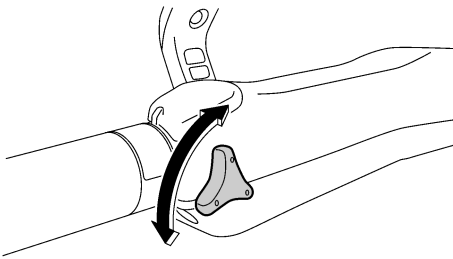

ZMU05207

When constant speed is desired, tighten the adjuster to maintain the desired throttle setting.

EMU25996

Engine shut-off cord (lanyard) and clip

The clip must be attached to the engine shut-off switch for the engine to run. The cord should be attached to a secure place on the operator's clothing, or arm or leg. Should the operator fall overboard or leave the helm, the cord will pull out the clip, stopping ignition to the engine. This will prevent the boat from running away under power. **WARNING! Attach the engine shut-off cord to a secure place on your clothing, or your arm or leg while operating. Do not attach the cord to clothing that could tear loose. Do not route the cord where it could become en-**

tangled, preventing it from functioning. Avoid accidentally pulling the cord during normal operation. Loss of engine power means the loss of most steering control. Also, without engine power, the boat could slow rapidly. This could cause people and objects in the boat to be thrown forward. [EWM00123]

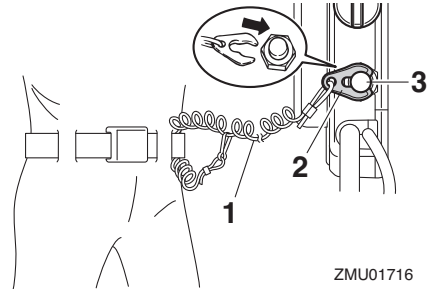

ZMU01716

1. Cord
2. Clip
3. Engine shut-off switch

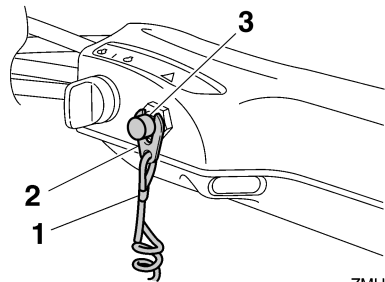

ZMU05208

1. Cord
2. Clip
3. Engine shut-off switch

EMU26004

Engine stop button

The engine stop button stops the engine when the button is pushed.

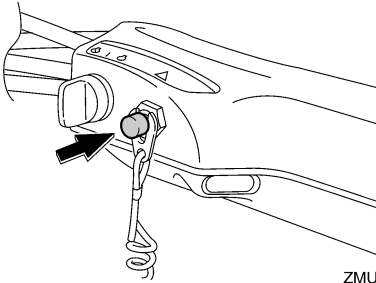

ZMU05209

EMU26092

Main switch

The main switch controls the ignition system; its operation is described below.

- “OFF” (off)

With the main switch in the “OFF” (off) position, the electrical circuits are off, and the key can be removed.

- “ON” (on)

With the main switch in the “ON” (on) position, the electrical circuits are on, and the key cannot be removed.

- “START” (start)

With the main switch in the “START” (start) position, the starter motor turns to start the engine. When the key is released, it returns automatically to the “ON” (on) position.

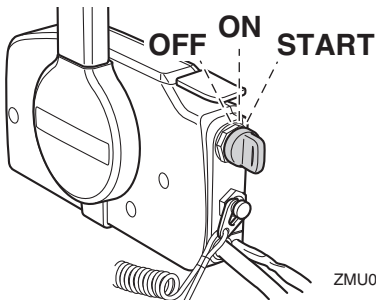

ZMU01718

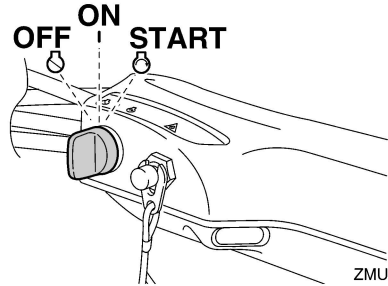

ZMU05210

EMU31433

Steering friction adjuster

A friction device provides adjustable resistance to the steering mechanism, and can be set according to operator preference. An adjuster lever is located on the bottom of the tiller handle bracket.

To increase resistance, turn the lever to the port side “A”.

To decrease resistance, turn the lever to the starboard side “B”.

EWMM00041

WARNING

Do not overtighten the friction adjuster. If there is too much resistance, it could be difficult to steer, which could result in an accident.

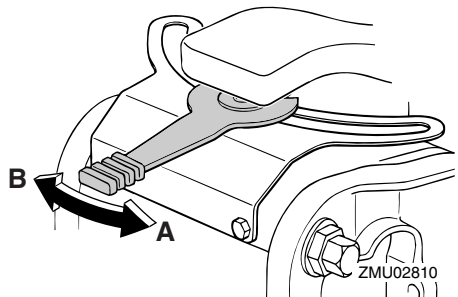

ZMU02810

If the resistance does not increase even when the lever is turned to the port side “A”, make sure that the nut is tightened to the specified torque.

Components

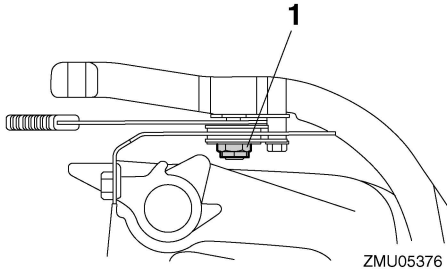

1. Nut

Nut tightening torque:
6 Nm (0.61 kgf-m, 4.4 ft-lb)

TIP:

- Steering movement is blocked when the adjuster lever is set to the “A” position.
- Check the tiller handle for smooth movement when the lever is turned to the starboard side “B”.
- Do not apply lubricants such as grease to the friction areas of the steering friction adjuster.

EMU26144

Power trim and tilt switch on remote control or tiller handle

The power trim and tilt system adjusts the outboard motor angle in relation to the transom. Pressing the switch “UP” (up) trims the outboard motor up, and then tilts it up. Pressing the switch “DN” (down) tilts the outboard motor down and trims it down. When the switch is released, the outboard motor will stop in its current position.

For instructions on using the power trim and tilt switch, see pages 51 and 53.

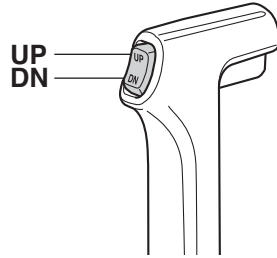

ZMU01720

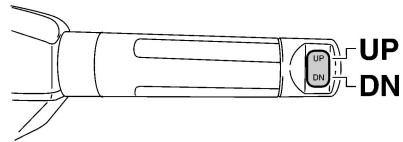

ZMU05211

EMU26156

Power trim and tilt switch on bottom cowling

The power trim and tilt switch is located on the side of the bottom cowling. Pushing the switch “UP” (up) trims the outboard motor up, and then tilts it up. Pushing the switch “DN” (down) tilts the outboard motor down and trims it down. When the switch is released, the outboard motor will stop in its current position.

For instructions on using the power trim and tilt switch, see page 53.

EWM01032

WARNING

Use the power trim and tilt switch located on the bottom cowling only when the boat is at a complete stop with the engine off. Attempting to use this switch while the boat is moving could increase the risk of falling overboard and could distract the

operator, increasing the risk of collision with another boat or an obstacle.

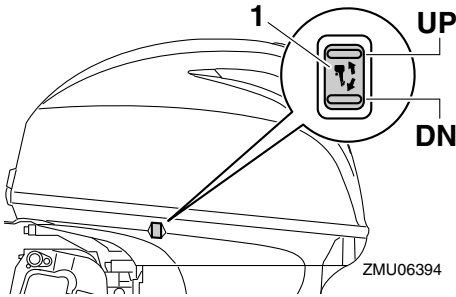

1. Power trim and tilt switch

EMU30903

Variable trolling RPM switches

The trolling speed can be adjusted when the outboard motor is trolling. Press the “UP” switch to increase the trolling speed and press the “DN” switch to decrease the trolling speed.

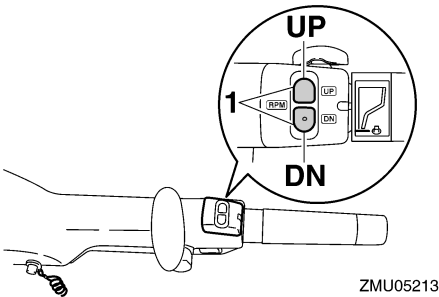

1. Variable trolling RPM switch

TIP:

- The trolling speed changes approximately 50 r/min each time a switch is pressed.
- If the trolling speed has been adjusted, the engine returns to the normal trolling speed when the engine is stopped and restarted or when the engine speed exceeds ap-

proximately 3000 r/min.

- For instructions on using the variable trolling RPM switches, see page 50.

EMU26246

Trim tab with anode

EWM00841

WARNING

An improperly adjusted trim tab could cause difficult steering. Always test run after the trim tab has been installed or replaced to be sure steering is correct. Be sure you have tightened the bolt after adjusting the trim tab.

The trim tab should be adjusted so that the steering control can be turned to either the right or left by applying the same amount of force.

If the boat tends to veer to the left (port side), turn the trim tab rear end to the port side “A” in the figure. If the boat tends to veer to the right (starboard side), turn the trim tab end to the starboard side “B” in the figure.

ECM00841

NOTICE

The trim tab also serves as an anode to protect the engine from electrochemical corrosion. Never paint the trim tab as it will become ineffective as an anode.

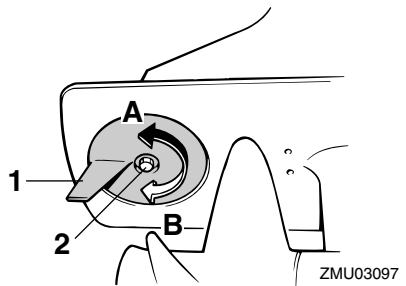

1. Trim tab
2. Bolt

Components

Bolt tightening torque:
18 Nm (1.84 kgf-m, 13.3 ft-lb)



EMU26313

Tilt lock mechanism

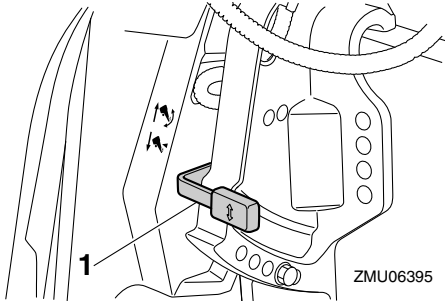
The tilt lock mechanism is used to prevent the outboard motor from lifting out of the water when in reverse gear.



1. Tilt lock lever

To lock it, set the tilt lock lever in the “” (lock) position. To release, push the tilt lock lever in the “” (release) position.

EMU26322

Tilt support knob

To keep the outboard motor in the tilted up position, push the tilt support knob under the swivel bracket.

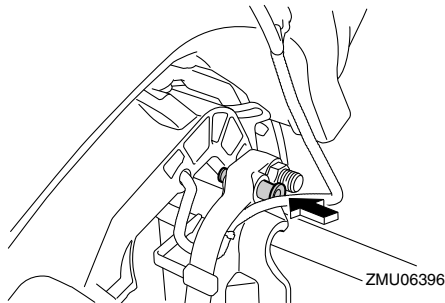

ECM00661

NOTICE

Do not use the tilt support lever or knob when trailering the boat. The outboard

motor could shake loose from the tilt support and fall. If the motor cannot be trailered in the normal running position, use an additional support device to secure it in the tilt position.

EMU40762

Cowling lock lever

The cowling lock levers are used to secure the top cowling.

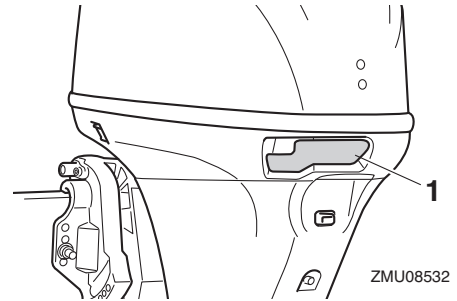

1. Cowling lock lever(s)

EMU26464

Flushing device

This device is used to clean the cooling water passages of the motor using a garden hose and tap water.

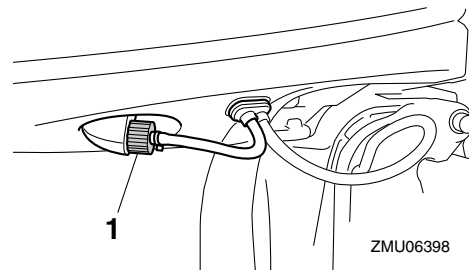

1. Flushing device

TIP:

For details on usage, see page 63.

EMU35564

Fuel filter/Water separator

This engine has a combination fuel filter/water separator and associated alert system. If water separated from the fuel exceeds a specific volume, the alert device of 6Y8 Multifunction Tachometer will activate.

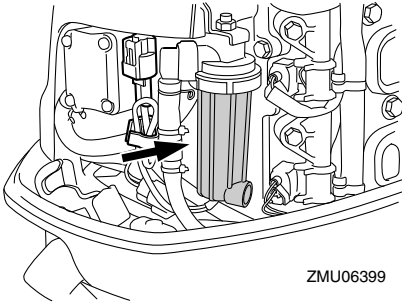

ZMU06399

Activation of alert device

- The water separator-alert indicator of 6Y8 Multifunction Tachometer will blink.
- The buzzer will sound intermittently only when the gear shift is in neutral.
- If the alert system has activated, stop the engine and consult a Yamaha dealer immediately.

EMU26305

Alert indicator

If the engine develops a condition which is cause for alert, the indicator lights up. For details on how to read the alert indicator, see page 34.

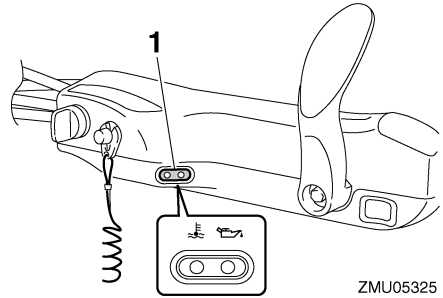

ZMU05325

1. Alert indicator

Instruments and indicators

EMU36016

Indicators

EMU36025

Low oil pressure-alert indicator

If oil pressure drops too low, this indicator will light up. For further information, see page 34.

ECM00023

NOTICE

- Do not continue to run the engine if the low oil pressure-alert indicator is on and the engine oil level is lower. Serious engine damage will occur.
- The low oil pressure-alert indicator does not indicate the engine oil level. Use the oil dipstick to check the remaining oil quantity. For further information, see page 40.

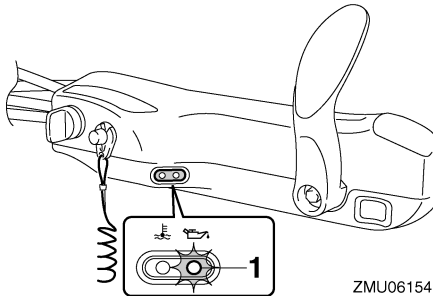

ZMU06154

1. Low oil pressure-alert indicator

EMU36034

Overheat-alert indicator

If the engine temperature rises too high, this indicator will light up. For further information on reading the indicator, see page 34.

ECM00053

NOTICE

Do not continue to run the engine if the overheat-alert indicator is on. Serious engine damage will occur.

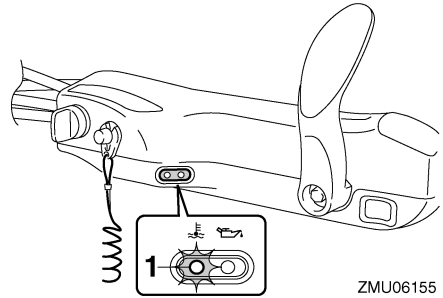

ZMU06155

1. Overheat-alert indicator

EMU26494

Digital tachometer

The tachometer shows the engine speed and has the following functions.

All segments of the display will light momentarily after the main switch is turned on and will return to normal thereafter.

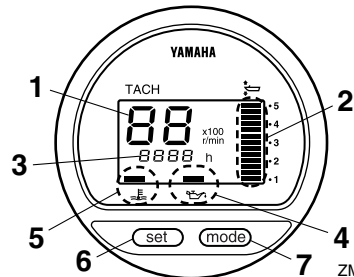

ZMU03601

1. Tachometer
2. Trim meter
3. Hour meter
4. Low oil pressure-alert indicator
5. Overheat-alert indicator
6. Set button
7. Mode button

TIP:

The water separator and engine trouble-alert indicators only operate when the engine is equipped with the appropriate functions.

Instruments and indicators

EMU36051

Tachometer

The tachometer displays engine speed in hundreds of revolutions per minute (r/min). For example, if the tachometer display reads “22” then the engine speed is 2200 r/min.

EMU26622

Trim meter

This meter shows the trim angle of your out-board motor.

- Memorize the trim angles that work best for your boat under different conditions. Adjust the trim angle to the desired using the power trim and tilt switch.
- If the trim angle of your motor exceeds the trim operating range, the top segment on the trim meter display will blink.

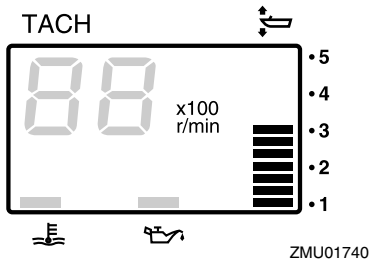

EMU26652

Hour meter

This meter shows the number of hours the engine has been run. It can be set to show the total number of hours or the number of hours for the current trip. The display can also be turned on and off.

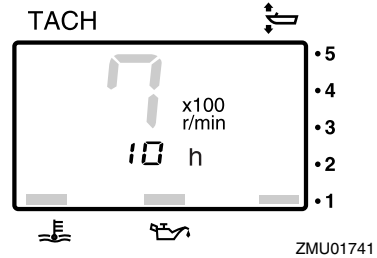

To change the display format, press the “mode” (mode) button. The display can show total hours or trip hours, or turn off.

To reset the trip hours, simultaneously press the “set” (set) and “mode” (mode) buttons for more than 1 second while the trip hours are displayed. This resets the trip counter to 0 (zero).

The total number of hours the engine has been run cannot be reset.

EMU26525

Low oil pressure-alert indicator

If oil pressure drops too low, the alert indicator will start to blink. For further information, see page 34.

ECM00023

NOTICE

- Do not continue to run the engine if the low oil pressure-alert indicator is on and the engine oil level is lower. Serious engine damage will occur.
- The low oil pressure-alert indicator does not indicate the engine oil level. Use the oil dipstick to check the remaining oil quantity. For further information, see page 40.

Instruments and indicators

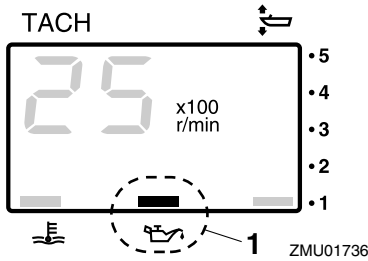

1. Low oil pressure-alert indicator

EMU26584

Overheat-alert indicator

If the engine temperature rises too high, the alert indicator will start to blink. For further information on reading the indicator, see page 34.

ECM00053

NOTICE

Do not continue to run the engine if the overheat-alert indicator is on. Serious engine damage will occur.

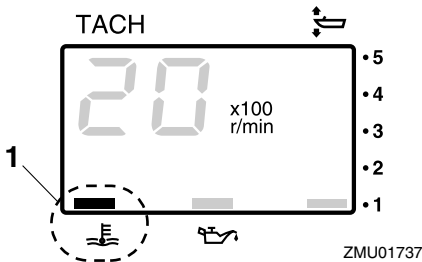

1. Overheat-alert indicator

EMU26603

Digital speedometer

This gauge shows the boat speed and other information.

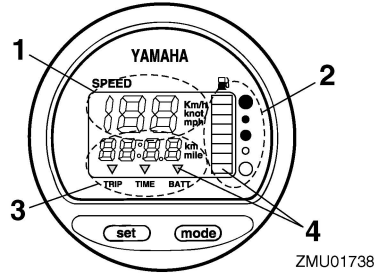

1. Speedometer
2. Fuel gauge
3. Trip meter/clock/voltmeter
4. Alert indicator(s)

All segments of the display will light momentarily after the main switch is turned on and will return to normal thereafter.

EMU36062

Speedometer

The speedometer displays km/h, mph, and knots, according to operator preference. Select the desired units of measurement by setting the selector switch on the back of the gauge. See the illustration for settings.

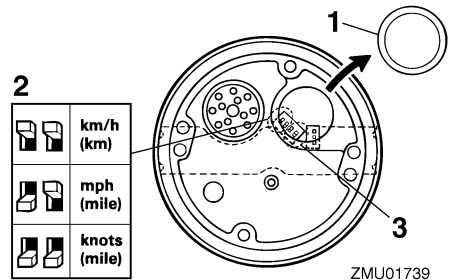

1. Cap
2. Selector switch (for speed unit)
3. Selector switch (for fuel sensor)

EMU26714

Fuel gauge

Eight segments indicate the fuel level. When

Instruments and indicators

all segments are showing, the fuel tank is full.

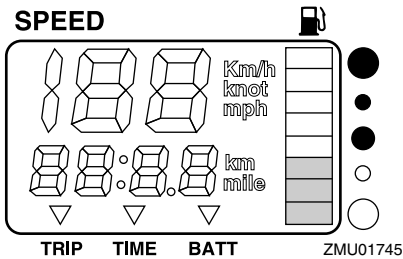

The fuel level reading can be inaccurate due to the position of the sensor in the fuel tank and the attitude of the boat in the water. Operation with bow-up trim or continuous turning can give false readings.

Do not adjust the selector switch for fuel sensor. Incorrectly setting the selector switch on the gauge will give false readings. Consult your Yamaha dealer on how to correctly set the selector switch. **NOTICE: Running out of fuel can damage the engine.** [ECM01771]

EMU36072

Trip meter / Clock / Voltmeter

The display shows either the trip meter, the clock, or the voltmeter.

To change the display, press the "mode" (mode) button repeatedly until the indicator on the face of the gauge points to "TRIP" (trip meter), "TIME" (clock), or "BATT" (voltmeter).

EMU26692

Trip meter

This gauge displays the distance the boat has traveled since the gauge was last reset. The trip distance is shown in kilometers or miles depending upon the unit of measurement selected for the speedometer.

To reset the trip meter to zero, press the "set" (set) and "mode" (mode) buttons at the same time.

The trip distance is kept in memory by bat-

tery power. The stored data will be lost if the battery is disconnected.

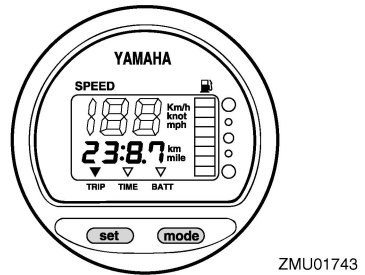

EMU26702

Clock

To set the clock:

1. Be sure the gauge is in the "TIME" (time) mode.
2. Press the "set" (set) button; the hour display will begin blinking.
3. Press the "mode" (mode) button until the desired hour is displayed.
4. Press the "set" (set) button again, the minute display will begin blinking.
5. Press the "mode" (mode) button until the desired minute is displayed.
6. Press the "set" (set) button again to start the clock.

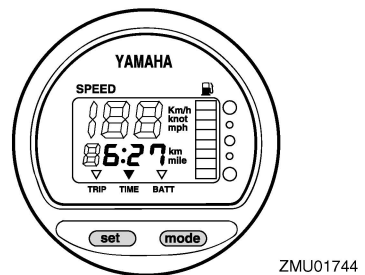

The clock operates on battery power. Disconnecting the battery will stop the clock. Reset the clock after connecting the battery.

Instruments and indicators

EMU36081

Voltmeter

The voltmeter displays the charge of the battery in volts(V).

EMU26723

Fuel level-alert indicator

If the fuel level decreases to one segment, the fuel level alert segment will blink.

Do not continue to operate the engine at full throttle if an alert device has activated. Get back to the port using trolling engine speed.

NOTICE: Running out of fuel can damage the engine. [ECM01771]

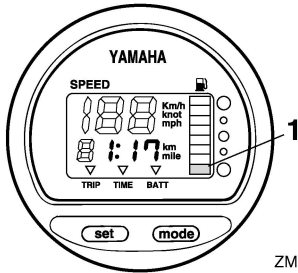

ZMU01746

1. Fuel level-alert segment

EMU26733

Low battery voltage-alert indicator

If battery voltage drops, the display will automatically turn on and blink.

Get back to the port soon if an alert device has activated. For charging the battery, consult your Yamaha dealer.

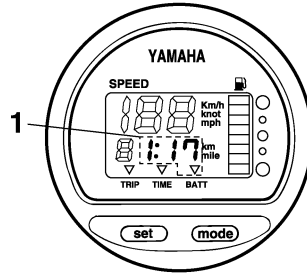

ZMU01747

1. Low battery indicator

EMU46810

6Y8 Multifunction meters

There are two types of 6Y8 Multifunction meters.

- 6Y8 Multifunction tachometer
- 6Y8 Multifunction speed & fuel meter

6Y8 Multifunction tachometer

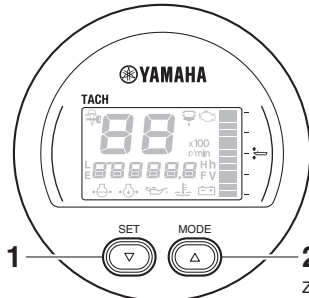

ZMU08407

1. Set button
2. Mode button

Instruments and indicators

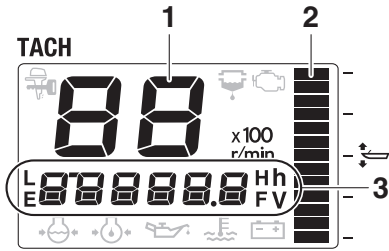

ZMU08408

1. Tachometer
2. Trim meter
3. Multifunction display

6Y8 Multifunction speed & fuel meter

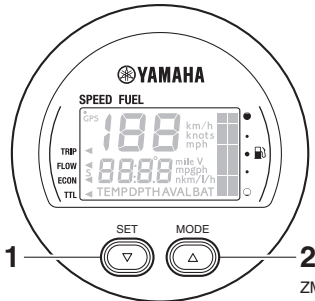

ZMU08409

1. Set button
2. Mode button

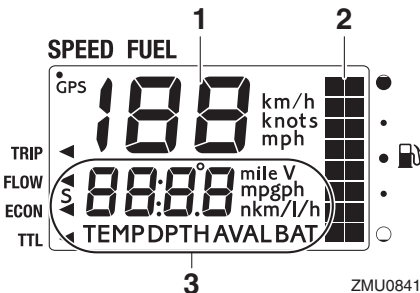

ZMU08410

1. Speedometer
2. Fuel meter
3. Multifunction display

TIP:

The information displayed on the multifunction display can be changed. For information on other settings or changing the displayed information, see the operation manual included with the 6Y8 Multifunction meter.

This manual mainly covers the alert display of the 6Y8 Multifunction tachometer. See the following sections for information about the alert indicators.

Indicators

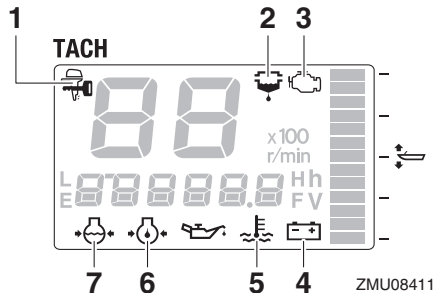

ZMU08411

1. Yamaha Security System indicator (optional)
2. Water separator-alert indicator
3. Engine trouble-alert indicator
4. Battery voltage indicator
5. Overheat-alert indicator
6. Low oil pressure-alert indicator
7. Cooling water pressure indicator (optional)

Yamaha Security System indicator (optional)

This indicator appears, when the Yamaha Security System is in lock mode.

Instruments and indicators

Lock mode

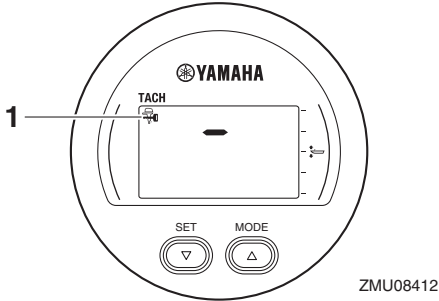

1. Yamaha Security System indicator (optional)

Make sure that the Yamaha Security System indicator is off before starting the engine.

Water separator-alert indicator

If water has accumulated in the water separator (fuel filter) while cruising, the water separator-alert indicator will start to blink.

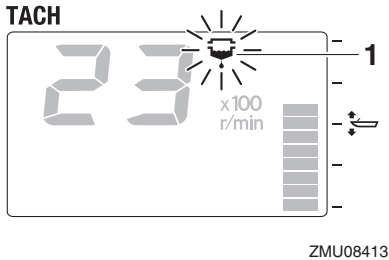

1. Water separator-alert indicator

Stop the engine immediately and see page 84 of this manual to drain the water from the fuel filter. Get back to the port soon and consult a Yamaha dealer immediately.

ECM00911

NOTICE

Gasoline mixed with water could cause damage to the engine.

Engine trouble-alert indicator

If the engine malfunctions while cruising, the

engine trouble-alert indicator will start to blink. Get back to the port soon and consult a Yamaha dealer immediately.

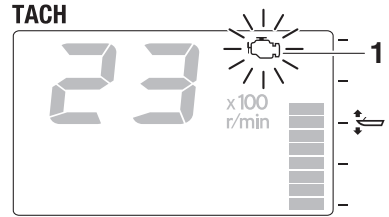

1. Engine trouble-alert indicator

ECM00921

NOTICE

In such an event, the engine will not operate properly. Consult a Yamaha dealer immediately.

Low battery voltage alert

If the battery voltage drops, the battery voltage value will start to blink.

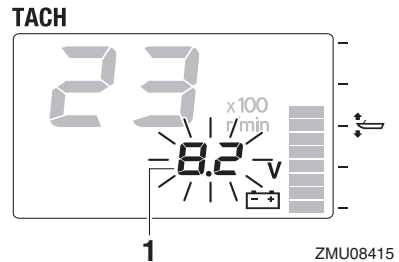

1. Battery voltage value

Get back to the port soon if the low battery voltage alert device has activated. For charging the battery, consult your Yamaha dealer.

Overheat-alert indicator

If the engine temperature rises too high while cruising, the overheat-alert indicator will start

Instruments and indicators

to blink, and the engine speed will automatically decrease to about 3000 r/min.

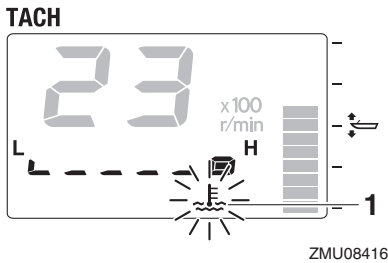

1. Overheat-alert indicator

Stop the engine immediately if the buzzer sounds and the overheat device has activated. Check the cooling water inlet for clogging.

ECM01594

NOTICE

- Do not continue to run the engine if the overheat-alert indicator blinks. Serious engine damage will occur.
- Do not continue to operate the engine if an alert device has activated. Consult your Yamaha dealer if the problem cannot be located and corrected.

Low oil pressure-alert indicator

If the engine oil pressure drops too low, the low oil pressure-alert indicator will start to blink, and the engine speed will automatically decrease to about 3000 r/min.

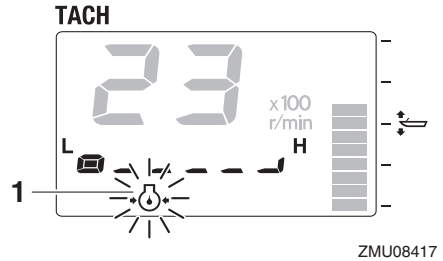

1. Low oil pressure-alert indicator

Stop the engine immediately if the buzzer sounds and the low oil pressure-alert indicator blinks. Check the engine oil quantity and replenish oil if necessary. If the alert device has activated while the appropriate engine oil quantity is maintained, consult your Yamaha dealer.

ECM01602

NOTICE

Do not continue to run the engine if the low oil pressure alert device has activated. Serious engine damage will occur.

Engine control system

EMU26805

Alert system

ECM00093

NOTICE

Do not continue to operate the engine if an alert device has activated. Consult your Yamaha dealer if the problem cannot be located and corrected.

EMU26839

Overheat alert

This engine has an overheat-alert device. If the engine temperature rises too high, the alert device will activate.

- The engine speed will automatically decrease to about 3000 r/min.
- The overheat-alert indicator will light or blink (if equipped).

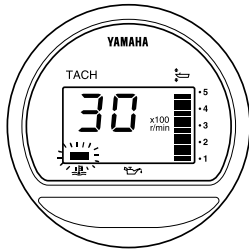

ZMU04227

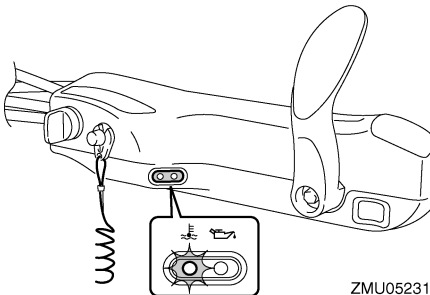

ZMU05231

- The buzzer will sound.

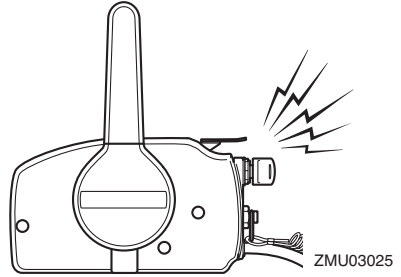

ZMU03025

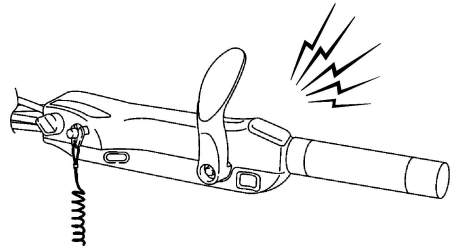

ZMU05326

If the alert system has activated, stop the engine and check the cooling water inlets:

- Check trim angle to be sure that the cooling water inlet is submerged.
- Check the cooling water inlet for clogging.

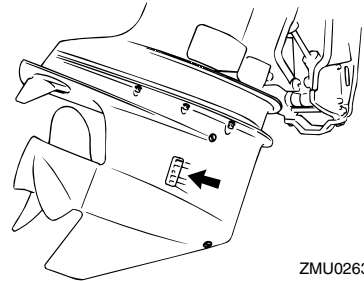

ZMU02630

EMU26866

Low oil pressure alert

If the oil pressure drops too low, the alert device will activate.

- The engine speed will automatically decrease to about 3000 r/min. The low oil

Engine control system

pressure-alert indicator will light or blink.

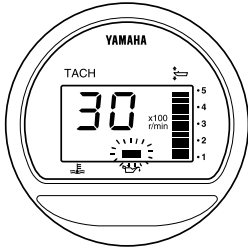

ZMU04254

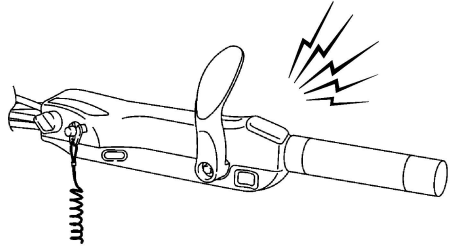

ZMU05326

If the alert system has activated, stop the engine as soon as it is safe to do so. Check the oil level and add oil as needed. If the oil level is correct, consult your Yamaha dealer.

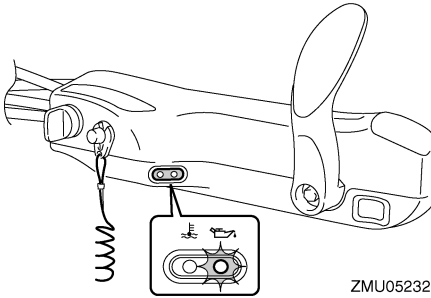

ZMU05232

- The buzzer will sound.

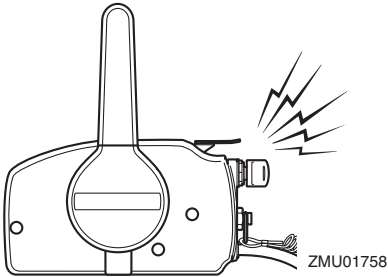

ZMU01758

Installation

EMU26903

Installation

The information presented in this section is intended as reference only. It is not possible to provide complete instructions for every possible boat and motor combination. Proper mounting depends in part on experience and the specific boat and motor combination.

EWMO1591

WARNING

- **Overpowering a boat could cause severe instability. Do not install an outboard motor with more horsepower than the maximum rating on the capacity plate of the boat. If the boat does not have a capacity plate, consult the boat manufacturer.**
- **Improper mounting of the outboard motor could result in hazardous conditions such as poor handling, loss of control, or fire hazards. For permanently mounted models, your dealer or other person experienced in proper rigging should mount the motor.**

EMU33471

Mounting the outboard motor

The outboard motor should be mounted so that the boat is well balanced. Otherwise, the boat could be hard to steer. For single-engine boats, mount the outboard motor on the centerline (keel line) of the boat.

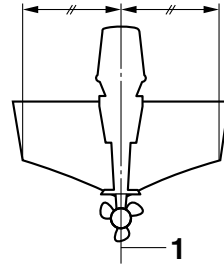

ZMU01760

1. Center line (keel line)

EMU26936

Mounting height (boat bottom)

The mounting height of your outboard motor affects its efficiency and reliability. If it is mounted too high, propeller ventilation may occur, which will reduce propulsion due to excessive propeller slip, and the water intakes for the cooling system may not get an adequate water supply, which can cause engine overheating. If the engine is mounted too low, water resistance (drag) will increase, thereby reducing engine efficiency and performance.

Most commonly, outboard motor should be mounted so that the anti-cavitation plate is in alignment with the bottom of the boat. The optimum mounting height of the outboard motor is affected by the boat/motor combination and the desired use. Test runs at different heights can help determine the optimum mounting height. Consult your Yamaha dealer or boat manufacturer for further information on determining the proper mounting height.

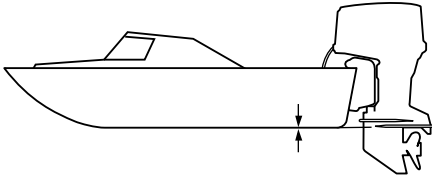

ZMU01762

ECM01635

NOTICE

- Make sure that the idle hole is high enough to prevent water from entering the engine even if the boat is stationary with the maximum load.
 - Incorrect engine height or obstructions to the smooth flow of water (such as the design or condition of the boat, or accessories, such as transom ladders or depth finder transducers) can create airborne water spray while the boat is cruising. If the outboard motor is operated continuously in the presence of airborne water spray, enough water could enter the engine through the air intake opening in the top cowling to cause severe engine damage. Remove the cause of the airborne water spray.
-

Operation

EMU36382

First-time operation

EMU36393

Fill engine oil

The engine is shipped from the factory without engine oil. If your dealer did not fill the oil, you must fill it before starting the engine.

NOTICE: Check that the engine is filled with oil before first-time operation to avoid severe engine damage. [ECM01782]

The engine is shipped with the following tag, which should be removed after engine oil is filled for the first time. For more information on checking the engine oil level, see page 40.

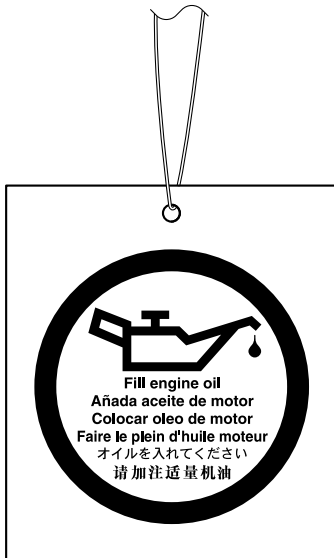

ZMU01710

EMU30175

Breaking in engine

Your new engine requires a period of break-in to allow mating surfaces of moving parts to wear in evenly. Correct break-in will help ensure proper performance and longer engine life. **NOTICE:** Failure to follow the break-in

procedure could result in reduced engine life or even severe engine damage. [ECM00802]

EMU27086

Procedure for 4-stroke models

Your new engine requires a period of 10 hours break-in to allow mating surfaces of moving parts to wear in evenly.

TIP:

Run the engine in the water, under load (in gear with a propeller installed) as follows. For 10 hours for breaking in engine avoid extended idling, rough water and crowded areas.

1. For the first hour of operation:
Run the engine at varying speeds up to 2000 r/min or approximately half throttle.
2. For the second hour of operation:
Increase engine speed as much as necessary to put the boat on plane (but avoid full-throttle operation), then back off on the throttle while keeping the boat at a planing speed.
3. Remaining 8 hours:
Run the engine at any speed. However, avoid operating at full throttle for more than 5 minutes at a time.
4. After the first 10 hours:
Operate the engine normally.

EMU36402

Getting to know your boat

All boats have unique handling characteristics. Operate cautiously while you learn how your boat handles under different conditions and various trim angles (see page 51).

EMU36414

Checks before starting engine

EWM01922



If any item in “Checks before starting engine” is not working properly, have it inspected and repaired before operating the outboard motor. Otherwise, an acci-

dent could occur.

ECM00121

NOTICE

Do not start the engine out of water. Overheating and serious engine damage can occur.

EMU36422

Fuel level

Be sure you have plenty of fuel for your trip. A good rule is to use 1/3 of your fuel to get to the destination, 1/3 to return, and to keep 1/3 as an emergency reserve. With the boat level on a trailer or in the water, turn the key to "ON" (on) and check the fuel level. For fuel filling instructions, see page 42.

EMU36573

Remove the top cowling

For the following checks, remove the top cowling from the bottom cowling. To remove the top cowling, release the cowling lock lever and lift off the top cowling.

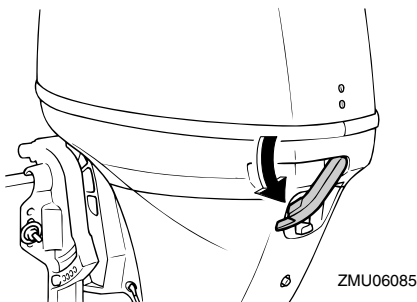

EMU36443

Fuel system

EWM00061

WARNING

Gasoline and its vapors are highly flammable and explosive. Keep away from sparks, cigarettes, flames, or other sources of ignition.

EWM00911

WARNING

Leaking fuel can result in fire or explosion.

- Check for fuel leakage regularly.
- If any fuel leakage is found, the fuel system must be repaired by a qualified mechanic. Improper repairs can make the outboard unsafe to operate.

EMU36453

Check for fuel leaks

- Check for fuel leaks or gasoline fumes in the boat.
- Check for fuel leakage from the fuel system.
- Check the fuel tank and fuel lines for cracks, swellings, or other damage.

EMU36472

Check the fuel filter

Check that the fuel filter is clean and free of water. If enough water to raise the float ring is found in the fuel, or if a significant amount of debris is found, the fuel tank should be checked and cleaned by a Yamaha dealer.

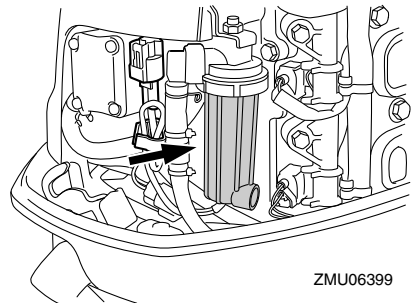

EMU36903

Controls

Tiller handle models:

- Move the tiller handle fully to the left and right to make sure operation is smooth.
- Turn the throttle grip from the fully closed to the fully open position. Make sure that it turns smoothly and that it completely re-

Operation

turns to the fully closed position.

- Look for loose or damaged connections of the throttle and shift cables.

Remote control models:

- Turn the steering wheel full-right and full-left. Make sure operation is smooth and unrestricted throughout the whole range with no binding or excessive free play.
- Operate the throttle levers several times to make sure there is no hesitation in their travel. Operation should be smooth over the complete range of motion, and each lever should return completely to the idle position.
- Look for loose or damaged connections of the throttle and shift cables.

EMU36484

Engine shut-off cord (lanyard)

Inspect the engine shut-off cord and clip for damage, such as cuts, breaks, and wear.

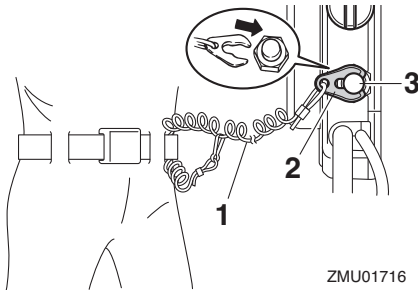

ZMU01716

1. Cord
2. Clip
3. Engine shut-off switch

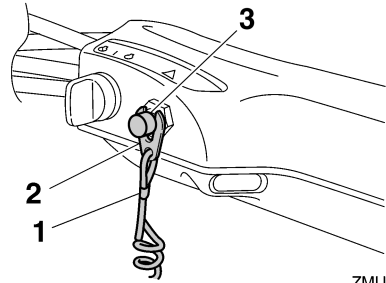

ZMU05208

1. Cord
2. Clip
3. Engine shut-off switch

EMU40994

Engine oil

1. Place the outboard motor in a vertical position (not tilted). **NOTICE: If the outboard motor is not level, the oil level indicated on the oil dipstick may not be accurate.** [ECM01862]
2. Remove the oil dipstick and wipe it clean.

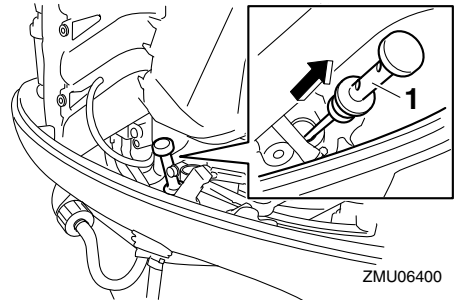

ZMU06400

1. Oil dipstick
3. Insert the oil dipstick completely and remove it again.
4. Check that the oil level on the oil dipstick is between the upper and lower marks. Consult your Yamaha dealer if the oil level is not at the proper level or if it ap-

pears milky or dirty.

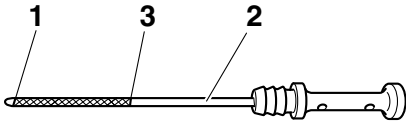

ZMU05091

1. Lower mark
2. Oil dipstick
3. Upper mark

EMU27154

Engine

- Check the engine and engine mounting.
- Look for loose or damaged fasteners.
- Check the propeller for damage.
- Check for engine oil leaks.

EMU36494

Flushing device

Check that the flushing device's garden hose connector is securely screwed on to the fitting on the bottom cowling. **NOTICE: If the garden hose connector is not properly connected, cooling water can leak out and the engine can overheat during operation.** [ECM01802]

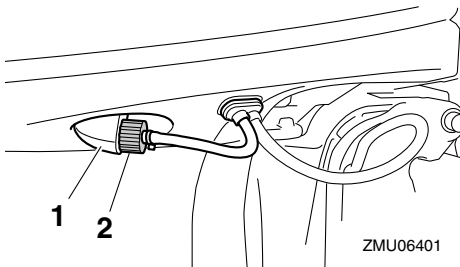

ZMU06401

1. Fitting

2. Flushing device

EMU36956

Install top cowling

1. Be sure that the cowling lock lever is released.
2. Be sure that the rubber seal is seated all the way around the top cowling.
3. Place the top cowling on the bottom cowling.
4. Check to be sure the rubber seal is seated correctly between the top cowling and the bottom cowling.
5. Move the cowling lock lever to lock the top cowling as shown. **NOTICE: If the top cowling is not installed correctly, water spray under the top cowling can damage the engine, or the top cowling can blow off at high speeds.**

[ECM01992]

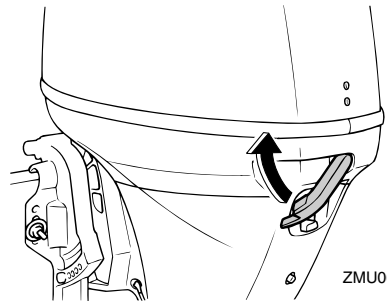

ZMU06110

After installing, check the fitting of the top cowling by pushing it with both hands. If the top cowling is loose, have it repaired by your Yamaha dealer.

Operation

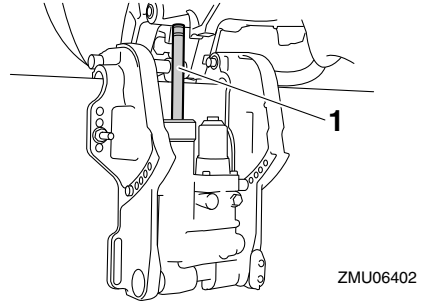
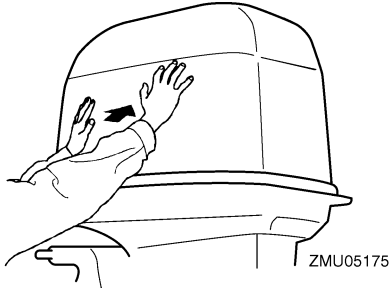

EMU38911

Checking power trim and tilt system

EWM01971

WARNING

- Never get under the lower unit while it is tilted, even when the tilt support knob is locked. Severe injury could occur if the outboard motor accidentally falls.
- Body parts can be crushed between the motor and the clamp bracket when the motor is trimmed or tilted.
- Be sure no one is near the outboard motor before performing this check.

1. Check the power trim and tilt unit for any sign of oil leaks.
2. Operate each of the power trim and tilt switches to check that all switches work.
3. Tilt the outboard motor up and check that the trim and tilt rod is pushed out completely.

1. Trim and tilt rod

4. Check that the trim and tilt rod is free of corrosion or other flaws.
5. Tilt the outboard motor down. Check that the trim and tilt rod operates smoothly.

EMU36585

Battery

Check the battery's charge. If your boat is equipped with a Yamaha digital speedometer, the voltmeter and low battery alert functions will help you monitor the battery's charge. A battery in good condition will provide a minimum of 12 volts. Check that the battery connections are clean, secure and covered by insulating covers. The electrical connections of the battery and cables must be clean and properly connected or the battery will not start the engine.

If the battery needs charging, consult your Yamaha dealer or the battery manufacturer's instructions.

EMU2743A

Filling fuel

EWM01831

WARNING

- Gasoline and its vapors are highly flammable and explosive. Always refuel according to this procedure to reduce the risk of fire and explosion.
- Gasoline is poisonous and can cause

injury or death. Handle gasoline with care. Never siphon gasoline by mouth. If you should swallow some gasoline or inhale a lot of gasoline vapor, or get some gasoline in your eyes, see your doctor immediately. If gasoline spills on your skin, wash with soap and water. If gasoline spills on your clothing, change your clothes.

1. Be sure the engine is stopped.
2. Disconnect the fuel line from the fuel tank and tighten the air vent screw on the fuel tank cap.

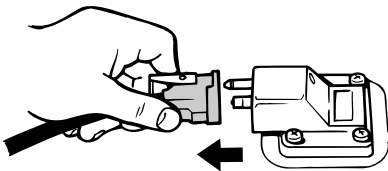

ZMU06598

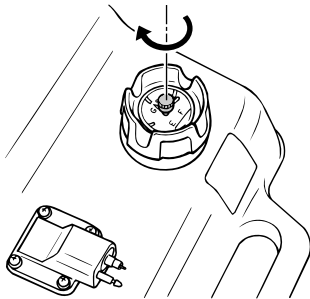

ZMU04058

3. Remove the portable tank from the boat.
4. Be sure you are in a well-ventilated outdoor area, either securely moored or trailered.
5. Do not smoke and keep away from sparks, flames, static electric discharge, or other sources of ignition.

6. If you use a portable container to store and dispense fuel, use only an approved GASOLINE container.
7. Touch the fuel nozzle to the filler opening or funnel to help prevent electrostatic sparks.
8. Fill the fuel tank, but do not overfill. **WARNING! Do not overfill. Otherwise fuel can expand and overflow if the temperature increases.** [EWM02611]

Fuel tank capacity:
25 L (6.60 US gal, 5.50 Imp.gal)

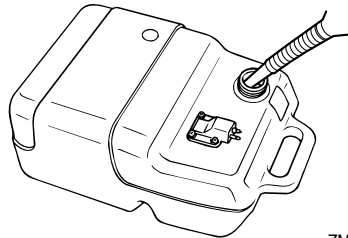

ZMU04047

9. Tighten the filler cap securely.
10. Wipe up any spilled gasoline immediately with dry rags. Dispose rags properly according to local laws or regulations.

EMU27453

Operating engine

EWM00421

WARNING

- Before starting the engine, make sure that the boat is tightly moored and that you can steer clear of any obstructions. Be sure there are no swimmers in the water near you.
- When the air vent screw is loosened, gasoline vapor will be released. Gasoline is highly flammable, and its vapors are flammable and explosive. Refrain from smoking, and keep away from

Operation

open flames and sparks while loosening the air vent screw.

- This product emits exhaust gases which contain carbon monoxide, a colorless, odorless gas which could cause brain damage or death when inhaled. Symptoms include nausea, dizziness, and drowsiness. Keep cockpit and cabin areas well ventilated. Avoid blocking exhaust outlets.

EMU2746A

Sending fuel (portable tank)

1. If there is an air vent screw on the fuel tank cap, loosen it 2 or 3 turns.

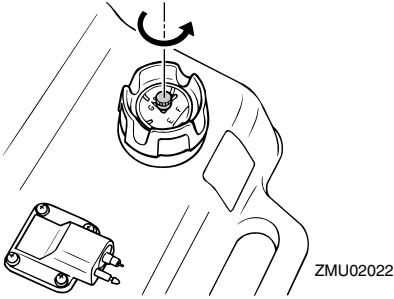

2. If there is a fuel joint on the motor, align the fuel joint on the fuel line with the fuel joint on the motor and firmly connect the fuel line to the joint while pinching the joint. Then firmly connect the other end of the fuel line to the joint on the fuel tank.

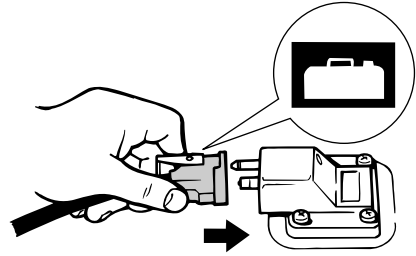
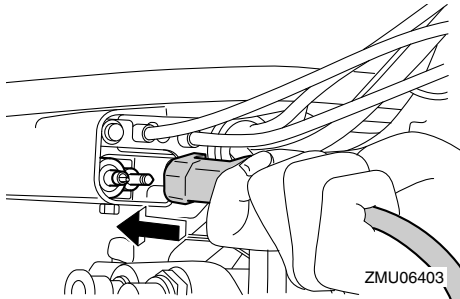

TIP:

Wipe up any spilled gasoline immediately with dry rags. Dispose rags properly according to local laws or regulations.

3. Squeeze the primer pump, with the arrow pointing up, until you feel it become firm. During engine operation place the tank horizontally, otherwise fuel cannot be drawn from the fuel tank.

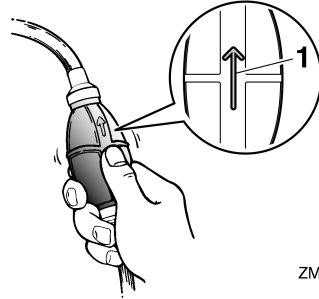

1. Arrow

EMU27495

Starting engine

EWM01601



Before starting the engine, make sure that the boat is tightly moored and that you can steer clear of any obstructions. Be sure there are no swimmers in the water near you.

EMU27597

Electric start / prime start models

EWM01842

WARNING

- Failure to attach the engine shut-off cord could result in a runaway boat if operator is ejected. Attach the engine shut-off cord to a secure place on your clothing, or your arm or leg while operating. Do not attach the cord to clothing that could tear loose. Do not route the cord where it could become entangled, preventing it from functioning.
- Avoid accidentally pulling the cord during normal operation. Loss of engine power means the loss of most steering control. Also, without engine power, the boat could slow rapidly. This could cause people and objects in the boat to be thrown forward.

1. Place the gear shift lever in neutral.

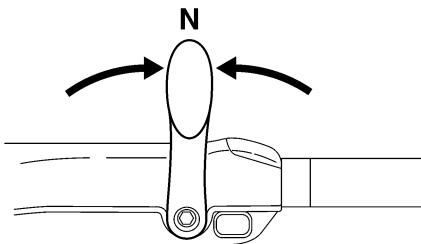

ZMU05215

TIP:

The start-in-gear protection device prevents the engine from starting except when in neutral.

2. Attach the engine shut-off cord to a secure place on your clothing, or your arm or leg. Then install the clip on the other end of the cord into the engine shut-off switch.

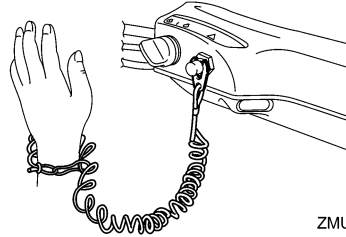

ZMU05216

3. Place the throttle grip in the “START” (start) position. After the engine starts, return the throttle to the fully closed position.

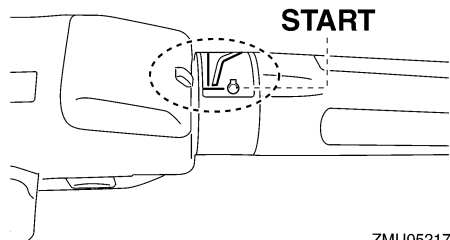

ZMU05217

4. Turn the main switch to “START” (start), and hold it for a maximum of 5 seconds.

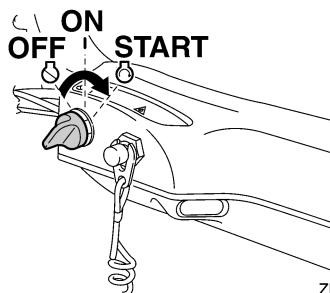

ZMU05218

5. Immediately after the engine starts, release the main switch and allow it to return to “ON” (on). **NOTICE: Never turn the main switch to “START” (start) while the engine is running. Do not**

Operation

keep the starter motor turning for more than 5 seconds. If the starter motor is turned continuously for more than 5 seconds, the battery will be quickly discharged, thus making it impossible to start the engine. The starter can also be damaged. If the engine will not start after 5 seconds of cranking, return the main switch to “ON” (on), wait 10 seconds, then crank the engine again. [ECM00193]

TIP:

- When the engine is cold, it needs to be warmed up. For further information, see page 47.
- If the engine is warm and fails to start, open the throttle slightly and try to start the engine again. If the engine still fails to start, see page 81.

EMUJ27666

Electric start and remote control models

EWM01842

WARNING

- Failure to attach the engine shut-off cord could result in a runaway boat if operator is ejected. Attach the engine shut-off cord to a secure place on your clothing, or your arm or leg while operating. Do not attach the cord to clothing that could tear loose. Do not route the cord where it could become entangled, preventing it from functioning.
- Avoid accidentally pulling the cord during normal operation. Loss of engine power means the loss of most steering control. Also, without engine power, the boat could slow rapidly. This could cause people and objects in the boat to be thrown forward.

1. Place the remote control lever in neutral.

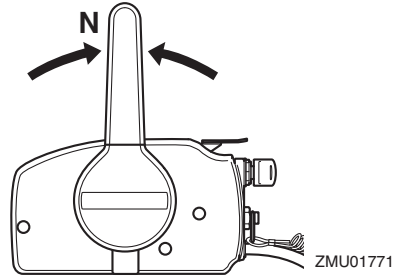

TIP:

The start-in-gear protection device prevents the engine from starting except when in neutral.

2. Attach the engine shut-off cord to a secure place on your clothing, or your arm or leg. Then install the clip on the other end of the cord into the engine shut-off switch.

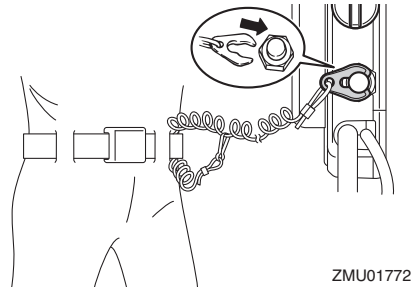

3. Turn the main switch to “ON” (on).
4. Turn the main switch to “START” (start), and hold it for a maximum of 5 seconds.

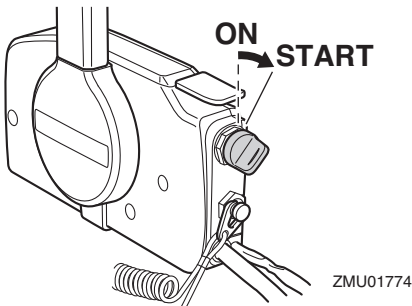

5. Immediately after the engine starts, release the main switch and allow it to return to “ON” (on). **NOTICE:** Never turn the main switch to “START” (start) while the engine is running. Do not keep the starter motor turning for more than 5 seconds. If the starter motor is turned continuously for more than 5 seconds, the battery will be quickly discharged, thus making it impossible to start the engine. The starter can also be damaged. If the engine will not start after 5 seconds of cranking, return the main switch to “ON” (on), wait 10 seconds, then crank the engine again. [ECM00193]

TIP:

- When the engine is cold, it needs to be warmed up. For further information, see page 47.
- If the engine is warm and fails to start, open the throttle slightly and try to start the engine again. If the engine still fails to start, see page 81.

EMU36511

Checks after starting engine

EMU36524

Cooling water

Check for a steady flow of water from the cooling water pilot hole. A continuous flow of water from the pilot hole indicates that the

water pump is pumping water through the cooling water passages. If the cooling water passages are frozen, it may take a while for water to start flowing out of the pilot hole.

ECM01811

NOTICE

If water is not flowing out of the pilot hole at all times while the engine is running, overheating and serious damage could occur. Stop the engine and check whether the cooling water inlet on the lower case or the cooling water pilot hole is blocked. Consult your Yamaha dealer if the problem cannot be located and corrected.

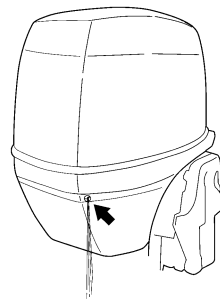

EMU27671

Warming up engine

EMU27718

Manual start and electric start models

1. After starting the engine, allow it to idle for 3 minutes to warm up. **NOTICE: Failure to do so will shorten engine life.**

[ECM04550]

2. Be sure the low oil pressure-alert indicator goes off after starting the engine. **NOTICE: If the low oil pressure-alert indicator blinks after the engine starts, stop the engine. Otherwise, serious engine damage could occur.**

Operation

Check the oil level and add engine oil if necessary. Consult your Yamaha dealer if the cause for the low oil pressure alert cannot be found.

[ECM01832]

EMU36532

Checks after engine warm up

EMU36542

Shifting

While the boat is tightly moored, and without applying throttle, confirm that the engine shifts smoothly into forward and reverse, and back to neutral.

EMU36981

Stop switches

- Turn the main switch to "OFF", or press the engine stop button and make sure the engine stops.
- Confirm that removing the clip from the engine shut-off switch stops the engine.
- Confirm that the engine cannot be started with the clip removed from the engine shut-off switch.

EMU34531

Shifting

EWM00181

WARNING

Before shifting, make sure there are no swimmers or obstacles in the water near you.

ECM01611

NOTICE

Warm up the engine before shifting into gear. Until the engine is warm, the idle speed may be higher than normal. High idle speed can prevent you from shifting back to neutral. If this occurs, stop the engine, shift to neutral, then restart the engine and allow it to warm up.

To shift out of neutral

1. Pull the neutral interlock trigger up (if

equipped).

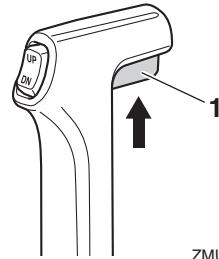

ZMU01727

1. Neutral interlock trigger
2. Move the remote control lever / gear shift lever firmly and crisply forward (for forward gear) or backward (for reverse gear) [about 35° (a detent can be felt) for remote control models]. Be sure to check that the tilt lock lever is in the lock/down position (if equipped) before operating in reverse.

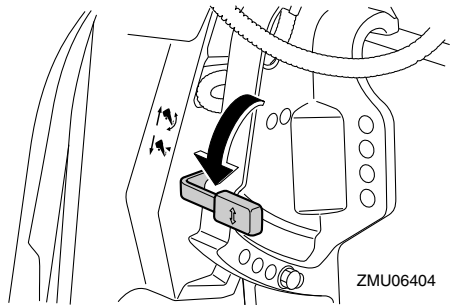

ZMU06404

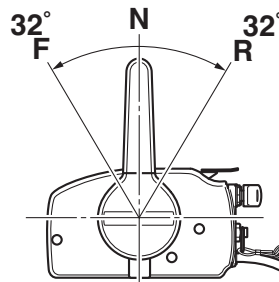

ZMU05460

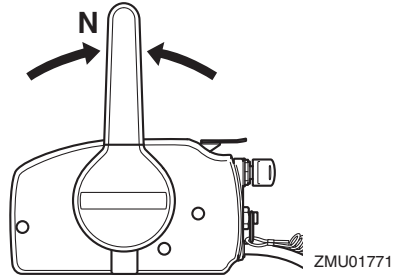
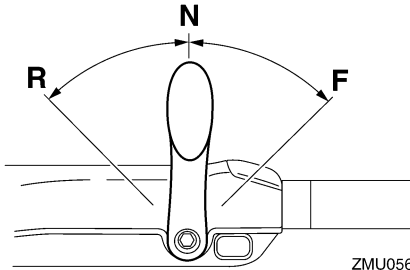

To shift from in gear (forward/reverse) to neutral

1. Close the throttle so that the engine slows to idle speed.

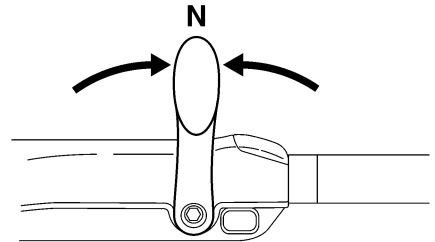
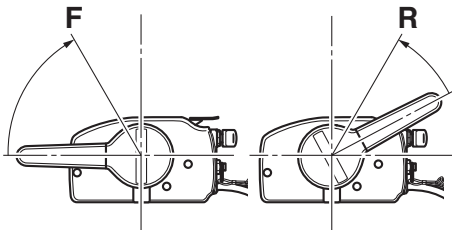

EMU31743

Stopping boat

EWM01511

⚠ WARNING

- Do not use the reverse function to slow down or stop the boat as it could cause you to lose control, be ejected, or impact the steering wheel or other parts of the boat. This could increase the risk of serious injury. It could also damage the shift mechanism.
- Do not shift into reverse while traveling at planing speeds. Loss of control, boat swamping, or damage to the boat could occur.

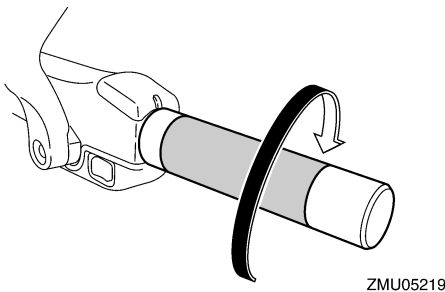

2. After the engine is at idle speed in gear move the remote control lever / gear shift lever firmly and crisply into the neutral position.

The boat is not equipped with a separate braking system. Water resistance stops it after the throttle lever is moved back to idle. The stopping distance varies depending on gross weight, water surface conditions, and wind direction.

Operation

EMU30881

Trolling

EMU30891

Adjusting trolling speed

The trolling speed on outboard motors equipped with the variable trolling RPM switches can be adjusted approximately 50 r/min with each press of a switch.

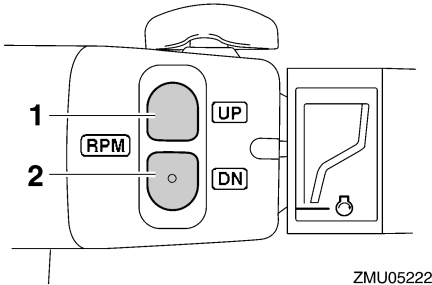

ZMU05222

1. "UP" switch
2. "DN" switch

To increase the trolling speed, press the "UP" switch.

To decrease the trolling speed, press the "DN" switch.

TIP:

- The trolling speed changes approximately 50 r/min each time a switch is pressed.
- If the trolling speed has been adjusted, the engine returns to the normal trolling speed when the engine is stopped and restarted or when the engine speed exceeds approximately 3000 r/min.

EMU27822

Stopping engine

Before stopping the engine, first let it cool off for a few minutes at idle or low speed. Stopping the engine immediately after operating at high speed is not recommended.

EMU27848

Procedure

1. Push and hold the engine stop button or

turn the main switch to "OFF" (off).

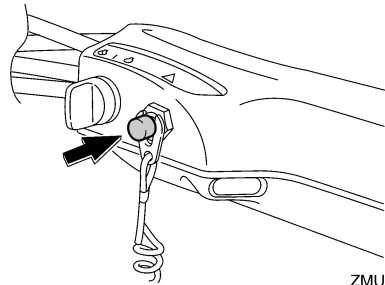

ZMU05209

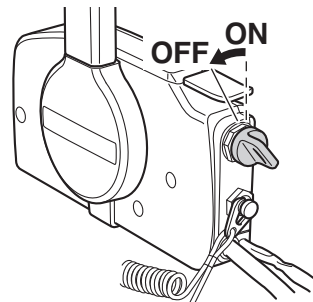

ZMU01779

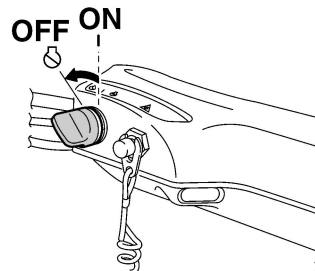

ZMU05223

2. After stopping the engine, disconnect the fuel line if there is a fuel joint on the outboard motor.

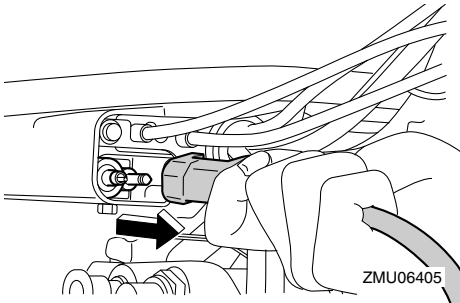

3. Tighten the air vent screw on the fuel tank cap (if equipped).

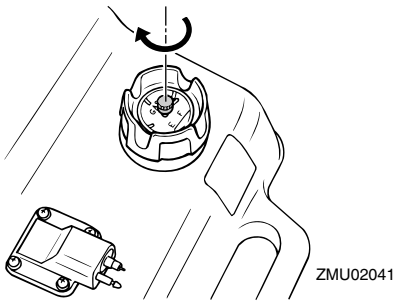

4. Remove the key if the boat will be left unattended.

TIP:

The engine can also be stopped by pulling the cord and removing the clip from the engine shut-off switch, then turning the main switch to "OFF" (off).

EMU27865

Trimming outboard motor

EWM00741

WARNING

Excessive trim for the operating conditions (either trim up or trim down) can cause boat instability and can make steering the boat more difficult. This increases the possibility of an accident. If the boat begins to feel unstable or is hard to steer, slow down and/or readjust the

trim angle.

The trim angle of the outboard motor helps determine the position of the bow of the boat in the water. Correct trim angle will help improve performance and fuel economy while reducing strain on the engine. Correct trim angle depends upon the combination of boat, engine, and propeller. Correct trim is also affected by variables such as the load in the boat, sea conditions, and running speed.

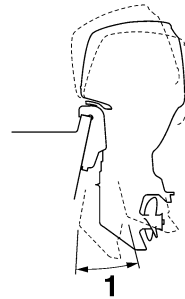

ZMU05170

1. Trim operating angle

EMU27889

Adjusting trim angle (Power trim and tilt)

EWM00754

WARNING

- Be sure all people are clear of the outboard motor when adjusting the trim angle. Body parts can be crushed between the motor and the clamp bracket when the motor is trimmed or tilted.
- Use caution when trying a trim position for the first time. Increase speed gradually and watch for any signs of instability or control problems. Improper trim angle can cause loss of control.
- If equipped with a power trim and tilt switch located on the bottom cowling, use the switch only when the boat is at

Operation

a complete stop with the engine off. Do not adjust the trim angle with this switch while the boat is moving.

Adjust the outboard motor trim angle using the power trim and tilt switch.

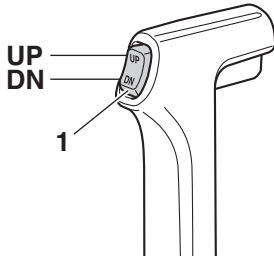

ZMU01781

1. Power trim and tilt switch

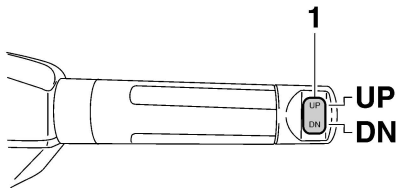

ZMU05224

1. Power trim and tilt switch

To raise the bow (trim-out), press the switch “UP” (up).

To lower the bow (trim-in), press the switch “DN” (down).

Make test runs with the trim set to different angles to find the position that works best for your boat and operating conditions.

EMU27893

Adjusting trim angle for hydro tilt models

EWM00492

! WARNING

- Stop the engine before adjusting the trim angle.
- Be sure all people are clear of the outboard motor when adjusting the trim angle, also be careful not to pinch any body parts between the drive unit and clamp bracket.
- Use caution when trying a trim position for the first time. Increase speed gradually and watch for any signs of instability or control problems. Improper trim angle can cause loss of control.

1. Stop the engine.
2. Place the tilt lock lever in the release position.

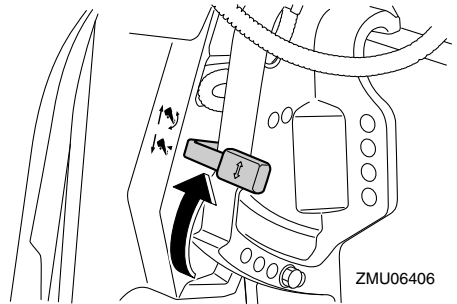

ZMU06406

3. Hold the rear of the top cowling with one hand and tilt the engine to the desired angle.
4. Place the tilt lock lever back into the lock position to support the engine.

To raise the bow (“trim-out”), tilt the engine up.

To lower the bow (“trim-in”), tilt the engine down.

Make test runs with the trim set to different angles to find the position that works best for

your boat and operating conditions.

EMU27913

Adjusting boat trim

When the boat is on plane, a bow-up attitude results in less drag, greater stability and efficiency. This is generally when the keel line of the boat is up about 3 to 5 degrees. With the bow up, the boat may have a greater tendency to steer to one side or the other. Compensate for this as you steer. When the bow of the boat is down, it is easier to accelerate from a standing start onto plane.

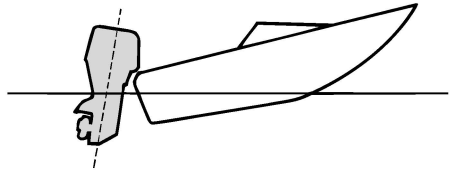

ZMU01785

Bow Down

Too much trim-in causes the boat to “plow” through the water, decreasing fuel economy and making it hard to increase speed. Operating with excessive trim-in at higher speeds also makes the boat unstable. Resistance at the bow is greatly increased, heightening the danger of “bow steering” and making operation difficult and dangerous.

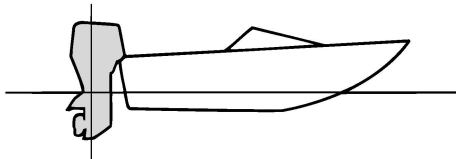

ZMU01784

Bow Up

Too much trim-out puts the bow of the boat too high in the water. Performance and economy are decreased because the hull of the boat is pushing the water and there is more air drag. Excessive trim-out can also cause the propeller to ventilate, which reduces performance further, and the boat may “porpoise” (hop in the water), which could throw the operator and passengers overboard.

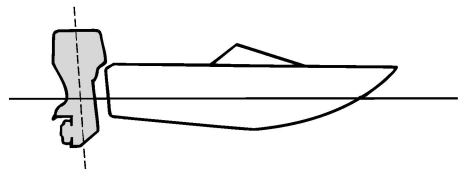

ZMU01786

TIP:

Depending on the type of boat, the outboard motor trim angle may have little effect on the trim of the boat when operating.

EMU27936

Tilting up and down

If the engine will be stopped for some time or if the boat is moored in shallows, the outboard motor should be tilted up to protect the propeller and lower casing from damage by collision with obstructions, and also to reduce salt corrosion.

Operation

EWM00223

WARNING

Make sure that no one is near the outboard motor when tilting the outboard motor up or down. Otherwise, body parts could be crushed between the outboard motor and the clamp bracket.

EWM00251

WARNING

Leaking fuel is a fire hazard. If there is a fuel joint on the outboard motor, disconnect the fuel line or close the fuel cock if the engine will be tilted for more than a few minutes. Otherwise fuel may leak.

ECM00242

NOTICE

- Before tilting the outboard motor, stop the engine by following the procedure on page 50. Never tilt the outboard motor while the engine is running. Severe damage from overheating can result.
- Do not tilt up the engine by pushing the tiller handle (if equipped) because this could break the handle.

EMU2799A

Procedure for tilting up (hydro tilt models)

1. Place the remote control lever / gear shift lever in neutral.

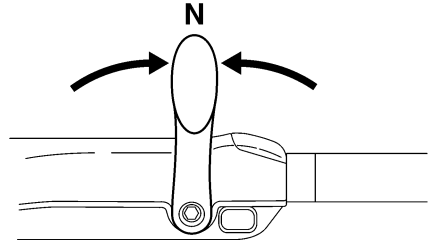
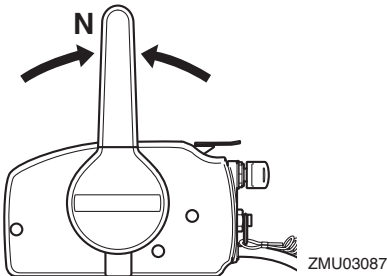

2. Place the tilt lock lever in the release position.

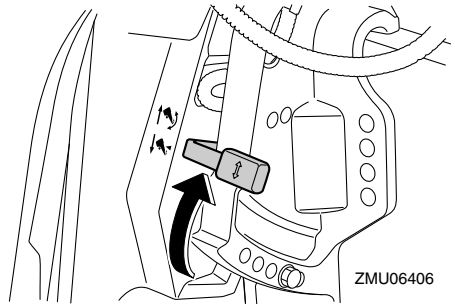

3. Hold the rear of the top cowling with one hand, tilt the engine up, and turn the tilt support lever toward you or tilt support knob into the clamp bracket, and then place the tilt lock lever back into the lock position to support the outboard motor. **NOTICE: Do not use the tilt support lever or knob when trailering the boat. The outboard motor could shake loose from the tilt support and fall. If the motor cannot be trailered in the normal running position, use an additional support device to secure it in the tilt position. For more detailed information, see page 60.** [ECM01642]

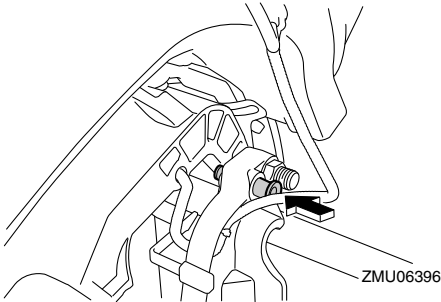

EMU44590

Procedure for tilting up (power trim and tilt models)

1. Place the remote control lever / gear shift lever in neutral.

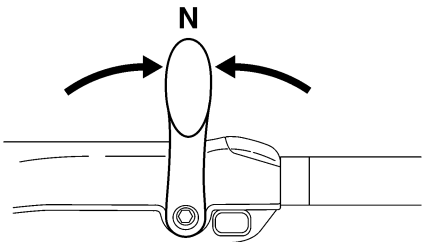
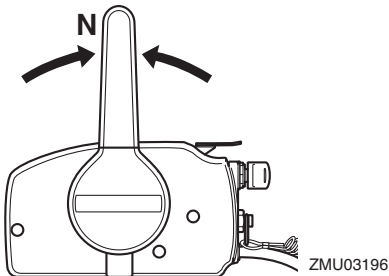

2. Press the power trim and tilt switch “UP” (up) until the outboard motor has tilted up completely.

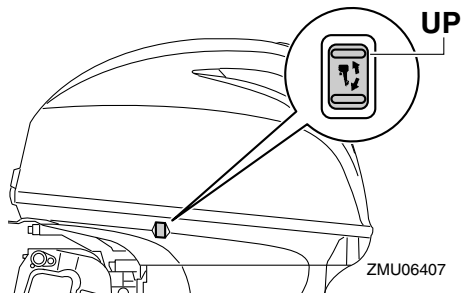
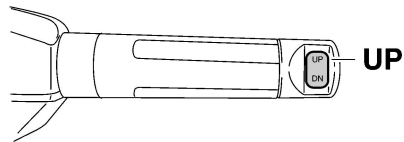
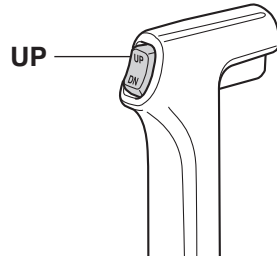

3. Push the tilt support knob into the clamp bracket to support the engine.
WARNING! After tilting the outboard motor, be sure to support it with the tilt support knob or tilt support lever. Otherwise the outboard motor could fall back down suddenly if oil in the power trim and tilt unit or in the power tilt unit loses pressure. [EWM00263]
NOTICE: Do not use the tilt support

Operation

lever or knob when trailering the boat. The outboard motor could shake loose from the tilt support and fall. If the motor cannot be trailered in the normal running position, use an additional support device to secure it in the tilt position. For more detailed information, see page 60. [ECM01642]

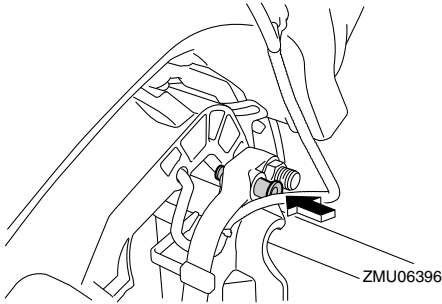

EMU34481

Procedure for tilting down (hydro tilt models)

1. Release the tilt lock lever.

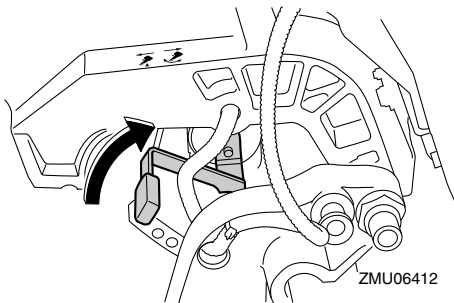

2. Hold the rear of the top cowling with one hand, tilt the outboard motor up slightly and pull out the tilt support knob or return the tilt support lever.

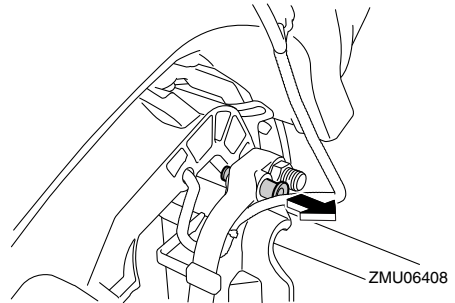

3. Slowly tilt the outboard motor down.
4. Place the tilt lock lever in the lock position.

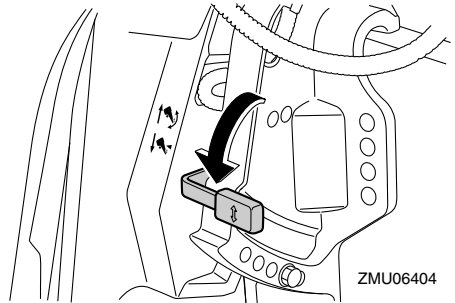

EMU44601

Procedure for tilting down (power trim and tilt models)

1. Push the power trim and tilt switch "UP" (up) until the outboard motor is supported by the tilt rod and the tilt support knob becomes free.
2. Pull out the tilt support knob.

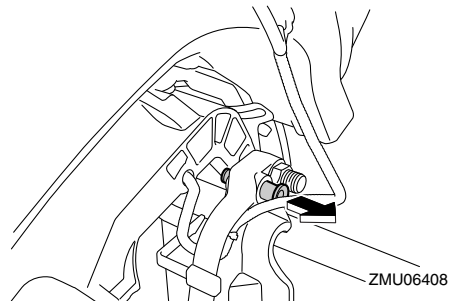

3. Push the power trim and tilt switch “DN” (down) to lower the outboard motor to the desired position.

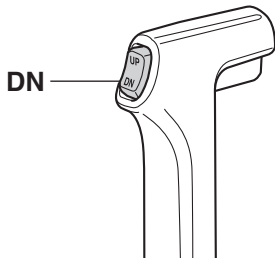

ZMU01936

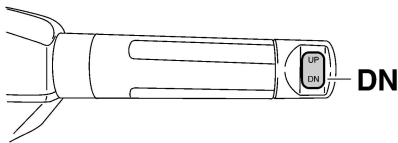

ZMU05228

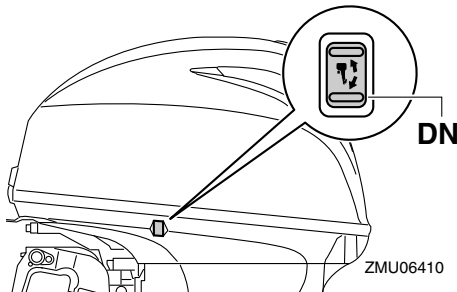

ZMU06410

EMU28063

Shallow water

EMU28082

Hydro tilt models

The outboard motor can be tilted up partially to allow operation in shallow water.

EWMO0272

WARNING

- Run the boat at the lowest possible speed when using the shallow water cruising system.
- Use extra care when operating in reverse. Too much reverse thrust can cause the outboard motor to lift out of the water, increasing the chance of accident and personal injury.

ECM00261

NOTICE

Do not tilt the outboard motor up so that the cooling water inlet on the lower unit is above the surface of the water when setting up for and cruising in shallow water. Otherwise severe damage from overheating can result.

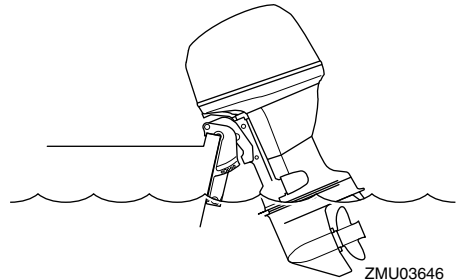

ZMU03646

EMU28176

Procedure for hydro tilt models

1. Place the remote control lever / gear shift lever in neutral.

Operation

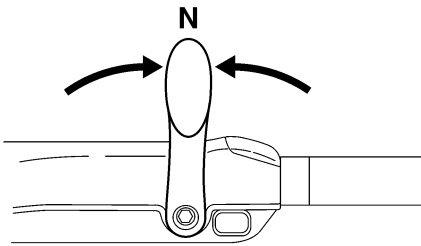
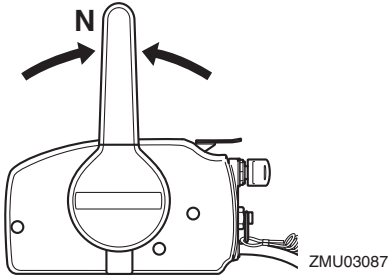

2. Pull the tilt lock lever up to the release position.

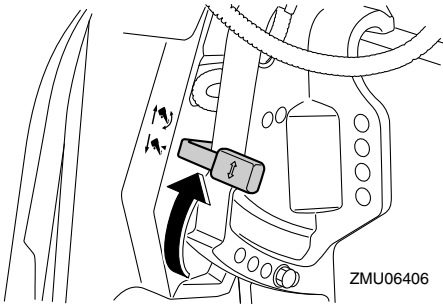

3. Slightly tilt the outboard motor up to the desired position and push the tilt lock lever down to the lock position.
4. To return the outboard motor to the normal running position, pull the tilt lock lever up to the release position and slowly tilt the outboard motor down.
5. Push the tilt lock lever down to the lock position.

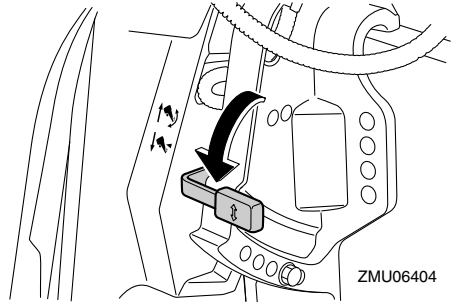

EMU32852

Power trim and tilt models

The outboard motor can be tilted up partially to allow operation in shallow water.

ECM00261

NOTICE

Do not tilt the outboard motor up so that the cooling water inlet on the lower unit is above the surface of the water when setting up for and cruising in shallow water. Otherwise severe damage from overheating can result.

EMU32914

Procedure for power trim and tilt models

1. Place the remote control lever / gear shift lever in neutral.

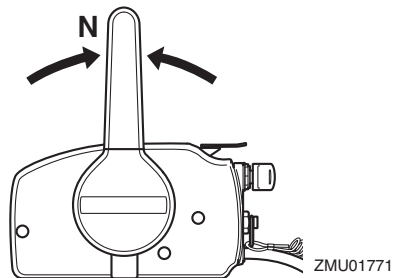

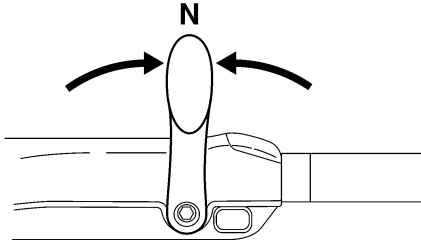

ZMU05215

2. Slightly tilt the outboard motor up to the desired position using the power trim and tilt switch. **WARNING! Using the power trim and tilt switch on the bottom cowling while the boat is moving or engine is on could increase the risk of falling overboard and could distract the operator, increasing the risk of collision with another boat or an obstacle.** [EWM01851]

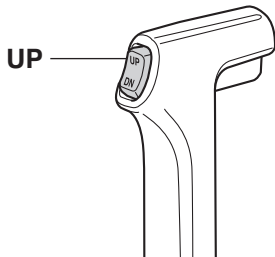

ZMU01935

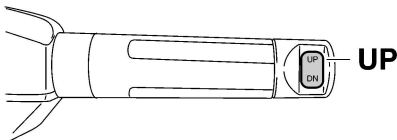

ZMU05226

3. To return the outboard motor to the nor-

mal running position, press the power trim and tilt switch and slowly tilt the outboard motor down.

EMU28196

Cruising in other conditions

Cruising in salt water

After operating in salt water, flush the cooling water passages with fresh water to prevent them from becoming clogged. Also rinse the outside of the outboard motor with fresh water.

Cruising in muddy, turbid, or acidic water

Yamaha strongly recommends that you use the optional chromium-plated water pump kit (see page 13) if you use the outboard motor in acidic water or water with a lot of sediment in it, such as muddy or turbid (cloudy) water. After operating in such water, flush the cooling passages with fresh water to prevent corrosion. Also rinse the outside of the outboard motor with fresh water.

Maintenance

EMU2822B

Transporting and storing outboard motor

EWM02621

WARNING

- **USE CARE** when transporting fuel tank, whether in a boat or car.
- **DO NOT** fill fuel container to maximum capacity. Gasoline will expand considerably as it warms up and can build up pressure in the fuel container. This can cause fuel leakage and a potential fire hazard.
- **Leaking fuel is a fire hazard. When transporting and storing the outboard motor, disconnect the fuel line from the outboard motor to prevent fuel from leaking.**
- **Never get under the outboard motor while it is tilted. Severe injury could occur if the outboard motor accidentally falls.**
- **Do not use the tilt support lever or knob when trailering the boat. The outboard motor could shake loose from the tilt support and fall. If the outboard motor cannot be trailered in the normal running position, use an additional support device to secure it in the tilt position.**

ECM02441

NOTICE

When storing the outboard motor for prolonged time, fuel must be drained from the fuel tank. The deteriorated fuel could clog the fuel line causing engine start difficulty or malfunction.

When storing or transporting the outboard motor, make sure to follow the procedure listed below.

- Disconnect the fuel line from the outboard motor.
- Tighten the fuel tank cap and its air vent screw.
- When the outboard motor is tilted prolonged time for mooring or trailering the boat, disconnect the fuel line from the outboard motor. Tighten the fuel tank cap and its air vent screw.

The outboard motor should be transported and stored in the normal running position. If there is insufficient road clearance in this position, then trailer the outboard motor in the tilt position using a motor support device such as a transom saver bar. Consult your Yamaha dealer for further details.

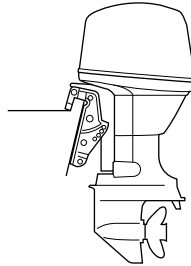

ZMU03659

EMU28292

Storing outboard motor

When storing your Yamaha outboard motor for prolonged periods of time (2 months or longer), several important procedures must be performed to prevent excessive damage. It is advisable to have your outboard motor serviced by an authorized Yamaha dealer prior to storage. However, you, the owner, with a minimum of tools, can perform the following procedures.

ECM00601

NOTICE

- **To prevent problems which can be caused by oil entering the cylinder from**

the sump, keep the outboard motor in the attitude shown when transporting and storing it. If storing or transporting the outboard motor on its side (not upright), put it on a cushion after draining the engine oil.

- Do not place the outboard motor on its side before the cooling water has drained from it completely, otherwise water may enter the cylinder through the exhaust port and cause engine trouble.
- Store the outboard motor in a dry, well-ventilated place, not in direct sunlight.
- Drain the remaining gasoline from the vapor separator. Gasoline left in the vapor separator for a prolonged period of time will break down and could cause damage to the fuel line.

EMU28306

Procedure

EMU28336

Flushing in a test tank

ECM00302

NOTICE

Before starting the engine, make sure to supply water to the cooling water passages. Otherwise, the engine could overheat and be damaged.

1. Wash the outboard motor body using fresh water. **NOTICE: Do not spray water into the air intake.** [ECM01841] For further information, see page 64.
2. Disconnect the fuel line from the motor or shut off the fuel cock, if equipped.
3. Remove the engine top cowl and silencer cover. Remove the propeller.
4. Install the outboard motor on the test tank. Fill the tank with fresh water to above the level of the anti-cavitation plate. **NOTICE: If the fresh water level**

is below the level of the anti-cavitation plate, or if the water supply is insufficient, engine seizure may occur.

[ECM00292]

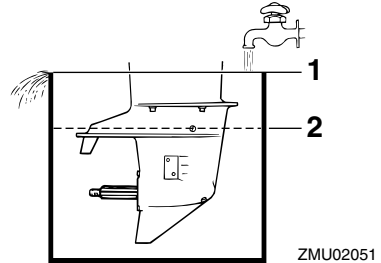

1. Water surface
2. Lowest water level
5. Cooling system flushing is essential to prevent the cooling system from clogging up with salt, sand, or dirt. In addition, fogging/lubricating of the engine is mandatory to prevent excessive engine damage due to rust. Perform the flushing and fogging at the same time. **WARNING! Do not touch or remove electrical parts when starting or during operation. Keep hands, hair, and clothes away from the flywheel and other rotating parts while the engine is running.** [EWM00092]
6. Run the engine at a fast idle for a few minutes in neutral position.
7. Just prior to turning off the engine, quickly spray "Fogging Oil" alternately into each carburetor or the fogging hole of the silencer cover, if equipped. When properly done, the engine will smoke excessively and almost stall.
8. Remove the outboard motor from the test tank.
9. Install the silencer cover/cap of fogging

Maintenance

hole and top cowling.

10. If the "Fogging Oil" is not available, run the engine at a fast idle until the fuel system becomes empty and the engine stops.
11. Drain the cooling water completely out of the motor. Clean the body thoroughly.
12. If the "Fogging Oil" is not available, remove the spark plug(s). Pour a teaspoonful of clean engine oil into each cylinder. Crank several times manually. Replace the spark plug(s).
13. Drain the fuel from the fuel tank.

TIP:

Store the fuel tank in a dry, well-ventilated place, not in direct sunlight.

EMU29957

Flushing with the flushing attachment

1. Wash the outboard motor body using fresh water. **NOTICE: Do not spray water into the air intake.** [ECM01841] For further information, see page 64.
2. Disconnect the fuel line from the motor or shut off the fuel cock, if equipped.
3. Remove the top cowling and propeller.
4. Install the flushing attachment over the cooling water inlet. **NOTICE: Do not run the engine without supplying it with cooling water. Either the engine water pump will be damaged or the engine will be damaged from overheating. Before starting the engine, be sure to supply water to the cooling water passages. Avoid running the outboard motor at high speed while on the flushing attachment, otherwise overheating could occur.** [ECM02001]

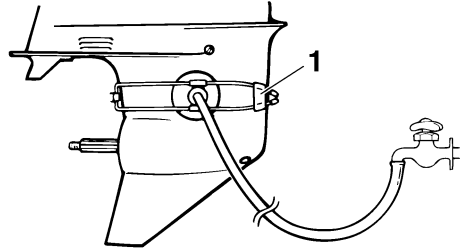

ZMU01830

1. Flushing attachment

5. Cooling system flushing is essential to prevent the cooling system from clogging up with salt, sand, or dirt. In addition, fogging/lubricating the engine is mandatory to prevent excessive engine damage due to rust. Perform the flushing and fogging at the same time. **WARNING! Do not touch or remove electrical parts when starting or during operation. Keep hands, hair, and clothes away from the flywheel and other rotating parts while the engine is running.** [EWM00092]

TIP:

- When using the flushing attachment, maintain adequate water pressure and a steady water flow.
 - If the overheat alert device is activated, turn the engine off, and consult your Yamaha dealer.
6. Run the engine at a fast idle for a few minutes in neutral position.
 7. Just prior to turning off the engine, quickly spray "Fogging Oil" alternately into the intake silencer or the fogging hole of the silencer cover, if equipped. When properly done, the engine will smoke excessively and almost stall.
 8. Drain the remained gasoline in the vapor

separator with a container. Loosen the drain screw, and then remove the cap. Push in the air valve with a screwdriver to introduce air into the float chamber, so that the gasoline will drain smoothly. Then, tighten the drain screw.

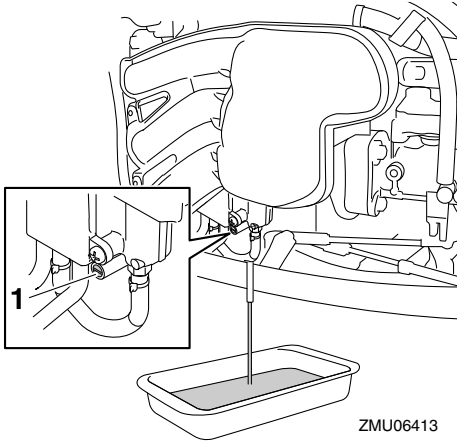

1. Drain screw

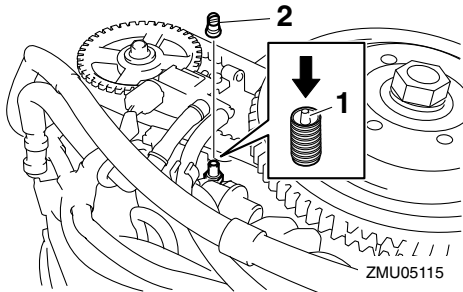

1. Air valve
 2. Cap
9. Remove the flushing attachment.
 10. Install the top cowling.
 11. If "Fogging Oil" is not available, turn off the engine after the 6 step. Then perform the 8 step procedure.

12. Drain the cooling water completely out of the motor. Clean the body thoroughly.
13. If the "Fogging Oil" is not available, remove the spark plug(s). Pour a teaspoonful of clean engine oil into each cylinder. Crank several times manually. Replace the spark plug(s).

TIP:

A flushing attachment is available from your Yamaha dealer.

EMU41072

Lubrication

1. Change the gear oil. For instructions, see page 76. Check the gear oil for the presence of water that indicates a leaky seal. Seal replacement should be performed by an authorized Yamaha dealer prior to use.
2. Lubricate all grease fittings. For further details, see page 69.

TIP:

For long-term storage, fogging the engine with fogging oil is recommended. Contact your Yamaha dealer for information about fogging oil and procedures for your outboard motor.

EMU28446

Flushing power unit

Perform this procedure right after operation for the most thorough flushing.

ECM01531

NOTICE

Do not perform this procedure while the engine is running. The water pump may be damaged and severe damage from overheating can result.

1. After shutting off the engine, unscrew the garden hose connector from the fitting on the bottom cowling.

Maintenance

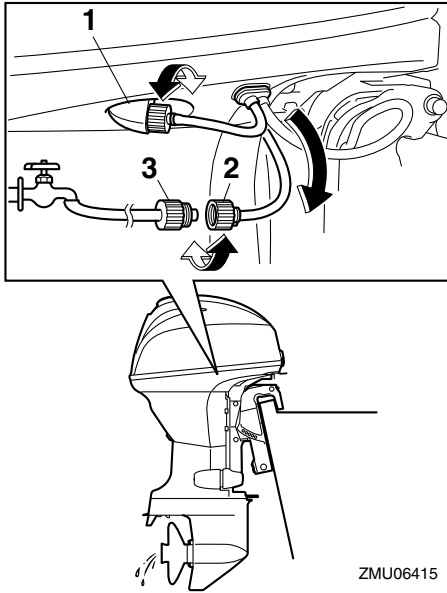

ZMU06415

1. Fitting
 2. Garden hose connector
 3. Garden hose adapter
2. Screw the garden hose adapter onto a garden hose, which is connected to a fresh water supply, and then connect it to the garden hose connector.
 3. With the engine off, turn on the water tap and let the water flush through the cooling passages for about 15 minutes. Turn off the water and disconnect the garden hose adapter from the garden hose connector.
 4. Reinstall the garden hose connector onto the fitting on the bottom cowling. Tighten the connector securely. **NOTICE: Do not leave the garden hose connector loose on the bottom cowling fitting or let the hose hang free during normal operation. Water**

will leak out of the connector instead of cooling the engine, which can cause serious overheating. Be sure the connector is tightened securely on the fitting after flushing the engine. [ECM00542]

TIP:

- When flushing the engine with the boat in the water, tilting up the outboard motor until it is completely out of the water will achieve better results.
- For cooling system flushing instructions, see page 60.

EMU44342

Cleaning the outboard motor

When cleaning the outboard motor, the top cowling must be installed.

1. Wash the exterior of the outboard motor using fresh water. **NOTICE: Do not spray water into the air intake.** [ECM01841]

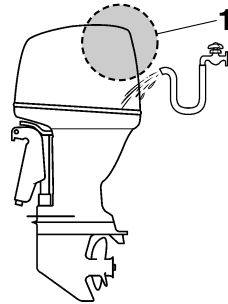

ZMU07861

1. Air intake
2. Drain the cooling water completely out of the outboard motor. Clean the body thoroughly.

EMU28463

Checking painted surface of outboard motor

Check the outboard motor for scratches, nicks, or flaking paint. Areas with damaged paint are more likely to corrode. If necessary,

clean and paint the areas. Touch-up paint is available from your Yamaha dealer.

EMU2847D

Periodic maintenance

EWM01872



These procedures require mechanical skills, tools, and supplies. If you do not have the proper skills, tools, or supplies to perform a maintenance procedure, have a Yamaha dealer or other qualified mechanic do the work.

The procedures involve disassembling the motor and exposing dangerous parts. To reduce the risk of injury from moving, hot, or electrical parts:

- **Turn off the engine and keep the key(s) and engine shut-off cord (lanyard) with you when you perform maintenance unless otherwise specified.**
- **The power trim and tilt switches operate even when the ignition key is off. Keep people away from the switches whenever working around the motor. When the motor is tilted, keep away from the area under it or between it and the clamp bracket. Be sure no one is in this area before operating the power trim and tilt mechanism.**
- **Allow the engine to cool before handling hot parts or fluids.**
- **Always completely reassemble the motor before operation.**

EMU28512

Replacement parts

If replacement parts are necessary, use only genuine Yamaha parts or parts of equivalent design and quality. Any part of inferior quality may malfunction, and the resulting loss of control could endanger the operator and passengers. Yamaha genuine parts and ac-

cessories are available from your Yamaha dealer.

EMU34152

Severe operating conditions

Severe operating conditions involve one or more of the following types of operation on a regular basis:

- Operating continuously at or near maximum engine speed (rpm) for many hours
- Operating continuously at a low engine speed (rpm) for many hours
- Operating without sufficient time for engine to warm up and cool down
- Frequent quick acceleration and deceleration
- Frequent shifting
- Frequently starting and stopping the engine(s)
- Operation that fluctuates often between light and heavy cargo loads

Outboard motors operating under any of these above conditions require more frequent maintenance. Yamaha recommends that you do this service twice as often as specified in the maintenance chart. For example, if a particular service should be done at 50 hours, do it instead at 25 hours. This will help prevent more rapid deterioration of engine components.

Maintenance

EMU46071

Maintenance chart 1

TIP:

- Refer to the sections in this chapter for explanations of each owner-specific action.
- The maintenance cycle on these charts assume usage of 100 hours per year and regular flushing of the cooling water passages. Maintenance frequency should be adjusted when operating the engine under adverse conditions such as extended trolling.
- Disassembly or repairs may be necessary depending on the outcome of maintenance checks.
- Expendable or consumable parts and lubricants will lose their effectiveness over time and through normal usage regardless of the warranty period.
- When operating in salt water, muddy, other turbid (cloudy), acidic water, the engine should be flushed with clean water after each use.

The “●” symbol indicates the check-ups which you may carry out yourself.

The “○” symbol indicates work to be carried out by your Yamaha dealer.

Item	Actions	Initial	Every			Page
		20 hours (3 months)	100 hours (1 year)	300 hours (3 years)	500 hours (5 years)	
Anode(s) (external)	Inspection or replacement as necessary		●/○			77
Anode(s) (internal) *1	Inspection or replacement as necessary		○			—
Anode(s) (internal) *2	Replacement				○	—
Battery (electrolyte level, terminal)	Inspection	●/○	●/○			78
Battery (electrolyte level, terminal)	Fill, charging or replacing as necessary		○			—
Cooling water leakage	Inspection or replacement as necessary	○	○			—
Cowling lock lever	Inspection		●/○			39, 41
Engine starting condition/noise	Inspection	●/○	●/○			43
Engine idle speed/noise	Inspection	●/○	●/○			71
Engine oil	Replacement	●/○	●/○			71
Engine oil filter (cartridge)	Replacement		●/○			—

Maintenance

Item	Actions	Initial	Every			Page
		20 hours (3 months)	100 hours (1 year)	300 hours (3 years)	500 hours (5 years)	
Fuel filter (can be disassembled)	Inspection or replacement as necessary	●/○	●/○			39
Fuel line (High pressure)	Inspection	●	●			—
Fuel line (High pressure)	Inspection or replacement as necessary	○	○			—
Fuel line (Low pressure)	Inspection	●	●			—
Fuel line (Low pressure)	Inspection or replacement as necessary	○	○			—
Fuel pump	Inspection or replacement as necessary			○		—
Fuel/engine oil leakage	Inspection	○	○			—
Gear oil	Replacement	●/○	●/○			76
Greasing points	Greasing	●/○	●/○			69
Clamp bracket bolt (through tube)	Inspection and greasing		○			—
Impeller/water pump housing	Inspection or replacement as necessary		○			—
Impeller/water pump housing	Replacement			○		—
Power trim and tilt unit	Inspection	●/○	●/○			42
Propeller/propeller nut/cotter pin	Inspection or replacement as necessary	●/○	●/○			74
Shift link/shift cable	Inspection, adjustment or replacement as necessary	○	○			—
Spark plug(s)	Inspection or replacement as necessary		●/○			70
Spark plug caps/spark plug wires	Inspection or replacement as necessary	○	○			—

Maintenance

Item	Actions	Initial	Every			Page
		20 hours (3 months)	100 hours (1 year)	300 hours (3 years)	500 hours (5 years)	
Water from the cooling water pilot hole	Inspection	●/○	●/○			47
Throttle link/throttle cable	Inspection, adjustment or replacement as necessary	○	○			—
Thermostat	Inspection or replacement as necessary		○			—
Timing belt	Inspection or replacement as necessary		○			—
Valve clearance	Inspection and adjustment				○	—
Cooling water inlet	Inspection	●/○	●/○			15
Main switch/stop switch	Inspection or replacement as necessary	○	○			—
Wire harness connections/wire coupler connections	Inspection or replacement as necessary	○	○			—
(Yamaha) Meter/gauge	Inspection	○	○			—
Fuel tank (Yamaha portable tank)	Inspection and cleaning as necessary		○			—

EMU46250

*1 cylinder head

*2 exhaust cover, exhaust guide

EMU46080

Maintenance chart 2

Item	Actions	Every	Page
		1000 hours	
Exhaust guide/exhaust manifold	Inspection or replacement as necessary	○	—
Timing belt	Replacement	○	—

EMU28945

Greasing

Yamaha grease A (water resistant grease)

Yamaha grease D (corrosion resistant grease; for propeller shaft)

F30BEHD, F40FEHD

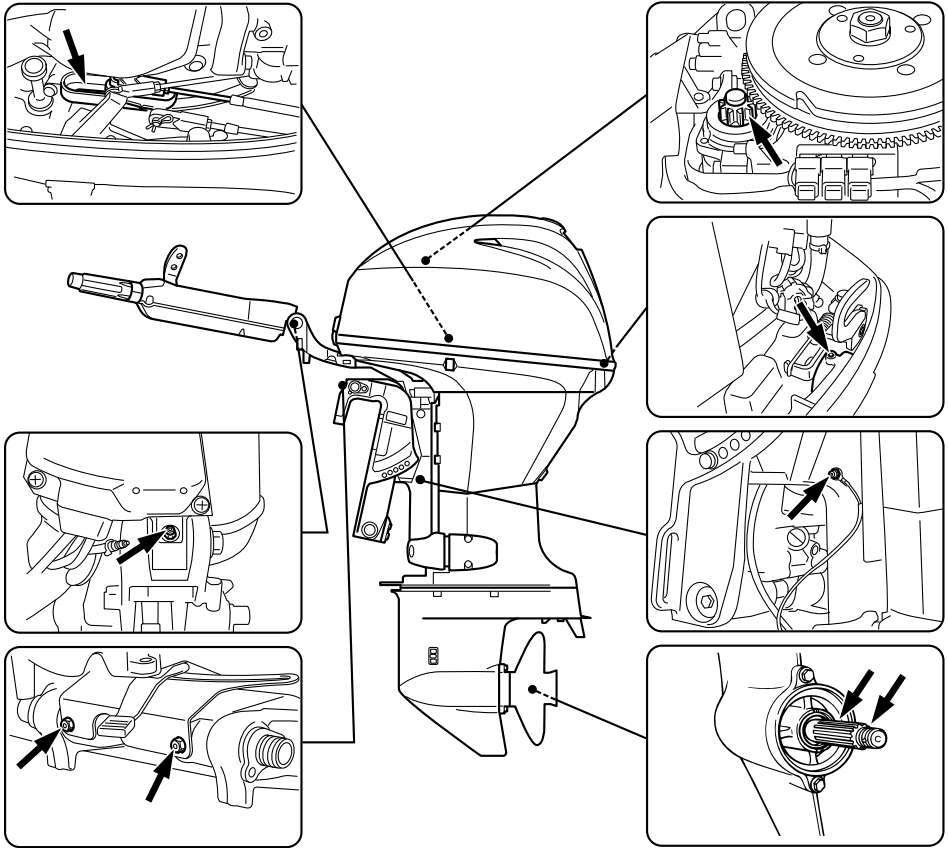

ZMU06417

Maintenance

F30BET, F40FED, F40FET

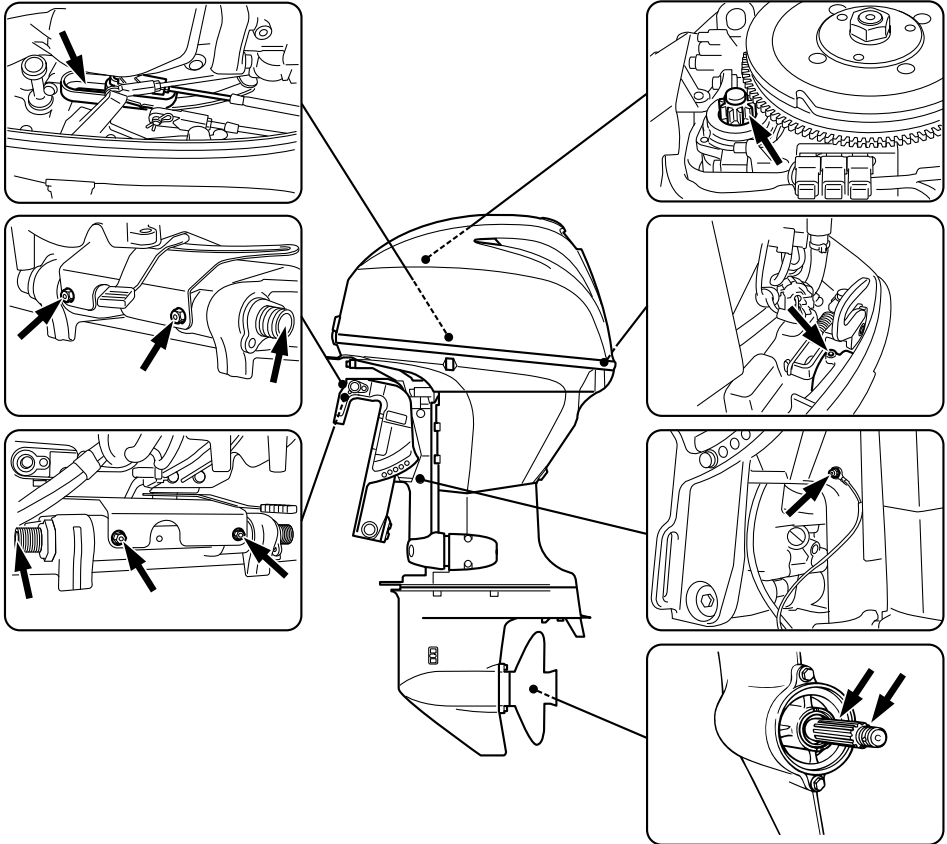

ZMU06416

EMU44850

Cleaning and adjusting spark plug

The spark plug is an important engine component and is easy to inspect. The condition of the spark plug can indicate something about the condition of the engine. For example, if the center electrode porcelain is very white, this could indicate an intake air leak or carburetion problem in that cylinder. Do not attempt to diagnose any problems yourself. Instead, take the outboard motor to a Yamaha dealer. You should periodically remove and inspect the spark plug because

heat and deposits will cause the spark plug to slowly break down and erode.

1. Remove the spark plug caps from the spark plugs.
2. Remove the spark plug. If electrode erosion becomes excessive, or if carbon and other deposits are excessive, you should replace the spark plug with another of the correct type. **WARNING!** When removing or installing a spark plug, be careful not to damage the insulator. A damaged insulator could

allow external sparks, which could lead to explosion or fire. [EWM00562]

Standard spark plug:
DPR6EB-9

3. Be sure to use the specified spark plug, otherwise the engine may not operate properly. Before fitting the spark plug, measure the electrode gap with a wire thickness gauge; replace it if out of specification.

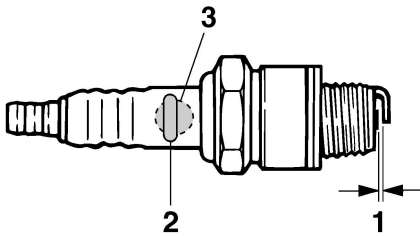

ZMU02179

1. Spark plug gap
2. Spark plug part number
3. Spark plug I.D. mark (NGK)

Spark plug gap:
0.8–0.9 mm (0.031–0.035 in)

4. When fitting the plug, wipe off any dirt from the threads, and then screw it in to the correct torque.

Spark plug torque:
17 Nm (1.73 kgf-m, 12.5 ft-lb)

TIP:

If a torque-wrench is not available when you are reinstalling a spark plug, a good estimate of the correct torque is 1/12 turn past finger-tight. When you are installing a new spark plug, a good estimate of the correct torque is 1/2 turn past finger-tight.

EMU29045

Inspecting idle speed

EWM00452

WARNING

- Do not touch or remove electrical parts when starting or during operation.
- Keep hands, hair, and clothes away from the flywheel and other rotating parts while the engine is running.

ECM00491

NOTICE

This procedure must be performed while the outboard motor is in the water. A flushing attachment or test tank can be used.

If the boat is not equipped with a tachometer for the outboard motor, use a diagnostic tachometer for this procedure. Results may vary depending on whether testing is conducted with the flushing attachment, in a test tank, or with the outboard motor in the water.

1. Start the engine and allow it to warm up fully in neutral until it is running smoothly.
2. Once the engine has warmed up, verify whether the idle speed is set to specification. For idle speed specifications, see page 9. If you have difficulty verifying the idle speed, or the idle speed requires adjustment, consult a Yamaha dealer or other qualified mechanic.

EMU38807

Changing engine oil

EWM00761

WARNING

- Avoid draining the engine oil immediately after stopping the engine. The oil is hot and should be handled with care to avoid burns.
- Be sure the outboard motor is securely fastened to the transom or a stable

Maintenance

stand.

ECM01711

NOTICE

Change the engine oil after the first 20 hours of operation or 3 months, and every 100 hours or at 1-year intervals thereafter. Otherwise the engine will wear quickly.

To prevent spilling oil where it could cause damage to nature, it is strongly recommended that you use an oil changer to change the engine oil. If an oil changer is not available, drain the engine oil by removing the drain screw. If you are not familiar with the procedure for changing the engine oil, consult your Yamaha dealer.

1. Put the outboard motor in an upright position (not tilted). **NOTICE: If the outboard motor is not level, the oil level indicated on the oil dipstick may not be accurate.** [ECM01862]

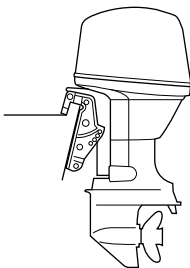

ZMU03659

2. Start the engine. Warm it up and keep the idle speed for 5-10 minutes.
3. Stop the engine and leave it for 5-10 minutes.
4. Remove the top cowling.
5. Remove the oil filler cap. Pull out the dipstick and use the oil changer to extract the oil completely.

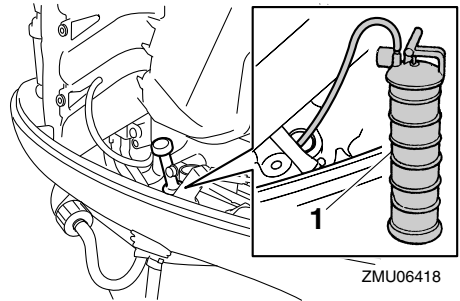

1. Oil changer

TIP:

When using an oil changer, skip steps 6 and 7.

6. Prepare a suitable container that holds a larger amount than the engine oil capacity. Remove the drain screw and gasket while holding the container under the drain hole. Let the oil drain completely. Wipe up any spilled oil immediately.

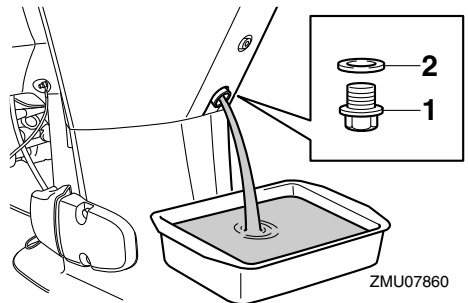

1. Drain screw
2. Gasket

TIP:

If the oil does not drain easily, change the tilt angle or turn the outboard motor to port and starboard to drain the oil.

7. Put a new gasket on the oil drain screw. Apply a light coat of oil to the gasket and install the drain screw.

Drain screw tightening torque:
27 Nm (2.75 kgf-m, 19.9 ft-lb)

TIP:

If a torque wrench is not available when you are installing the drain screw, finger tighten the screw just until the gasket comes into contact with the surface of the drain hole. Then tighten 1/4 to 1/2 turn more. Tighten the drain screw to the correct torque with a torque wrench as soon as possible.

8. Add the correct amount of oil through the filler hole. Put back the filler cap and the dipstick. **NOTICE: Overfilling the oil could cause leakage or damage. If the oil level is above the upper level mark, drain until the level meets the specified capacity.** [ECM01851]

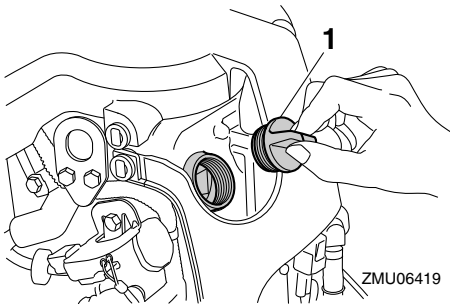

1. Oil filler cap

Recommended engine oil:

YAMALUBE 4 or 4-stroke outboard motor oil

Engine oil quantity (without oil filter replacement):

1.5 L (1.59 US qt, 1.32 Imp.qt)

Engine oil quantity (with oil filter replacement):

1.7 L (1.80 US qt, 1.50 Imp.qt)

9. Leave the outboard motor for 5-10 minutes.

10. Remove the oil dipstick and wipe it clean.
11. Insert the dipstick and remove it again. Be sure to completely insert the dipstick into the dipstick guide, otherwise the oil level measurement will be incorrect.
12. Recheck the oil level using the dipstick to be sure the level falls between the upper and lower marks. Consult your Yamaha dealer if the oil level is out of specified level.

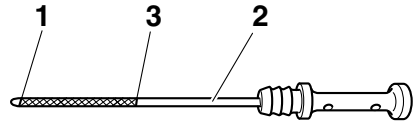

ZMU05091

1. Lower mark
2. Oil dipstick
3. Upper mark

13. Start the engine and make sure that the low oil pressure-alert indicator remains off. Also, make sure that there are no oil leaks. **NOTICE: If the low oil pressure-alert indicator comes on or if there are oil leaks, stop the engine and find the cause. Continued operation with a problem could cause severe engine damage. Consult your Yamaha dealer if the problem cannot be located and corrected.** [ECM01623]
14. Install the top cowling.
15. Dispose of used oil according to local regulations.

TIP:

- For more information on the disposal of

Maintenance

used oil, consult your Yamaha dealer.

- Change the oil more often when operating the engine under adverse conditions such as extended trolling.

EMU29116

Inspecting wiring and connectors

- Inspect that each connector is engaged securely.
- Inspect that each ground lead is properly secured.

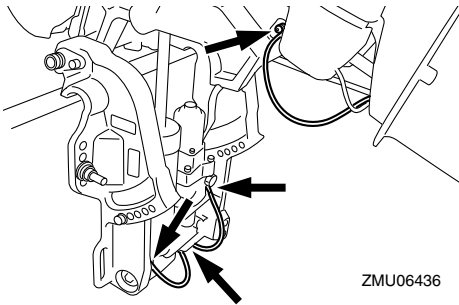
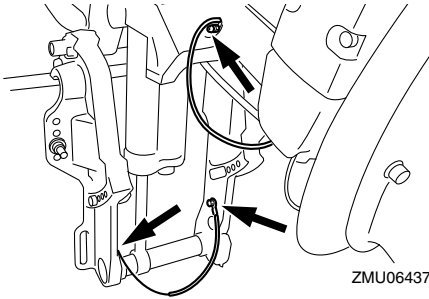

EMU32113

Checking propeller

EWM01882



You could be seriously injured if the engine accidentally starts when you are near the propeller. Before inspecting, removing, or installing the propeller, place the shift control in neutral, turn the main switch to “OFF” (off) and remove the key,

and remove the clip from the engine shut-off switch. Turn off the battery cut-off switch if your boat has one.

Do not use your hand to hold the propeller when loosening or tightening the propeller nut. Put a wood block between the anti-cavitation plate and the propeller to prevent the propeller from turning.

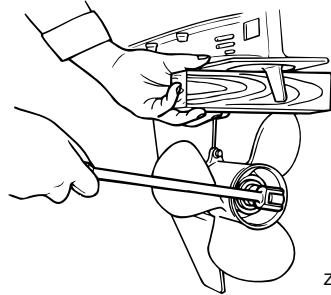

Checkpoints

- Check each of the propeller blades for erosion from cavitation or ventilation, or other damage.
- Check the propeller shaft for damage.
- Check the splines for wear or damage.
- Check for fish line tangled around the propeller shaft.

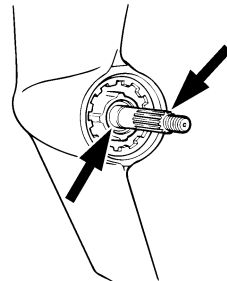

- Check the propeller shaft oil seal for damage.

EMU30663

Removing propeller

EMU29198

Spline models

1. Straighten the cotter pin and pull it out using a pair of pliers.
2. Remove the propeller nut, washer, and spacer (if equipped). **WARNING! Do not use your hand to hold the propeller when loosening the propeller nut.**

[EWM01891]

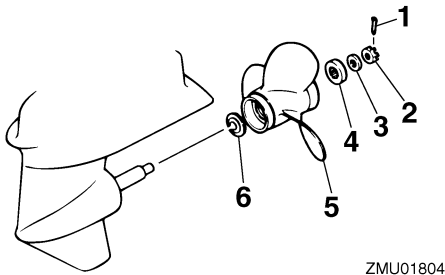

ZMU01804

1. Cotter pin
2. Propeller nut
3. Washer
4. Spacer
5. Propeller
6. Thrust washer

3. Remove the propeller, washer (if equipped), and thrust washer.

EMU30673

Installing propeller

EMU46120

Spline models

ECM00502

NOTICE

Make sure to use a new cotter pin and bend the ends over securely. Otherwise, the propeller could come off during operation and be lost.

1. Apply Yamalube Marine Grease or a corrosion resistant grease to the propeller shaft.

ler shaft.

2. Install the spacer (if equipped), thrust washer, washer (if equipped), and propeller on the propeller shaft. **NOTICE: Make sure to install the thrust washer before installing the propeller. Otherwise, the lower case and propeller boss could be damaged.** [ECM01882]
3. Install the spacer (if equipped) and the washer. Tighten the propeller nut to the specified torque.

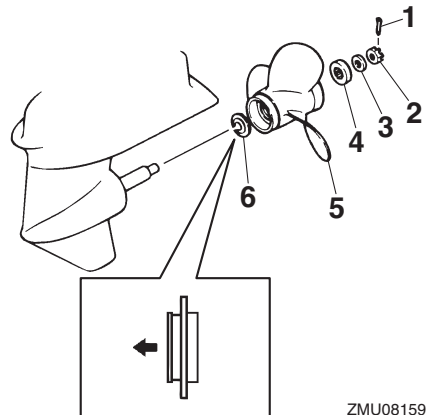

ZMU08159

1. Cotter pin
2. Propeller nut
3. Washer
4. Spacer
5. Propeller
6. Thrust washer

Propeller nut tightening torque:
34 Nm (3.47 kgf-m, 25.1 ft-lb)

4. Align the propeller nut slot with the propeller shaft hole. Insert a new cotter pin in the hole and bend the cotter pin ends. **NOTICE: Do not reuse the cotter pin. Otherwise, the propeller can come off during operation.** [ECM01892]

Maintenance

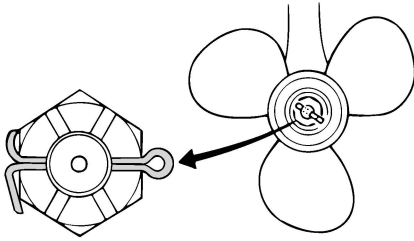

ZMU01805

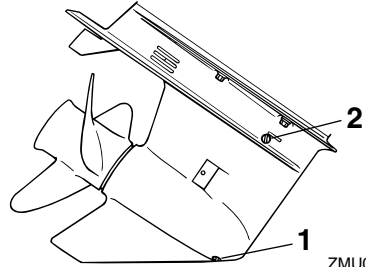

ZMU03273

TIP:

If the propeller nut slot does not align with the propeller shaft hole after tightening the propeller nut to the specified torque, tighten the nut further to align the slot with the hole.

EMU2928C

Changing gear oil

EWM00801

WARNING

- Be sure the outboard motor is securely fastened to the transom or a stable stand. You could be severely injured if the outboard motor falls on you.
- Never get under the lower unit while it is tilted, even when the tilt support lever or knob is locked. Severe injury could occur if the outboard motor accidentally falls.

1. Tilt the outboard motor so that the gear oil drain screw is at the lowest point possible.
2. Place a suitable container under the gear case.
3. Remove the gear oil drain screw and gasket. **NOTICE:** If there is an excessive quantity of metal particles on the magnetic gear oil drain screw, this can indicate lower unit problem. Consult your Yamaha dealer. [ECM01901]

1. Gear oil drain screw
2. Oil level plug

TIP:

- If a magnetic gear oil drain screw is equipped, remove all metal particles from the screw before installing it.
 - Always use new gaskets. Do not reuse the removed gaskets.
4. Remove the oil level plug and gasket to allow the oil to drain completely. **NOTICE:** Check the used gear oil after it has been drained. If the gear oil is milky or contains water or a large amount of metal particles, the gear case may be damaged. Have a Yamaha dealer check and repair the outboard motor. [ECM00714]

TIP:

For disposal of used oil, consult your Yamaha dealer.

5. Put the outboard motor in a vertical position. Using a flexible or pressurized filling device, inject the gear oil into the gear oil drain screw hole.

Recommended gear oil:

YAMALUBE outboard gear oil or Hypoid gear oil

Recommended gear oil grade:

SAE 90 API GL-4

Gear oil quantity:

0.430 L (0.455 US qt, 0.378 Imp.qt)

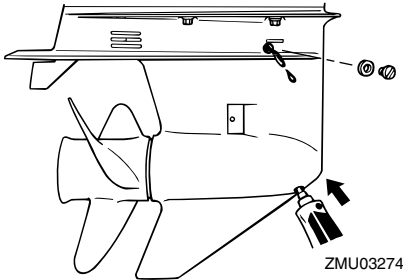

- Put a new gasket on the oil level plug. When the oil begins to flow out of the oil level plug hole, insert and tighten the oil level plug.

Tightening torque:

7 Nm (0.71 kgf-m, 5.2 ft-lb)

- Put a new gasket on the gear oil drain screw. Insert and tighten the gear oil drain screw.

Tightening torque:

7 Nm (0.71 kgf-m, 5.2 ft-lb)

EMU29304

Cleaning fuel tank

EWM00921

WARNING

Gasoline is highly flammable, and its vapors are flammable and explosive.

- If you have any question about properly doing this procedure, consult your Yamaha dealer.
- Keep away from sparks, cigarettes, flames, or other sources of ignition

when cleaning the fuel tank.

- Remove the fuel tank from the boat before cleaning it. Work only outdoors in an area with good ventilation.
- Wipe up any spilled fuel immediately.
- Reassemble the fuel tank carefully. Improper assembly can result in a fuel leak, which could result in a fire or explosion hazard.
- Dispose of old gasoline according to local regulations.

- Empty the fuel tank into an approved container.
- Pour a small amount of suitable solvent into the tank. Install the cap and shake the tank. Drain the solvent completely.
- Remove the screws holding the fuel joint assembly. Pull the assembly out of the tank.

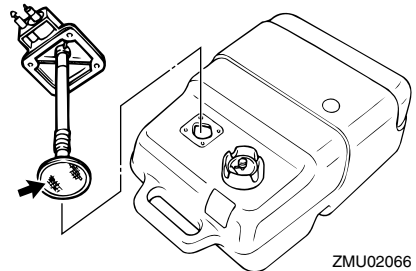

- Clean the filter (located on the end of the suction pipe) in a suitable cleaning solvent. Allow the filter to dry.
- Replace the gasket with a new one. Reinstall the fuel joint assembly and tighten the screws firmly.

EMU29318

Inspecting and replacing anode(s)

Yamaha outboard motors are protected from corrosion by sacrificial anodes. Inspect the external anodes periodically. Remove scales from the surfaces of the anodes. Consult a

Maintenance

Yamaha dealer for replacement of external anodes.

ECM00721

NOTICE

Do not paint anodes, as this would render them ineffective.

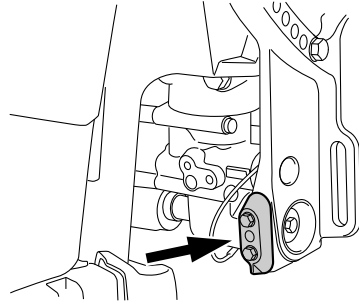
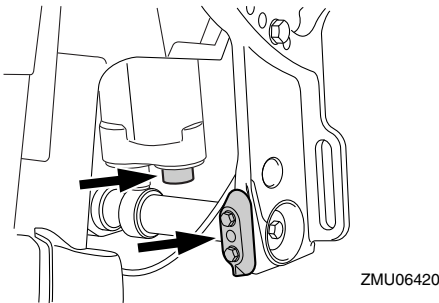
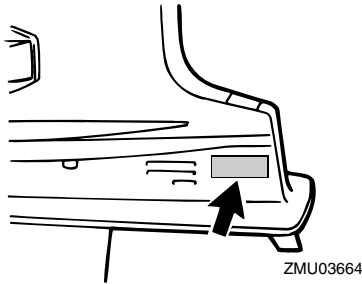
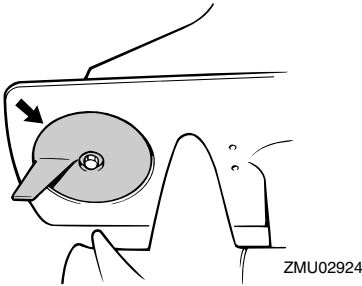

TIP:

Inspect ground leads attached to external anodes on equipped models. Consult a Yamaha dealer for inspection and replacement of internal anodes attached to the power unit.

EMU29324

Checking battery (for electric start models)

EWM01903

WARNING

Battery electrolyte is poisonous and caustic, and batteries generate explosive hydrogen gas. When working near the battery:

- Wear protective eye gear and rubber gloves.
- Do not smoke or bring any other source of ignition near the battery.

The procedure for checking the battery varies for different batteries. This procedure contains typical checks that apply to many batteries, but you should always refer to the battery manufacturer's instructions.

ECM01921

NOTICE

A poorly maintained battery will quickly deteriorate.

1. Check the electrolyte level.

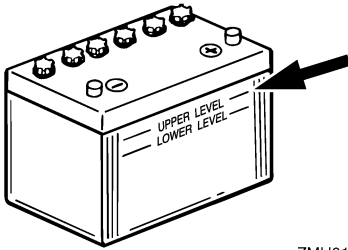

ZMU01810

2. Check the battery's charge. If your boat is equipped with the digital speedometer, the voltmeter and low battery alert functions will help you monitor the battery's charge. If the battery needs charging, consult your Yamaha dealer.
3. Check the battery connections. They should be clean, secure, and covered by an insulating cover. **WARNING! Bad connections can produce shorting or arcing and cause an explosion.**

[EWM01913]

EMU29335

Connecting the battery

EWM00573



WARNING

Mount the battery holder securely in a dry, well-ventilated, vibration-free location in the boat. Install a fully charged battery in the holder.

ECM01125

NOTICE

Do not reverse the battery cables. Otherwise, the electrical parts could be damaged.

1. Make sure the main switch (on applicable models) is "OFF" (off) before working on the battery.
2. Connect the red battery cable to the POSITIVE (+) terminal first. Then con-

nect the black battery cable to the NEGATIVE (-) terminal.

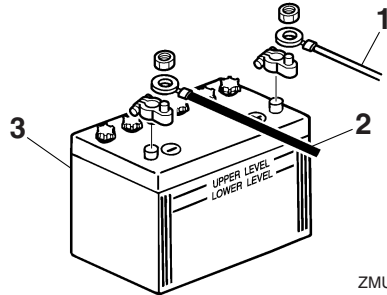

ZMU01811

1. Red cable
 2. Black cable
 3. Battery
3. The electrical contacts of the battery and cables must be clean and properly connected, or the battery will not start the engine.

EMU29372

Disconnecting the battery

1. Turn off the battery cut-off switch (if equipped) and main switch. **NOTICE: If they are left on, the electrical system can be damaged.** [ECM01931]
2. Disconnect the negative cable(s) from the negative (-) terminal. **NOTICE: Always disconnect all negative (-) cables first to avoid a short circuit and damage to the electrical system.**

[ECM01941]

3. Disconnect the positive cable(s) and remove the battery from the boat.
4. Clean, maintain, and store the battery according to the manufacturer's instructions.

EMU38661

Storing the battery

When storing your Yamaha outboard motor for prolonged periods of time (2 months or longer), remove the battery and store it in a

Maintenance

cool, dry place.

Check the battery and charge it if necessary.

EMU29428

Troubleshooting

A problem in the fuel, compression, or ignition systems can cause poor starting, loss of power, or other problems. This section describes basic checks and possible remedies, and covers all Yamaha outboard motors. Therefore some items may not apply to your model.

If your outboard motor requires repair, bring it to your Yamaha dealer.

If the engine trouble-alert indicator is flashing, consult your Yamaha dealer.

Starter will not operate.

Q. Is battery capacity weak or low?

A. Check battery condition. Use battery of recommended capacity.

Q. Are battery connections loose or corroded?

A. Tighten battery cables and clean battery terminals.

Q. Is fuse for electric start relay or electric circuit blown?

A. Check for cause of electric overload and repair. Replace fuse with one of correct amperage.

Q. Are starter components faulty?

A. Have serviced by a Yamaha dealer.

Q. Is shift lever in gear?

A. Shift to neutral.

Engine will not start (starter operates).

Q. Is fuel tank empty?

A. Fill tank with clean, fresh fuel.

Q. Is fuel contaminated or stale?

A. Fill tank with clean, fresh fuel.

Q. Is fuel filter clogged?

A. Clean or replace filter.

Q. Is starting procedure incorrect?

A. See page 44.

Q. Has fuel pump malfunctioned?

A. Have serviced by a Yamaha dealer.

Q. Are spark plug(s) fouled or of incorrect type?

A. Inspect spark plug(s). Clean or replace with recommended type.

Q. Are spark plug cap(s) fitted incorrectly?

A. Check and re-fit cap(s).

Q. Is ignition wiring damaged or poorly connected?

A. Check wires for wear or breaks. Tighten all loose connections. Replace worn or broken wires.

Q. Are ignition parts faulty?

A. Have serviced by a Yamaha dealer.

Q. Is engine shut-off cord (lanyard) not attached?

A. Attach cord.

Q. Are engine inner parts damaged?

A. Have serviced by a Yamaha dealer.

Engine idles irregularly or stalls.

Q. Are spark plug(s) fouled or of incorrect type?

A. Inspect spark plug(s). Clean or replace with recommended type.

Trouble Recovery

Q. Is fuel system obstructed?

A. Check for pinched or kinked fuel line or other obstructions in fuel system.

Q. Is fuel contaminated or stale?

A. Fill tank with clean, fresh fuel.

Q. Is fuel filter clogged?

A. Clean or replace filter.

Q. Have ignition parts failed?

A. Have serviced by a Yamaha dealer.

Q. Has alert system activated?

A. Find and correct cause of alert.

Q. Is spark plug gap incorrect?

A. Inspect and adjust as specified.

Q. Is ignition wiring damaged or poorly connected?

A. Check wires for wear or breaks. Tighten all loose connections. Replace worn or broken wires.

Q. Is specified engine oil not being used?

A. Check and replace oil as specified.

Q. Is thermostat faulty or clogged?

A. Have serviced by a Yamaha dealer.

Q. Are carburetor adjustments incorrect?

A. Have serviced by a Yamaha dealer.

Q. Is fuel pump damaged?

A. Have serviced by a Yamaha dealer.

Q. Is air vent screw on fuel tank closed?

A. Open air vent screw.

Q. Is choke knob pulled out?

A. Return to home position.

Q. Is motor angle too high?

A. Return to normal operating position.

Q. Is carburetor clogged?

A. Have serviced by a Yamaha dealer.

Q. Is fuel joint connection incorrect?

A. Connect correctly.

Q. Is throttle valve adjustment incorrect?

A. Have serviced by a Yamaha dealer.

Q. Is battery cable disconnected?

A. Connect securely.

Alert buzzer sounds or indicator lights.

Q. Is cooling system clogged?

A. Check water intake for restriction.

Q. Is engine oil level low?

A. Fill oil tank with specified engine oil.

Q. Is heat range of spark plug incorrect?

A. Inspect spark plug and replace it with recommended type.

Q. Is specified engine oil not being used?

A. Check and replace oil with specified type.

Q. Is engine oil contaminated or deteriorated?

A. Replace oil with fresh, specified type.

Q. Is oil filter clogged?

A. Have serviced by a Yamaha dealer.

Q. Has oil feed/injection pump malfunctioned?

A. Have serviced by a Yamaha dealer.

Trouble Recovery

Q. Is load on boat improperly distributed?

A. Distribute load to place boat on an even plane.

Q. Is water pump or thermostat faulty?

A. Have serviced by a Yamaha dealer.

Q. Is there excess water in fuel filter cup?

A. Drain filter cup.

Engine power loss.

Q. Is propeller damaged?

A. Have propeller repaired or replaced.

Q. Is propeller pitch or diameter incorrect?

A. Install correct propeller to operate outboard at its recommended speed (r/min) range.

Q. Is trim angle incorrect?

A. Adjust trim angle to achieve most efficient operation.

Q. Is motor mounted at incorrect height on transom?

A. Have motor adjusted to proper transom height.

Q. Has alert system activated?

A. Find and correct cause of alert.

Q. Is boat bottom fouled with marine growth?

A. Clean boat bottom.

Q. Are spark plug(s) fouled or of incorrect type?

A. Inspect spark plug(s). Clean or replace with recommended type.

Q. Are weeds or other foreign matter tangled

on gear housing?

A. Remove foreign matter and clean lower unit.

Q. Is fuel system obstructed?

A. Check for pinched or kinked fuel line or other obstructions in fuel system.

Q. Is fuel filter clogged?

A. Clean or replace filter.

Q. Is fuel contaminated or stale?

A. Fill tank with clean, fresh fuel.

Q. Is spark plug gap incorrect?

A. Inspect and adjust as specified.

Q. Is ignition wiring damaged or poorly connected?

A. Check wires for wear or breaks. Tighten all loose connections. Replace worn or broken wires.

Q. Have electrical parts failed?

A. Have serviced by a Yamaha dealer.

Q. Is specified fuel not being used?

A. Replace fuel with specified type.

Q. Is specified engine oil not being used?

A. Check and replace oil with specified type.

Q. Is thermostat faulty or clogged?

A. Have serviced by a Yamaha dealer.

Q. Is air vent screw closed?

A. Open the air vent screw.

Q. Is fuel pump damaged?

A. Have serviced by a Yamaha dealer.

Trouble Recovery

Q. Is fuel joint connection incorrect?

A. Connect correctly.

Q. Is heat range of spark plug incorrect?

A. Inspect spark plug and replace it with recommended type.

Q. Is high pressure fuel pump drive belt broken?

A. Have serviced by a Yamaha dealer.

Q. Is engine not responding properly to shift lever position?

A. Have serviced by a Yamaha dealer.

Engine vibrates excessively.

Q. Is propeller damaged?

A. Have propeller repaired or replaced.

Q. Is propeller shaft damaged?

A. Have serviced by a Yamaha dealer.

Q. Are weeds or other foreign matter tangled on propeller?

A. Remove and clean propeller.

Q. Is motor mounting bolt loose?

A. Tighten bolt.

Q. Is steering pivot loose or damaged?

A. Tighten or have serviced by a Yamaha dealer.

EMU29434

Temporary action in emergency

EMU29442

Impact damage

EWM00871



The outboard motor can be seriously damaged by a collision while operating or

trailing. Damage could make the outboard motor unsafe to operate.

If the outboard motor hits an object in the water, follow the procedure below.



1. Stop the engine immediately.
2. Check the control system and all components for damage. Also, check the boat for damage.
3. Whether damage is found or not, return to the nearest harbor slowly and carefully.
4. Have a Yamaha dealer check the outboard motor before operating it again.

EMU30684

Replacing fuse

If a fuse has blown, open the fuse holder and remove the fuse with a fuse puller. Replace it with a spare one of the proper amperage.

EWM00632



Substituting an incorrect fuse or a piece of wire could allow excessive current flow. This could cause electric system damage and a fire hazard.

Consult your Yamaha dealer if the new fuse immediately blows again.

Trouble Recovery

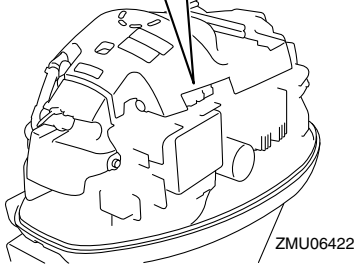
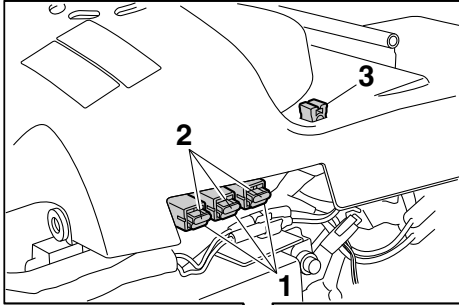

1. Fuse (20 A × 2, 30 A)
2. Spare fuse (20 A × 2, 30 A)
3. Fuse puller

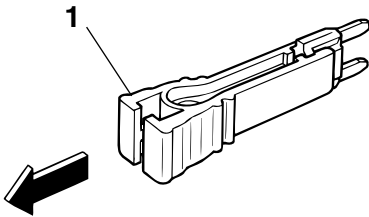

1. Fuse puller

EMU29513

Power trim and tilt will not operate

If the engine cannot be tilted up or down with the power trim and tilt because of a discharged battery or a failure with the power

trim and tilt unit, the engine can be tilted manually.

1. Loosen the manual valve screw by turning it clockwise until it stops.

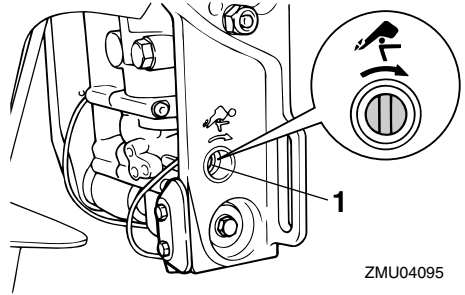

1. Manual valve screw

2. Put the engine in the desired position, then tighten the manual valve screw by turning it counterclockwise.

EMU37573

Water separator-alert indicator blinks while cruising

EWWM01501

WARNING

Gasoline is highly flammable, and its vapors are flammable and explosive.

- Do not perform this procedure on a hot or running engine. Allow the engine to cool.
- There will be fuel in the fuel filter. Keep away from sparks, cigarettes, flames or other sources of ignition.
- This procedure will allow some fuel to spill. Catch fuel in a rag. Wipe up any spilled fuel immediately.
- The fuel filter must be reassembled carefully with the O-ring, filter cup, and hoses in place. Improper assembly or replacement could result in a fuel leak, which could result in a fire or explosion hazard.

Trouble Recovery

If the water separator-alert indicator blinks, perform the following procedure.

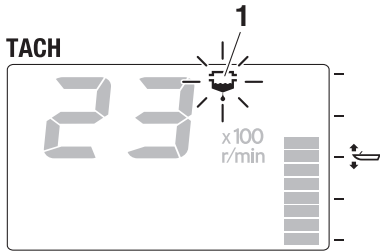

ZMU05441

1. Water separator-alert indicator

1. Stop the engine.
2. Remove the top cowling.
3. Remove the holder.

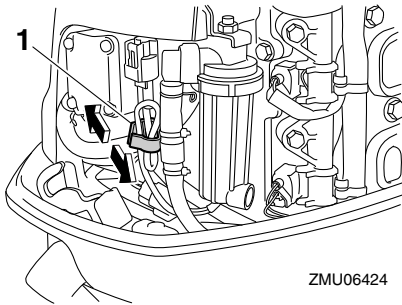

ZMU06424

1. Holder

4. Disconnect the water detection switch coupler. **NOTICE: Be careful not to get any water on the water detection switch coupler, otherwise a malfunction could occur.** [ECM01951]

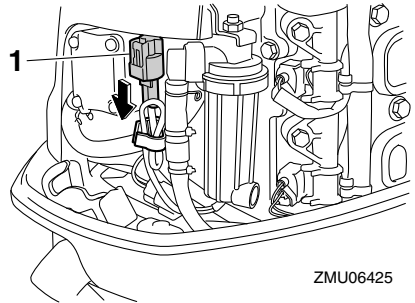

ZMU06425

1. Water detection switch coupler

5. Unscrew the filter cup from the filter housing. **NOTICE: Be careful not to twist the water detection switch lead when unscrewing the filter cup.**

[ECM01961]

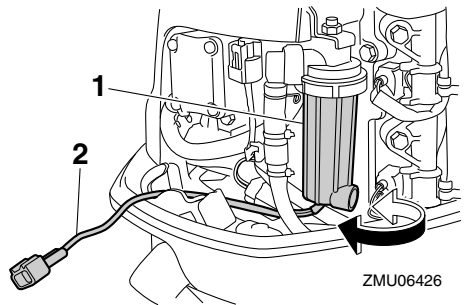

ZMU06426

1. Filter cup
2. Water detection switch lead

6. Drain the water in the filter cup by soaking it up with a rag.
7. Firmly screw the filter cup onto the filter housing. **NOTICE: Be careful not to twist the water detection switch lead when screwing the filter cup onto the filter housing.** [ECM01971]
8. Connect the water detection switch coupler securely until a click is heard.

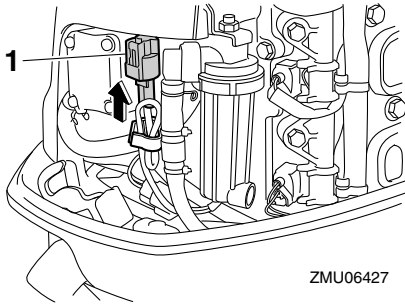

ZMU06427

1. Water detection switch coupler

9. Fasten the water detection switch lead with the holder.

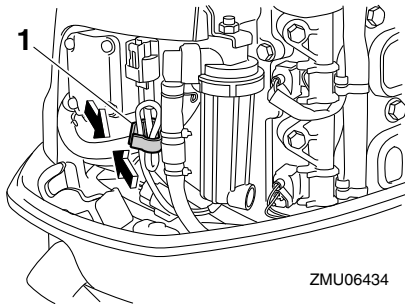

ZMU06434

1. Holder

10. Install the top cowling.

11. Start the engine and make sure that the water separator-alert indicator remains off. Have a Yamaha dealer inspect the outboard motor after returning to port.

EMU29543

Starter will not operate

If the starter mechanism does not operate (the engine cannot be cranked with the starter), the engine can be started manually with an emergency starter rope. However, the engine cannot be started manually if the battery voltage is low. If the battery is discharged to 9 volts or below, the electric fuel pump will not operate.

EWM01023

WARNING

- Use this procedure only in an emergency to return to the nearest port for repairs.
- When the emergency starter rope is used to start the engine, the start-in-gear protection device does not operate. Make sure the remote control lever is in neutral. Otherwise the boat could unexpectedly start to move, which could result in an accident.
- Attach the engine shut-off cord to a secure place on your clothing, or your arm or leg while operating the boat.
- Do not attach the cord to clothing that could tear loose. Do not route the cord where it could become entangled, preventing it from functioning.
- Avoid accidentally pulling the cord during normal operation. Loss of engine power means the loss of most steering control. Also, without engine power, the boat could slow rapidly. This could cause people and objects in the boat to be thrown forward.
- Make sure no one is standing behind you when pulling the starter rope. It could whip behind you and injure someone.
- An unguarded, rotating flywheel is very dangerous. Keep loose clothing and other objects away when starting the engine. Use the emergency starter rope only as instructed. Do not touch the flywheel or other moving parts when the engine is running. Do not install the starter mechanism or top cowling after the engine is running.
- Do not touch the ignition coil, spark plug wire, spark plug cap, or other elec-

Trouble Recovery

trical components when starting or operating the motor. You could get an electrical shock.

EMU44403

Emergency starting engine

1. Remove the top cowling.
2. Remove the flywheel cover after removing the bolt.

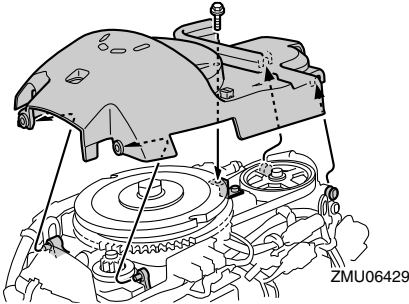

3. Prepare the engine for starting. For further information, see page 44. Be sure the engine is in neutral and that the clip is attached to the engine shut-off switch.

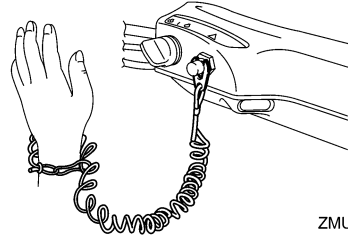
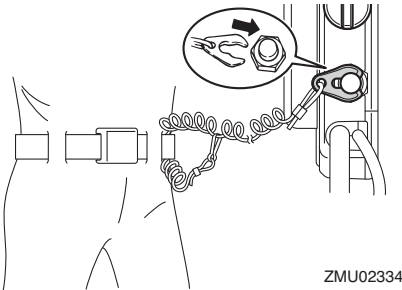

4. Turn on the main switch.

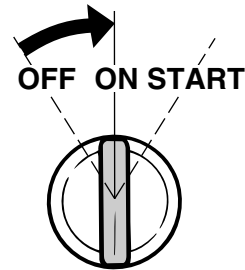

5. Insert the knotted end of the emergency starter rope into the notch in the flywheel rotor and wind the rope around the flywheel several turns clockwise.
6. Give a strong pull straight out to crank the engine. Repeat if necessary. **WARNING! Do not install the top cowling when engine is running.**

[EWM00622]

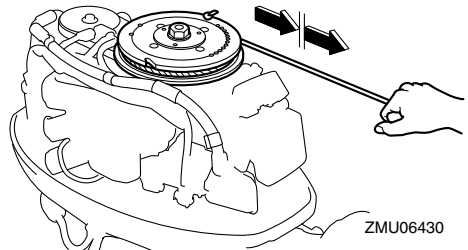

EMU33502

Treatment of submerged motor

If the outboard motor is submerged, immediately take it to a Yamaha dealer. Otherwise some corrosion may begin almost immediately. **NOTICE: Do not attempt to run the outboard motor until it has been completely inspected.** [ECM00402]

INDEX

- 6**
6Y8 Multifunction meters 30
- A**
Alcohol and drugs 2
Alert indicator 25
Alert system 34
Anode(s), inspecting and replacing 77
Anti-fouling paint 13
Avoid collisions 3
- B**
Battery 42
Battery, checking (electric start models) 78
Battery, connecting 79
Battery, disconnecting 79
Battery requirements 11
Battery, storing 79
Boat horsepower rating 10
Boating safety 2
Boating safety publications 3
Breaking in engine 38
- C**
Carbon monoxide 2
CE Marking 5
Checks after engine warm up 48
Checks after starting engine 47
Checks before starting engine 38
Cleaning the outboard motor 64
Clock 29
Components diagram 15
Control functions, checking 39
Cooling water 47
Cowling lock lever 24
Cruising in salt water or other conditions 59
- D**
Digital speedometer 28
Digital tachometer 26
- E**
EC Declaration of Conformity (DoC) 4
Electric shock 1
Emergency equipment 14
Emergency starting engine 88
Emergency, temporary action in 84
Engine, checking 41
Engine oil 40
Engine oil, changing 71
Engine oil, filling 38
Engine oil requirements 12
Engine shut-off cord (lanyard) 1, 40
Engine shut-off cord (lanyard) and clip 20
Engine stop button 20
- F**
Filling fuel 42
First-time operation 38
Flushing device 24, 41
Flushing in a test tank 61
Flushing power unit 63
Flushing with the flushing attachment 62
Fuel filter, checking 39
Fuel filter/Water separator 25
Fuel gauge 28
Fuel leaks, checking for 39
Fuel level 39
Fuel level-alert indicator 30
Fuel requirements 13
Fuel system 39
Fuel tank 16
Fuel tank, cleaning 77
Fuse, replacing 84
- G**
Gasoline 1, 13
Gasoline exposure and spills 2
Gear oil, changing 76
Gear shift lever 19
Greasing 69

H		Overloading	2
	Hot parts		1
	Hour meter.....		27
I		P	
	Identification numbers record	Passengers.....	2
	Idle speed, inspecting	Passenger training.....	3
	Impact damage.....	People in the water	2
	Installation requirements.....	Periodic maintenance	65
	Instruments and indicators.....	Personal flotation devices (PFDs)	2
K		Power trim and tilt	1
	Key number	Power trim and tilt switch (bottom cowling)	22
L		Power trim and tilt switch (remote control or tiller handle)	22
	Laws and regulations.....	Power trim and tilt system, checking.....	42
	Low battery voltage-alert indicator.....	Power trim and tilt will not operate	85
	Low oil pressure alert.....	Propeller	1
	Low oil pressure-alert indicator.....	Propeller, checking	74
	Lubrication	Propeller, installing	75
		Propeller, removing.....	75
M		Propeller selection	11
	Main switch.....	R	
	Maintenance chart 1	Read manuals and labels	6
	Maintenance chart 2	Remote control box.....	17
	Modifications.....	Remote control lever.....	18
	Motor disposal requirements	Remote control requirements	11
	Mounting height	Replacement parts.....	65
	Mounting motor.....	Rotating parts	1
	Mounting the outboard motor.....	S	
	Muddy or acidic water	Sending fuel (portable tank).....	44
N		Severe operating conditions	65
	Neutral interlock trigger.....	Shallow water	57
	Neutral throttle lever	Shifting.....	48
O		Shifting (checks after engine warm up)	48
	Operating engine	Spark plug, cleaning and adjusting	70
	Outboard motor (painted surface), checking	Specifications.....	9
	Outboard motor safety	Speedometer	28
	Outboard motor serial number.....	Starter will not operate	87
	Overheat alert.....	Start-in-gear protection	12
	Overheat-alert indicator	Starting engine.....	44
		Steering friction adjuster	21
		Stopping boat.....	49

INDEX

Stopping engine.....	50
Stop switches.....	48
Storing outboard motor.....	60
Submerged outboard motor.....	89

T

Tachometer.....	27
Throttle friction adjuster.....	19
Throttle grip.....	19
Throttle indicator.....	19
Tiller handle.....	19
Tilting up and down.....	53
Tilt lock mechanism.....	24
Tilt support knob.....	24
Top cowling, installing.....	41
Top cowling, removing.....	39
Transporting and storing outboard motor.....	60
Trim meter.....	27
Trimming outboard motor.....	51
Trim tab with anode.....	23
Trip meter.....	29
Trolling.....	50
Troubleshooting.....	81

V

Variable trolling RPM switches.....	23
Voltmeter.....	30

W

Warming up engine.....	47
Warning labels.....	6
Water separator-alert indicator blinks while cruising.....	85
Weather.....	3
Wiring and connectors, inspecting.....	74

Y

Yamaha Security System (Y-COP).....	17
-------------------------------------	----

