



**2020 WaveRunner  
EX  
EX Sport  
EX Deluxe**

**OWNER'S/OPERATOR'S MANUAL**

**▲ Read this manual carefully  
before operating this watercraft.**

---

**YAMAHA MOTOR CO., LTD.**  
F3Y-F8199-73-E0

**Read this manual carefully before operating this watercraft. This manual should stay with the WaveRunner if it is sold.**

# Important manual information

EJU44333

## Declaration of Conformity for Personal Watercraft (PWC) with the requirements of Directive 2013/53/EU

Name of PWC Manufacturer: YAMAHA MOTOR CO., LTD.

Address: 2500 Shingai, Iwata, Shizuoka 438-8501, Japan

Name of Authorised Representative: YAMAHA MOTOR EUROPE N.V.

Address: Koolhovenlaan 101, 1119 NC Schiphol-Rijk, The Netherlands

Name of Notified Body for exhaust and noise emission assessment: SNCH ID Number: 0499

Address: 11, route de Luxembourg BP 32, Sandweiler, L-5230, Luxembourg

### Conformity assessment module used:

for construction: A  A1  B+C  B+D  B+E  B+F  G  H

for exhaust emissions: B+C  B+D  B+E  B+F  G  H

for noise emissions: A  A1  G  H

Other Community Directives applied		Standards	
<input checked="" type="checkbox"/>	Electromagnetic Compatibility Directive 2014/30/EU	<input checked="" type="checkbox"/>	EN 55012:2007/A1:2009
		<input checked="" type="checkbox"/>	EN 61000-6-1:2007
		<input checked="" type="checkbox"/>	EN 61000-6-2:2005

### DESCRIPTION OF WATERCRAFT

Craft Identification Number : starting from

U S - Y A M A 0 0 0 1 G 9 2 0

Design Category : C  D

Model name / Commercial name : EX1050A-V / EX Deluxe, EX1050B-V / EX Sport, EX1050C-V / EX

### DESCRIPTION OF ENGINE

Model Name:	Fuel Type:	Combustion Cycle:
6GA	Petrol	4 stroke

### ESSENTIAL REQUIREMENTS

Essential requirements	Standards	Other normative document / method	Technical file	Please specify in more detail (* = mandatory standard)
Annex I.A Design and construction	<input checked="" type="checkbox"/> *	<input type="checkbox"/>	<input checked="" type="checkbox"/>	*EN ISO 13590:2003 *EN ISO 13590:2003/AC:2004
Annex I.B Exhaust emission	<input checked="" type="checkbox"/> *	<input type="checkbox"/>	<input checked="" type="checkbox"/>	*EN ISO 18854:2015
Annex I.C Noise emission	<input checked="" type="checkbox"/> *	<input type="checkbox"/>	<input checked="" type="checkbox"/>	*EN ISO 14509-1:2008

This declaration of conformity is issued under the sole responsibility of the manufacturer. I declare on behalf of the manufacturer that the PWCs mentioned above comply with all applicable essential requirements in the way specified.

Name / Title: T. Ibata / Director, Boat Section

(identification of the person empowered to sign on behalf of the manufacturer)

Signature: 

Date and place of issue: July 1st, 2019, Shizuoka, Japan

# Important manual information

---

EJU30193

## To the owner/operator

Thank you for choosing a Yamaha watercraft. This owner's/operator's manual contains information you will need for proper operation, maintenance, and care. If you have any questions about the operation or maintenance of your watercraft, please consult a Yamaha dealer.

This manual is not a course on boating safety or seamanship. If this is your first watercraft, or if you are changing to a type of watercraft you are not familiar with, for your own comfort and safety, please ensure that you obtain proper training or practice before operating the watercraft by yourself. In addition, a Yamaha dealer or boating organization will be pleased to recommend local sea schools, or competent instructors.

In this manual, information of particular importance is distinguished in the following ways:

 This is the safety alert symbol. It is used to alert you to potential personal injury hazards. Obey all safety messages that follow this symbol to avoid possible injury or death.

EWJ00072

### **WARNING**

**A WARNING indicates a hazardous situation which, if not avoided, could result in death or serious injury.**

---

ECJ00092

### **NOTICE**

**A NOTICE indicates special precautions that must be taken to avoid damage to the watercraft or other property.**

---

### **TIP:**

A TIP provides key information to make procedures easier or clearer.

EJU45451

## Engine data recording

This model's ECM stores certain engine data to assist in the diagnosis of malfunctions and for research, statistical analysis and development purposes.

Although the sensors and recorded data will vary by model, the main data points are:

- Engine status and engine performance data

This data will be uploaded only when a special Yamaha diagnostic tool is attached to the engine, such as when maintenance checks or service procedures are performed. Engine data uploaded will be handled appropriately according to the following Privacy Policy.

### **Privacy Policy**

<https://www.yamaha-motor.eu/eu/privacy/privacy-policy.aspx>

Yamaha will not disclose this data to a third party except in the following cases. In addition, Yamaha may provide engine data to a contractor in order to outsource services related to the handling of the engine data. Even in this case, Yamaha will require the contractor to properly handle the engine data we provided and Yamaha will appropriately manage the data.

- With the consent of the boat owner
- Where obligated by law
- For use by Yamaha in litigation
- For general Yamaha-conducted research purposes when the data is not related to an individual engine or owner

# Important manual information

---

EJU40411

Because Yamaha has a policy of continuing product improvement, this product may not be exactly as described in this owner's/operator's manual. Specifications are subject to change without notice.

This manual should be considered a permanent part of this watercraft and should remain with it even if the watercraft is subsequently sold.

EJU30234

**WaveRunner EX / EX Sport / EX Deluxe  
OWNER'S/OPERATOR'S MANUAL  
©2020 by Yamaha Motor Co., Ltd.  
1st Edition, May 2019  
All rights reserved.  
Any reprinting or unauthorized use  
without the written permission of  
Yamaha Motor Co., Ltd.  
is expressly prohibited.  
Printed in U.S.A.**

# Table of contents

---

<b>General and important labels</b> .....	<b>1</b>	<b>Watercraft operation</b> .....	<b>29</b>
Identification numbers .....	1	Watercraft operation functions .....	29
Primary Identification (PRI-ID)		Reverse system (EX Sport).....	29
number.....	1	Shift system (EX Deluxe) .....	29
Craft Identification Number (CIN).....	2		
Engine serial number.....	2	<b>Instrument operation</b> .....	<b>33</b>
Manufactured date label .....	2	Multifunction information center...	33
Model information .....	3	Information display.....	33
Builder's plate .....	3		
Important labels .....	4	<b>Equipment operation</b> .....	<b>38</b>
Warning labels.....	5	Equipment.....	38
Other labels .....	9	Seat .....	38
		Handgrip.....	38
<b>Safety information</b> .....	<b>10</b>	Reboarding grip.....	39
Limitations on who may operate		Reboarding step	
the watercraft.....	10	(EX Sport / EX Deluxe) .....	39
Cruising limitations.....	11	Bow eye.....	40
Operation requirements .....	12	Stern eyes .....	40
Recommended equipment .....	14	Cleat .....	40
Hazard information.....	15	Storage compartments .....	40
Watercraft characteristics .....	15	Fire extinguisher holder .....	43
Wakeboarding and water-skiing ...	17		
Safe boating rules .....	18	<b>Operation and handling</b>	
Enjoy your watercraft		<b>requirements</b> .....	<b>44</b>
responsibly.....	19	Fuel requirements .....	44
		Fuel.....	44
<b>Description</b> .....	<b>20</b>	Engine oil requirements .....	46
Watercraft glossary .....	20	Engine oil.....	46
Location of main components .....	21	Draining the bilge water .....	48
		Draining the bilge water on land.....	48
<b>Control function operation</b> .....	<b>25</b>	Draining the bilge water on water ....	49
Watercraft control functions .....	25	Transporting on a trailer.....	50
Engine stop switch .....	25		
Engine shut-off switch .....	25	<b>First-time operation</b> .....	<b>51</b>
Start switch .....	25	Engine break-in.....	51
Throttle lever .....	26		
RiDE lever (EX Deluxe) .....	26	<b>Pre-operation checks</b> .....	<b>52</b>
Steering system .....	26	Pre-operation checklist .....	52
Cooling water pilot outlet .....	27	Pre-operation check points .....	54
Water separator.....	27	Pre-launch checks .....	54
		Post-launch checks.....	60

# Table of contents

---

<b>Operation .....</b>	<b>62</b>	<b>Specifications.....</b>	<b>87</b>
Operating your watercraft .....	62	Specifications .....	87
Getting to know your watercraft .....	62		
Learning to operate your watercraft.....	62	<b>Trouble recovery.....</b>	<b>88</b>
Riding position .....	63	Troubleshooting.....	88
Launching the watercraft .....	63	Troubleshooting chart .....	88
Starting the engine on water .....	63	Emergency procedures .....	91
Stopping the engine .....	64	Cleaning the jet intake and impeller .....	91
Leaving the watercraft.....	64	Raising the reverse gate (EX Deluxe).....	92
Operating the watercraft .....	64	Jumping the battery .....	92
Turning the watercraft .....	66	Towing the watercraft.....	93
Stopping the watercraft .....	67	Submerged watercraft .....	93
Operating the watercraft in reverse or neutral (EX Sport / EX Deluxe).....	68		
Boarding the watercraft .....	69	<b>Index.....</b>	<b>95</b>
Starting off.....	72		
Capsized watercraft .....	73		
Beaching and docking the watercraft.....	74		
Operating in weeded areas .....	74		
After removing the watercraft from the water .....	75		
<b>Care and storage.....</b>	<b>76</b>		
Post-operation care .....	76		
Flushing the cooling water passages.....	76		
Cleaning the watercraft .....	77		
Battery care.....	77		
Long-term storage .....	80		
Cleaning .....	80		
Lubrication .....	80		
Rustproofing.....	81		
<b>Maintenance .....</b>	<b>83</b>		
Maintenance.....	83		
Periodic maintenance chart .....	84		
Engine oil and oil filter .....	86		

# General and important labels

EJU36452

## Identification numbers

Record the Primary Identification (PRI-ID) number, Craft Identification Number (CIN), and engine serial number in the spaces provided for assistance when ordering spare parts from a Yamaha dealer. Also record and keep these ID numbers in a separate place in case your watercraft is stolen.

EJU30284

## Primary Identification (PRI-ID) number

The PRI-ID number is stamped on a plate attached inside the engine compartment. (See page 38 for seat removal and installation procedures and page 42 for information on the seat storage compartment.)

## MODEL:

EX1050C-V (EX)

EX1050B-V (EX Sport)

EX1050A-V (EX Deluxe)

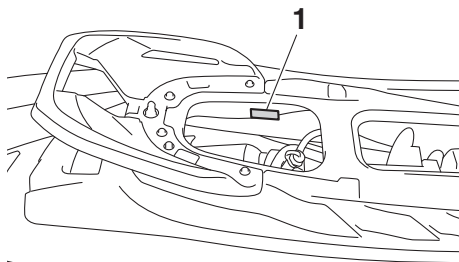

1 Primary Identification (PRI-ID) number location

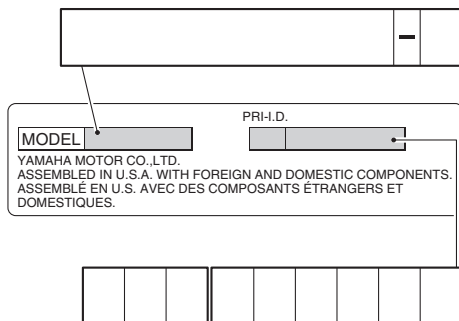





# General and important labels

EJU30321

## Model information

EJU30333

### Builder's plate

Watercraft with this label conform to certain portions of the European Parliament directive relating to machinery.

Part of the information is given on the builder's plate affixed on the craft. A full explanation of this information is given in the relevant sections of this manual.

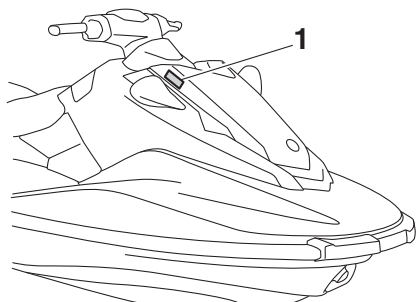

1 Builder's plate location

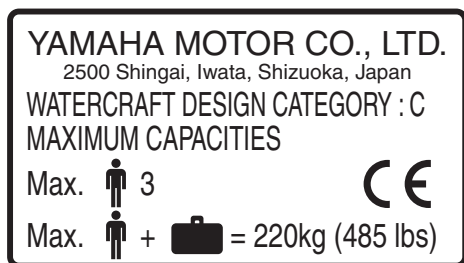

**Design category of this personal watercraft: C**

### Category C:

This watercraft is designed to operate in winds up to Beaufort force 6 and the associated wave heights (significant wave heights up to 2 m (6.56 ft); see the following TIP). Such conditions may be encountered in exposed inland waters, in estuaries, and in coastal waters in moderate weather conditions.

### TIP:

The significant wave height is the mean height of the highest one-third of the waves, which approximately corresponds to the wave height estimated by an experienced observer. However, some waves will be double this height.

# General and important labels

EJU30454

## Important labels

Read the following labels before using this watercraft. If you have any questions, consult a Yamaha dealer.

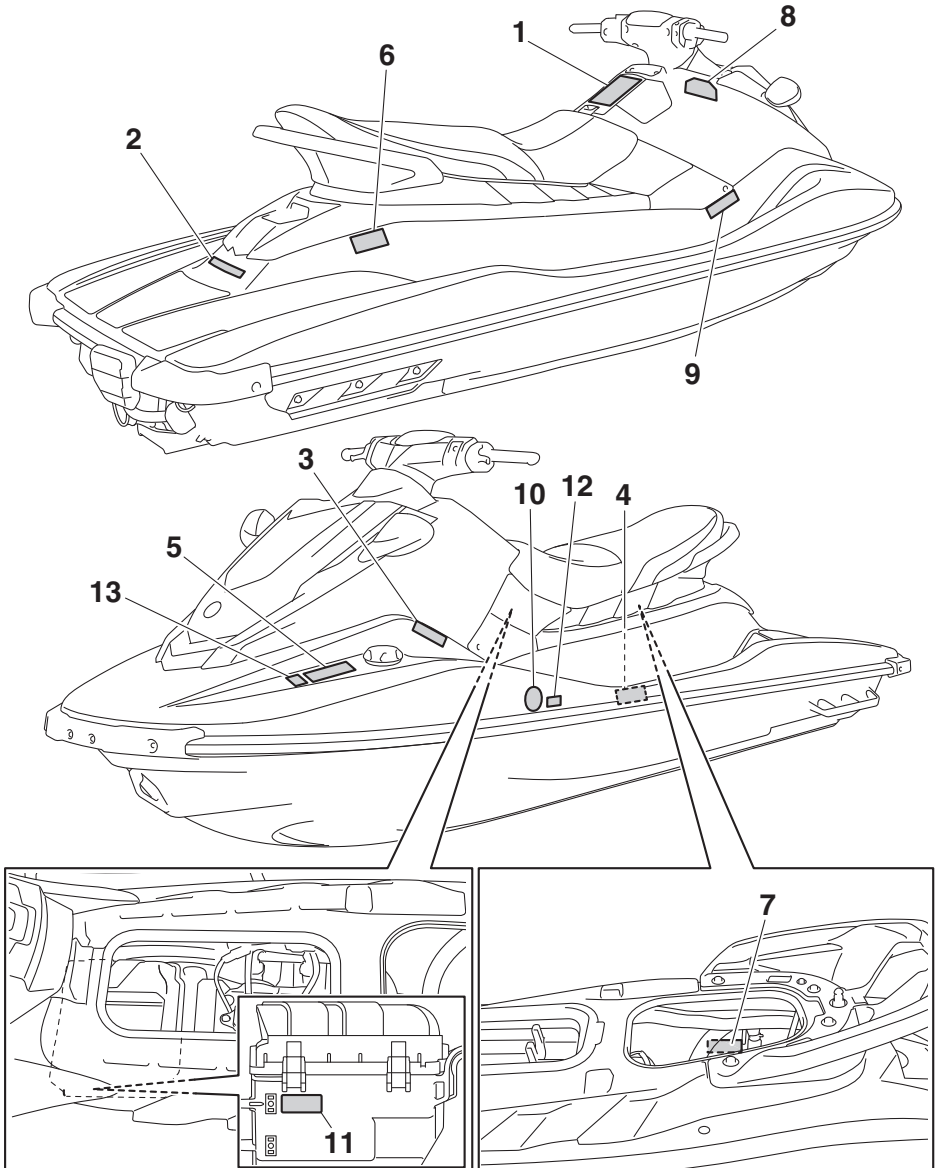

# General and important labels

EJU35914

## Warning labels

If any of these labels are damaged or missing, contact a Yamaha dealer for replacements.

1

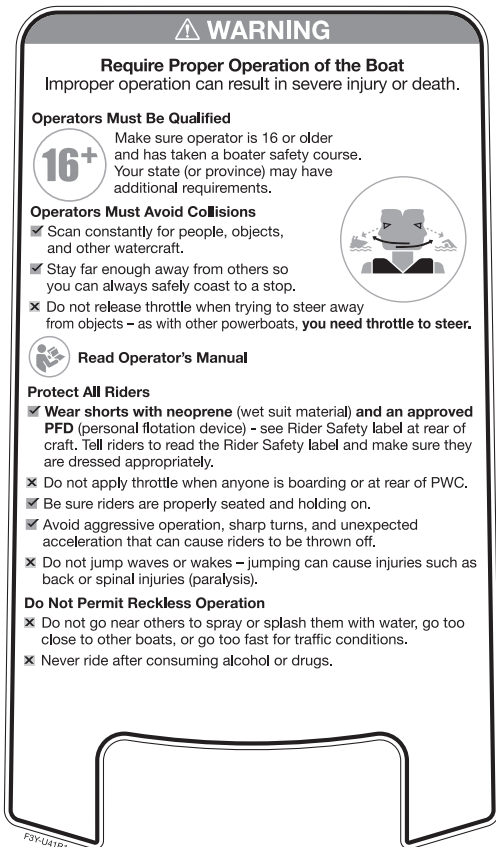

# General and important labels

2

**⚠ WARNING**

**Falls Can Result in Severe Injury or Death**

- ✔ You must wear shorts with neoprene (wet suit material) to keep water from being forcefully injected into rectum or vagina during a fall backward. Riders not wearing neoprene shorts have received severe rectal, vaginal, and internal injuries resulting in permanent damage.
- ✔ You must wear an approved PFD (personal flotation device).
- ✔ Be sure you are properly seated and holding on. Riders can be thrown off PWC during unexpected acceleration or aggressive operation.
- ✘ Never ride after consuming alcohol or drugs.



**RIDER SAFETY**

**See Operator's Manual**

F3E-U11E1-00  
F3E-U41E1-00

3

**⚠ AVERTISSEMENT**

**Les chutes peuvent provoquer des blessures graves ou la mort**

- ✔ Vous devez porter des shorts avec du néoprène (matériaux pour costume mouillé) pour empêcher l'eau d'être injectée avec force dans le rectum ou le vagin pendant une chute en arrière. Des passagers ne portant pas de shorts en néoprène ont subi des blessures rectales, vaginales et internes graves résultant en des dommages permanents.
- ✔ Vous devez porter un PFD agréé (dispositif de flottaison personnel).
- ✔ Assurez-vous que vous êtes convenablement assis et bien agrippé. Les passagers peuvent être jetés hors de l'embarcation pendant une accélération inattendue ou une manœuvre brusque.
- ✘ Ne conduisez jamais après avoir consommé de l'alcool ou de la drogue.



**SÉCURITÉ DES UTILISATEURS**

**Voyez le manuel de l'utilisateur**

F3A-U11B1-00  
F3V-U41B1-00

4

**⚠ AVERTISSEMENT**

**Exigez une conduite appropriée du bateau**

**Les opérateurs doivent être qualifiés**

**16+** Assurez-vous que l'opérateur a au moins 16 ans et a suivi un cours de sécurité pour les bateaux. Votre État (ou province) peut imposer des exigences supplémentaires.

**Les opérateurs doivent éviter les collisions**

- ✔ Analyse et recherche constamment les personnes, les objets et d'autres embarcations.
- ✔ Restez à une distance suffisante des autres de sorte que vous puissiez toujours accoster en roue libre.
- ✘ Ne libérez pas l'accélérateur lorsque vous essayez de vous éloigner d'objets - comme avec d'autres bateaux à moteur, vous devez accélérer pour vous diriger.

 **Lisez le manuel de l'utilisateur**

**Un pilotage inappropriée peut entraîner des blessures graves ou la mort.**

**Protégez tous les utilisateurs**

- ✔ **Portez des shorts avec du néoprène** (matériau de costume mouillé) et un **PFD agréé** (dispositif de flottaison personnelle) - voir l'étiquette pour la sécurité de l'utilisateur à l'arrière de l'embarcation. Dites aux passagers de lire l'étiquette de sécurité pour utilisateurs et assurez-vous qu'ils sont vêtus de manière appropriée.
- ✘ Ne pas actionner l'accélération lorsque quelqu'un embarque ou se trouve à l'arrière du bateau à moteur.
- ✔ Assurez-vous que les utilisateurs sont convenablement assis et qu'ils se tiennent aux appuis.
- ✔ Évitez les manœuvres agressives, les virages brusques et les accélérations inattendues qui pourraient provoquer la chute des usagers par-dessus bord.
- ✘ Ne sautez pas sur les vagues ou sillages - les sauts peuvent causer de blessures telles que les blessures du dos ou de la colonne vertébrales (paralysie).

**Ne permettez pas une conduite imprudente**

- ✘ Ne vous approchez pas des autres pour les arroser ou les éclabousser avec de l'eau, ne vous rapprochez pas trop des autres bateaux, et ne conduisez pas trop vite en fonction du trafic.
- ✘ Ne conduisez jamais après avoir consommé de l'alcool ou de la drogue.

F3W-U11B1-00  
F3W-U41B1-10

# General and important labels

5

<b>⚠ WARNING</b>	<b>⚠ AVERTISSEMENT</b>
Gasoline is highly flammable and explosive. A fire or explosion could cause severe injury or death. Shut engine off. Refuel in well ventilated area away from flames or sparks. Do not smoke. Avoid spilling gasoline. Wipe up spilled gasoline immediately. Remove all seats and compartments under the seats to ventilate fuel vapors from engine compartment before starting engine. Do not start engine if there is a fuel leak or a loose electrical connection.	L'essence est très inflammable et explosible. Un incendie ou une explosion risquent de provoquer des blessures graves, voire mortelles. Couper le moteur. Faire le plein dans un endroit bien aéré et éloigné de toute flamme ou étincelle. Ne pas fumer. Éviter de renverser de l'essence. Essuyer immédiatement toute coulure d'essence. Retirez tous les sièges et les compartiments sous les sièges pour ventiler les vapeurs de carburant provenant du compartiment moteur avant de mettre le moteur en marche. Ne jamais mettre le moteur en marche en cas de fuite d'essence ou si un branchement électrique est desserré.
REGULAR UNLEADED GASOLINE ONLY	ESSENCE NORMALE SANS PLOMB UNIQUEMENT

F3Y-U415B-10  
F3Y-U415B-30

6

<b>⚠ WARNING</b>
Do not use cleat or grips to lift PWC. PWC could fall, which could result in severe injury.
<b>⚠ AVERTISSEMENT</b>
Ne pas soulever le scooter à l'aide du taquet ou des poignées. Le scooter pourrait tomber et provoquer des blessures graves.
<b>⚠ WARNING</b>
Do not board PWC if operator is applying throttle.
<b>⚠ AVERTISSEMENT</b>
Ne pas embarquer lorsque le pilote donne des gaz.

YAMAHA

F3V-U416A-10  
F3V-U416A-30

7

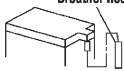
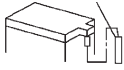
<b>⚠ WARNING</b>
Be sure to connect breather hose to battery. Fire or explosion could result if not connected properly.
Breather hose

<b>⚠ AVERTISSEMENT</b>
Bien veiller à brancher la duril de mise à l'air à la batterie. Un mauvais branchement risque d'être à l'origine d'un incendie ou d'une explosion.
Mise à l'air

YAMAHA

F0V-U41DB-12

## EX Sport

8



F3K-U41D5-30

# General and important labels

---

EJU44221

## Other labels

9

**FIRE EXTINGUISHER CONTAINER  
COMPARTIMENT DE L'EXTINCTEUR**

F1B-U41F5-11  
F1B-U41F5-21

10



11



12



13





EJU30683

The safe use and operation of this watercraft is dependent upon the use of proper riding techniques, as well as upon the common sense, good judgment, and expertise of the operator. Before using this watercraft, make sure that its use is permitted under local laws, bylaws, and regulations, and always operate the watercraft in full conformity with any requirements and limitations imposed. Every operator should know the following requirements before riding the watercraft.

- Before operating the watercraft, read this owner's/operator's manual, the Riding Practice Guide, the Riding Instruction card, and all labels on the watercraft. These materials should give you an understanding of the watercraft and its operation.
- Never allow anyone to operate this watercraft until they too have read this owner's/operator's manual, the Riding Practice Guide, the Riding Instruction card, and all labels.

EJU30743

## Limitations on who may operate the watercraft

- Make sure that the operator is 16 years of age or older and has taken a boater safety course.  
Adults must supervise use by minors.
- This watercraft is designed to carry the operator and up to 2 passengers. Never exceed the maximum load limit or allow more than 3 persons (or 2 persons if a wakeboarder or water-skier is being pulled) to ride the watercraft at any time.



Maximum load:  
220 kg (485 lb)  
Load is the total weight of cargo, operator, and passengers.

- Do not operate the watercraft with any passengers on board until you have considerable practice and experience riding alone. Operating the watercraft with passengers requires more skill. Take the time to become accustomed to the handling characteristics of the watercraft before trying any difficult maneuvers.

# Safety information

EJU44481

## Cruising limitations

- Scan constantly for people, objects, and other watercraft. Be alert for conditions that limit your visibility or block your vision of others.

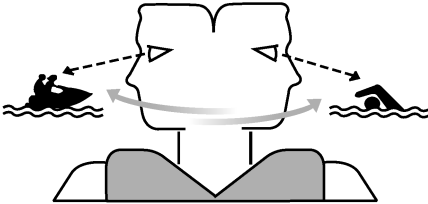

- Operate defensively at safe speeds and keep a safe distance away from people, objects, and other watercraft.
- Do not follow directly behind watercraft or other boats.
- Do not go near others to spray or splash them with water, go too close to other boats, or go too fast for the traffic conditions.
- EX / EX Sport: Take early action to avoid collisions. Remember, watercraft and other boats do not have brakes.
- EX / EX Sport: Avoid sharp turns or other maneuvers that make it hard for others to avoid you or understand where you are going.
- EX Deluxe: Take early action to avoid collisions. Remember, watercraft and other boats do not have brakes. In addition, the Reverse with Intuitive Deceleration Electronics (RiDE) system is not a braking device for avoiding dangerous situations. The RiDE system is an electronic system for controlling the engine speed and reverse gate, which is located near the jet thrust nozzle. The RiDE lever located at the left handlebar grip can be used to change the direction of the jet thrust so that the watercraft moves in reverse or is in neutral. The RiDE system assists the operator when slowing down and during slow-speed maneuvering, such as launching, beaching, and docking.
- EX Deluxe: Avoid sharp turns, slowing down rapidly by squeezing the RiDE lever forcefully, and other maneuvers that make it hard for others to avoid you or understand where you are going.
- Avoid areas with submerged objects or shallow water.
- Do not release the throttle lever when trying to steer away from objects—as with other powerboats, you need throttle to steer. Always check throttle and steering controls before starting the watercraft.
- Ride within your limits and avoid aggressive maneuvers to reduce the risk of loss of control, ejection, and collision.
- This is a high performance boat—not a toy. Avoid aggressive operation, sharp turns, and unexpected acceleration that can cause you to be thrown off. Do not jump waves or wakes—jumping can cause injuries such as back or spinal injuries (paralysis), facial injuries, and broken legs, ankles, and other bones. Improper operation can result in severe injury or death.
- Do not operate the watercraft in rough water, bad weather, or when visibility is poor; this may lead to an accident causing injury or death. Be alert to the possibility of adverse weather. Take note of weather forecasts and the prevailing weather conditions before setting out on your watercraft.
- As with any water sport, you should not operate your watercraft without someone else

nearby. If you operate further than swimming distance from shore, you should be accompanied by another boat or watercraft, but make sure you stay a safe distance away. It's good, common sense.

- Never operate in water that is less than 60 cm (2 ft) deep from the bottom of the watercraft, otherwise you increase your chance of hitting a submerged object, which could result in injury.

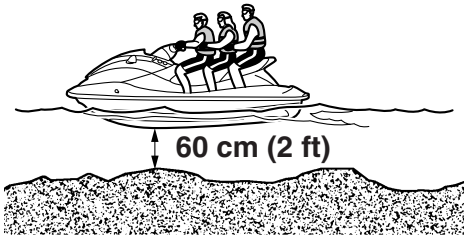

- This watercraft is not equipped with lighting required for night operation. Do not operate the watercraft after sunset or before dawn, otherwise you increase the risk of colliding with another boat, which could result in severe injury or death.

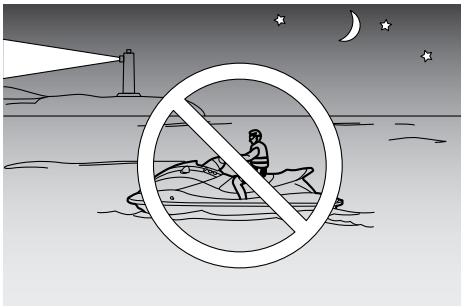

- Follow navigation rules, and state/provincial and local laws that apply to watercraft.

EJU43131

## Operation requirements

- All riders must wear a personal flotation device (PFD) that is approved by the appropriate authorities and is suitable for personal watercraft use.
- Wear protective clothing. Severe internal injuries can occur if water is forced into body cavities as a result of falling into the water or being near the jet thrust nozzle. You must wear shorts with neoprene (wetsuit material) to keep water from being forcefully injected into the rectum or vagina during a fall backward. Riders not wearing neoprene shorts have received severe rectal, vaginal, and internal injuries resulting in permanent damage. Normal swimwear does not offer adequate protection.

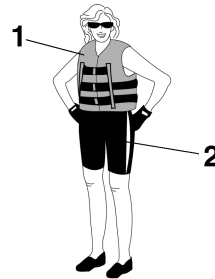

- 1 Authority-approved PFD
- 2 Wetsuit bottom

- Eye protection is recommended to keep wind, water, and glare from the sun out of your eyes while you operate your watercraft. Restraining straps for eyewear are made which are designed to float should your eyewear fall in the water. Footwear and gloves are recommended.
- You must decide whether to wear a helmet while you ride for recreation. You should know that a helmet could help protect you

## Safety information

---

in certain kinds of accidents and that it could injure you in others.

A helmet is designed to provide some head protection. Although helmets cannot protect against all foreseeable impacts, a helmet might reduce your injuries in a collision with a boat or other obstacle.

A helmet may have potential safety hazards, as well. Falling into the water could risk the chance of the helmet catching water, commonly known as “bucketing”, and the resulting strain on your neck could cause choking, severe and permanent neck injuries, or death. A helmet could also increase the risk of an accident if it reduces your vision or hearing, or if it distracts you or increases your fatigue.

How should you decide if a helmet’s potential safety benefits outweigh its potential risks for you? Consider your particular riding conditions. Consider factors such as your riding environment and your riding style and ability. Also consider the likelihood of traffic congestion, and the water surface conditions.

If you decide to wear a helmet based upon your riding circumstances, choose one carefully. Look for a helmet designed for personal watercraft use, if possible. If you will be engaging in closed-course competition, follow the helmet requirements of the sanctioning organization.

- Never operate the watercraft after consuming alcohol or taking other drugs.
- For reasons of safety and proper care of the watercraft, always perform the pre-operation checks listed on page 52 before operating the watercraft.
- The operator should grip the handlebars firmly with both hands and the passengers should hold on firmly, either to the person

in front of them or to the handgrip provided.

- The operator and passengers should always keep their feet on the floor of the footwell when the watercraft is in motion. Lifting your feet increases the chances of losing your balance, or hitting objects outside the watercraft with your feet. Do not give a ride to children if their feet cannot reach the floor of the footwell.



- Never allow a passenger to ride in front of the operator.
- Always consult your doctor on whether it is safe for you to ride this watercraft if you are pregnant or in poor health.
- Do not attempt to modify this watercraft. Modifications to your watercraft may reduce safety and reliability, and render the watercraft unsafe or illegal for use.
- Attach the engine shut-off cord (lanyard) to your left wrist and keep it free from the handlebars so that the engine stops if you, the operator, fall off. After riding, remove the engine shut-off cord (lanyard) from the wa-

tercraft to avoid accidental starting or unauthorized use by children or others.

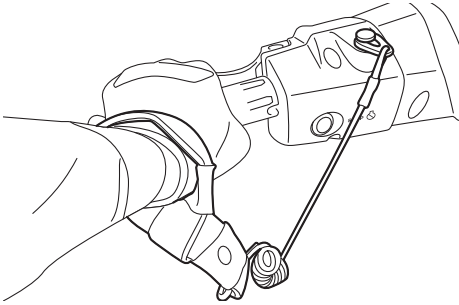

- Scan carefully for swimmers and stay away from swimming areas. Swimmers are hard to see and you could accidentally hit someone in the water.
- Avoid being hit by another boat. You should always take the responsibility to watch for traffic; other boaters may not be watching for you. If they do not see you, or if you maneuver more quickly than other boaters expect, you risk a collision.
- Maintain a safe distance from other boats and watercraft, and also watch for ski ropes or fishing lines. Obey the “Safe boating rules” and be sure to check behind you before making a turn or slowing down. (See “Safe boating rules” on page 18.)

EJU30841

## Recommended equipment

The following items should be carried on board your watercraft:

- Sound-signaling device  
You should carry a whistle or other sound-signaling device that can be used to signal other boats.
- Visual distress signals  
It is recommended that a pyrotechnic device, which is approved by the appropriate authorities, be stored in a waterproof container on your watercraft. A mirror can also be used as an emergency signal. Contact a Yamaha dealer for more information.
- Watch  
A watch is helpful so you will know how long you have been operating the watercraft.
- Towline  
A towline can be used to tow a disabled watercraft in an emergency.

# Safety information

---

EJU44610

## Hazard information

- Never start the engine or let it run for any length of time in an enclosed area. Exhaust fumes contain carbon monoxide, a colorless, odorless gas that may cause loss of consciousness and death within a short time. Always operate the watercraft in an open area.
- Do not touch the hot oil tank, muffler, or engine during or immediately after engine operation; they can cause serious burns.
- Do not place magnets or objects with a strong magnetic force near the throttle lever or RiDE lever (EX Deluxe). The electronic throttle mechanism of the levers can be adversely affected, which could cause loss of control. In addition, do not place objects susceptible to magnetic forces (i.e., credit cards, watches, etc.) close to the throttle lever or RiDE lever.

EJU44341

## Watercraft characteristics

- Jet thrust turns the watercraft. Releasing the throttle lever completely produces only minimum thrust. If you are traveling at speeds above trolling, you will have rapidly decreasing ability to steer without throttle. This model is equipped with the Yamaha Engine Management System (YEMS) that includes an off-throttle steering (OTS) system. It will activate at planing speeds should you attempt to steer the watercraft after releasing the throttle lever. The OTS system assists in turning by continuing to supply some thrust while the watercraft is decelerating, but you can turn more sharply if you apply throttle while turning the handlebars.

The OTS system does not function below planing speeds or when the engine is off. Once the engine slows down, the watercraft will no longer turn in response to handlebar input until you apply throttle again or you reach trolling speed.

Practice turning in an open area without obstacles until you have a good feel for this maneuver.
- EX: This watercraft is water-jet propelled. The jet pump is directly connected to the engine. This means that jet thrust will produce some movement whenever the engine is running. There is no “neutral” position.
- EX Sport: This watercraft is water-jet propelled. The jet pump is directly connected to the engine. This means that jet thrust will produce some movement whenever the engine is running. There is no “neutral” position. You are in either “forward” or “reverse”, depending upon the shift lever position.

## Safety information

- **EX Sport:** Do not use the reverse function to slow down or stop the watercraft as it could cause you to lose control, be ejected, or impact the handlebars. This could increase the risk of back/spinal injury (paralysis), facial injuries, and broken legs, ankles, and other bones. You could also damage the shift mechanism.
- **EX Sport:** Reverse can be used to slow down or stop during slow-speed maneuvering, such as when docking. Once the engine is idling, shift into reverse and gradually increase engine speed. Make sure that there are no obstacles or people behind you before shifting into reverse.
- **EX Deluxe:** This watercraft is water-jet propelled. The jet pump is directly connected to the engine. This means that jet thrust will produce some movement whenever the engine is running and the “F” (forward) or “R” (reverse) shift indicator is displayed. When the “N” (neutral) shift indicator is displayed, the forward and reverse thrust are balanced to help keep the watercraft from moving in either direction, although some movement may occur.

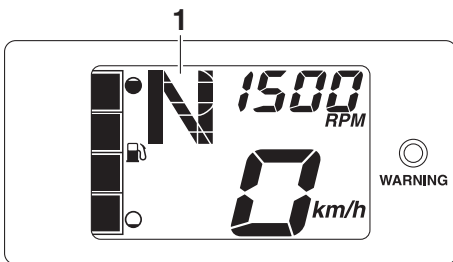

1 “N” (Neutral position)

- **EX Deluxe:** To avoid rear-end collisions while operating the watercraft, check behind you before using the RiDE lever to slow down or stop the watercraft. Make

- sure that there are no obstacles or people behind you before shifting into reverse.
- Keep away from the intake grate while the engine is on. Items such as long hair, loose clothing, or PFD straps can become entangled in moving parts, resulting in severe injury or drowning.
- Never insert any object into the jet thrust nozzle while the engine is running. Severe injury or death could result from coming in contact with the rotating parts of the jet pump.

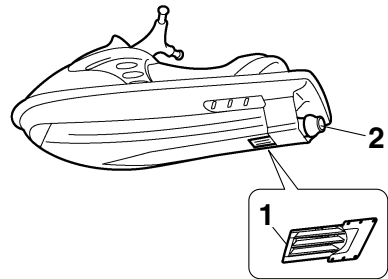

- 1 Intake grate
- 2 Jet thrust nozzle

- Stop the engine and remove the clip from the engine shut-off switch before removing any debris or weeds, which may have collected around the jet intake.

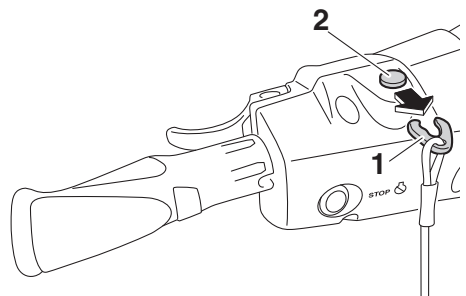

- 1 Clip
- 2 Engine shut-off switch

# Safety information

EJU30957

## Wakeboarding and water-skiing

You can use the watercraft for wakeboarding or water-skiing if it has the seating capacity to carry the operator, a rearward-facing spotter, and the wakeboarder or water-skier when he or she is not being pulled.

The watercraft must also have a cleat designed to pull a ski rope; do not attach the rope to any other location.

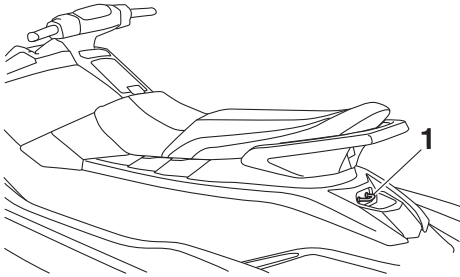

1 Cleat

It is the watercraft operator's responsibility to be alert to the safety of the wakeboarder or water-skier and others. Know and follow all local regulations in effect for the waters in which you will be operating.

The operator should be comfortable carrying passengers before attempting to pull a wakeboarder or water-skier.

The following are some important considerations for minimizing risks while pulling a wakeboarder or water-skier.

- The wakeboarder or water-skier should wear an approved PFD, preferably a brightly colored one so boat operators can see the person being pulled.
- The wakeboarder or water-skier should wear protective clothing. Severe internal injuries can occur if water is forced into body cavities as a result of falling into the water.

Normal swimwear does not adequately protect against forceful water entry into the rectum or vagina. The person being pulled should wear a wetsuit bottom or clothing that provides equivalent protection.

- A second person should be on board as a spotter to watch the wakeboarder or water-skier; in many places it is required by law. Let the person being pulled direct the operator's control of speed and direction with hand signals.

The spotter should sit astride the rear of the seat and hold onto the handgrip with both feet firmly on the floor of the footwell for proper balance while facing to the rear to watch the wakeboarder's or water-skier's hand signals and condition.

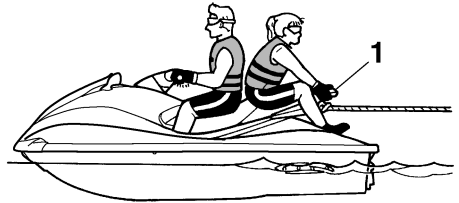

1 Handgrip

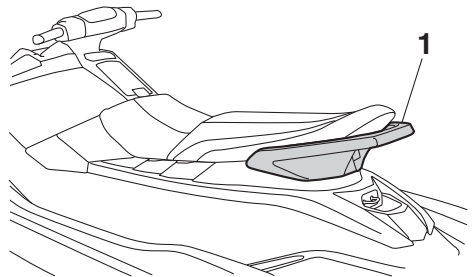

1 Handgrip

- Your control while pulling a wakeboarder or water-skier is affected by the wakeboard-



er's or water-skier's ability, as well as water and weather conditions.

- When preparing to pull a wakeboarder or water-skier, operate the watercraft at the slowest possible speed until the watercraft is well away from the person being pulled and slack in the ski rope is taken up. Make sure that the rope is not looped around anything.

After checking that the wakeboarder or water-skier is ready and that there is no traffic or other obstacles, apply enough throttle to raise the person.

- Make smooth, wide turns. The watercraft is capable of very sharp turns, which could exceed the abilities of the wakeboarder or water-skier. Keep the person being towed at least 50 m (164 ft), about twice the distance of a standard ski rope, away from any potential hazard.
- The operators of boats and other watercraft may not be aware that you are pulling a wakeboarder or water-skier. Together with the spotter, pay attention to others around you and cruise at safe speeds.
- Be alert to the hazard of the ski rope handle snapping back at the watercraft when the wakeboarder or water-skier falls or is unable to get up.
- Towing heavy or bulky objects other than wakeboarders or water-skiers, such as another boat or watercraft, can cause loss of steering control and create a hazardous condition. If you must tow another boat in an emergency situation, operate slowly and cautiously.

EJU30971

## Safe boating rules

Your Yamaha watercraft is legally considered a powerboat. Operation of the watercraft must be in accordance with the rules and regulations governing the waterway on which it is used.

# Safety information

---

EJU30992

## **Enjoy your watercraft responsibly**

You share the areas you enjoy when riding your watercraft with others and with nature. So your enjoyment includes a responsibility to treat these other people, and the lands, waters, and wildlife with respect and courtesy.

Whenever and wherever you ride, think of yourself as the guest of those around you. Remember, for example, that the sound of your watercraft may be music to you, but it could be just noise to others. And the exciting splash of your wake can make waves others won't enjoy.

Avoid riding close to shoreline homes and waterfowl nesting areas or other wildlife areas, and keep a respectful distance from fishermen, other boats, swimmers, and populated beaches. When travel in areas like these is unavoidable, ride slowly and obey all laws.

Proper maintenance is necessary to ensure that the exhaust emission and sound levels of your watercraft will continue to be within regulated limits. You have the responsibility to make sure that the recommended maintenance in this owner's/operator's manual is carried out.

Remember, pollution can be harmful to the environment. Do not refuel or add oil where a spill could cause damage to nature. Remove your watercraft from the water and move it away from the shoreline before refueling. Dispose of water and any fuel and oil residue in the engine compartment according to local regulations. And keep your surroundings pleasant for the people and wildlife that share the waterways: don't litter.

When you ride responsibly, with respect and courtesy for others, you help ensure that our waterways stay open for the enjoyment of a variety of recreational opportunities.

EJU43331

## Watercraft glossary

### **Trolling speed**

“Trolling” is the lowest maneuvering speed. You are applying little or no throttle. The watercraft is down in the water, and there is no wake.

### **Sub-planing speed**

“Sub-planing” is a medium speed. The bow of the watercraft is slightly up from the water surface, but you are still traveling through the water. There is a wake.

### **Planing speed**

“Planing” is a faster speed. The watercraft is more level and is skimming on top of the water. There is a wake.

### **Bow**

The front end of the watercraft.

### **Stern**

The rear end of the watercraft.

### **Starboard**

The right side of the watercraft when facing forward.

### **Port**

The left side of the watercraft when facing forward.

### **Bilge water**

Water that has collected in the engine compartment.

### **Yamaha Engine Management System (YEMS)**

YEMS is an integrated, computerized management system that controls and adjusts ignition timing, fuel injection, engine diagnostics, and the off-throttle steering (OTS) system.

### **Reverse with Intuitive Deceleration Electronics (RiDE)**

RiDE is an electronic system that controls the reverse, neutral, and deceleration operations of the watercraft.

# Description

EJU31012

## Location of main components

### Exterior

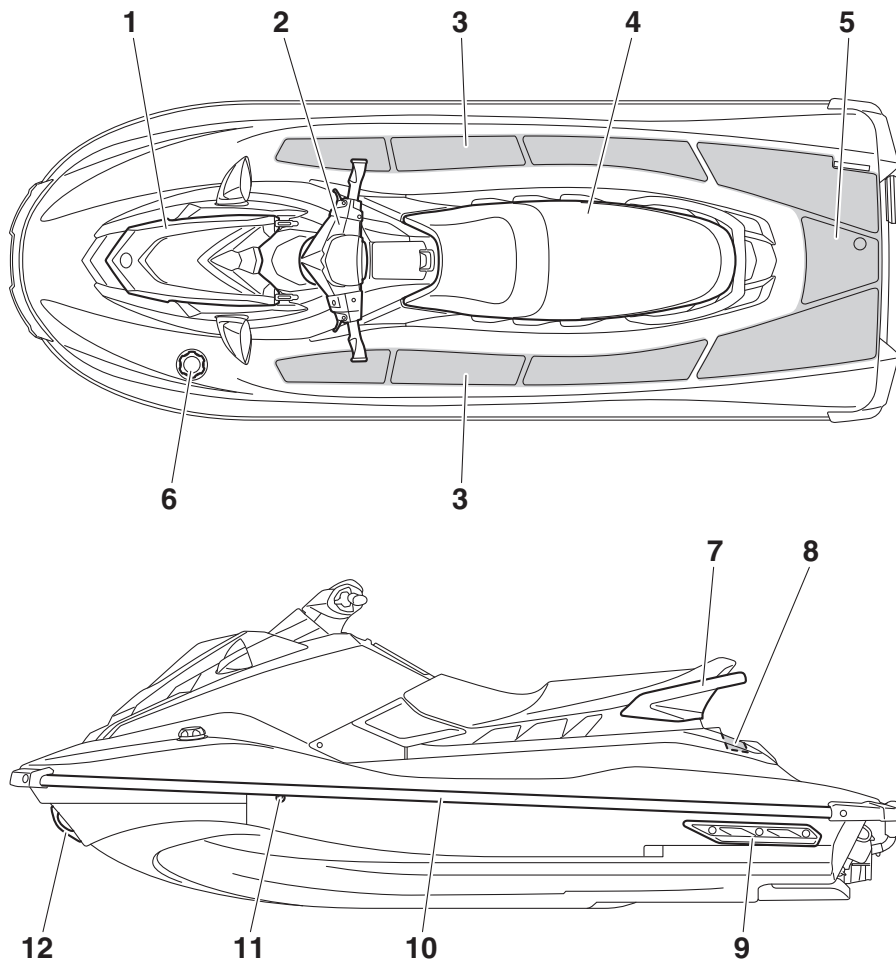

- |                             |   |
|-----------------------------|---|
| 1 Hood                      | 9 Sponson                               |
| 2 Handlebar                 | 10 Gunwale                              |
| 3 Footwell                  | 11 Cooling water pilot outlet (page 27) |
| 4 Seat (page 38)            | 12 Bow eye (page 40)                    |
| 5 Boarding platform         |   |
| 6 Fuel filler cap (page 44) |   |
| 7 Handgrip (page 38)        |   |
| 8 Reboarding grip (page 39) |   |

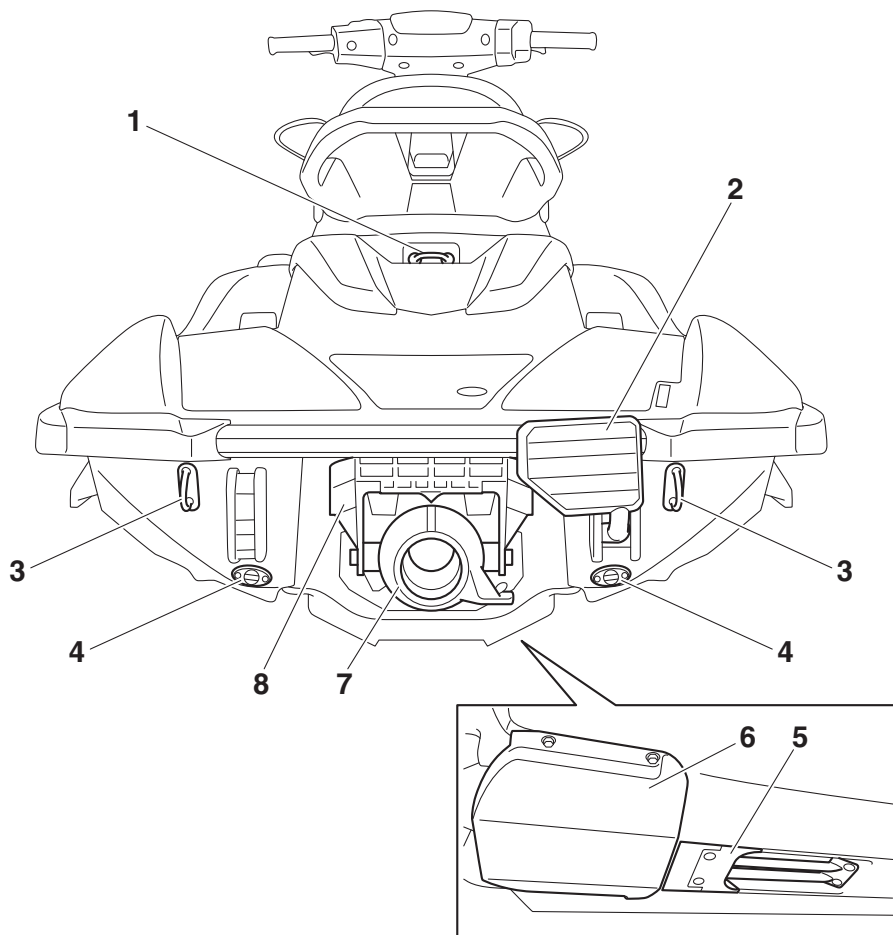

- 1 Cleat (page 40)
- 2 Reboarding step (EX Sport / EX Deluxe)  
(page 39)
- 3 Stern eye (page 40)
- 4 Stern drain plug (page 48)
- 5 Intake grate
- 6 Ride plate
- 7 Jet thrust nozzle
- 8 Reverse gate (EX Sport / EX Deluxe) (page 29)

# Description

## EX Deluxe

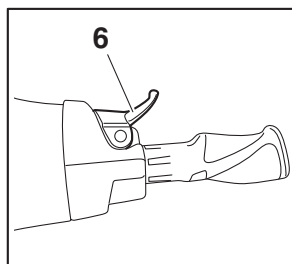
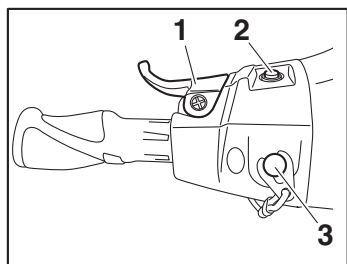

## EX / EX Sport

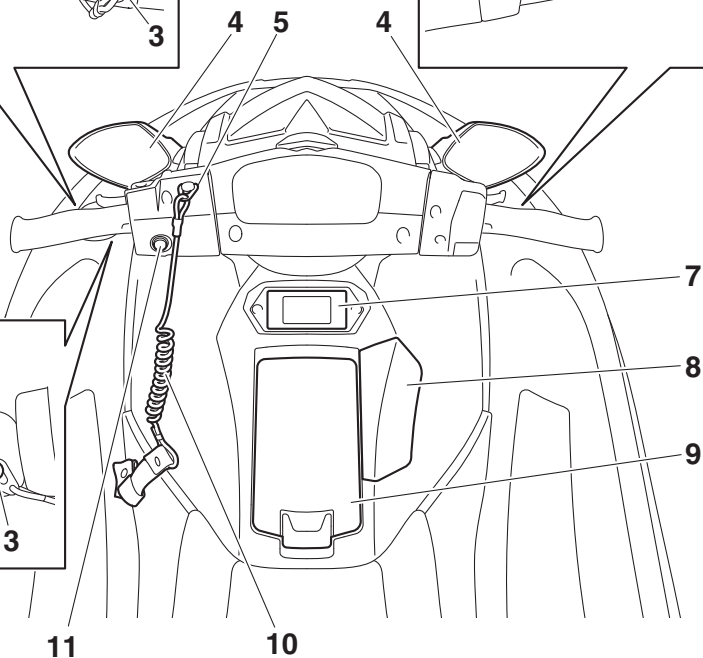
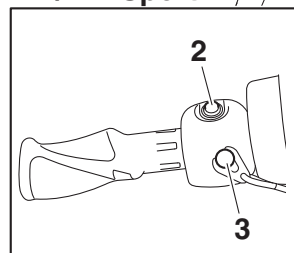

- 1 RiDE lever (EX Deluxe) (page 29)
- 2 Start switch (page 25)
- 3 Engine shut-off switch (page 25)
- 4 Rearview mirror (EX Sport / EX Deluxe)
- 5 Clip (page 25)
- 6 Throttle lever (page 26)
- 7 Multifunction information center (page 33)
- 8 Shift lever (EX Sport) (page 29)
- 9 Glove compartment (page 41)
- 10 Engine shut-off cord (lanyard) (page 25)
- 11 Engine stop switch (page 25)

## Engine compartment

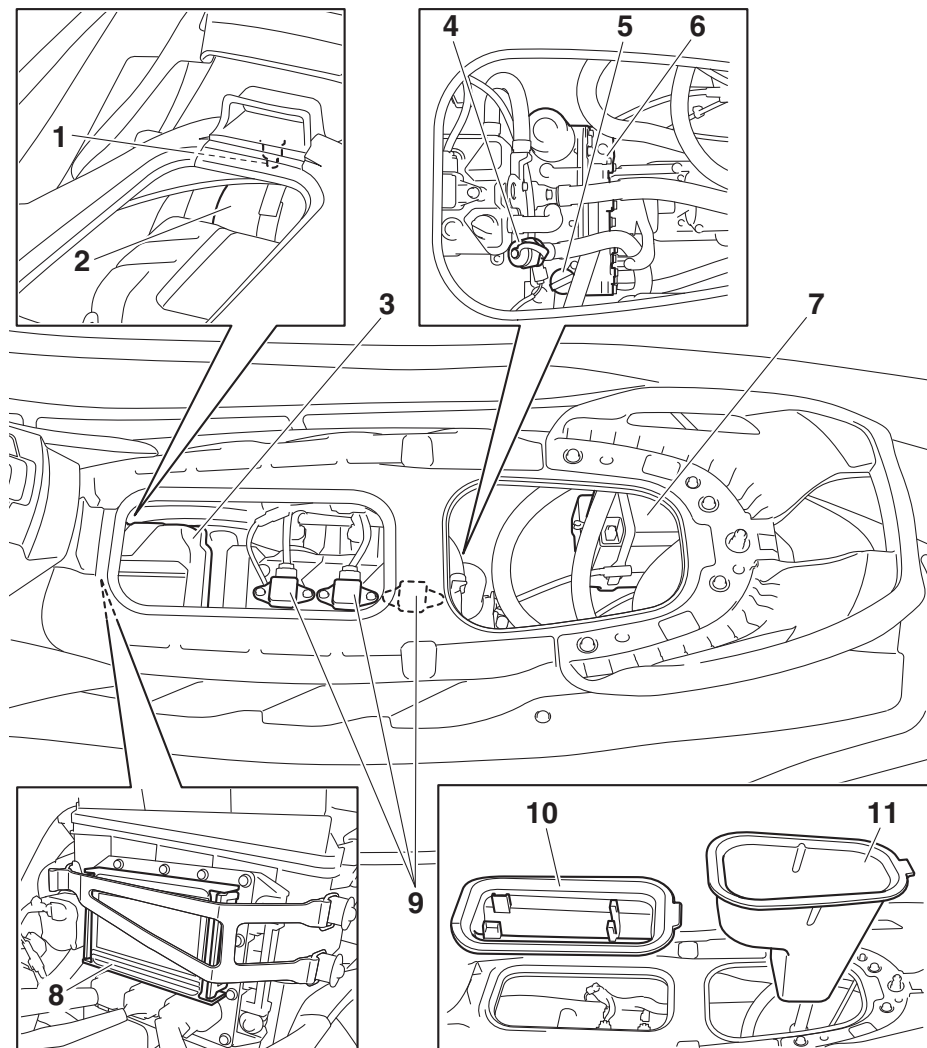

1 Water separator (page 27)

2 Fuel tank

3 Air filter case

4 Flushing hose connector (page 76)

5 Oil tank filler cap/Dipstick (page 46)

6 Oil tank

7 Battery (page 55)

8 Fuse box

9 Spark plug/Ignition coil (page 43)

10 Fire extinguisher holder (page 43)

11 Seat storage compartment (page 42)

# Control function operation

EJU31026

## Watercraft control functions

EJU31153

### Engine stop switch “”

The engine stop switch (red button) stops the engine when the switch is pushed.

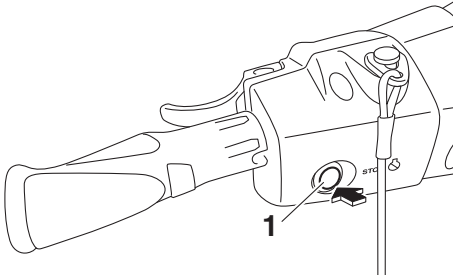

1 Engine stop switch

EJU31164

### Engine shut-off switch “”

The engine shut-off switch automatically stops the engine when the clip, on the end of the engine shut-off cord (lanyard), is removed from the switch, such as if the operator falls off the watercraft.

Insert the clip under the engine shut-off switch before starting the engine.

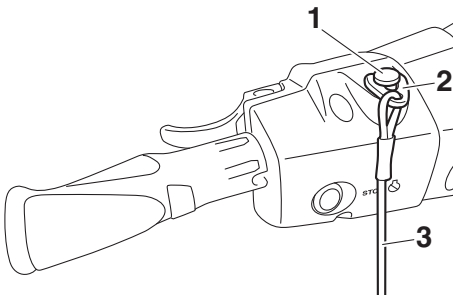

- 1 Engine shut-off switch
- 2 Clip
- 3 Engine shut-off cord (lanyard)

When the engine is not running, remove the clip from the engine shut-off switch to pre-

vent accidental starting or unauthorized operation by children or others.

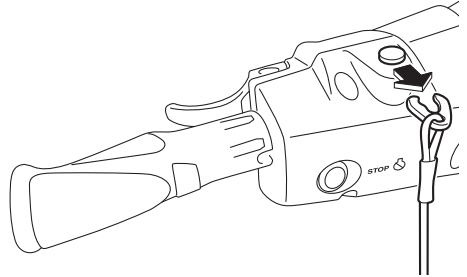

EJU44350

### Start switch “”

ECJ01311

#### **NOTICE**

**Do not run the engine over 4000 r/min on land. Also, do not run the engine for more than 15 seconds without supplying water, otherwise the engine could overheat.**

The start switch (green button) starts the engine when the switch is pushed.

Release the start switch as soon as the engine starts to run. If the engine does not start in 5 seconds, release the start switch, wait 15 seconds, and then try again. **NOTICE: Never push the start switch while the engine is running. Do not operate the start switch for more than 5 seconds, otherwise the battery will be discharged and the engine**



# Control function operation

**will not start. Also, the starter motor could be damaged.** [ECJ01041]

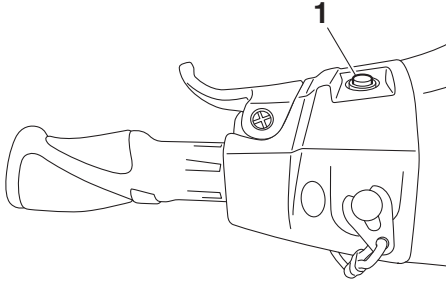

1 Start switch

The engine will not start under any of the following conditions:

- Clip is removed from the engine shut-off switch.
- Throttle lever is squeezed.
- Throttle lever is malfunctioning.
- EX Deluxe: RiDE lever is squeezed.
- EX Deluxe: RiDE lever is malfunctioning.

EJU31212

## Throttle lever

The throttle lever increases the engine speed when the lever is squeezed.

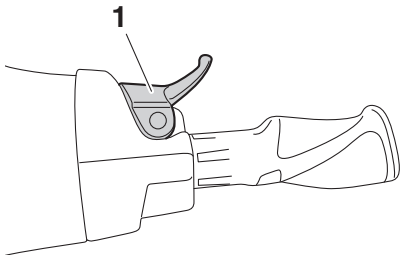

1 Throttle lever

The throttle lever returns automatically to its fully closed (idle) position when released.

EJU43342

## RiDE lever (EX Deluxe)

When the RiDE lever is squeezed, the reverse gate lowers and the watercraft starts moving

in reverse. If the watercraft is moving forward, the watercraft gradually slows down until it stops, and then the watercraft starts moving in reverse.

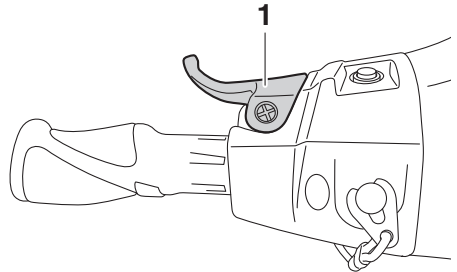

1 RiDE lever

When the RiDE lever is released, it automatically returns to its fully closed (idle) position and the reverse gate moves to the neutral position.

EJU31262

## Steering system

By turning the handlebars in the direction you wish to travel, the angle of the jet thrust nozzle

# Control function operation

zle is changed, and the direction of the watercraft is changed accordingly.

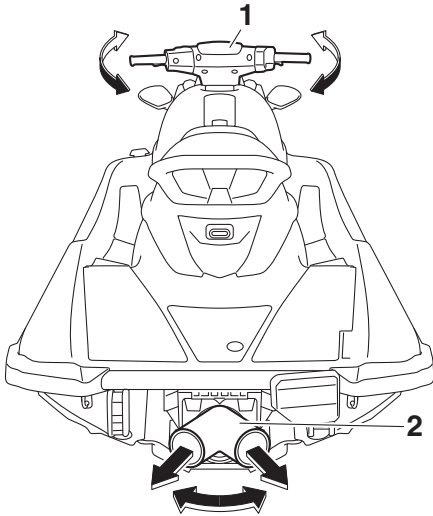

- 1 Handlebar
- 2 Jet thrust nozzle

Since the strength of the jet thrust determines the speed and degree of a turn, throttle must always be applied when attempting a turn, except at trolling speed.

This model is equipped with the Yamaha Engine Management System (YEMS) that includes an off-throttle steering (OTS) system. It will activate at planing speeds should you attempt to steer the watercraft after releasing the throttle lever. The OTS system assists in turning by continuing to supply some thrust while the watercraft is decelerating, but you can turn more sharply if you apply throttle while turning the handlebars. The OTS system does not function below planing speeds or when the engine is off. Once the engine slows down, the watercraft will no longer turn in response to handlebar input until you apply throttle again or you reach trolling speed.

EJU35975

## Cooling water pilot outlet

When the engine is running, some of the cooling water that is circulated in the engine is discharged from the cooling water pilot outlet.

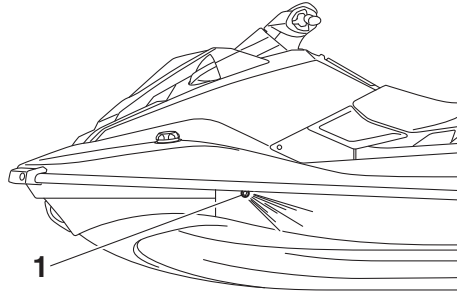

- 1 Cooling water pilot outlet

There is a cooling water pilot outlet on the port (left) side of the watercraft. To check for proper operation of the cooling system, make sure that water is being discharged from the cooling water pilot outlet. If water is not being discharged from the outlet, stop the engine and check the jet intake for clogging. (See page 91 for information on the jet intake.)

### TIP:

- It will take about 60 seconds for the water to reach the outlet after the engine is started.
- Water discharge may not be constant when the engine is running at idling speed. If this occurs, apply a little throttle to make sure that water discharges properly.

EJU40323

## Water separator

The water separator prevents water from entering the fuel tank by collecting any water that has entered the fuel tank breather hose if the watercraft was capsized.

# Control function operation

---

If water has collected in the water separator, drain it by loosening the drain screw.

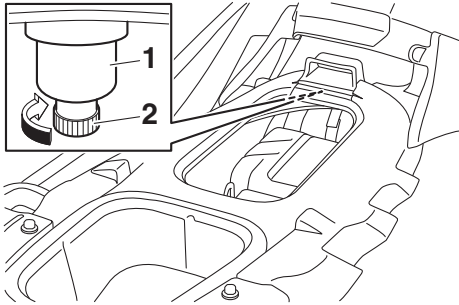

- 1 Water separator
- 2 Drain screw

To drain water from the water separator:

- (1) Place a drain pan or dry cloth under the water separator.
- (2) Gradually loosen the drain screw to drain the water. Catch the draining water in the drain pan or soak it up with the dry cloth so that it does not spill into the engine compartment. If any water spills into the watercraft, be sure to wipe it up with a dry cloth.
- (3) Securely tighten the drain screw until it stops.

# Watercraft operation

EJU40014

## Watercraft operation functions

EJU40522

### Reverse system (EX Sport)

EWJ01231

#### **! WARNING**

- Do not use the reverse function to slow down or stop the watercraft as it could cause you to lose control, be ejected, or impact the handlebars.
- Make sure that there are no obstacles or people behind you before shifting into reverse.
- Do not touch the reverse gate while the shift lever is being operated, otherwise you could be pinched.

When the shift lever is moved to the reverse position, the reverse gate lowers and deflects the water jet being discharged from the jet thrust nozzle. This allows the watercraft to move in reverse.

#### To shift into reverse:

- (1) Release the throttle lever and let the engine speed return to idle.
- (2) Pull the shift lever rearward until it stops in the reverse position. The reverse gate

will lower and the watercraft will start moving in reverse at trolling speed.

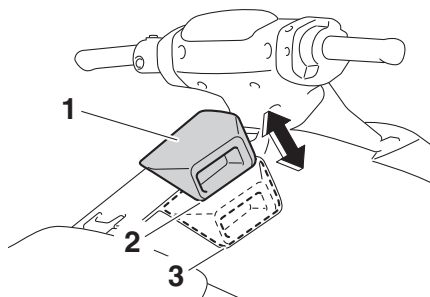

- 1 Shift lever
- 2 Reverse position
- 3 Forward position

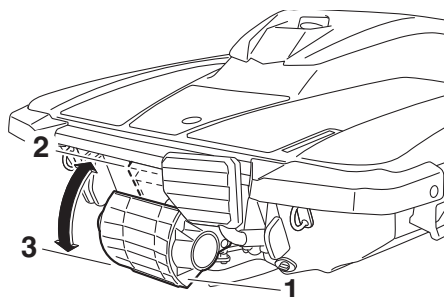

- 1 Reverse gate
- 2 Forward position
- 3 Reverse position

#### To shift into forward:

- (1) Release the throttle lever and let the engine speed return to idle.
- (2) Push the shift lever forward until it stops in the forward position. The reverse gate will rise and the watercraft will start moving forward at trolling speed.

EJU43154

### Shift system (EX Deluxe)

EWJ01773

#### **! WARNING**

- Make sure that there are no obstacles or people behind you before shifting into reverse.

# Watercraft operation

- Do not touch the reverse gate while the RiDE lever is being operated, otherwise you could be pinched.
- If the RiDE lever and throttle lever are being operated at the same time, do not release only the RiDE lever. Otherwise, the watercraft could accelerate more quickly than expected, which may lead to an accident.

The RiDE lever and throttle lever can be operated to change the forward or rearward movement of the watercraft only when the engine is running. When the RiDE lever is squeezed, the reverse gate lowers and deflects the water jet being discharged from the jet thrust nozzle so that the watercraft moves in reverse or is in neutral. When the throttle lever is squeezed, the reverse gate rises and the watercraft moves forward.

## TIP:

- This model is equipped with a function which limits the engine speed in reverse.
- When the engine is started, the reverse gate automatically moves to the neutral position.

## To shift into reverse:

- (1) Release the throttle lever.
- (2) Squeeze the RiDE lever. The reverse gate will lower, the engine speed will increase, the watercraft will start moving in

reverse, and the “R” (reverse) shift indicator will be displayed.

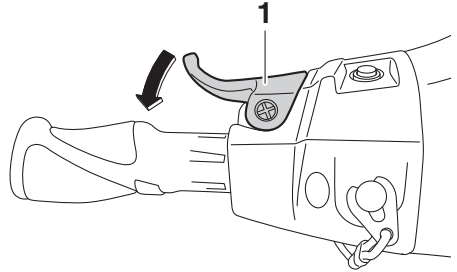

1 RiDE lever

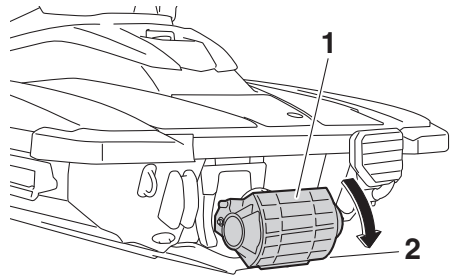

1 Reverse gate

2 Reverse position

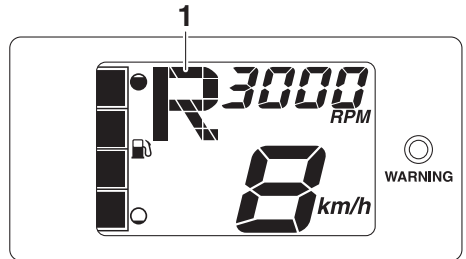

1 “R” (Reverse position)

## To shift into neutral from reverse:

Release the RiDE lever. The reverse gate will automatically return to the neutral position

# Watercraft operation

and the “N” (neutral) shift indicator will be displayed.

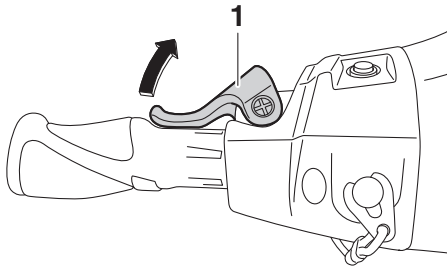

1 RiDE lever

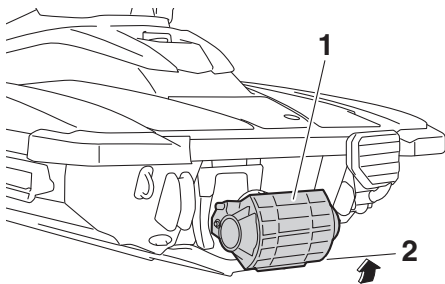

1 Reverse gate  
2 Neutral position

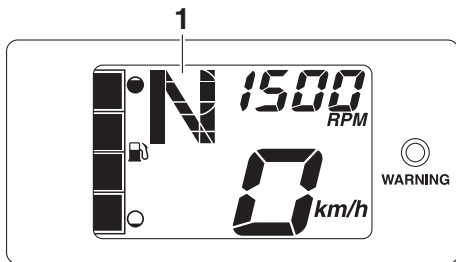

1 “N” (Neutral position)

## TIP:

Although the neutral position helps keep the watercraft from moving even when the engine is running, some movement may occur.

## To shift into forward:

- (1) Release the RiDE lever.
- (2) Squeeze the throttle lever. The reverse gate will rise completely, the engine speed will increase, the watercraft will start moving forward, and the “F” (forward) shift indicator will be displayed.

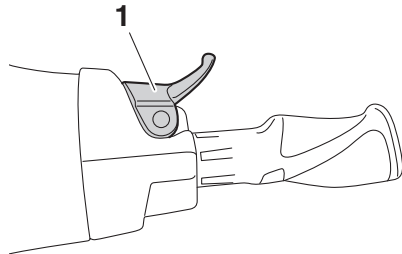

1 Throttle lever

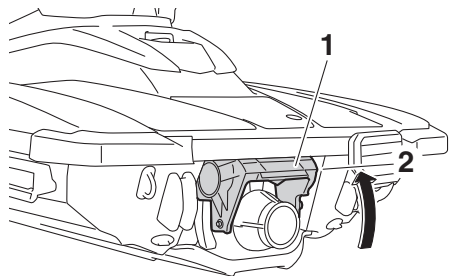

1 Reverse gate  
2 Forward position

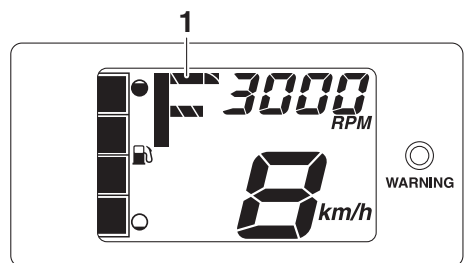

1 “F” (Forward position)

# Watercraft operation

## TIP:

If the RiDE lever is squeezed while the throttle lever is squeezed, the watercraft will slow down, and once stopped, move in reverse.

To shift into neutral from forward:

- (1) Release the throttle lever.
- (2) Lightly squeeze and release the RiDE lever. The “N” (neutral) shift indicator will be displayed.

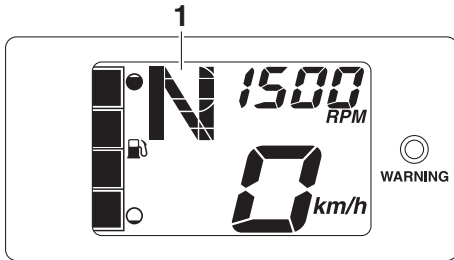
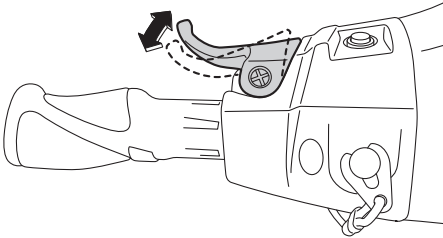

1 “N” (Neutral position)

## TIP:

If the RiDE lever is squeezed continuously, the reverse gate will move to the reverse position.

# Instrument operation

EJU44570

## Multifunction information center

The multifunction information center displays various watercraft information.

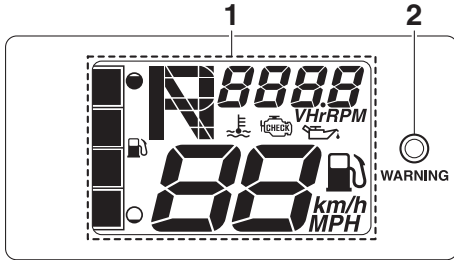

- 1 Information display
- 2 "WARNING" indicator light

### Multifunction information center initial operation

When the multifunction information center is activated, all of the display segments come on. After 2 seconds, the warning indicators in the information display go off, and then the center starts to operate normally.

### Multifunction information center standby state

If the multifunction information center does not receive any operation input within 30 seconds after the engine stops, the center will turn off and enter a standby state. When the engine is started again, the displays return to their state before the center turned off, and then the center starts to operate normally.

EJU35027

## Information display

The information display shows watercraft operating conditions.

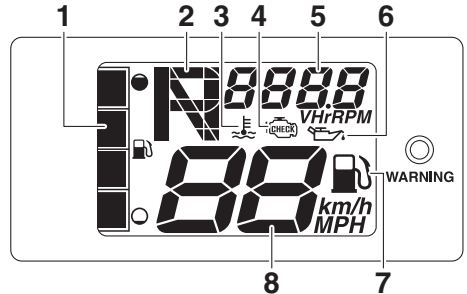

- 1 Fuel level meter
- 2 Shift indicator (EX Deluxe)
- 3 Engine overheat warning indicator
- 4 Check engine warning indicator
- 5 Tachometer / hour meter / voltmeter
- 6 Oil pressure warning indicator
- 7 Fuel level warning indicator
- 8 Speedometer

EJU43832

## Speedometer

The speedometer shows the watercraft speed against water.

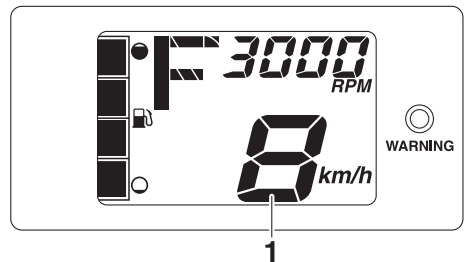

- 1 Speedometer

By switching the display units, the speed can be shown in kilometers per hour "km/h" or miles per hour "MPH".

### TIP:

"MPH" is selected as the display unit at the Yamaha factory.



# Instrument operation

## To switch the speedometer display units:

Start the engine, stop the engine, and then push the engine stop switch 3 times, pushing the switch for 0.4 seconds or more each time, before the multifunction information center turns off. The speedometer display units change.

To switch the speedometer display units again, repeat this procedure.

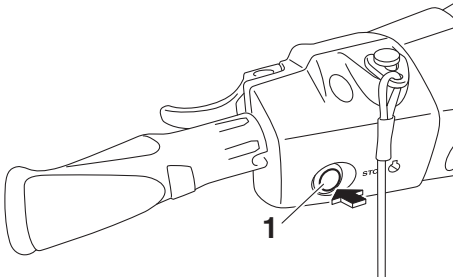

1 Engine stop switch

EJU44650

## Tachometer

The tachometer shows the engine speed.

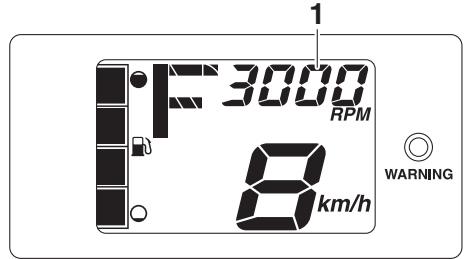

1 Tachometer

## TIP:

While the engine is stopped, the battery voltage and the total engine hours are displayed alternately.

EJU43891

## Shift indicator (EX Deluxe)

This indicator shows the reverse gate shift positions: "F" (forward), "N" (neutral), and "R" (reverse). (See page 29 for shifting procedures.)

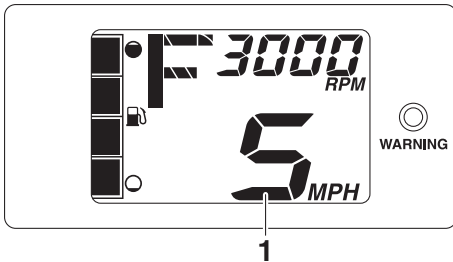

1 Speedometer

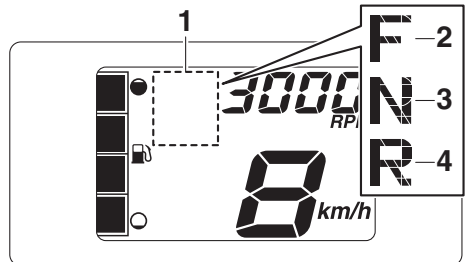

- 1 Shift indicator
- 2 "F" (Forward position)
- 3 "N" (Neutral position)
- 4 "R" (Reverse position)

EJU44700

## Hour meter and voltmeter

The hour meter and voltmeter are displayed in the tachometer portion of the information display while the engine is stopped.

# Instrument operation

The hour meter and voltmeter are displayed alternately at 3-second intervals.

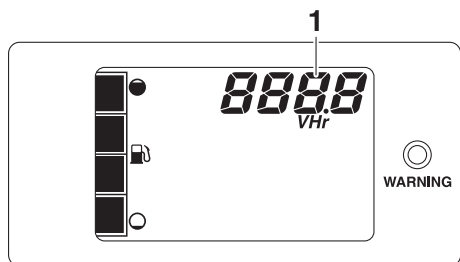

1 Hour meter and voltmeter

## TIP:

If the engine is stopped after the check engine warning is activated, the hour meter and error code will be displayed alternately at 3-second intervals.

## Hour meter

The hour meter shows the total number of hours that the engine has been running since the watercraft was new.

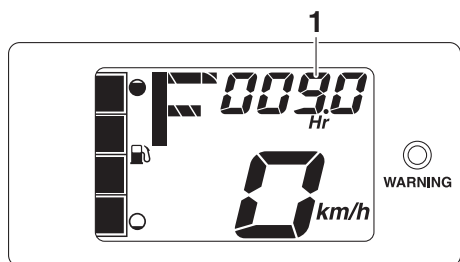

1 Hour meter

## TIP:

The elapsed time will be kept even if the battery terminals have been disconnected.

## Voltmeter

The voltmeter shows the battery voltage. When the battery voltage is normal, the voltmeter displays approximately 12 volts.

If the battery voltage has dropped significantly, "Lo" is displayed on the voltmeter, and all other display segments of the information display turn off. If the battery voltage has risen significantly, "HI" is displayed. If "Lo" or "HI" is displayed, immediately return to shore and have a Yamaha dealer service the watercraft.

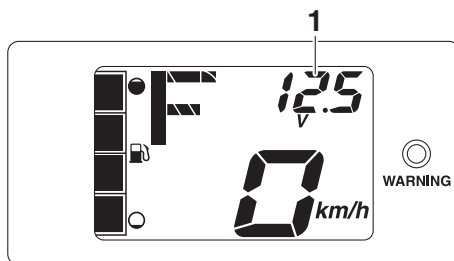

1 Voltmeter

EJU37272

## Fuel level meter

The fuel level meter shows the amount of fuel remaining in the fuel tank. The amount of remaining fuel is shown using four display segments, which disappear one at a time as the fuel level decreases.

## TIP:

The accuracy of the fuel level meter varies depending on the operating conditions. Use this function as a reference only.

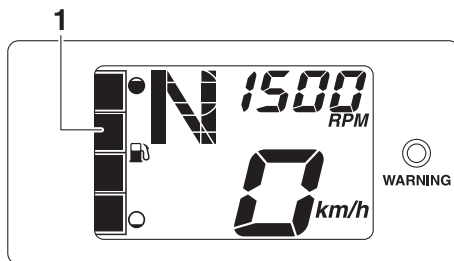

1 Fuel level meter

# Instrument operation

EJU44710

## Fuel level warning

If the fuel remaining in the fuel tank drops to about 8 L (2.1 US gal, 1.8 Imp.gal), the lowest fuel level segment, the fuel level warning indicator, and the “WARNING” indicator light blink, and the buzzer sounds intermittently for 30 seconds.

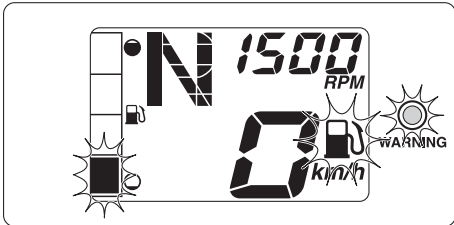

If the fuel level warning is activated, refill the fuel tank as soon as possible. (See page 44 for information on filling the fuel tank.)

After the fuel tank is refilled, the warning signals will be cleared when the engine is restarted.

EJU43720

## Oil pressure warning

If the oil pressure drops significantly, the oil pressure warning indicator, the check engine warning indicator, and the “WARNING” indicator light blink, and the buzzer sounds intermittently for 30 seconds. At the same time, the maximum engine speed is limited.

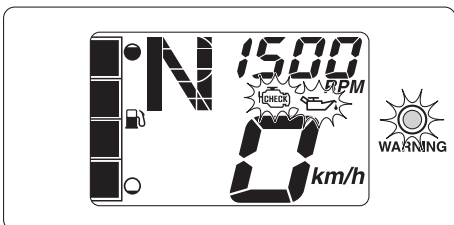

If the oil pressure warning is activated, immediately reduce the engine speed, return to shore, and then check the engine oil level. (See page 46 for information on checking the engine oil level.) If the oil level is sufficient, have a Yamaha dealer check the watercraft.

EJU43901

## Engine overheat warning

If the engine temperature rises significantly, the engine overheat warning indicator, the check engine warning indicator, and the “WARNING” indicator light blink, and the buzzer sounds intermittently. After 5 seconds, the engine overheat warning indicator and the “WARNING” indicator light stop blinking and remain on, and the buzzer sounds continuously. After 30 seconds, the buzzer stops. While the engine overheat warning is activated, the maximum engine speed is limited.

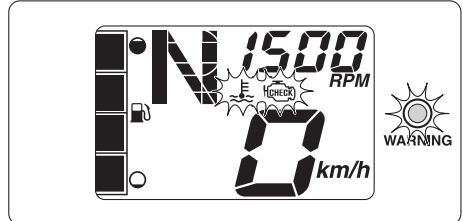

If the engine overheat warning is activated, immediately reduce the engine speed, return to shore, and then make sure that water is being discharged from the cooling water pilot outlet while the engine is running. If there is no discharge of water, stop the engine, and then check the jet intake for clogging. (See page 91 for information on the jet intake.) **NOTICE:** If you cannot locate and correct the cause of the overheating, consult a Yamaha dealer. Continuing to operate at

# Instrument operation

higher speeds could result in severe engine damage. [EC.J00042]

the hour meter and error code alternately at 3-second intervals.

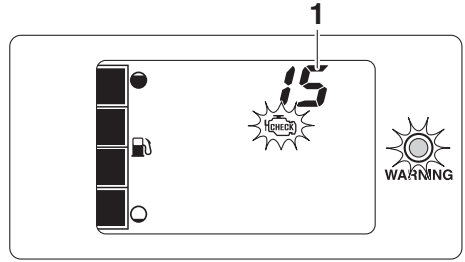
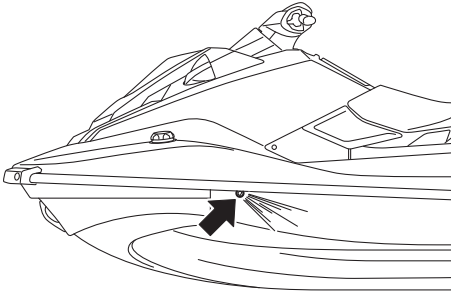

EJU44690

## Check engine warning

If a sensor malfunction or a short circuit is detected, the check engine warning indicator and the “WARNING” indicator light blink, and the buzzer sounds intermittently for 30 seconds.

## 1 Error code

If the check engine warning is activated, immediately reduce the engine speed, return to shore, and have a Yamaha dealer check the engine.

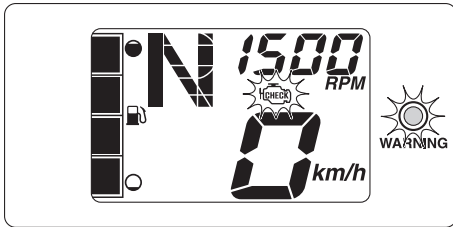

If the engine is stopped after the check engine warning is activated, the tachometer portion of the information display will show

EJU40335

## Equipment

EJU44600

### Seat

The seat is removable.

Remove the seat to access the fire extinguisher holder, seat storage compartment, and engine compartment.

#### To remove the seat:

- (1) Pull the seat latch up, and then lift up the rear of the seat.

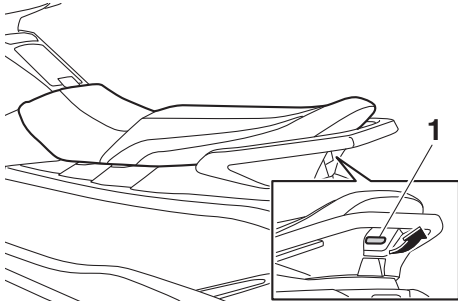

1 Seat latch

- (2) Pull the seat rearward and remove it.

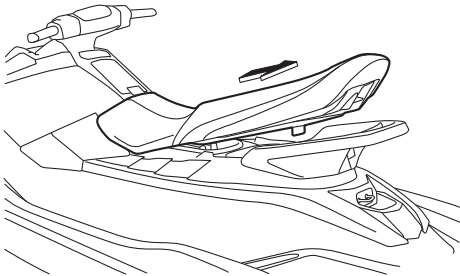

#### To install the seat:

- (1) Insert the projection on the front of the seat into the stay on the deck.

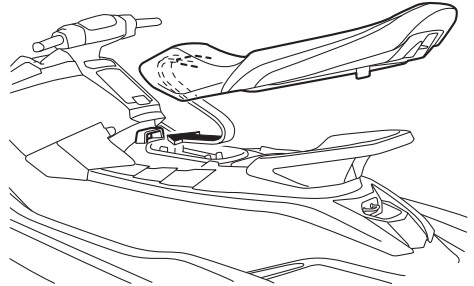

- (2) Push the rear of the seat down to securely lock it in place.

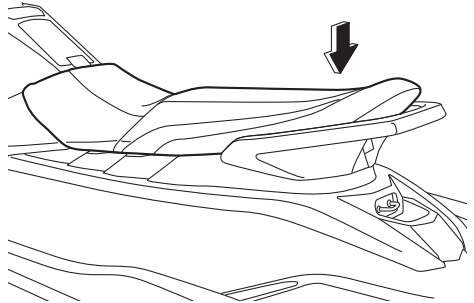

EJU31364

### Handgrip

The handgrip is used when boarding the watercraft from the water and when the spotter is facing rearward. **WARNING! Do not use the handgrip to lift the watercraft. The handgrip is not designed to support the watercraft's weight. If the handgrip**

# Equipment operation

breaks, the watercraft could fall, which could result in severe injury. [EWJ00022]

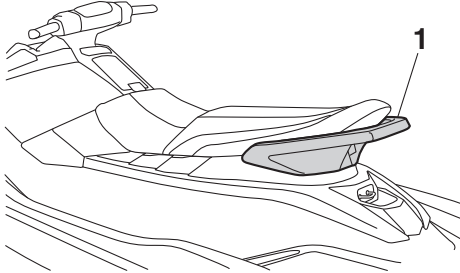

1 Handgrip

EJU37382

## Reboarding grip

The reboarding grip is used when boarding the watercraft from the water.

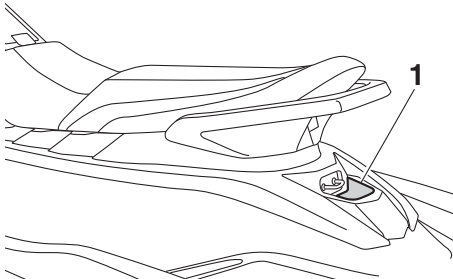

1 Reboarding grip

EJU34865

## Reboarding step (EX Sport / EX Deluxe)

The reboarding step is used to assist in reboarding the watercraft from the water.

When boarding the watercraft, push the reboarding step down until it stops. The step returns automatically to its original position when released. **WARNING! Do not use the reboarding step to lift the watercraft. The reboarding step is not designed to support the watercraft's weight. If the reboarding**

step breaks, the watercraft could fall, which could result in severe injury. [EWJ01212]

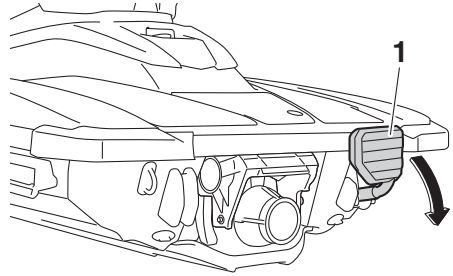

1 Reboarding step

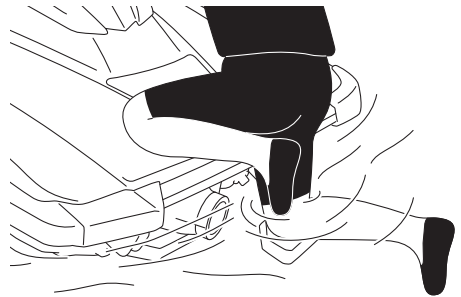

ECJ00743

## NOTICE

**Use the reboarding step only to board the watercraft in the water. Do not use the reboarding step for any other purpose. The watercraft can be damaged.**

# Equipment operation

EJU34873

## Bow eye

The bow eye is used to attach a rope to the watercraft when transporting, mooring, or towing it in an emergency. (See page 93 for information on towing the watercraft.)

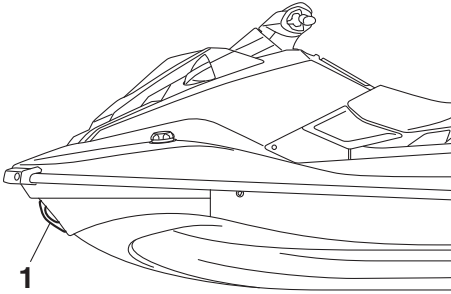

1  
1 Bow eye

EJU34882

## Stern eyes

The stern eyes are used to attach a rope to the watercraft when transporting or mooring it.

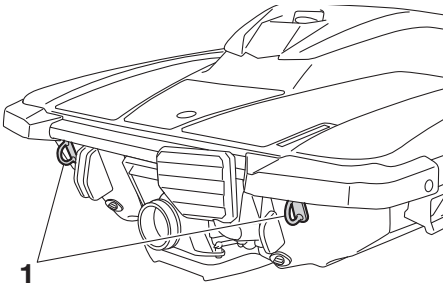

1  
1 Stern eye

EJU40423

## Cleat

The cleat is used to attach a ski rope to the watercraft when pulling a wakeboarder or water-skier. **WARNING! Do not use the cleat to lift the watercraft. The cleat is not designed to support the watercraft's weight. If the cleat breaks, the watercraft**

**could fall, which could result in severe injury.** [EWJ01511]

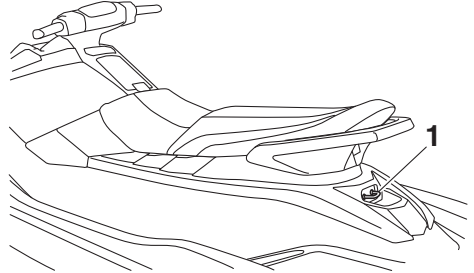

1 Cleat

EJU31685

## Storage compartments

This watercraft is equipped with the following storage compartments.

The storage compartments are not designed to be waterproof. If you carry objects that must be kept dry, put them in a waterproof bag.

Make sure that the storage compartments are closed securely before operating the watercraft.

EJU44660

## Bow storage compartment

The bow storage compartment is located under the hood.

# Equipment operation

## To open the bow storage compartment:

Unhook the hood latches, and then lift up the rear of the hood.

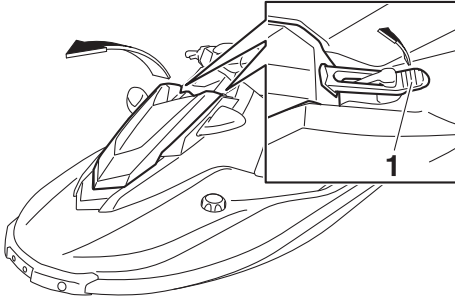

1 Hood latch

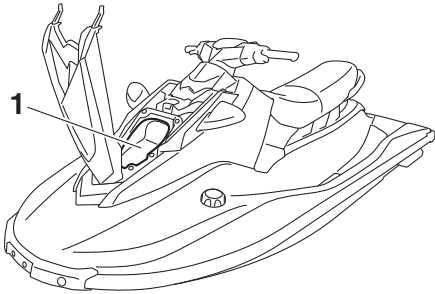

1 Bow storage compartment

### Bow storage compartment:

Capacity:

7.0 L (1.8 US gal, 1.5 Imp.gal)

Load limit:

2.0 kg (4 lb)

## To close the bow storage compartment:

Return the hood to its original position, and then hook the hood latches to secure it in place.

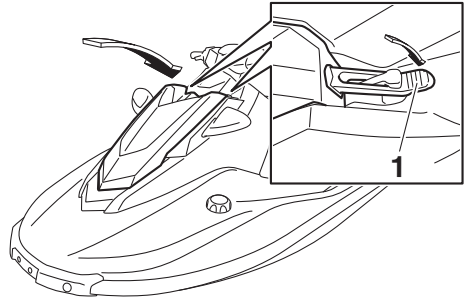

1 Hood latch

EJU43781

### **Glove compartment**

The glove compartment is located in front of the seat.



# Equipment operation

## To open the glove compartment:

Pull the glove compartment latch up, and then lift up the lid.

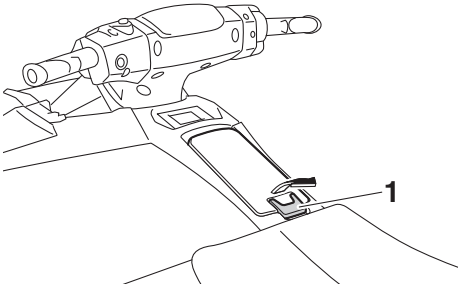

1 Glove compartment latch

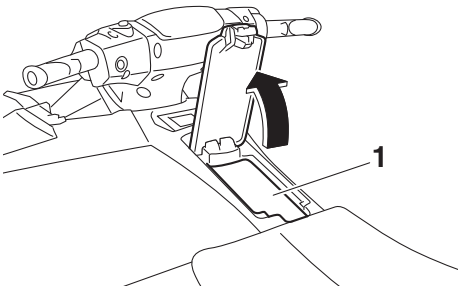

1 Glove compartment

### Glove compartment:

#### Capacity:

14.0 L (3.7 US gal, 3.1 Imp.gal)

#### Load limit:

3.0 kg (7 lb)

## To close the glove compartment:

Push the lid down to securely lock it in place.

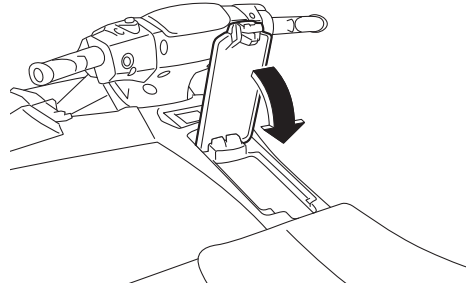

EJU44491

## **Seat storage compartment**

The seat storage compartment is located under the seat. (See page 38 for seat removal and installation procedures.)

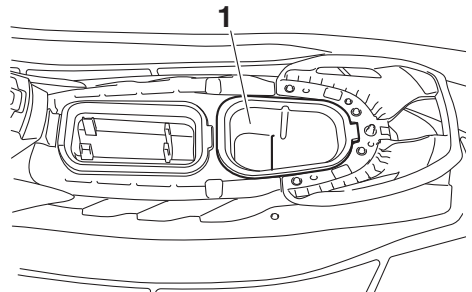

1 Seat storage compartment

### Seat storage compartment:

#### Capacity:

8.0 L (2.1 US gal, 1.8 Imp.gal)

#### Load limit:

3.0 kg (7 lb)

# Equipment operation

---

The storage compartment is removable.

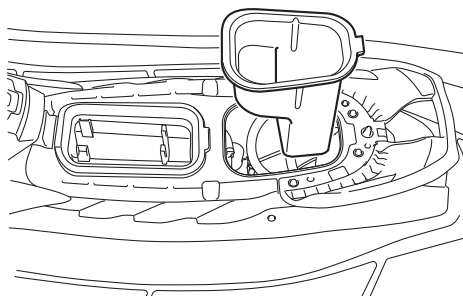

EJU44501

## Fire extinguisher holder

The fire extinguisher holder is located under the seat. (See page 38 for seat removal and installation procedures.)

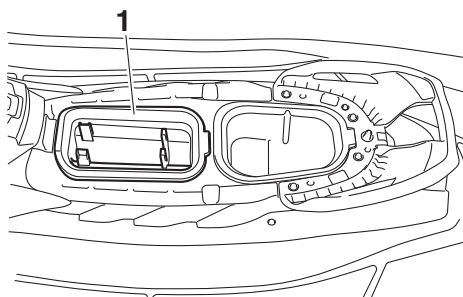

1 Fire extinguisher holder

The fire extinguisher holder is removable.

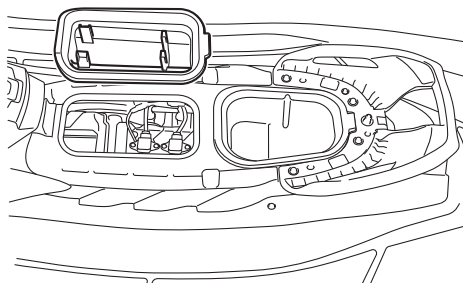

# Operation and handling requirements

EJU31823

## Fuel requirements

EJU44880

### Fuel

EWJ00283



- Gasoline and gasoline vapors are extremely flammable. To avoid fires and explosions and to reduce the risk of injury when refueling, follow these instructions.
- Gasoline is poisonous and can cause injury or death. Handle gasoline with care. Never siphon gasoline by mouth. If you should swallow some gasoline, inhale a lot of gasoline vapor, or get some gasoline in your eyes, see your doctor immediately. If gasoline spills on your skin, wash with soap and water. If gasoline spills on your clothing, change your clothes.

ECJ00322

### NOTICE

- Do not use leaded gasoline. Leaded gasoline can seriously damage the engine.
- Avoid getting water and contaminants in the fuel tank. Contaminated fuel can cause poor performance and engine damage. Use only fresh gasoline that has been stored in clean containers.

Recommended fuel:

Regular unleaded gasoline with a minimum octane rating of

86

(Pump octane number) = (R + M)/2  
90 (Research octane number)



### TIP:

- This mark identifies the recommended fuel for this watercraft as specified by European regulation (EN228).
- Check that gasoline nozzle has the same identifier when fueling.

### Gasohol

There are two types of gasohol: gasohol containing ethanol and that containing methanol. Gasohol containing ethanol can be used if ethanol content does not exceed 10% and the fuel meets the minimum octane ratings. E-85 is a fuel blend containing 85% ethanol and therefore must not be used in this watercraft. All ethanol blends containing more than 10% ethanol can cause fuel system damage or engine performance problems.

Yamaha does not recommend gasohol containing methanol because it can cause fuel system damage and engine performance problems.

To fill the fuel tank:

- (1) Before refueling, stop the engine. Do not stand or sit on the watercraft. Never refuel while smoking, or while in the vicinity

# Operation and handling requirements

of sparks, open flames, or other sources of ignition.

- (2) Place the watercraft in a well-ventilated area and in a horizontal position.
- (3) Remove the seat and fire extinguisher holder, and then check the fuel level. (See page 38 for seat removal and installation procedures and page 43 for information on the fire extinguisher holder.)

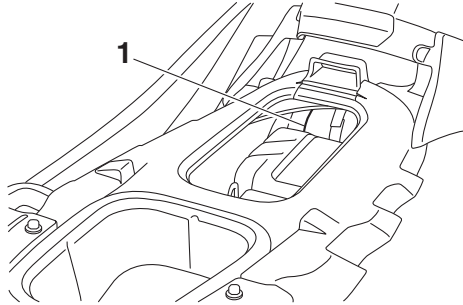

1 Fuel tank

- (4) Loosen the fuel filler cap and remove it.

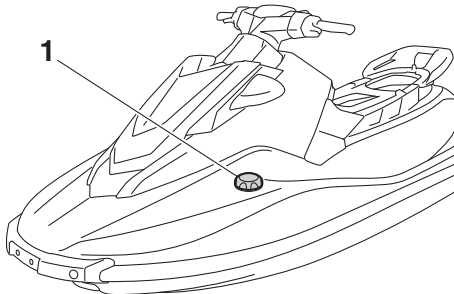

1 Fuel filler cap

- (5) Slowly add fuel to the fuel tank.

Fuel tank capacity:  
50 L (13.2 US gal, 11.0 Imp.gal)

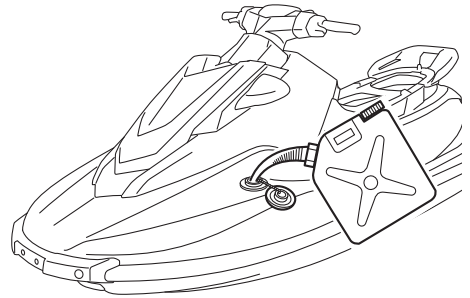

- (6) Stop filling when the fuel level reaches approximately 50 mm (2 in) from the top of the fuel tank. Do not overfill the fuel tank. Because fuel expands when it heats up, heat from the engine or the sun can cause fuel to spill out of the fuel tank.

# Operation and handling requirements

Do not leave the watercraft with a full tank in direct sunlight.

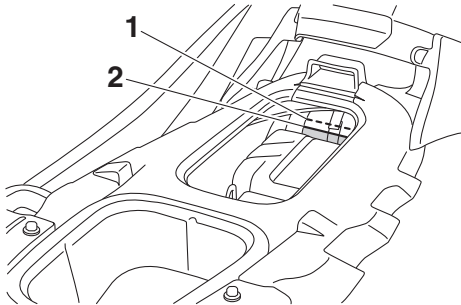

- 1 Top of the fuel tank
- 2 Approximately 50 mm (2 in) from top of the fuel tank

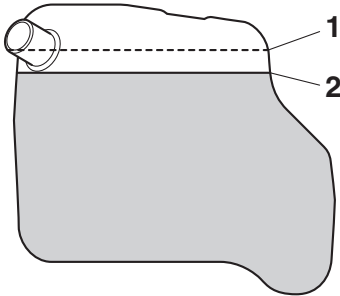

- 1 Top of the fuel tank
  - 2 Approximately 50 mm (2 in) from top of the fuel tank
- (7) Wipe up any spilled fuel immediately with a dry cloth.
  - (8) Securely install the fuel filler cap by tightening it until it clicks.
  - (9) Securely install the fire extinguisher holder and seat in their original positions.

EJU40291

## Engine oil requirements

EJU44531

### Engine oil

ECJ00282

#### **NOTICE**

**Use only 4-stroke engine oil. Usage of 2-stroke engine oil could result in severe engine damage.**

Recommended engine oil:  
YAMALUBE 4W or 4-stroke motor oil  
Recommended engine oil type:  
SAE 10W-30, 10W-40, 20W-40,  
20W-50  
Recommended engine oil grade:  
API SG, SH, SJ, SL

#### Why Yamalube

YAMALUBE oil is a Genuine YAMAHA Part born of the engineers' passion and belief that engine oil is an important liquid engine component. We form teams of specialists in the fields of mechanical engineering, chemistry, electronics and track testing, and have them develop the engine together with the oil it will use. Yamalube oils take full advantage of the base oil's qualities and blend in the ideal balance of additives to make sure the final oil clears our performance standards. Thus, Yamalube mineral, semisynthetic and synthetic oils have their own distinct characters and value. Yamaha's experience gained over many years of research and development into oil since the 1960's helps make Yamalube the best choice for your Yamaha engine.



# Operation and handling requirements

## Checking the engine oil level

EWJ00341



### WARNING

**Engine oil is extremely hot immediately after the engine is turned off. Coming in contact with or getting any engine oil on your clothes could result in burns.**

ECJ00392

### NOTICE

- Do not run the engine with too much or not enough oil in the oil tank, otherwise the engine could be damaged.
- Make sure that debris and water do not enter the oil tank filler hole. Debris and water in the engine oil can cause serious engine damage.

### TIP:

- When checking the engine oil level on land, the engine must be running while water is being supplied to the cooling water passages. (See “Flushing the cooling water passages” on page 76 for information on supplying water.)
- When checking the engine oil level on water, moor the watercraft so that it will not drift away.

### To check the engine oil level:

- (1) With the engine stopped, place the watercraft in a precisely level position on land or launch the watercraft.
- (2) Look in all directions, and then start the engine. (See page 63 for information on starting the engine.)
- (3) Run the engine at idling speed for 6 minutes or more. Run the engine an additional 5 minutes if the ambient temperature is 20 °C (68 °F) or less.
- (4) Stop the engine.
- (5) Remove the seat and seat storage compartment. (See page 38 for seat removal

and installation procedures and page 42 for information on the seat storage compartment.)

- (6) Loosen the oil tank filler cap and remove it, and then wipe the attached dipstick clean.

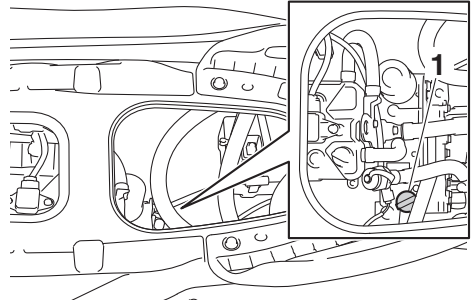

1 Oil tank filler cap/Dipstick

- (7) Screw the oil tank filler cap into the filler hole until it stops. Remove the oil tank filler cap again and make sure that the engine oil level is between the minimum and maximum level marks.

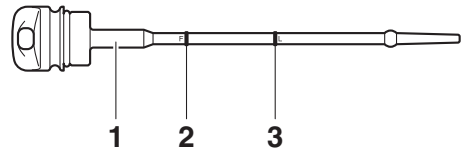

- 1 Dipstick
- 2 Maximum level mark
- 3 Minimum level mark

- (8) If the engine oil level is significantly above the maximum level mark, consult a Yamaha dealer. If the engine oil level is below the minimum level mark, slowly add engine oil.

# Operation and handling requirements

- (9) Repeat steps 6–8 until the engine oil is at the proper level.
- (10) Securely install the oil tank filler cap and turn it until it stops.
- (11) Securely install the seat storage compartment and seat in their original positions.

EJU40022

## Draining the bilge water

ECJ01302

### **NOTICE**

**Do not run the engine at full throttle when bilge water remains in the engine compartment. The bilge water can splash into the engine, which can result in severe damage.**

EJU44260

## Draining the bilge water on land

To drain the bilge water on land:

- (1) Loosen the stern drain plugs and remove them.

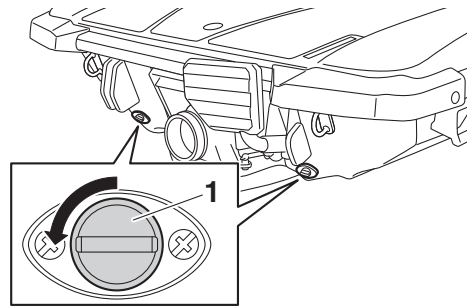

1 Stern drain plug

- (2) Raise the bow of the watercraft, such as by placing the watercraft on a slope, to drain the bilge water from the engine compartment.
- (3) After the bilge water has drained from the stern drain plug holes, wipe up any remaining moisture in the engine compartment with a dry cloth.
- (4) Check that the stern drain plugs and O-rings on the plugs are not damaged and that there is no foreign material on the threads or O-rings on the plugs.

**NOTICE:** Before installing the stern drain plugs, clean the drain plug threads and the O-rings on the plugs to remove any foreign materials, such as dirt or sand. Otherwise, the stern

# Operation and handling requirements

drain plugs could be damaged, allowing water to enter the engine compartment. Check the O-rings on the stern drain plugs and make sure that the plugs are tightened securely before launching the watercraft. Otherwise, water may flood the engine compartment and cause the watercraft to submerge. [ECJ00363]

engine compartment can splash into the engine, which can result in severe damage. [ECJ00554]

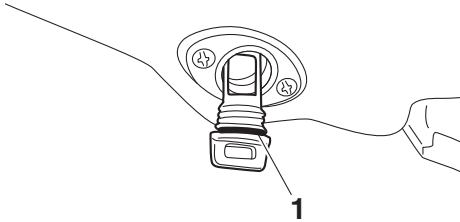
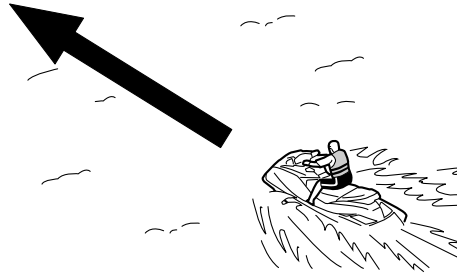

1 O-ring

- (5) Securely install the stern drain plugs by tightening them until they stop.

EJU40535

## Draining the bilge water on water

A small quantity of bilge water will remain in the engine compartment even after the bilge water is drained on water. To completely drain the bilge water, remove the watercraft from the water and drain the bilge water on land.

## Jet vacuum bilge draining system

While the watercraft is operating, bilge water in the engine compartment is drawn in by the vacuum that is generated in the jet pump and discharged from the watercraft through the jet thrust nozzle.

### To drain the bilge water on water:

Operate the watercraft as straight as possible and above planing speed for at least 2 minutes. **NOTICE: Do not run the engine at full throttle for at least 1 minute after the engine has been restarted. Bilge water in the**



# Operation and handling requirements

EJU33465

## Transporting on a trailer

When transporting the watercraft on a trailer, secure the tie downs to the trailer through the bow eye and stern eyes. **NOTICE: Do not attach ropes or tie downs to any part of the watercraft other than the bow eye and stern eyes to secure the watercraft to the trailer. Otherwise, the watercraft may be damaged. Wrap the ropes or tie downs with towels or rags where they touch the body of the watercraft to avoid scratches or damage. EX Sport: Do not transport the watercraft with the shift lever in the reverse position. Otherwise, the reverse gate may hit an obstacle, which could cause damage.** [ECJ00645]

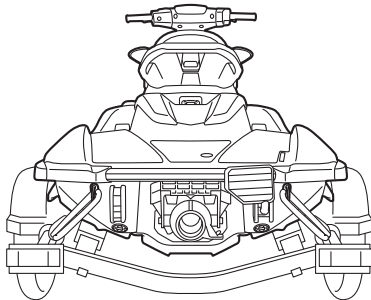
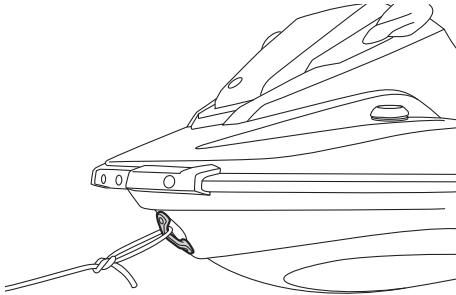

# First-time operation

---

EJU32786

## Engine break-in

ECJ00432

### **NOTICE**

---

**Failure to perform the engine break-in could result in reduced engine life or even severe engine damage.**

---

The engine break-in is essential to allow the various components of the engine to wear and polish themselves to the correct operating clearances. This ensures proper performance and promotes longer component life.

To perform the engine break-in:

- (1) Check the engine oil level. (See page 46 for information on checking the engine oil level.)
- (2) Launch the watercraft and start the engine. (See page 63 for information on starting the engine.)
- (3) For the first 5 minutes, operate with the engine at idling speed.
- (4) For the next 30 minutes, operate with the engine speed below 5000 r/min.
- (5) For the next 1 hour, operate with the engine speed below 6500 r/min.

After the engine break-in is complete, the watercraft can be operated normally.

# Pre-operation checks

EJU31982

EWJ00412



Failure to inspect or maintain the watercraft properly increases the possibility of an accident or damage to the watercraft. Do not operate the watercraft if you find any problem. If a problem cannot be corrected by the procedures provided in this manual, have the watercraft inspected by a Yamaha dealer.

EJU41235

## Pre-operation checklist

Before using this watercraft, be sure to perform the checks in the following checklist.

ITEM	ROUTINE	PAGE
<b>PRE-LAUNCH CHECKS</b>		
<b>Engine compartment</b>	Ventilate the engine compartment. Check inside the engine compartment for damage.	54
<b>Fuel system</b>	Check the fuel system for leakage. Check the fuel level in the fuel tank.	54
<b>Water separator</b>	Check the water separator for water.	55
<b>Engine unit</b>	Check the exterior of the engine unit for damage.	55
<b>Engine oil level</b>	Check the engine oil level.	55
<b>Bilge water</b>	Check the engine compartment for bilge water.	55
<b>Battery</b>	Check the battery connections and electrolyte level.	55
<b>Steering system</b>	Check the steering system for proper operation.	56
<b>Reverse system (EX Sport)</b>	Check the reverse system for proper operation.	57
<b>RiDE lever (EX Deluxe)</b>	Check the RiDE lever for proper operation.	57
<b>Throttle lever</b>	Check the throttle lever for proper operation.	58
<b>Engine shut-off cord (lanyard)</b>	Check the engine shut-off cord (lanyard) for damage.	58
<b>Switches</b>	Check the start switch, engine stop switch, and engine shut-off switch for proper operation.	58
<b>Storage compartments</b>	Check the storage compartments for damage and water.	59
<b>Fire extinguisher holder</b>	Check the fire extinguisher holder for damage.	59
<b>Fire extinguisher</b>	Check the condition of the fire extinguisher.	59
<b>Safety equipment</b>	Check that safety equipment meeting the applicable regulations is on board.	59
<b>Hull and deck</b>	Check the hull and deck for damage.	59
<b>Jet intake</b>	Check the jet intake for damage and clogging.	59
<b>Jet thrust nozzle and reverse gate (EX Sport / EX Deluxe)</b>	Check the jet thrust nozzle and reverse gate for damage.	59
<b>Stern drain plugs</b>	Check the stern drain plugs for damage and foreign material and check that they are securely installed.	59

# Pre-operation checks

---

ITEM	ROUTINE	PAGE
Hood	Check that the hood is securely closed.	60
Seat	Check that the seat is securely installed.	38
<b>POST-LAUNCH CHECKS</b>		
Cooling water pilot outlet	Check that water is discharged from the cooling water pilot outlet while the engine is running.	60
Multifunction information center	Check the multifunction information center for proper operation.	60
Shift system (EX Deluxe)	Check the shift system for proper operation.	61
Engine idling speed	Check the engine idling speed.	61

**TIP:**

To ensure safety and reliability, pre-operation checks should be made each time the watercraft is used.

# Pre-operation checks

EJU32282

## Pre-operation check points

EJU44551

### Pre-launch checks

Perform the pre-launch checks in the pre-operation checklist while the watercraft is on land.

To perform the pre-launch checks:

- (1) Remove the seat, seat storage compartment, and fire extinguisher holder. (See page 38 for seat removal and installation procedures, page 42 for information on the seat storage compartment, and page 43 for information on the fire extinguisher holder.)
- (2) Perform the checks and make sure that there are no malfunctioning items or other problems.
- (3) After completing these checks, securely install the seat storage compartment, fire extinguisher holder, and seat in their original positions.

EJU32334

### Engine compartment check

EWJ00462



**Failure to ventilate the engine compartment could result in a fire or explosion. Do not start the engine if there is a fuel leak.**

Ventilate the engine compartment. Leave the engine compartment open for a few minutes to allow any fuel vapors to escape.

Make sure that there is no damage inside the engine compartment.

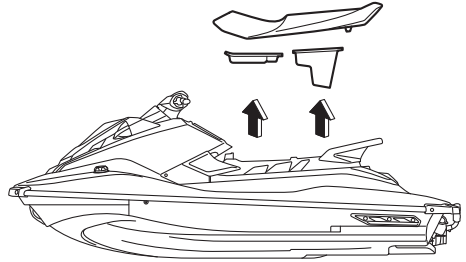

EJU34215

### Fuel system checks

EWJ00382



**Leaking fuel can result in fire or explosion.**

- Check for fuel leakage regularly.
- If any fuel leakage is found, the fuel system must be repaired by a qualified mechanic. Improper repairs can make the watercraft unsafe to operate.

Make sure that there is no damage, leakage, or other problem in the fuel system.

#### Check:

- Fuel filler cap and seal for damage
- Fuel tank for damage and leakage
- Fuel hoses and joints for damage and leakage
- Fuel tank breather hose for damage and leakage

EJU36875

### Fuel level check

Check the fuel level in the fuel tank.

Add fuel if necessary. (See page 44 for information on filling the fuel tank.)

# Pre-operation checks

EJU32424

## Water separator check

Make sure that no water has collected in the water separator. If water has collected in the water separator, drain it. (See page 27 for information on draining the water separator.)

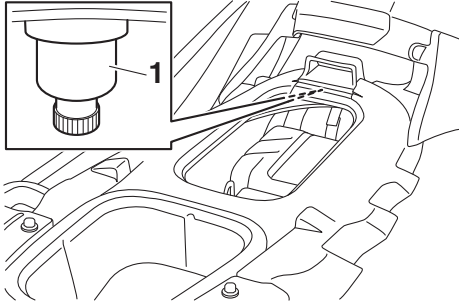

1 Water separator

EJU40182

## Engine unit check

Check the exterior of the engine unit for damage or other problem.

EJU41561

## Engine oil level check

Make sure that the engine oil level is between the minimum and maximum level marks on the dipstick attached to the oil tank filler cap. (See page 46 for information on checking the engine oil level.)

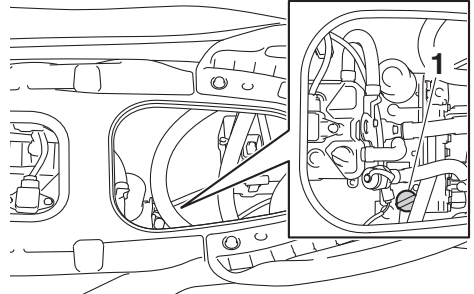

1 Oil tank filler cap/Dipstick

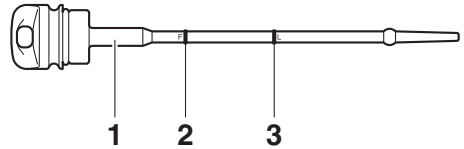

- 1 Dipstick
- 2 Maximum level mark
- 3 Minimum level mark

EJU32456

## Bilge water check

Make sure that no bilge water has collected in the engine compartment. If bilge water has collected in the engine compartment, drain it. (See page 48 for information on draining the bilge water.)

EJU32485

## Battery checks

Make sure that the battery terminals and breather hose are not damaged and that the battery leads and breather hose are connect-

# Pre-operation checks

ed properly. **WARNING! Fire or explosion could result if the breather hose is damaged, obstructed, or not connected properly.** [EWJ00452]

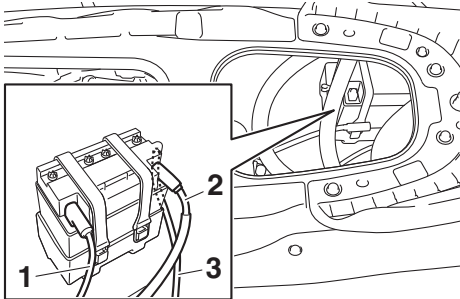

- 1 Negative (-) battery terminal: Black lead
- 2 Positive (+) battery terminal: Red lead
- 3 Breather hose

Make sure that the electrolyte level is between the minimum and maximum level marks. **WARNING! Never operate the watercraft if the battery does not have sufficient power to start the engine or if it shows any other signs of decreased power. Loss of battery power may leave you stranded.** [EWJ01241]

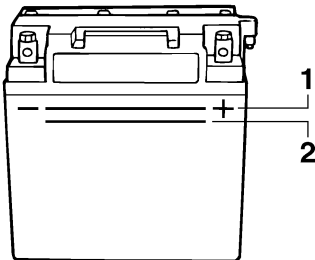

- 1 Maximum level mark
- 2 Minimum level mark

Make sure that the battery is securely held in place.

EJU32614

## Steering system checks

Turn the handlebars to the right and left several times to make sure that operation is smooth and unrestricted throughout the whole range, and that the free play is not excessive.

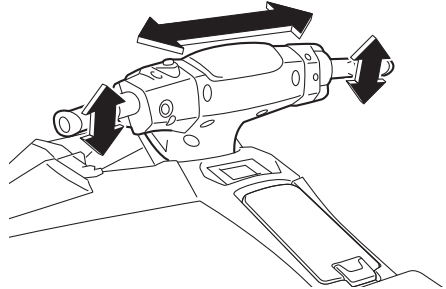

Turn the handlebars as far as possible to the right and left to make sure that the jet thrust nozzle moves as the handlebars are turned, and that there is no difference between the

# Pre-operation checks

right and left fully turned positions of the jet thrust nozzle.

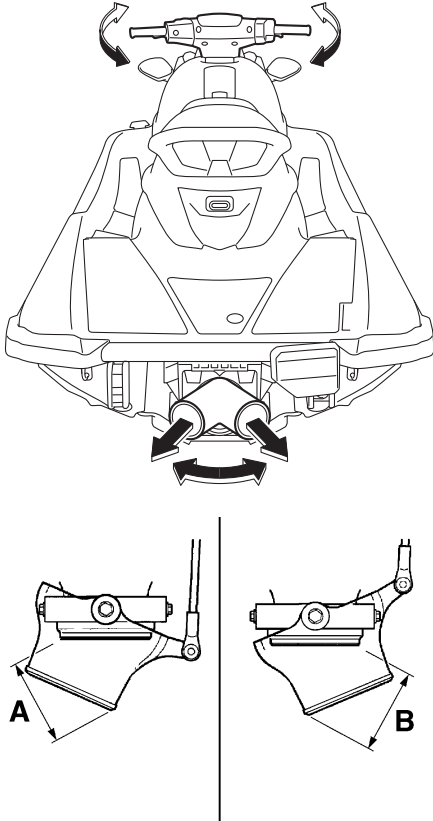

Difference between fully turned positions of jet thrust nozzle (distances A and B):  
Maximum 5 mm (0.20 in)

EJU32636

## Reverse system checks (EX Sport)

EWJ00032

**WARNING**

Do not touch the reverse gate while the shift lever is being operated, otherwise you could be pinched.

Operate the shift lever several times to make sure that operation is smooth throughout the whole range. Also, make sure that the reverse gate moves up and down according to the operation of the shift lever and that the gate makes contact with the stoppers. (See page 29 for reverse system operation.)

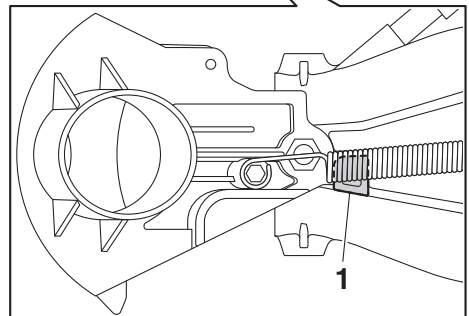
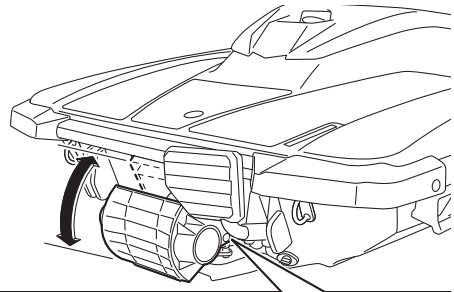
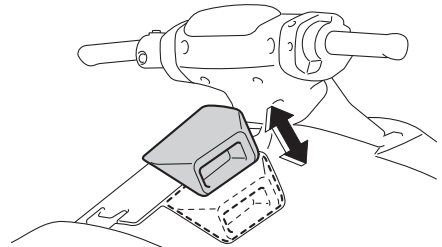

1 Stopper

EJU43213

## RiDE lever checks (EX Deluxe)

Operate the RiDE lever several times to make sure that operation is smooth throughout the



# Pre-operation checks

whole range. Also, make sure that the RiDE lever returns automatically to its fully closed position when released.

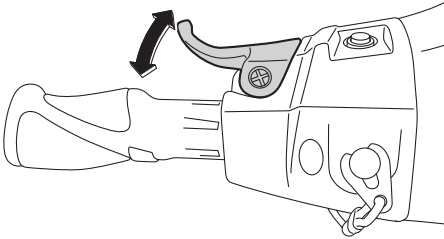

EJU42181

## Throttle lever checks

Operate the throttle lever several times to make sure that operation is smooth throughout the whole range. Also, make sure that the throttle lever returns automatically to its fully closed (idle) position when released.

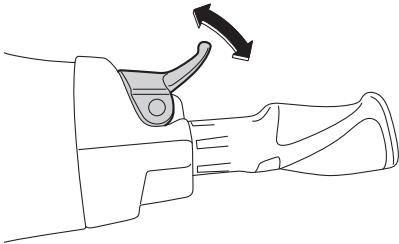

EJU32664

## Engine shut-off cord (lanyard) check

Make sure that the engine shut-off cord (lanyard) is not damaged. If the cord is damaged, replace it. **WARNING! Never try to repair the engine shut-off cord (lanyard) or tie it together. The engine shut-off cord (lanyard) may not pull free when the operator**

**falls off, allowing the watercraft to continue to run and cause an accident.** [EJWJ01221]

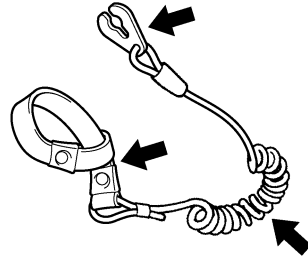

EJU40692

## Switch checks

ECJ01311

### **NOTICE**

**Do not run the engine over 4000 r/min on land. Also, do not run the engine for more than 15 seconds without supplying water, otherwise the engine could overheat.**

Check the start switch, the engine stop switch, and the engine shut-off switch for proper operation. (See pages 25 to 25 for information on operating each switch.)

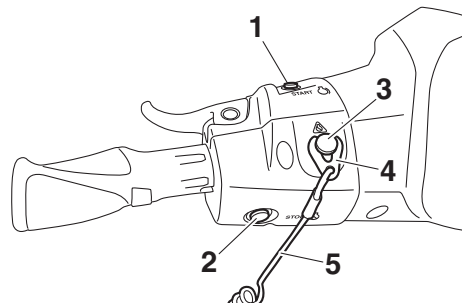

- 1 Start switch
- 2 Engine stop switch
- 3 Engine shut-off switch
- 4 Clip
- 5 Engine shut-off cord (lanyard)

To check the operation of the switches:

- (1) Push the start switch to make sure that the engine starts.

# Pre-operation checks

- (2) As soon as the engine starts running, push the engine stop switch to make sure that the engine stops immediately.
- (3) Restart the engine, and then pull the engine shut-off cord (lanyard) to remove the clip from the engine shut-off switch to make sure that the engine stops immediately.

EJU40102

## Storage compartment checks

Make sure that the storage compartments are not damaged and that water has not collected in the compartments. (See page 40 for information on the storage compartments.)

EJU44670

## Fire extinguisher holder checks

Make sure that the fire extinguisher holder is installed in the correct direction and is not damaged. (See page 43 for information on the fire extinguisher holder.)

EJU44630

## Fire extinguisher check

Check that there is a full fire extinguisher on board.

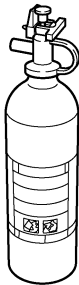

To check the fire extinguisher, see the instructions supplied by the fire extinguisher manufacturer. Always keep the fire extinguisher stored in the holder.

Always carry a fire extinguisher on board. A fire extinguisher is not standard equipment with this watercraft. If you do not have one, contact a Yamaha dealer or a fire extinguish-

er dealer to obtain one meeting the proper specifications.

EJU40122

## Safety equipment check

Check that safety equipment meeting the applicable regulations is on board.

EJU32353

## Hull and deck check

Check the hull and deck for damage or other problem.

EJU32657

## Jet intake checks

Make sure that the jet intake is not damaged or clogged with weeds or debris. If the jet intake is clogged, clean it. (See page 91 for information on the jet intake.)

EJU43221

## Jet thrust nozzle and reverse gate check (EX Sport / EX Deluxe)

Check the jet thrust nozzle and reverse gate for damage or other problem.

EJU44250

## Stern drain plug checks

Loosen the stern drain plugs and remove them, and then make sure that the plugs and O-rings on the plugs are not damaged and that there is no foreign material on the threads or O-rings on the plugs. **NOTICE: Before installing the stern drain plugs, clean the drain plug threads and the O-rings on the plugs to remove any foreign materials, such as dirt or sand. Otherwise, the stern drain plugs could be damaged, allowing water to enter the engine compartment. Check the O-rings on the stern drain plugs and make sure that the plugs are tightened securely before launching the watercraft. Otherwise, water may**

# Pre-operation checks

flood the engine compartment and cause the watercraft to submerge. [ECJ00363]

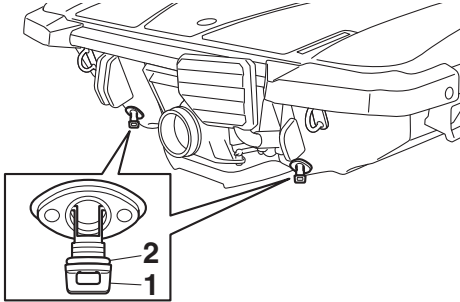

- 1 Stern drain plug
- 2 O-ring

Securely install the stern drain plugs by tightening them until they stop.

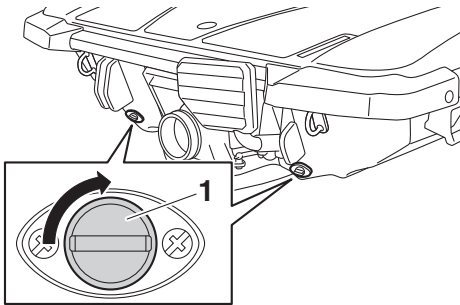

- 1 Stern drain plug

EJU44640

## Hood check

Close the hood, hook the hood latches, and check that the hood is securely closed.

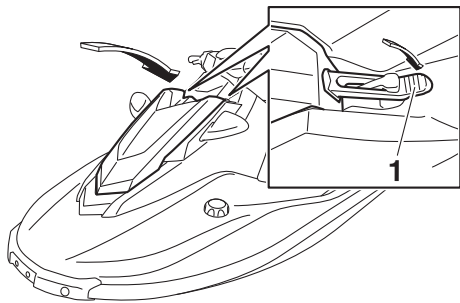

- 1 Hood latch

EJU40146

## Post-launch checks

Perform the post-launch checks in the pre-operation checklist while the watercraft is in the water and the engine is running.

To perform the post-launch checks:

- (1) Launch the watercraft. (See page 63 for information on launching the watercraft.)
- (2) Perform the checks and make sure that there are no malfunctioning items or other problems.

EJU40553

## Cooling water pilot outlet check

Make sure that water is discharged from the cooling water pilot outlet while the engine is running. (See page 27 for information on the cooling water pilot outlet.)

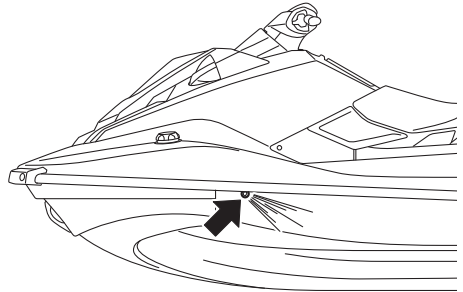

EJU32715

## Multifunction information center check

Make sure that the multifunction information center operates properly. (See page 33 for information on proper operation of the multifunction information center.)

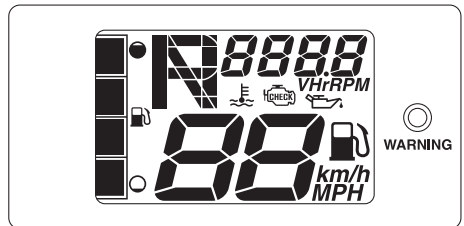

# Pre-operation checks

EJU43392

## Shift system check (EX Deluxe)

Operate the throttle lever and RiDE lever, and check that the watercraft moves or does not move according to the displayed shift indicator. (See page 29 for shift system operation procedures.) **WARNING! To avoid collisions, operate at safe speeds and keep a safe distance away from people, objects, and other watercraft.** [EWJ01860]

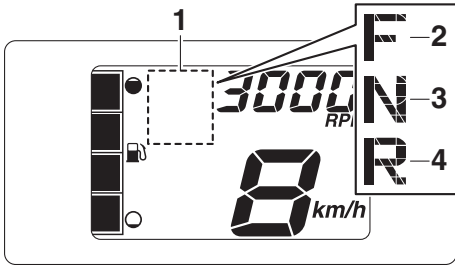

- 1 Shift indicator
- 2 “F” (Forward position)
- 3 “N” (Neutral position)
- 4 “R” (Reverse position)

EJU40172

## Engine idling speed check

Start the engine and warm it up. Use the tachometer in the multifunction information center to make sure that the engine idling speed is not significantly above or below the specified range.

Engine idling speed:  
1500 ±100 r/min

EJU32903

## Operating your watercraft

EWJ00511



**Before operating your watercraft, become familiar with all of the controls. Consult a Yamaha dealer about any control or function that you do not fully understand. Failure to understand how the controls work could cause an accident or prevent you from avoiding an accident.**

EJU32965

## Getting to know your watercraft

Operating your watercraft requires skills acquired through practice over a period of time. Take the time to learn the basic techniques well before attempting more difficult maneuvers.

Operating your new watercraft can be a very enjoyable activity, providing you with hours of pleasure. However, it is essential to familiarize yourself with the operation of the watercraft to achieve the skill level necessary to enjoy riding safely.

Before operating this watercraft, read this owner's/operator's manual, the Riding Practice Guide, the Riding Instruction card, and all labels on the watercraft. Pay particular attention to the safety information beginning on page 10. These materials should give you an understanding of the watercraft and its operation.

Remember: This watercraft is designed to carry the operator and up to 2 passengers. Never exceed the maximum load limit or allow more than 3 persons (or 2 persons if a wakeboarder or water-skier is being pulled) to ride the watercraft at any time.

Maximum load:

220 kg (485 lb)

Load is the total weight of cargo, operator, and passengers.

EJU33006

## Learning to operate your watercraft

Before operating the watercraft, always perform the pre-operation checks listed on page 52. The short time spent checking the watercraft will reward you with added safety and reliability.

Check local laws before operating your watercraft.

Operate defensively at safe speeds and keep a safe distance away from people, objects, and other watercraft. Select a wide area to learn in, where there is good visibility and light boat traffic.

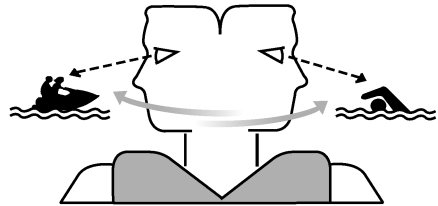

Use the buddy system—operate with someone nearby. Scan constantly for people, objects, and other watercraft. Be alert for conditions that limit your visibility or block your vision of others.

You should grip the handlebars firmly and keep both feet on the floor of the footwell. Do not attempt to ride with passengers until your operating skills are fully developed.

# Operation

EJU40212

## Riding position

### Operator riding position

The operator should grip the handlebars firmly with both hands and sit astride the seat with both feet on the floor of the footwell.



### Passenger riding position

The passenger(s) should hold on firmly, either to the person in front of them or to the hand-grip provided, and sit astride the seat with their feet on the floor of the footwell. Never allow a passenger to ride in front of the operator. (See page 17 for information on the riding position when pulling a wakeboarder or water-skier.)



EJU32803

## Launching the watercraft

When launching the watercraft, make sure that there are no obstacles around you.

If the watercraft is launched from a trailer, someone should make sure that waves do not push the watercraft into the trailer.

EJU43580

## Starting the engine on water

EWJ01531



**Do not apply throttle when anyone is at the rear of the watercraft. Turn the engine off or keep it at idle. Water and debris exiting the jet thrust nozzle can cause severe injury.**

To start the engine:

- (1) Move the watercraft to an area that is free from weeds and debris, and has a water depth of at least 60 cm (2 ft) from the bottom of the watercraft. **NOTICE: Never run the engine in water that is less than 60 cm (2 ft) deep from the bottom of the watercraft, otherwise pebbles or sand could be sucked into the jet intake, causing impeller damage and engine overheating.** [ECJ00473]

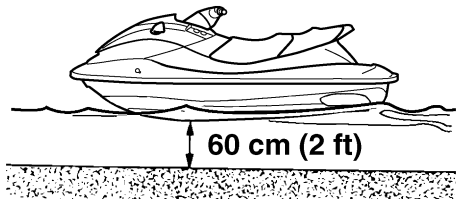

- (2) Attach the engine shut-off cord (lanyard) to your left wrist, and then attach the clip to the engine shut-off switch. (See page 25 for information on operating the engine shut-off switch.) **WARNING! Check that the engine shut-off cord (lanyard) is attached correctly. If the engine shut-off cord (lanyard) is not attached correctly, it may not pull free when the operator falls off, allowing the water-**

craft to continue to run and cause an accident. [EWJ00582]

to avoid. A collision could result in severe injury or death. [EWJ00602]

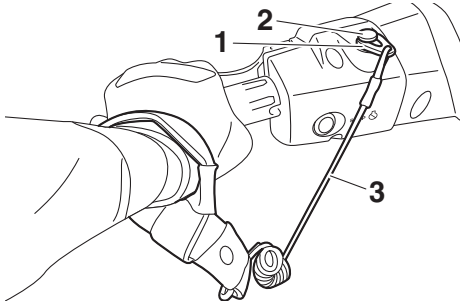

- 1 Clip
- 2 Engine shut-off switch
- 3 Engine shut-off cord (lanyard)

- (3) With the throttle lever released, push the start switch (green button) to start the engine. (See page 25 for information on operating the start switch.)

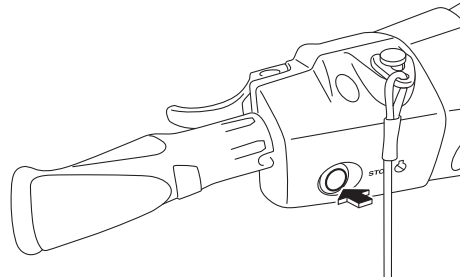

EJU32873

## Leaving the watercraft

If leaving the watercraft, remove the clip from the engine shut-off switch to prevent accidental starting or unauthorized operation by children or others.

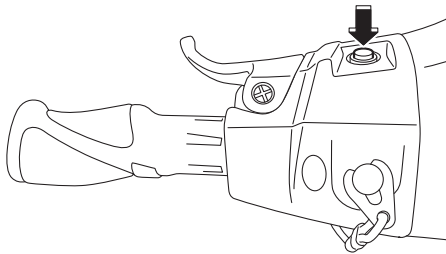

EJU32863

## Stopping the engine

Release the throttle lever, and then push the engine stop switch (red button) to stop the engine. **WARNING! You need throttle to steer. Shutting the engine off can cause you to hit an obstacle you are attempting**

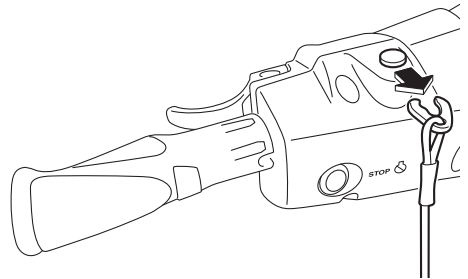

EJU44361

## Operating the watercraft

### EX:

When the engine is running, the watercraft will move forward at trolling speed even if the

# Operation

throttle lever is in the fully closed (idle) position.



## EX Sport:

When the shift lever is in the forward position and the engine is running, the watercraft will move forward. The watercraft will move forward at trolling speed even if the throttle lever is in the fully closed (idle) position. (See page

29 for information on operating the shift lever.)

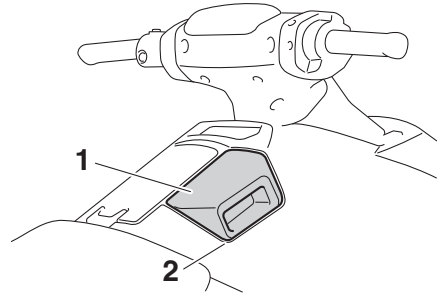

- 1 Shift lever
- 2 Forward position



## EX Deluxe:

When the throttle lever is squeezed, the “F” (forward) shift indicator will be displayed and the watercraft will move forward. While the “F” (forward) shift indicator is displayed, the watercraft will move forward at trolling speed even if the throttle lever is in the fully closed



(idle) position. (See page 29 for shift system operation procedures.)

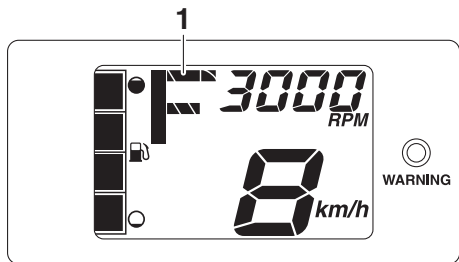

1 "F" (Forward position)



EJU43423

## Turning the watercraft

EWJ01783

### WARNING

- Do not release the throttle lever when trying to steer away from objects—as with other powerboats, you need throttle to steer. A collision could result in severe injury or death.
- When operating at higher speeds, make gradual turns or slow down before turning. Sharp high-speed turns may cause the watercraft to slide sideways or spin, throwing the operator and passenger(s) overboard, which could cause an injury.
- EX Deluxe: Take early action to avoid collisions. The RiDE system is not a

### braking device for avoiding dangerous situations.

Steering control depends on the combination of handlebar position and the amount of throttle.

Water sucked in through the intake grate is pressurized by the impeller in the jet pump. As the pressurized water is expelled from the pump through the jet thrust nozzle, it creates thrust to move and steer the watercraft. The higher the engine speed, the more thrust produced.

The amount of jet thrust, in addition to the position of the handlebars, determines how sharply you turn.

- A. More throttle produces higher thrust, so the watercraft will turn more sharply.

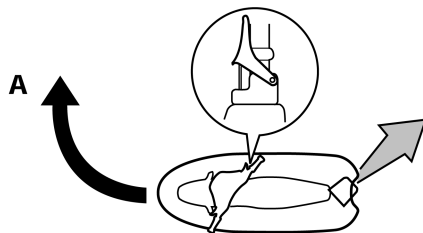

- B. Less throttle produces lower thrust, so the watercraft will turn more gradually.

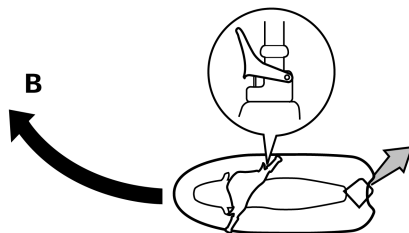

- C. Releasing the throttle lever completely produces only minimum thrust. If you are

# Operation

traveling at speeds above trolling, you will have rapidly decreasing ability to steer without throttle. You may still have some turning ability immediately after releasing the throttle lever, but once the engine slows down, the watercraft will no longer respond to handlebar input until you apply throttle again or you reach trolling speed.

At trolling speed, the watercraft can be turned gradually by handlebar position alone using just the amount of thrust available at idle.

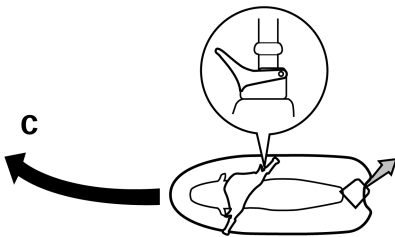

- D. If the engine is stopped while riding, there is no thrust. The watercraft will go straight even though the handlebars are turned.

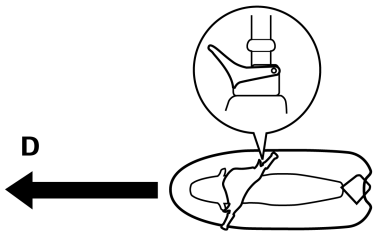

**You need throttle to steer.**

- E. EX Deluxe: If the RiDE lever is squeezed and the handlebars are turned when the

watercraft is cruising at planing speed, the watercraft will turn gradually while slowing down.

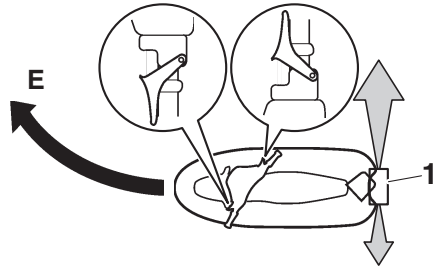

1 Reverse gate

This model is equipped with the Yamaha Engine Management System (YEMS) that includes an off-throttle steering (OTS) system. It will activate at planing speeds should you attempt to steer the watercraft after releasing the throttle lever (see condition C above).

The OTS system assists in turning by continuing to supply some thrust while the watercraft is decelerating, but you can turn more sharply if you apply throttle while turning the handlebars. The OTS system does not function below planing speeds or when the engine is off. Once the engine slows down, the watercraft will no longer turn in response to handlebar input until you apply throttle again or you reach trolling speed.

EJU44371

## Stopping the watercraft

The watercraft is not equipped with a separate braking system. The watercraft slows down by water resistance or, when operating in reverse, by the water jet. The watercraft slows down as soon as the throttle lever is released, but will coast for a distance before fully stopping. If you are not sure you can stop in time before hitting an obstacle, apply throttle and turn in another direction.

From full speed, the watercraft comes to a complete stop due to water resistance in approximately 90 m (300 ft) after the throttle lever is released or the engine is stopped, although this distance will vary depending on many factors, including gross weight, water surface conditions, and wind direction.

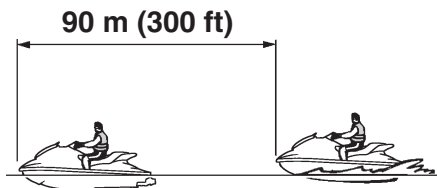

EX Deluxe: If the RiDE lever is squeezed to slow down, the stopping distance is approximately 30% shorter than when the RiDE lever is not used. However, this distance will vary depending on many factors, including gross weight, water surface conditions, and wind direction.

EWJ01971

## **WARNING**

- **Allow adequate stopping distance. Stay far enough away from others so you can always safely coast to a stop.**
- **Take early action to avoid collisions. Remember, watercraft and other boats do not have brakes.**
- **Operate defensively at safe speeds and keep a safe distance away from people, objects, and other watercraft to give you time to stop.**
- **Do not shut the engine off when slowing down in case you need engine power to steer away from a boat or other obstacle that comes into your path.**

- **EX Sport: Do not use the reverse function to slow down or stop the watercraft as it could cause you to lose control, be ejected, or impact the handlebars.**
- **EX Deluxe: To avoid rear-end collisions while operating the watercraft, check behind you before using the RiDE lever to slow down or stop the watercraft.**

EJU44682

## **Operating the watercraft in reverse or neutral (EX Sport / EX Deluxe)**

### **Operating in reverse (EX Sport)**

Pull the shift lever rearward to the reverse position. The watercraft will move in reverse. (See page 29 for information on the reverse system.)

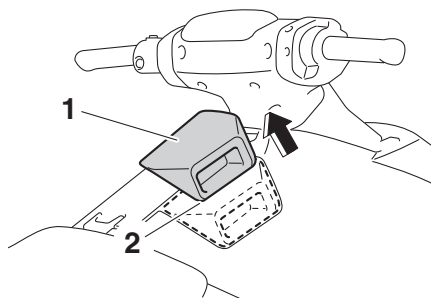

- 1 Shift lever
- 2 Reverse position



Make sure that there are no obstacles or people behind you before shifting into reverse.

# Operation

## TIP:

This model is not equipped with a neutral function.

### Operating in reverse (EX Deluxe)

When the RiDE lever is squeezed, the “R” (reverse) shift indicator will be displayed and the watercraft will move in reverse. (See page 29 for shift system operation procedures.)

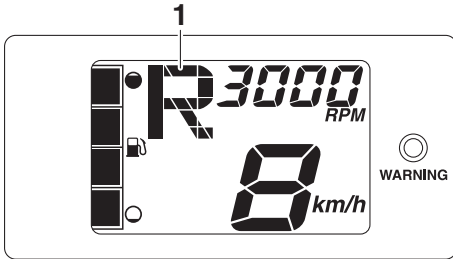

1 “R” (Reverse position)



Make sure that there are no obstacles or people behind you before shifting into reverse.

## TIP:

This model is equipped with a function which limits the engine speed in reverse.

### Operating in neutral (EX Deluxe)

When the RiDE lever is squeezed lightly and released, the “N” (neutral) shift indicator will be displayed and the watercraft will stop in its

current location. (See page 29 for shift system operation procedures.)

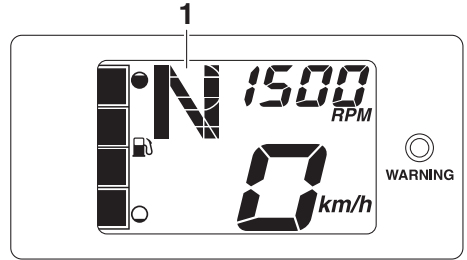

1 “N” (Neutral position)



EJU36087

## Boarding the watercraft

EWJ01112

### **WARNING**

Be sure the operator and any passengers have practiced boarding from the water while still close to shore before riding. A person who has made many unsuccessful attempts to get back on the watercraft may become fatigued and suffer from exposure, increasing the risk of injury and drowning.

Board the watercraft in water free from weeds and debris and at least 60 cm (2 ft) deep from the bottom of the watercraft. **NOTICE:** Never run the engine in water that is less than 60 cm (2 ft) deep from the bottom of the watercraft, otherwise peb-

bles or sand could be sucked into the jet intake, causing impeller damage and engine overheating. [ECJ00473]

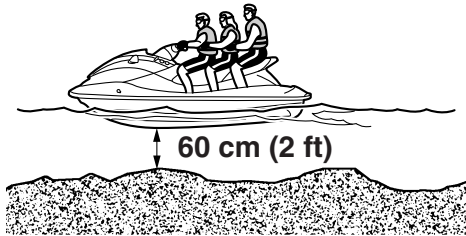

## TIP:

EX Sport / EX Deluxe: This watercraft is equipped with a reboarding step, which can be lowered and used to assist in reboarding. (See page 39 for information on operating the reboarding step.)

EJU36354

## Boarding alone

- (1) From the rear of the watercraft, place both hands on the boarding platform, pull yourself up, and then grasp the handgrip with one hand.

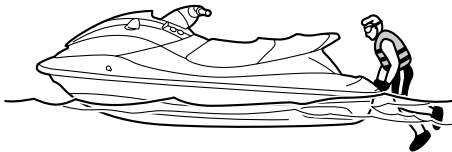

- (2) Pull yourself up to a kneeling position on the boarding platform, and then move to the seat and sit astride.

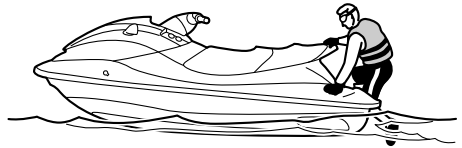

- (3) Attach the engine shut-off cord (lanyard) to your left wrist, and then attach the clip to the engine shut-off switch.
- (4) Grip the handlebars with both hands and place both feet on the floor of the footwell.



- (5) Look in all directions, start the engine, and then start off slowly.

EJU43260

## Boarding with passenger(s)

EWJ01800

### **WARNING**

- Severe internal injuries can occur if water is forced into body cavities as a result of being near the jet thrust nozzle. Do not start the engine until the passengers are seated with their feet on the floor of the footwell and are securely

# Operation

---

**holding on to the person in front of them or to the handgrip provided.**

- **Before boarding the watercraft, make sure that the engine is stopped. If the engine is running, the reverse gate may move down and a person boarding could be pinched.**

The heavier the total weight of the operator and passenger(s), the more difficult it will be to balance the watercraft. Do not operate the watercraft when the total weight exceeds 220 kg (485 lb) including any cargo.

To board with passenger(s):

- (1) Board as noted in the previous section "Boarding alone".

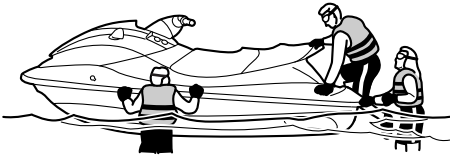

- (2) Grip the handlebars with both hands and place both feet on the floor of the footwell.
- (3) Have the first passenger move to the rear of the watercraft.

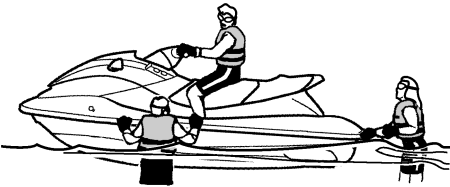

- (4) Have the first passenger board using the same procedure as the operator, place their feet on the floor of the footwell, and securely hold on to the operator.

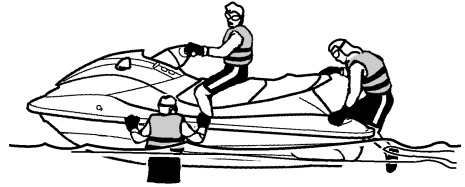

- (5) Have the second passenger follow the same procedure. When the second passenger is boarding, try to balance the watercraft together with the first passenger.



- (6) Make sure that the passenger(s) have their feet on the floor of the footwell and

are securely holding on to the person in front of them or to the handgrip provided.

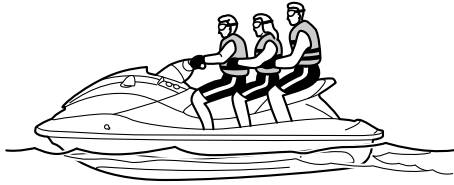

- (7) Attach the engine shut-off cord (lanyard) to your left wrist, and then attach the clip to the engine shut-off switch.
- (8) Look in all directions, start the engine, and then start off slowly.

EJU33084

## Starting off

EWJ00713

### **WARNING**

#### To avoid collisions:

- **Scan constantly for people, objects, and other watercraft. Be alert for conditions that limit your visibility or block your vision of others.**
- **Operate defensively at safe speeds and keep a safe distance away from people, objects, and other watercraft.**
- **Do not follow directly behind watercraft or other boats. Do not go near others to spray or splash them with water, go too close to other boats, or go too fast for the traffic conditions. Avoid sharp turns or other maneuvers that make it hard for others to avoid you or understand where you are going. Avoid areas with submerged objects or shallow water.**
- **Take early action to avoid collisions. Remember, watercraft and other boats do not have brakes. Do not release the throttle lever when trying to steer away**

from objects—as with other powerboats, you need throttle to steer.

ECJ01341

### **NOTICE**

**Never run the engine in water that is less than 60 cm (2 ft) deep from the bottom of the watercraft, otherwise pebbles or sand could be sucked into the jet intake, causing impeller damage and engine overheating.**

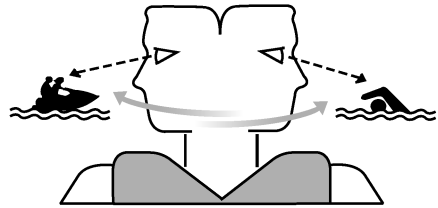

EJU44381

#### Starting off from a trailer

##### EX:

- (1) Launch the watercraft, and then turn it around so that the bow faces the direction you wish to go.
- (2) Attach the engine shut-off cord (lanyard) to your left wrist, and then attach the clip to the engine shut-off switch.
- (3) Look in all directions, start the engine, and then start off slowly.

##### EX Sport:

- (1) Launch the watercraft, and then move the shift lever to the reverse position. (See page 29 for information on the reverse system.)
- (2) Attach the engine shut-off cord (lanyard) to your left wrist, and then attach the clip to the engine shut-off switch.
- (3) Look in all directions, start the engine, and then start off slowly.

# Operation

## EX Deluxe:

- (1) Launch the watercraft.
- (2) Attach the engine shut-off cord (lanyard) to your left wrist, and then attach the clip to the engine shut-off switch.
- (3) Look in all directions, and then start the engine.
- (4) Squeeze the RiDE lever and move the watercraft back slowly. (See page 29 for RiDE lever operation procedures.)

EJU33114

## Boarding and starting off from a dock

- (1) Board the watercraft from the side.
- (2) Attach the engine shut-off cord (lanyard) to your left wrist, and then attach the clip to the engine shut-off switch.
- (3) Push the watercraft away from the dock, grip the handlebars with both hands, and place both feet on the floor of the foot-well.

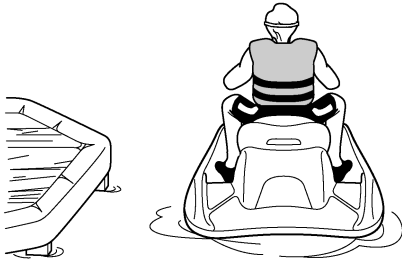

- (4) Look in all directions, start the engine, and then start off slowly.

EJU44210

## Capsized watercraft

EWJ00672



**WARNING**

**Improper uprighting can cause injury.**

- **Be sure to shut the engine off by pulling on the engine shut-off cord (lanyard) to remove the clip from the engine shut-off switch.**

- **Do not put your hands in the intake grate.**

If the watercraft capsizes, turn it over immediately.

## To upright the watercraft:

- (1) Remove the clip from the engine shut-off switch.
- (2) Swim to the rear of the watercraft. Turn the watercraft over by pulling on the ride plate with one hand while pushing down on the gunwale with your other hand or your foot.



- (3) Start the engine and operate the watercraft at planing speed to drain the bilge water from the engine compartment. (See page 48 for information on draining the bilge water. If the engine does not start, see "Towing the watercraft" on page 93 or "Submerged watercraft" on page 93.) **NOTICE: Do not run the engine at full throttle for at least 1 minute**



after the engine has been restarted. **Bilge water in the engine compartment can splash into the engine, which can result in severe damage.**

[ECJ00554]

EJU44390

## **Beaching and docking the watercraft**

### To beach the watercraft (EX / EX Sport):

- (1) Make sure that there are no boats, swimmers, or obstacles near the beach.
- (2) Release the throttle lever to reduce speed about 90 m (300 ft) before you reach the intended beaching area.
- (3) Slowly approach the beach and stop the engine just before reaching land. **WARNING! You need throttle to steer. Shutting the engine off can cause you to hit an obstacle you are attempting to avoid. A collision could result in severe injury or death.** [EJVJ00602] **NOTICE: Never run the engine in water that is less than 60 cm (2 ft) deep from the bottom of the watercraft, otherwise pebbles or sand could be sucked into the jet intake, causing impeller damage and engine overheating.** [ECJ00473]
- (4) Get off the watercraft and pull it up on the beach.

### To beach the watercraft (EX Deluxe):

- (1) Make sure that there are no boats, swimmers, or obstacles near the beach.
- (2) Release the throttle lever to reduce speed about 90 m (300 ft) before you reach the intended beaching area.
- (3) Slowly approach the beach using the throttle lever and RiDE lever to control the watercraft speed. **NOTICE: Never run the engine in water that is less than 60 cm (2 ft) deep from the bottom of the watercraft, otherwise pebbles or sand could be sucked into the jet**

**intake, causing impeller damage and engine overheating.** [ECJ00473]

- (4) After reaching land, stop the engine, and then get off the watercraft and pull it up on the beach.

### To dock the watercraft (EX / EX Sport):

- (1) Make sure that there are no boats, swimmers, or obstacles near the dock.
- (2) Release the throttle lever to reduce speed about 90 m (300 ft) away from the dock.
- (3) Slowly approach the dock and stop the engine just before coming alongside it. **WARNING! You need throttle to steer. Shutting the engine off can cause you to hit an obstacle you are attempting to avoid. A collision could result in severe injury or death.** [EJVJ00602]
- (4) Come alongside the dock and get off the watercraft.

### To dock the watercraft (EX Deluxe):

- (1) Make sure that there are no boats, swimmers, or obstacles near the dock.
- (2) Release the throttle lever to reduce speed about 90 m (300 ft) away from the dock.
- (3) Slowly approach the dock using the throttle lever and RiDE lever to control the watercraft speed.
- (4) After coming alongside the dock, stop the engine, and then get off the watercraft.

EJU37194

## **Operating in weeded areas**

Always avoid using your watercraft in areas where weed growth is thick. If operating in weeded areas is unavoidable, alternately squeeze the throttle lever and relax your grip on the throttle lever to vary the engine speed. Weeds tend to become clogged more when operating at a steady speed and at trolling speed. If weeds may have clogged the intake

# Operation

---

area, clean the jet intake. (See page 91 for information on the jet intake.)

EJU40242

## **After removing the watercraft from the water**

ECJ01311

### **NOTICE**

---

**Do not run the engine over 4000 r/min on land. Also, do not run the engine for more than 15 seconds without supplying water, otherwise the engine could overheat.**

---

After operating and removing the watercraft from the water, promptly discharge the remaining water from the cooling water passages.

To discharge water from the cooling water passages:

- (1) Make sure that the area around the watercraft is clear, and then start the engine.
- (2) Discharge the remaining water out of the cooling water passages by alternately squeezing and releasing the throttle lever quickly for 10 to 15 seconds.
- (3) Stop the engine.

EJU37146

## Post-operation care

EWJ00331

### **WARNING**

Always place the watercraft upright in a horizontal position when storing it, otherwise fuel could leak out into the engine or engine compartment, which could create a fire hazard.

After using the watercraft, always take it out of the water, clean it, and store it. Leaving the watercraft in the water for extended periods will accelerate the rate of normal deterioration of the jet pump and hull. Marine organisms and corrosion are some of the conditions that can shorten the life of many watercraft components.

EJU44560

## Flushing the cooling water passages

ECJ01311

### **NOTICE**

Do not run the engine over 4000 r/min on land. Also, do not run the engine for more than 15 seconds without supplying water, otherwise the engine could overheat.

Flush the cooling water passages to prevent them from clogging with salt, sand, or dirt.

- (1) Place the watercraft in a horizontal position.
- (2) Remove the seat and seat storage compartment. (See page 38 for seat removal and installation procedures and page 42 for information on the seat storage compartment.)

- (3) Connect the garden hose adapter to a garden hose.

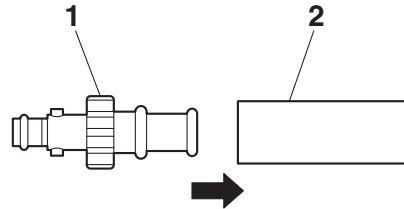

- 1 Garden hose adapter
- 2 Garden hose

- (4) Loosen the flushing hose connector cap and remove it. Insert the garden hose adapter into the flushing hose connector by pushing and twisting it until it is securely connected.

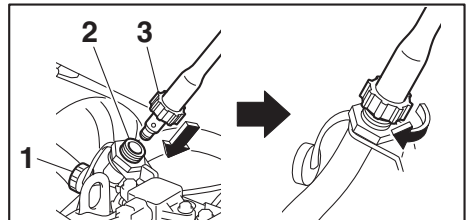

- 1 Flushing hose connector cap
- 2 Flushing hose connector
- 3 Garden hose adapter

- (5) Connect the garden hose to a water tap.
- (6) Make sure that the area around the watercraft is clear, and then start the engine. Immediately after the engine starts, fully turn the water supply on so that wa-

# Care and storage

ter flows out continually from the jet thrust nozzle.

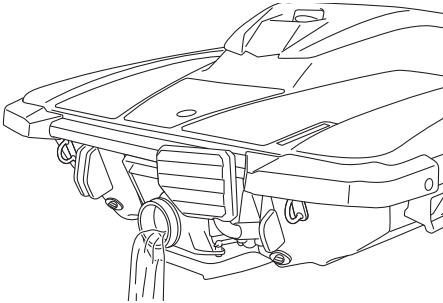

- (7) Run the engine at idling speed for about 3 minutes watching the engine condition. If the engine stops while flushing, turn the water supply off immediately and perform the procedure again from step 6. **NOTICE: Do not supply water to the cooling water passages when the engine is not running. The water could flow back through the muffler into the engine, causing severe engine damage.** [ECJ00123]
- (8) Turn the water supply off.
- (9) Discharge the remaining water out of the cooling water passages by alternately squeezing and releasing the throttle lever quickly for 10 to 15 seconds.
- (10) Stop the engine.
- (11) Remove the garden hose adapter, and then securely install the flushing hose connector cap by tightening it until it stops.
- (12) Securely install the seat storage compartment and seat in their original positions.

EJU44770

## Cleaning the watercraft

- (1) Remove the seat and fire extinguisher holder. (See page 38 for seat removal and installation procedures and page 43

for information on the fire extinguisher holder.)

- (2) If the watercraft will be stored for a week or more, rustproof the internal engine components to help prevent corrosion. (See page 81 for information on rust-proofing the internal engine components.)
- (3) Rinse the engine and engine compartment with a small amount of water. **NOTICE: Do not use high-pressure water when rinsing the engine or engine compartment as severe engine damage could result.** [ECJ00572]
- (4) Drain the water from the engine compartment. (See page 48 for information on draining the bilge water.)
- (5) Wipe the engine and engine compartment with a dry cloth.
- (6) Wash down the hull, deck, and jet pump with fresh water.
- (7) Wipe the hull, deck, and jet pump with a dry cloth.
- (8) Wipe all vinyl and rubber components, such as the seat and engine compartment seals, with a vinyl protectant.
- (9) To minimize corrosion, spray metallic parts of the hull, deck, and engine with a rust inhibitor.
- (10) Allow the engine compartment to air dry completely before installing the seat.
- (11) Securely install the fire extinguisher holder and seat in their original positions.

EJU33688

## Battery care

If the watercraft will not be used for more than a month, remove the battery from the watercraft, check it, and then store it in a cool, dry place.

EWJ00792



**Battery electrolyte is poisonous and dangerous, causing severe burns, etc. Electrolyte contains sulfuric acid. Avoid contact with skin, eyes, or clothing.**

### Antidotes

**External:** Flush with water.

**Internal:** Drink large quantities of water or milk. Follow with milk of magnesia, beaten egg, or vegetable oil. Call a physician immediately.

**Eyes:** Flush with water for 15 minutes and get prompt medical attention.

**Batteries produce explosive gases. Keep sparks, flames, cigarettes, etc., well away. If using or charging the battery in an enclosed space, make sure that it is well ventilated. Always shield your eyes when working near batteries.**

**Keep out of the reach of children.**

### To remove the battery:

- (1) Disconnect the negative (-) battery lead.
- (2) Disconnect the positive (+) battery lead.
- (3) Disconnect the breather hose.
- (4) Unhook the battery bands, and then remove the battery from the watercraft.

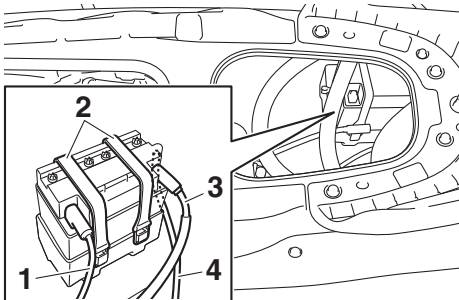

- 1 Negative (-) battery terminal: Black lead
- 2 Battery band
- 3 Positive (+) battery terminal: Red lead
- 4 Breather hose

### Checking the battery

- Make sure that the battery case is not damaged.
- Make sure that the battery terminals are not corroded or damaged.
- Make sure that the breather hose is not clogged or damaged.

### Checking the electrolyte level

Make sure that the electrolyte level is between the maximum and minimum level marks.

If the electrolyte level is low, add distilled water to raise it to the specified level. **NOTICE:** Use only distilled water for replenishing the battery, otherwise battery life could be shortened. [ECJ00242]

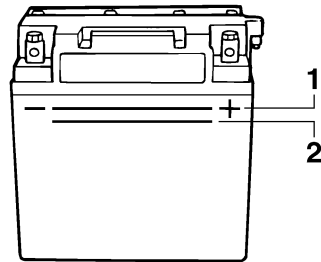

- 1 Maximum level mark
- 2 Minimum level mark

If distilled water was added, check the battery voltage.

It is recommended to have a Yamaha dealer check the battery voltage and charge the battery. If you charge the battery yourself, be sure to read and follow the instructions provided with the battery tester and charger you use. **NOTICE:** Do not attempt to charge a battery hastily. Battery life could be shortened. [ECJ00252]

# Care and storage

---

## Checking the battery bands

Make sure that the battery bands are not damaged.

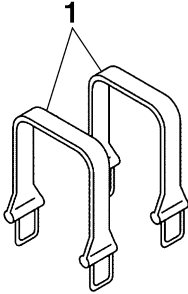

1 Battery band

## To store the battery:

- (1) Clean the battery case using fresh water.
- (2) If the battery terminals are dirty or corroded, clean them using a wire brush.

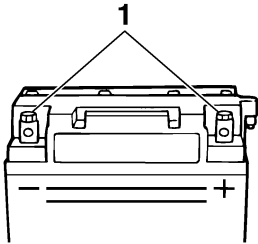

1 Battery terminal

- (3) Apply water-resistant grease to the battery terminals.

Recommended water-resistant grease:  
YAMALUBE MARINE  
GREASE/Yamaha Grease A

- (4) Store the battery in a cool, dry place.  
**NOTICE: Storing the battery in an uncharged condition can cause permanent battery damage. Check the battery periodically.** [ECJ00103]

## To install the battery:

- (1) Place the battery in the battery compartment and hook the battery bands onto the holders.
- (2) Connect the positive (+) battery lead (red) to the positive (+) battery terminal.  
**NOTICE: Reversal of the battery leads will damage the electrical parts.** [ECJ00262]
- (3) Connect the negative (-) battery lead (black) to the negative (-) battery terminal.
- (4) Connect the breather hose to the battery. **WARNING! Fire or explosion could result if the breather hose is damaged, obstructed, or not connected properly.** [EWJ00452]
- (5) Make sure that the battery is securely held in place.

EJU33493

## Long-term storage

EWJ00331

### **WARNING**

Always place the watercraft upright in a horizontal position when storing it, otherwise fuel could leak out into the engine or engine compartment, which could create a fire hazard.

Storage for long periods of time, such as winter storage, requires preventive maintenance to ensure against deterioration. It is advisable to have the watercraft serviced by a Yamaha dealer prior to storage.

However, the following procedures can be performed easily by the owner.

EJU40763

### **Cleaning**

- (1) Flush the cooling water passages. (See page 76 for information on flushing the cooling water passages.)

### **TIP:**

If you will be storing the watercraft for a prolonged period, such as winter storage, top off the fuel tank with fresh gasoline and add fuel stabilizer and conditioner to the fuel tank according to the manufacturer's instruction before starting the engine.

- (2) Clean the watercraft. (See page 77 for information on cleaning the watercraft.)  
Wax the hull with a non-abrasive wax.

EJU44402

### **Lubrication**

To keep moving parts sliding or rotating smoothly, lubricate them with water-resistant grease.

Recommended water-resistant grease:  
YAMALUBE MARINE GREASE /  
Yamaha Grease A

- Steering cable (jet thrust nozzle end)

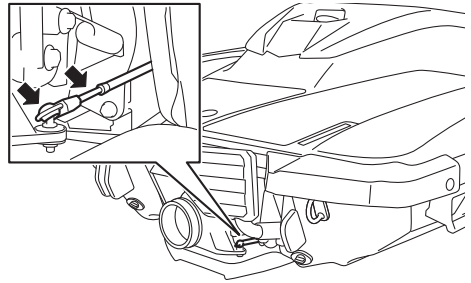

- EX Sport: Shift cable (reverse gate end) and ball joint

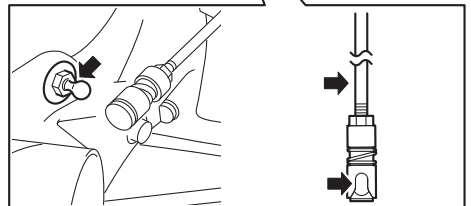
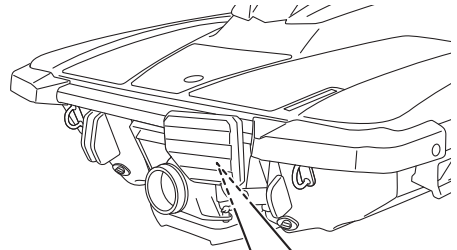

### **TIP:**

Disconnect the shift cable from the ball joint before lubricating.

# Care and storage

- EX Deluxe: Shift rod (reverse gate end) and ball joint

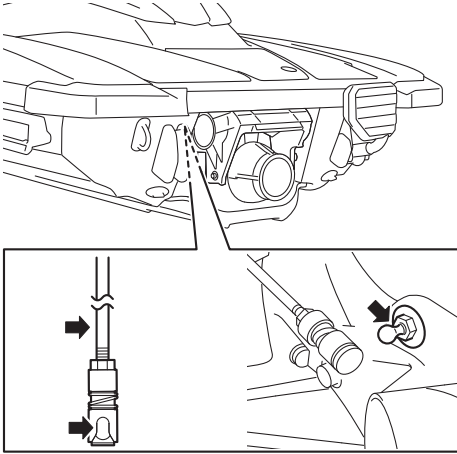

## TIP:

Disconnect the shift rod from the ball joint before lubricating.

EJ44790

## Rustproofing

### Rustproofing the hull, deck, and engine

Spray metallic parts of the hull, deck, and engine with a rust inhibitor.

### Rustproofing the internal engine components

Rustproof the internal engine components with a rust inhibitor.

To rustproof the internal engine components:

- (1) Remove the seat and fire extinguisher holder. (See page 38 for seat removal and installation procedures and page 43 for information on the fire extinguisher holder.)
- (2) Remove the plastic tie that is fastening the fuel hose to the holder on the starboard side of the air filter case.

- (3) Release the hooks on the port side of the air filter case, and remove the air filter case cover.

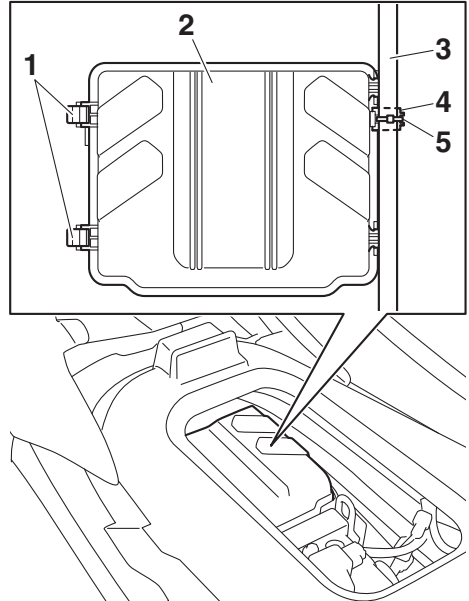

- 1 Hook
- 2 Air filter case cover
- 3 Fuel hose
- 4 Holder
- 5 Plastic tie

- (4) Spray a rust inhibitor into the intake opening for 3 seconds. **WARNING! Do not spray flammable rust inhibitor products on engine surfaces while the**



**engine is hot. The sprayed substance or propellants could catch fire.** [EWJ00262]

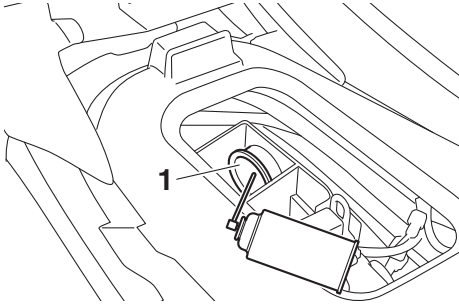

**1** Intake opening

- (5) Place the air filter case cover in its original position, and then fit the hooks onto the cover.

**TIP:**

Make sure that the air filter case cover is securely installed.

- (6) Fasten the fuel hose to the holder using the plastic tie.
- (7) Make sure that the area around the watercraft is clear, and then start the engine in a well-ventilated area and let it run at idle for 15 seconds. (See page 25 for information on starting the engine.)
- (8) Stop the engine.
- (9) Securely install the fire extinguisher holder and seat in their original positions.

# Maintenance

---

EJU33769

## Maintenance

Periodic checks and lubrication will keep your watercraft in the safest and most efficient condition possible. Therefore, make sure to carry out the periodic maintenance. Safety is an obligation of the watercraft owner. Proper maintenance must be carried out to keep the exhaust emission and sound levels within the regulated limits. The most important points of watercraft inspection and lubrication are explained on the following pages.

See a Yamaha dealer for genuine Yamaha replacement parts and optional accessories designed for your watercraft.

Remember, failures that are the result of the installation of parts or accessories which are not qualitatively equivalent to genuine Yamaha parts are not covered by the limited warranty.

**Maintenance, replacement, or repair of the emission control devices and system may be performed by any marine SI engine repair establishment or individual. Warranty repair, however, must be performed at an authorized Yamaha marine dealership.**

EWJ00312



**Be sure to turn off the engine when you perform maintenance unless otherwise specified. If you are not familiar with machine servicing, this work should be done by a Yamaha dealer or other qualified mechanic.**

---

EJU43101

## Periodic maintenance chart

The periodic maintenance chart gives general guidelines for periodic maintenance. Have a Yamaha dealer perform the checks in the following chart. However, maintenance may need to be performed more frequently depending on your operating conditions. If you have any questions, consult a Yamaha dealer.

This “√” mark indicates items to be checked and serviced by a Yamaha dealer.

Item	Operation	Initial	Thereafter every			Page
		10 hours	50 hours or 12 months *1	100 hours or 12 months *1	200 hours or 24 months *1	
Fuel line	Check fuel hoses and clamps			√		—
Fuel filler cap/Water separator	Check O-rings for cracks and deformation			√		—
Fuel tank	Check installation and straps			√		—
Water inlet strainer	Check for clogs and damage			√		—
Cooling water hoses	Check for damage and leakage, and check clamps			√		—
Engine oil	Replace	√		√		86
Oil filter	Replace			√		86
Spark plugs	Check	√		√		—
Battery	Check state of charge, terminals, bands, and breather hose			√		—
Battery leads	Check terminals			√		—
Steering master	Check operation and for looseness	√		√		—
Steering cable	Check exterior and connections, and lubricate			√		—
Shift lever (EX Sport)	Check exterior and connections, and lubricate			√		—
Shift cable and reverse gate (EX Sport)	Check exterior and connections, and lubricate			√		—
Shift rod and reverse gate (EX Deluxe)	Check exterior and connections, and lubricate			√		—
Air filter element	Check for damage and dirt			√		—
Air intake hoses	Check for damage, and check clamps			√		—

# Maintenance

Item	Operation	Initial	Thereafter every			Page
		10 hours	50 hours or 12 months *1	100 hours or 12 months *1	200 hours or 24 months *1	
<b>Throttle body</b>	Lubricate throttle valve			√		—
<b>Exhaust system</b>	Check for exhaust leakage, and check hoses and clamps			√		—
<b>Breather hose</b>	Check breather hose and clamps			√		—
<b>Impeller</b>	Check for bends, damage, and foreign material			√		—
<b>Jet thrust nozzle</b>	Check movement, and lubricate			√		—
<b>Jet vacuum bilge</b>	Check hoses for clogs and damage, check clamps, and clean bilge strainer			√		—
<b>Stern drain plugs</b>	Check O-rings			√		—
<b>Anode</b>	Check for corrosion, and clean				√ *2	—
<b>Valve clearance</b>	Check and adjust				√ *2	—
<b>Rubber coupling</b>	Check for cracks, indentations, looseness, and noise				√	—
<b>Engine mount</b>	Check for damage and peeling				√	—

\*1: Whichever comes first.

\*2: Check every 200 hours.

Perform the pre-operation checks and post-operation checks before performing periodic maintenance.

EJU36943

## Engine oil and oil filter

EWJ00341



**Engine oil is extremely hot immediately after the engine is turned off. Coming in contact with or getting any engine oil on your clothes could result in burns.**

---

ECJ00992

## **NOTICE**

**Do not run the engine with too much or not enough oil in the engine, otherwise the engine could be damaged.**

---

It is recommended to have a Yamaha dealer change the engine oil and the engine oil filter. However, if you choose to change the oil and filter on your own, consult a Yamaha dealer.

# Specifications

---

EJU45440

## Specifications

### Watercraft capacity:

Maximum people on board:

3 person

Maximum load capacity:

220 kg (485 lb)

### Dimensions and weight:

Length:

3130 mm (123.2 in) (EX)

3140 mm (123.6 in) (EX Sport / EX Deluxe)

Width:

1130 mm (44.5 in)

Height:

1150 mm (45.3 in)

Dry weight:

262 kg (578 lb) (EX)

265 kg (584 lb) (EX Sport)

272 kg (600 lb) (EX Deluxe)

### Performance:

Maximum output (according to ISO 8665/SAE J1228):

74.6 kW at 7300 r/min

Maximum fuel consumption:

28.5 L/h (7.5 US gal/h, 6.3 Imp.gal/h)

Cruising range at full throttle:

1.75 hour

Trolling speed:

1500 ±100 r/min

### Engine:

Engine type:

Liquid cooled 4-stroke, DOHC

Number of cylinders:

3

Engine displacement:

1049 cm<sup>3</sup>

Bore × stroke:

82.0 × 66.2 mm (3.23 × 2.61 in)

Compression ratio:

11.0 : 1

Valve clearance-intake (cold):

0.15–0.22 mm (0.0059–0.0087 in)

Valve clearance-exhaust (cold):

0.26–0.32 mm (0.0102–0.0126 in)

Lubrication system:

Dry sump

Cooling system:

Water

Starting system:

Electric

Ignition system:

T.C.I.

Spark plug (NGK):

CR9EB

Spark plug gap:

0.7–0.8 mm (0.028–0.031 in)

Battery capacity:

12 V, 19 Ah

Charging system:

Flywheel magneto

### Drive unit:

Propulsion system:

Jet pump

Jet pump type:

Axial flow, single stage

Impeller rotation:

Counterclockwise

Jet thrust nozzle angle:

24+24 °

### Fuel and oil:

Recommended fuel:

Regular unleaded gasoline

Minimum octane rating (PON):

86

Minimum octane rating (RON):

90

Recommended engine oil:

YAMALUBE 4W or 4-stroke motor oil



Recommended engine oil type SAE:

SAE 10W-30, 10W-40, 20W-40, 20W-50

Recommended engine oil grade API:

API SG, SH, SJ, SL

Fuel tank total capacity:

50 L (13.2 US gal, 11.0 Imp.gal)

Engine oil quantity with oil filter replacement:

3.4 L (3.59 US qt, 2.99 Imp.qt)

Engine oil quantity without oil filter replacement:

3.2 L (3.38 US qt, 2.82 Imp.qt)

Engine oil total quantity:

3.7 L (3.91 US qt, 3.26 Imp.qt)

# Trouble recovery

EJU34562

## Troubleshooting

If you have any trouble with your watercraft, use the troubleshooting chart to check for the possible cause.

If you cannot find the cause, consult a Yamaha dealer.

EJU44430

### Troubleshooting chart

Confirm the possible cause and remedy, and then refer to the applicable page.

TROUBLE	POSSIBLE CAUSE		REMEDY	PAGE
<b>Engine does not start (Starter motor does not turn over)</b>	Engine shut-off switch	Clip not in place	Install clip	25
	Fuse	Burned out	Have serviced by Yamaha dealer	—
	Battery	Run down	Recharge	77
		Poor terminal connections	Tighten as required	77
		Terminal corroded	Clean or replace	77
	Starter motor	Faulty	Have serviced by Yamaha dealer	—
<b>Engine does not start (Starter motor turns over)</b>	Throttle lever	Squeezed	Release	25
		Faulty	Have serviced by Yamaha dealer	—
	RiDE lever (EX Deluxe)	Squeezed	Release	25
		Faulty	Have serviced by Yamaha dealer	—
	Fuel	Fuel tank empty	Refill as soon as possible	44
		Stale or contaminated	Have serviced by Yamaha dealer	—
	Fuel tank	Water or dirt present	Have serviced by Yamaha dealer	—
	Spark plug	Fouled or defective	Have serviced by Yamaha dealer	—
	Fuel injection system	Fuel pump faulty	Have serviced by Yamaha dealer	—

# Trouble recovery

TROUBLE	POSSIBLE CAUSE		REMEDY	PAGE
<b>Engine runs irregularly or stalls</b>	Fuel	Fuel tank empty	Refill as soon as possible	44
		Stale or contaminated	Have serviced by Yamaha dealer	—
	Fuel tank	Water or dirt present	Have serviced by Yamaha dealer	—
	Spark plug	Fouled or defective	Have serviced by Yamaha dealer	—
		Incorrect heat range	Have serviced by Yamaha dealer	—
		Gap incorrect	Have serviced by Yamaha dealer	—
	Electrical wiring	Loose connection	Have serviced by Yamaha dealer	—
	Fuel injection system	Faulty or clogged injectors	Have serviced by Yamaha dealer	—
<b>Warning light or indicator blinks or comes on</b>	Fuel level warning	Fuel tank empty	Refill as soon as possible	44
	Oil pressure warning	Oil pressure dropped	Have serviced by Yamaha dealer	36
	Engine over-heat warning	Jet intake clogged	Clean	91
	Check engine warning	Faulty sensors	Have serviced by Yamaha dealer	37



# Trouble recovery

TROUBLE	POSSIBLE CAUSE		REMEDY	PAGE
<b>Watercraft slow or loses power</b>	Cavitation	Jet intake clogged	Clean	91
		Impeller damaged or worn	Have serviced by Yamaha dealer	91
	Engine over-heat warning	Engine speed reduction control activated	Clean jet intake and cool engine	36
	Oil pressure warning	Engine speed reduction control activated	Add oil	36
	Spark plug	Fouled or defective	Have serviced by Yamaha dealer	—
		Incorrect heat range	Have serviced by Yamaha dealer	—
		Gap incorrect	Have serviced by Yamaha dealer	—
	Electrical wiring	Loose connection	Have serviced by Yamaha dealer	—
	Fuel	Stale or contaminated	Have serviced by Yamaha dealer	—
	Air filter	Clogged	Have serviced by Yamaha dealer	—
		Oil buildup	Have serviced by Yamaha dealer	—
	Throttle lever	Faulty	Have serviced by Yamaha dealer	—

# Trouble recovery

EJU34625

## Emergency procedures

EJU44590

### Cleaning the jet intake and impeller

EWJ00783

#### **WARNING**

Before attempting to remove weeds or debris from the jet intake or impeller area, shut the engine off and remove the clip from the engine shut-off switch. Severe injury or death could result from coming in contact with the rotating parts of the jet pump.

If weeds or debris gets caught in the jet intake or impeller, cavitation can occur, causing jet thrust to decrease even though engine speed rises. If this condition is allowed to continue, the engine will overheat and may seize. **NOTICE: If weeds or debris gets caught in the jet intake, do not operate the watercraft above trolling speed until they have been removed.** [ECJ00654]

If there is any sign that the jet intake or impeller is clogged with weeds or debris, return to shore and check the intake and impeller. Al-

ways stop the engine before beaching the watercraft.

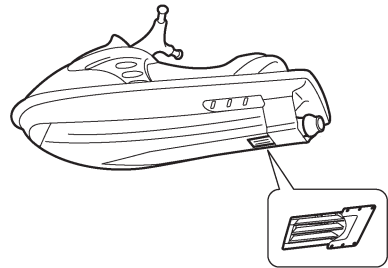
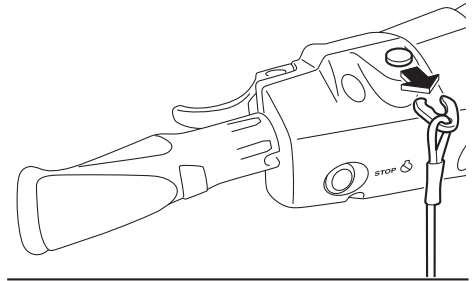

- (1) Place a suitable clean cloth or carpeting underneath the watercraft to protect it from abrasions and scratches. Turn the watercraft on its side as shown. **NOTICE: When turning the watercraft on its side, support the bow so that the handlebars are not bent or damaged.** [ECJ02690]

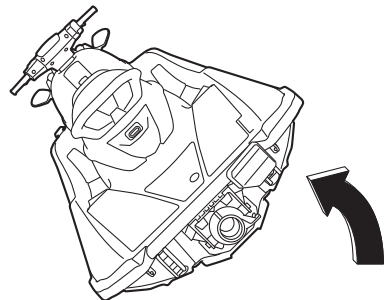

- (2) Remove any weeds or debris from around the jet intake, drive shaft, impel-

# Trouble recovery

ler, jet pump housing, and jet thrust nozzle.

If debris is difficult to remove, consult a Yamaha dealer.

EJU43472

## Raising the reverse gate (EX Deluxe)

If the RiDE system malfunctions and the reverse gate remains in the lowered position, the watercraft will not be able to move forward.

After raising the reverse gate so that the watercraft can move forward, immediately return to shore and have a Yamaha dealer service the watercraft.

### To raise the reverse gate:

- (1) Stop the engine and remove the clip from the engine shut-off switch.
- (2) Enter the water and move to the rear of the watercraft.
- (3) Slide the shift rod joint toward the bow, and then disconnect the shift rod joint from the ball joint.

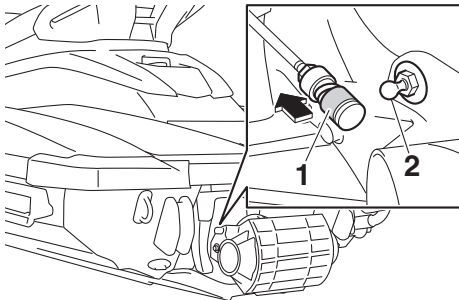

- 1 Shift rod joint
- 2 Ball joint

- (4) Raise the reverse gate to the forward position.

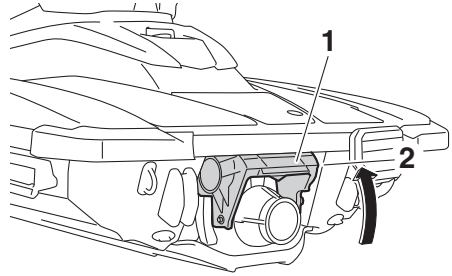

- 1 Reverse gate
- 2 Forward position

### TIP:

- While the shift rod is disconnected, the reverse gate will not move to the neutral position or reverse position even if the RiDE lever is squeezed.
- If the RiDE lever is squeezed while the shift rod is disconnected, the watercraft will move forward.

EJU34642

## Jumping the battery

If the watercraft battery has run down, the engine can be started using a 12-volt booster battery and jumper cables.

EJU34664

## Connecting the jumper cables

EWJ01251

### **⚠ WARNING**

To avoid battery explosion and serious damage to the electrical system:

- Do not reverse the polarity of the jumper cables when connecting to the batteries.
- Do not connect the negative (-) jumper cable to the negative (-) terminal of the watercraft battery.
- Do not touch the positive (+) jumper cable to the negative (-) jumper cable.

# Trouble recovery

- (1) Connect the positive (+) jumper cable to the positive (+) battery terminals of both batteries.
- (2) Connect one end of the negative (-) jumper cable to the negative (-) battery terminal of the booster battery.
- (3) Connect the other end of the negative (-) jumper cable to an engine hanger.

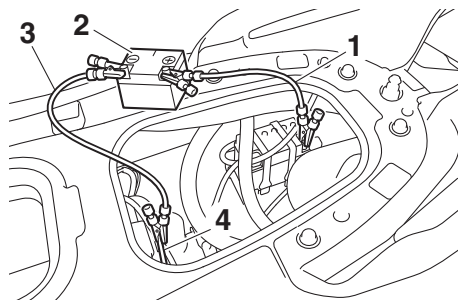

- 1 Positive (+) jumper cable
- 2 Booster battery
- 3 Negative (-) jumper cable
- 4 Engine hanger

- (4) Start the engine, and then disconnect the jumper cables by reversing the steps above. (See page 25 for information on starting the engine.)

EJU34716

## Towing the watercraft

EWJ00812

### WARNING

- The operator of the towing boat must keep speed to a minimum and avoid traffic or obstacles which could be a hazard to the operator on the watercraft.
- The towline should be long enough so that the watercraft will not collide with the towing boat when slowing down.

If the watercraft becomes inoperative in the water, it can be towed to shore.

### To tow the watercraft:

Use a towline that is three times the combined length of the towing boat and the watercraft.

- (1) Securely attach the towline to the bow eye of the watercraft being towed.

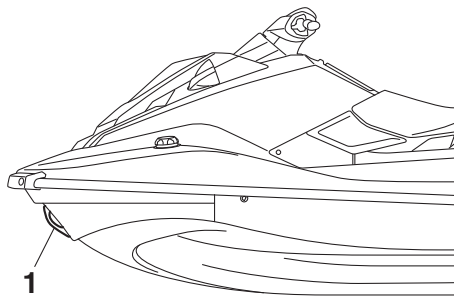

- 1 Bow eye

- (2) Sit astride the seat and hold on to the handlebars in order to balance the watercraft. **NOTICE: The bow must be kept up out of the water during towing, otherwise water could flood the engine compartment or water could flow back into the engine, causing severe engine damage.** [ECJ01331]

Tow the watercraft at 8 km/h (5 mph) or less.

**NOTICE: Tow the watercraft at 8 km/h (5 mph) or less, otherwise water could flood the engine compartment or water could flow back into the engine, causing severe engine damage.** [ECJ01322]

EJU42101

### Submerged watercraft

If the watercraft is submerged or flooded with water, drain the bilge water from the engine compartment. Then, have a Yamaha dealer service the watercraft as soon as possible.

If the watercraft was submerged:

- (1) Remove the watercraft from the water and drain the water from the storage compartments.

- (2) Drain the bilge water from the engine compartment. (See page 48 for information on draining the bilge water.)
- (3) Have the watercraft serviced by a Yamaha dealer as soon as possible.

**NOTICE: Be sure to have a Yamaha dealer inspect the watercraft. Otherwise, serious engine damage could result.** [ECJ00792]

# Index

---

<b>A</b>		
After removing the watercraft from the water .....	75	
<b>B</b>		
Battery care .....	77	
Battery checks .....	55	
Battery, jumping .....	92	
Beaching and docking the watercraft .....	74	
Bilge water check .....	55	
Bilge water, draining .....	48	
Bilge water, draining on land .....	48	
Bilge water, draining on water .....	49	
Boarding alone .....	70	
Boarding and starting off from a dock .....	73	
Boarding the watercraft .....	69	
Boarding with passenger(s) .....	70	
Bow eye .....	40	
Bow storage compartment .....	40	
Builder's plate .....	3	
<b>C</b>		
Capsized watercraft .....	73	
Check engine warning .....	37	
Cleaning .....	80	
Cleaning the watercraft .....	77	
Cleat .....	40	
Cooling water pilot outlet .....	27	
Cooling water pilot outlet check .....	60	
Craft Identification Number (CIN) .....	2	
Cruising limitations .....	11	
<b>E</b>		
Emergency procedures .....	91	
Engine break-in .....	51	
Engine compartment check .....	54	
Engine idling speed check .....	61	
Engine oil .....	46	
Engine oil and oil filter .....	86	
Engine oil level check .....	55	
Engine oil requirements .....	46	
Engine overheat warning .....	36	
Engine serial number .....	2	
Engine shut-off cord (lanyard) check .....	58	
Engine shut-off switch .....	25	
Engine stop switch .....	25	
Engine unit check .....	55	
Enjoy your watercraft responsibly .....	19	
Equipment .....	38	
<b>F</b>		
Fire extinguisher check .....	59	
Fire extinguisher holder .....	43	
Fire extinguisher holder checks .....	59	
Flushing the cooling water passages .....	76	
Fuel .....	44	
Fuel level check .....	54	
Fuel level meter .....	35	
Fuel level warning .....	36	
Fuel requirements .....	44	
Fuel system checks .....	54	
<b>G</b>		
Getting to know your watercraft .....	62	
Glossary, watercraft .....	20	
Glove compartment .....	41	
<b>H</b>		
Handgrip .....	38	
Hazard information .....	15	
Hood check .....	60	
Hour meter and voltmeter .....	34	
Hull and deck check .....	59	
<b>I</b>		
Identification numbers .....	1	
Information display .....	33	
<b>J</b>		
Jet intake and impeller, cleaning .....	91	
Jet intake checks .....	59	
Jet thrust nozzle and reverse gate check (EX Sport / EX Deluxe) .....	59	
Jumper cables, connecting .....	92	
<b>L</b>		
Labels, important .....	4	
Labels, other .....	9	
Labels, warning .....	5	
Launching the watercraft .....	63	
Learning to operate your watercraft .....	62	
Leaving the watercraft .....	64	
Limitations on who may operate the watercraft .....	10	
Long-term storage .....	80	
Lubrication .....	80	
<b>M</b>		
Main components, location of .....	21	
Maintenance .....	83	

Manufactured date label .....	2	Steering system .....	26
Model information .....	3	Steering system checks .....	56
Multifunction information center .....	33	Stern drain plug checks .....	59
Multifunction information center check ...	60	Stern eyes .....	40
<b>O</b>		Stopping the engine.....	64
Oil pressure warning .....	36	Stopping the watercraft .....	67
Operating in weeded areas .....	74	Storage compartment checks.....	59
Operating the watercraft .....	64	Storage compartments .....	40
Operating the watercraft in reverse or		Submerged watercraft .....	93
neutral (EX Sport / EX Deluxe) .....	68	Switch checks .....	58
Operating your watercraft .....	62	<b>T</b>	
Operation requirements .....	12	Tachometer .....	34
<b>P</b>		Throttle lever .....	26
Periodic maintenance chart .....	84	Throttle lever checks .....	58
Post-launch checks .....	60	Towing the watercraft .....	93
Post-operation care .....	76	Transporting on a trailer .....	50
Pre-launch checks .....	54	Troubleshooting .....	88
Pre-operation check points .....	54	Troubleshooting chart .....	88
Pre-operation checklist .....	52	Turning the watercraft .....	66
Primary Identification (PRI-ID) number .....	1	<b>W</b>	
<b>R</b>		Wakeboarding and water-skiing .....	17
Raising the reverse gate (EX Deluxe) .....	92	Water separator .....	27
Reboarding grip .....	39	Water separator check .....	55
Reboarding step		Watercraft characteristics .....	15
(EX Sport / EX Deluxe) .....	39	Watercraft control functions.....	25
Recommended equipment .....	14	Watercraft operation functions .....	29
Reverse system checks (EX Sport) .....	57		
Reverse system (EX Sport) .....	29		
RiDE lever checks (EX Deluxe).....	57		
RiDE lever (EX Deluxe) .....	26		
Riding position .....	63		
Rustproofing .....	81		
<b>S</b>			
Safe boating rules .....	18		
Safety equipment check .....	59		
Seat .....	38		
Seat storage compartment .....	42		
Shift indicator (EX Deluxe).....	34		
Shift system check (EX Deluxe) .....	61		
Shift system (EX Deluxe) .....	29		
Speedometer .....	33		
Start switch .....	25		
Starting off .....	72		
Starting off from a trailer .....	72		
Starting the engine on water.....	63		



Printed in U.S.A.  
June 2019-0.3 x 1 CR