



**OWNER'S MANUAL**

**max**

**125**

**YP125R**

**1B9-F819D-E2**



YAMAHA MOTOR ELECTRONICS CO., LTD.  
1450-6, Mori, Mori-machi, Shuchi-gun, Shizuoka-ken, 437-0292 Japan

## DECLARATION of CONFORMITY

We

Company: YAMAHA MOTOR ELECTRONICS CO., LTD.

Address: 1450-6, Mori, Mori-Machi, Shuchi-gun, Shizuoka-Ken, 437-0292 Japan

Hereby declare that the product:

Kind of equipment: IMMOBILIZER

Type-designation: 5SL-00

is in compliance with following norm(s) or documents:

R&TTE Directive(1999/5/EC)

EN300 330-2 v1.1.1(2001-6), EN60950-1(2001)

Two or Three-Wheel Motor Vehicles Directive(97/24/EC: Chapter 8, EMC)

Place of issue: Shizuoka, Japan

Date of issue: 1 Aug. 2002

### Revision record

| No. | Contents   | Date         |
|-----|--|--------------|
| 1   | To change contact person and integrate type-designation. | 9 Jun. 2005  |
| 2   | Version up the norm of EN60950 to EN60950-1              | 27 Feb. 2006 |
| 3   | To change company name                                   | 1 Mar. 2007  |
|     |  |              |

General manager of quality assurance div.

011 Mar / 2007

Welcome to the Yamaha world of motorcycling!

As the owner of the YP125R, you are benefiting from Yamaha's vast experience and newest technology regarding the design and manufacture of high-quality products, which have earned Yamaha a reputation for dependability.

Please take the time to read this manual thoroughly, so as to enjoy all advantages of your YP125R. The owner's manual does not only instruct you in how to operate, inspect and maintain your scooter, but also in how to safeguard yourself and others from trouble and injury.

In addition, the many tips given in this manual will help keep your scooter in the best possible condition. If you have any further questions, do not hesitate to contact your Yamaha dealer.



The Yamaha team wishes you many safe and pleasant rides. So, remember to put safety first!

# IMPORTANT MANUAL INFORMATION

---

EAU34111

Particularly important information is distinguished in this manual by the following notations:

|  |  |
|--|--|
|  | <b>The Safety Alert Symbol means ATTENTION! BECOME ALERT! YOUR SAFETY IS INVOLVED!</b>   |
|  | Failure to follow <b>WARNING</b> instructions <u>could result in severe injury or death</u> to the scooter operator, a bystander, or a person inspecting or repairing the scooter. |
| <b>CAUTION:</b>  | A <b>CAUTION</b> indicates special precautions that must be taken to avoid damage to the scooter.  |
| <b>NOTE:</b>   | A <b>NOTE</b> provides key information to make procedures easier or clearer.   |

## NOTE:

- This manual should be considered a permanent part of this scooter and should remain with it even if the scooter is subsequently sold.
- Yamaha continually seeks advancements in product design and quality. Therefore, while this manual contains the most current product information available at the time of printing, there may be minor discrepancies between your scooter and this manual. If you have any questions concerning this manual, please consult your Yamaha dealer.

EWA12410

## **WARNING**

---

**PLEASE READ THIS MANUAL CAREFULLY AND COMPLETELY BEFORE OPERATING THIS SCOOTER.**

---

\*Product and specifications are subject to change without notice.

# IMPORTANT MANUAL INFORMATION

---

EAUS1172

**YP125R  
OWNER'S MANUAL**  
©2007 by YAMAHA MOTOR ESPAÑA S.A.  
1st edition, November 2007  
All rights reserved.  
Any reprinting or unauthorized use  
without the written permission of  
YAMAHA MOTOR ESPAÑA S.A.  
is expressly prohibited.  
Printed in Nederland.

# TABLE OF CONTENTS

---

|                                    |      |                                       |      |   |      |
|------------------------------------|------|---------------------------------------|------|---|------|
| <b>SAFETY INFORMATION</b> .....    | 1-1  | Ignition circuit cut-off system ..... | 3-18 | Tires .....                             | 6-18 |
| Further safe-riding points .....   | 1-4  |                                       |      | Cast wheels .....                       | 6-20 |
| <b>DESCRIPTION</b> .....           | 2-1  | <b>PRE-OPERATION CHECKS</b> .....     | 4-1  | Front and rear brake lever free         |      |
| Left view .....                    | 2-1  | Pre-operation check list .....        | 4-2  | play .....                              | 6-20 |
| Right view .....                   | 2-2  |                                       |      | Checking the front and rear brake       |      |
| Controls and instruments .....     | 2-3  | <b>OPERATION AND IMPORTANT</b>        |      | pads .....                              | 6-21 |
| <b>INSTRUMENT AND CONTROL</b>      |      | <b>RIDING POINTS</b> .....            | 5-1  | Checking the brake fluid level .....    | 6-21 |
| <b>FUNCTIONS</b> .....             | 3-1  | Starting the engine .....             | 5-1  | Changing the brake fluid .....          | 6-22 |
| Immobilizer system .....           | 3-1  | Starting off .....                    | 5-2  | Checking and lubricating                |      |
| Main switch/steering lock .....    | 3-2  | Acceleration and deceleration .....   | 5-2  | the cables .....                        | 6-23 |
| Indicator and warning lights ..... | 3-3  | Braking .....                         | 5-3  | Checking and lubricating the            |      |
| Self-diagnosis device .....        | 3-4  | Tips for reducing fuel                |      | throttle grip and cable .....           | 6-23 |
| Speedometer .....                  | 3-4  | consumption .....                     | 5-3  | Lubricating the front and rear          |      |
| Fuel gauge .....                   | 3-5  | Engine break-in .....                 | 5-4  | brake levers .....                      | 6-23 |
| Coolant temperature gauge .....    | 3-5  | Parking .....                         | 5-4  | Checking and lubricating the            |      |
| Multi-function display .....       | 3-6  | <b>PERIODIC MAINTENANCE</b>           |      | centerstand and sidestand .....         | 6-24 |
| Anti-theft alarm (optional) .....  | 3-9  | <b>AND MINOR REPAIR</b> .....         | 6-1  | Checking the front fork .....           | 6-24 |
| Handlebar switches .....           | 3-9  | Owner's tool kit .....                | 6-1  | Checking the steering .....             | 6-25 |
| Front brake lever .....            | 3-10 | Periodic maintenance and              |      | Checking the wheel bearings .....       | 6-26 |
| Rear brake lever .....             | 3-11 | lubrication chart .....               | 6-3  | Battery .....                           | 6-26 |
| Fuel tank cap .....                | 3-11 | Removing and installing the           |      | Replacing the fuses .....               | 6-27 |
| Fuel .....                         | 3-12 | cowlings and panel .....              | 6-7  | Replacing a headlight bulb .....        | 6-29 |
| Catalytic converters .....         | 3-13 | Checking the spark plug .....         | 6-9  | Replacing a front turn signal light     |      |
| Seat .....                         | 3-14 | Engine oil .....                      | 6-10 | bulb .....                              | 6-30 |
| Storage compartments .....         | 3-14 | Final transmission oil .....          | 6-13 | Replacing a tail/brake light bulb       |      |
| Front storage compartment .....    | 3-15 | Coolant .....                         | 6-14 | or a rear turn signal light bulb .....  | 6-30 |
| Rear storage compartment .....     | 3-16 | Air filter and V-belt case air filter |      | Replacing the license plate light       |      |
| Adjusting the shock absorber       |      | elements .....                        | 6-15 | bulb .....                              | 6-32 |
| assemblies .....                   | 3-17 | Adjusting the throttle cable free     |      | Replacing an auxiliary light bulb ..... | 6-32 |
| Sidestand .....                    | 3-18 | play .....                            | 6-17 | Troubleshooting .....                   | 6-32 |
|                                    |      | Valve clearance .....                 | 6-17 | Troubleshooting charts .....            | 6-33 |

# TABLE OF CONTENTS

---

---

|                                       |         |
|---------------------------------------|---------|
| <b>SCOOTER CARE AND STORAGE</b> ..... | 7-1     |
| Care .....                            | 7-1     |
| Storage .....                         | 7-3     |
| Matte color caution.....              | 7-4     |
| <br><b>SPECIFICATIONS</b> .....       | <br>8-1 |
| <br><b>CONSUMER INFORMATION</b> ..... | <br>9-1 |
| Identification numbers .....          | 9-1     |

# SAFETY INFORMATION

---

EAU10261

SCOOTERS ARE SINGLE TRACK VEHICLES. THEIR SAFE USE AND OPERATION ARE DEPENDENT UPON THE USE OF PROPER RIDING TECHNIQUES AS WELL AS THE EXPERTISE OF THE OPERATOR. EVERY OPERATOR SHOULD KNOW THE FOLLOWING REQUIREMENTS BEFORE RIDING THIS SCOOTER.

HE OR SHE SHOULD:

- OBTAIN THOROUGH INSTRUCTIONS FROM A COMPETENT SOURCE ON ALL ASPECTS OF SCOOTER OPERATION.
- OBSERVE THE WARNINGS AND MAINTENANCE REQUIREMENTS IN THE OWNER'S MANUAL.
- OBTAIN QUALIFIED TRAINING IN SAFE AND PROPER RIDING TECHNIQUES.
- OBTAIN PROFESSIONAL TECHNICAL SERVICE AS INDICATED BY THE OWNER'S MANUAL AND/OR WHEN MADE NECESSARY BY MECHANICAL CONDITIONS.

## Safe riding

- Always make pre-operation checks. Careful checks may help prevent an accident.
- This scooter is designed to carry the operator and passenger.
- The failure of motorists to detect and recognize scooters in traffic is the predominating cause of automobile/scooter accidents. Many accidents have been caused by an automobile driver who did not see the scooter. Making yourself conspicuous appears to be very effective in reducing the chance of this type of accident.

### Therefore:

- Wear a brightly colored jacket.
- Use extra caution when approaching and passing through intersections, since intersections are the most likely places for scooter accidents to occur.
- Ride where other motorists can see you. Avoid riding in another motorist's blind spot.
- Many accidents involve inexperienced operators. In fact, many operators who have been invol-

ved in accidents do not even have a current driver's license.

- Make sure that you are qualified and that you only lend your scooter to other qualified operators.
- Know your skills and limits. Staying within your limits may help you to avoid an accident.
- We recommend that you practice riding your scooter where there is no traffic until you have become thoroughly familiar with the scooter and all of its controls.
- Many accidents have been caused by error of the scooter operator. A typical error made by the operator is veering wide on a turn due to EXCESSIVE SPEED or undercornering (insufficient lean angle for the speed).
- Always obey the speed limit and never travel faster than warranted by road and traffic conditions.
- Always signal before turning or changing lanes. Make sure that other motorists can see you.



- The posture of the operator and passenger is important for proper control.
  - The operator should keep both hands on the handlebar and both feet on the footboard during operation to maintain control of the scooter.
  - The passenger should always hold onto the operator, the seat strap or grab bar, if equipped, with both hands and keep both feet on the passenger footrests.
  - Never carry a passenger unless he or she can firmly place both feet on the passenger footrests.
- Never ride under the influence of alcohol or other drugs.
- This scooter is designed for on-road use only. It is not suitable for off-road use.

### **Protective apparel**

The majority of fatalities from scooter accidents are the result of head injuries. The use of a safety helmet is the single most critical factor in the prevention or reduction of head injuries.

- Always wear an approved helmet.
- Wear a face shield or goggles. Wind in your unprotected eyes could contribute to an impairment of vision which could delay seeing a hazard.
- The use of a jacket, substantial shoes, trousers, gloves, etc., is effective in preventing or reducing abrasions or lacerations.
- Never wear loose-fitting clothes, otherwise they could catch on the control levers or wheels and cause injury or an accident.
- Never touch the engine or exhaust system during or after operation. They become very hot and can cause burns. Always wear protective clothing that covers your legs, ankles, and feet.
- Passengers should also observe the above precautions.

### **Modifications**

Modifications made to this scooter not approved by Yamaha, or the removal of original equipment, may render the scooter unsafe for use and

may cause severe personal injury. Modifications may also make your scooter illegal to use.

### **Loading and accessories**

Adding accessories or cargo to your scooter can adversely affect stability and handling if the weight distribution of the scooter is changed. To avoid the possibility of an accident, use extreme caution when adding cargo or accessories to your scooter. Use extra care when riding a scooter that has added cargo or accessories. Here are some general guidelines to follow if loading cargo or adding accessories to your scooter:

#### Loading

The total weight of the operator, passenger, accessories and cargo must not exceed the maximum load limit.

|   |
|---|
| <p><b>Maximum load:</b><br/>189 kg (417 lb)</p> |
|---|

When loading within this weight limit, keep the following in mind:

- Cargo and accessory weight should be kept as low and close

# SAFETY INFORMATION

1

to the scooter as possible. Make sure to distribute the weight as evenly as possible on both sides of the scooter to minimize imbalance or instability.

- Shifting weights can create a sudden imbalance. Make sure that accessories and cargo are securely attached to the scooter before riding. Check accessory mounts and cargo restraints frequently.
- Never attach any large or heavy items to the handlebar, front fork, or front fender. Such items can create unstable handling or a slow steering response.

## Accessories

Genuine Yamaha accessories have been specifically designed for use on this scooter. Since Yamaha cannot test all other accessories that may be available, you must personally be responsible for the proper selection, installation and use of non-Yamaha accessories. Use extreme caution when selecting and installing any accessories.

Keep the following guidelines in mind, as well as those provided under “Loading” when mounting accessories.

- Never install accessories or carry cargo that would impair the performance of your scooter. Carefully inspect the accessory before using it to make sure that it does not in any way reduce ground clearance or cornering clearance, limit suspension travel, steering travel or control operation, or obscure lights or reflectors.
- Accessories fitted to the handlebar or the front fork area can create instability due to improper weight distribution or aerodynamic changes. If accessories are added to the handlebar or front fork area, they must be as lightweight as possible and should be kept to a minimum.
- Bulky or large accessories may seriously affect the stability of the scooter due to aerodynamic effects. Wind may attempt to lift the scooter, or the scoo-

ter may become unstable in cross winds. These accessories may also cause instability when passing or being passed by large vehicles.

- Certain accessories can displace the operator from his or her normal riding position. This improper position limits the freedom of movement of the operator and may limit control ability, therefore, such accessories are not recommended.
- Use caution when adding electrical accessories. If electrical accessories exceed the capacity of the scooter’s electrical system an electric failure could result, which could cause a dangerous loss of lights or engine power.

## **Gasoline and exhaust gas**

- **GASOLINE IS HIGHLY FLAMMABLE:**
  - Always turn the engine off when refueling.
  - Take care not to spill any gasoline on the engine or exhaust system when refueling.



## Further safe-riding points

- Never refuel while smoking or in the vicinity of an open flame.
  - Never start the engine or let it run for any length of time in a closed area. The exhaust fumes are poisonous and may cause loss of consciousness and death within a short time. Always operate your scooter in an area that has adequate ventilation.
  - Always turn the engine off before leaving the scooter unattended and remove the key from the main switch. When parking the scooter, note the following:
    - The engine and exhaust system may be hot, therefore, park the scooter in a place where pedestrians or children are not likely to touch these hot areas.
    - Do not park the scooter on a slope or soft ground, otherwise it may fall over.
    - Do not park the scooter near a flammable source (e.g., a kerosene heater, or near an open flame), otherwise it could catch fire.
  - If you should swallow any gasoline, inhale a lot of gasoline vapor, or allow gasoline to get into your eyes, see your doctor immediately. If any gasoline spills on your skin or clothing, immediately wash the affected area with soap and water and change your clothes.
- Be sure to signal clearly when making turns.
  - Braking can be extremely difficult on a wet road. Avoid hard braking, because the scooter could slide. Apply the brakes slowly when stopping on a wet surface.
  - Slow down as you approach a corner or turn. Once you have completed a turn, accelerate slowly.
  - Be careful when passing parked cars. A driver might not see you and open a door in your path.
  - Railroad crossings, streetcar rails, iron plates on road construction sites, and manhole covers become extremely slippery when wet. Slow down and cross them with caution. Keep the scooter upright, otherwise it could slide out from under you.
  - The brake pads could get wet when you wash the scooter. After washing the scooter, check the brakes before riding.

## SAFETY INFORMATION

---

- Always wear a helmet, gloves, trousers (tapered around the cuff and ankle so they do not flap), and a bright colored jacket.
- Do not carry too much luggage on the scooter. An overloaded scooter is unstable.

1

## Left view

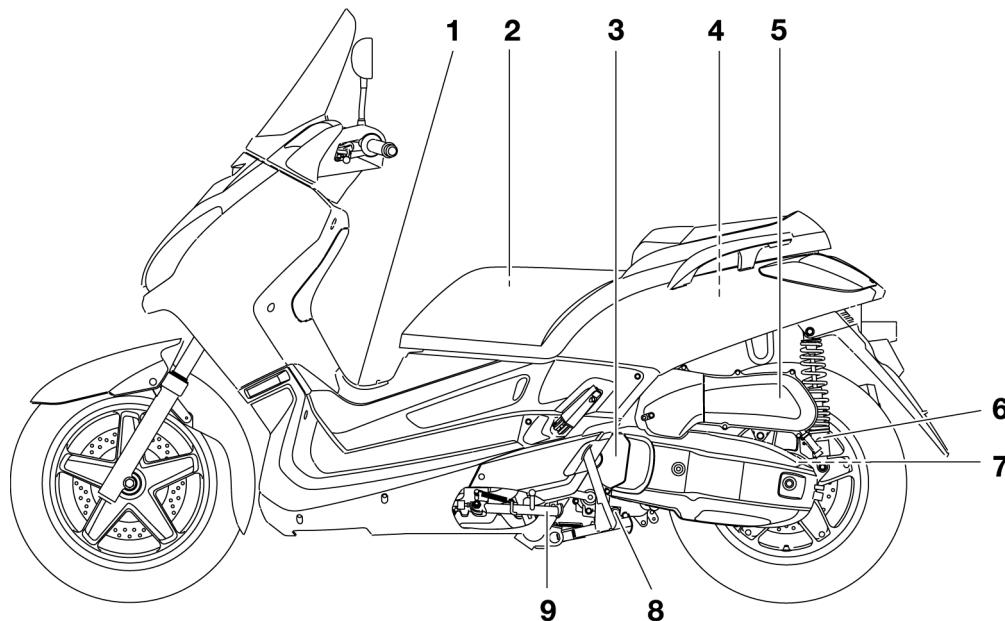

1. Fuel tank cap (page 3-11)
2. Owner's tool kit (page 6-1)
3. V-belt case air filter cover (page 6-15)
4. Rear storage compartment (page 3-16)
5. Air filter case cover (page 6-15)

6. Spring preload adjusting ring (page 3-17)
7. Final transmission oil filler cap (page 6-13)
8. Engine oil drain bolt (page 6-10)
9. Sidestand (page 3-18)

# DESCRIPTION

EAU10420

## Right view

2

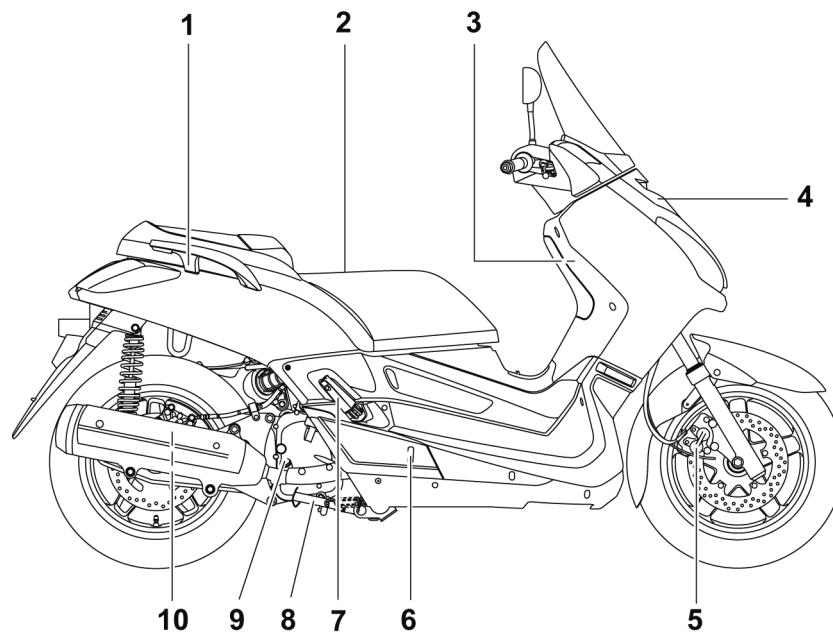

1. Grab bar
2. Seat (page 3-14)
3. Battery (page 6-26)
4. Fuses (page 6-27)
5. Front brake pads (page 6-21)

6. Coolant level window (page 6-14)
7. Passenger footrest
8. Centerstand (page 6-24)
9. Engine oil filler cap (page 6-10)
10. Rear brake pads (page 6-21)

## Controls and instruments

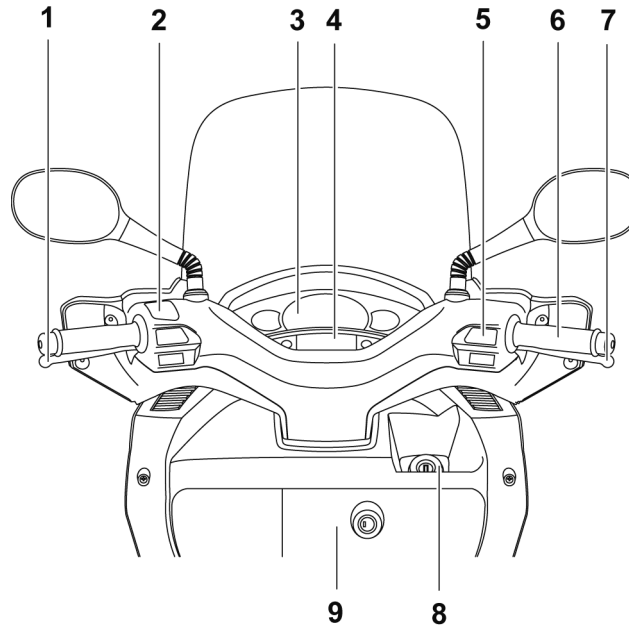

- 1. Rear brake lever (page 3-11)
- 2. Left handlebar switches (page 3-9)
- 3. Speedometer (page 3-4)
- 4. Multi-function display (page 3-6)
- 5. Right handlebar switches (page 3-9)

- 6. Throttle grip (page 5-2)
- 7. Front brake lever (page 3-10)
- 8. Main switch/Steering lock (page 3-2)
- 9. Front storage compartement (page 3-15)

# INSTRUMENT AND CONTROL FUNCTIONS

## Immobilizer system

EAU10974

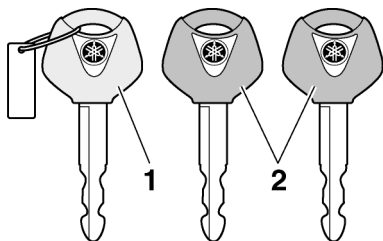

1. Code re-registering key (red bow)
2. Standard keys (black bow)

This vehicle is equipped with an immobilizer system to help prevent theft by re-registering codes in the standard keys. This system consists of the following.

- a code re-registering key (with a red bow)
- two standard keys (with a black bow) that can be re-registered with new codes
- a transponder (which is installed in the code re-registering key)
- an immobilizer unit
- an ECU (Electronic Control Unit)
- an immobilizer system indicator light (See page 3-3.)

The key with the red bow is used to register codes in each standard key. Since re-registering is a difficult process, take the vehicle along with all three keys to a Yamaha dealer to have them re-registered. Do not use the key with the red bow for driving. It should only be used for re-registering the standard keys. Always use a standard key for driving.

ECA11821

### CAUTION:

- **DO NOT LOSE THE CODE RE-REGISTERING KEY! CONTACT YOUR DEALER IMMEDIATELY IF IT IS LOST!** If the code re-registering key is lost, registering new codes in the standard keys is impossible. The standard keys can still be used to start the vehicle, however if code re-registering is required (i.e., if a new standard key is made or all keys are lost) the entire immobilizer system must be replaced. Therefore, it is highly recommended to use either standard key and keep the code re-registering key in a safe place.

- Do not submerge any key in water.
- Do not expose any key to excessively high temperatures.
- Do not place any key close to magnets (this includes, but not limited to, products such as speakers, etc.).
- Do not place items that transmit electrical signals close to any key.
- Do not place heavy items on any key.
- Do not grind any key or alter its shape.
- Do not disassemble the plastic part of any key.
- Do not put two keys of any immobilizer system on the same key ring.
- Keep the standard keys as well as keys of other immobilizer systems away from this vehicle's code re-registering key.
- Keep other immobilizer system keys away from the main switch as they may cause signal interference.



# INSTRUMENT AND CONTROL FUNCTIONS

EAU10471

## Main switch/steering lock

The main switch/steering lock controls the ignition and lighting systems, and is used to lock the steering.

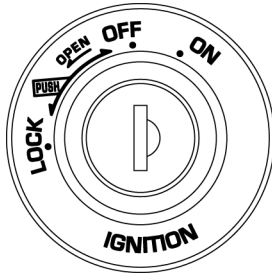

**NOTE:** Be sure to use the standard key (black bow) for regular use of the vehicle. To minimize the risk of losing the code re-registering key (red bow), keep it in a safe place and only use it for code re-registering.

EAU34121

## ON

All electrical circuits are supplied with power; the meter lighting, taillight, license plate light and auxiliary lights come on, and the engine can be started. The key cannot be removed.

**NOTE:** The headlights come on automatically when the engine is started and stay on until the key is turned to “OFF” or the sidestand is moved down.

EAU10660

## OFF

All electrical systems are off. The key can be removed.

EAU10680

## LOCK

The steering is locked, and all electrical systems are off. The key can be removed.

## To lock the steering

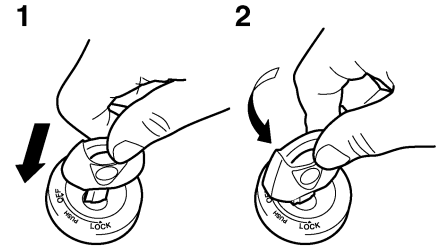

1. Push
2. Turn

1. Turn the handlebars all the way to the left.
2. Push the key in from the “OFF” position, and then turn it to “LOCK” while still pushing it.
3. Remove the key.

# INSTRUMENT AND CONTROL FUNCTIONS

To unlock the steering

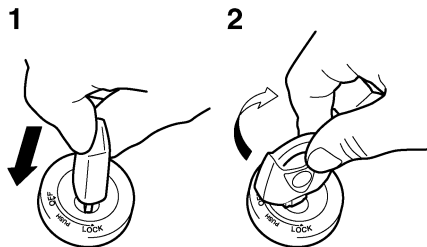

1. Push
2. Turn

Push the key in, and then turn it to “OFF” while still pushing it.

EWA10060





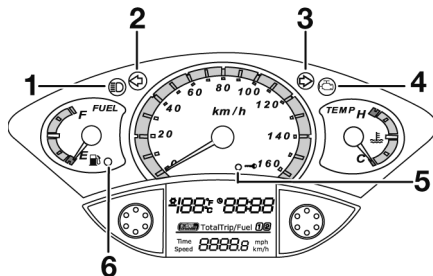

## **WARNING**

Never turn the key to “OFF” or “LOCK” while the vehicle is moving, otherwise the electrical systems will be switched off, which may result in loss of control or an accident. Make sure that the vehicle is stopped before turning the key to “OFF” or “LOCK”.

EAU11003

## Indicator and warning lights



1. High beam indicator light “”
2. Left turn signal indicator light “”
3. Right turn signal indicator light “”
4. Engine trouble warning light “”
5. Immobilizer system indicator light “”
6. Fuel level warning light “”

EAU11030

## Turn signal indicator lights “” and “”

The corresponding indicator light flashes when the turn signal switch is pushed to the left or right.

EAU11080

## High beam indicator light “”

This indicator light comes on when the high beam of the headlight is switched on.

EAU11350

## Fuel level warning light “”

This warning light comes on when the fuel level drops below approximately 2 L (0.53 US gal) (0.44 Imp.gal). When this occurs, refuel as soon as possible.

The electrical circuit of the warning light can be checked by turning the key to “ON”.

If the warning light does not come on for a few seconds, then go off, have a Yamaha dealer check the electrical circuit.

# INSTRUMENT AND CONTROL FUNCTIONS

EAU12090

## Self-diagnosis device

This model is equipped with a self-diagnosis device for various electrical circuits.

If any of those circuits are defective, the engine trouble warning light will come on or flash. If this occurs, have a Yamaha dealer check the vehicle.

ECA11170

### CAUTION:

**To prevent engine damage, be sure to consult a Yamaha dealer as soon as possible if this occurs.**

EAUT1931

## Engine trouble warning light “”

This warning light flashes or stays on when an electrical circuit monitoring the engine is defective. When this occurs, have a Yamaha dealer check the self-diagnosis system.

The electrical circuit of the warning light can be checked by turning the key to “ON”. If the warning light does not come on for a few seconds, then go off, have a Yamaha dealer check the electrical circuit.

EAU38620

## Immobilizer system indicator light “”

The electrical circuit of the indicator light can be checked by turning the key to “ON”.

If the indicator light does not come on for a few seconds, then go off, have a Yamaha dealer check the electrical circuit.

When the key is turned to “OFF” and 30 seconds have passed, the indicator light will start flashing indicating the immobilizer system is enabled. After 24 hours have passed, the indicator light will stop flashing, however the immobilizer system is still enabled.

EAU11591

## Speedometer



1. Speedometer

## UK ONLY

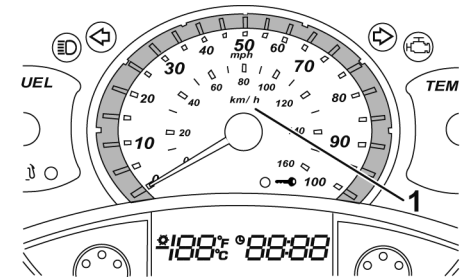

1. Speedometer

The speedometer shows the riding speed.

# INSTRUMENT AND CONTROL FUNCTIONS

EAU11470

## Fuel gauge

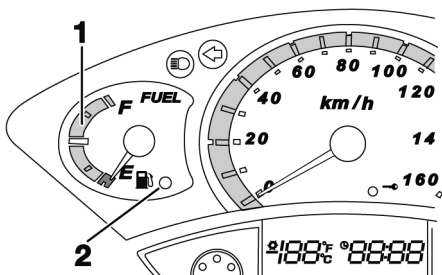

1. Fuel gauge
2. Fuel level warning light “”

The fuel gauge indicates the amount of fuel in the fuel tank. The needle moves towards “E” (Empty) as the fuel level decreases. When the remaining fuel in the tank reaches approximately 2 L (0.53 US gal) (0.44 Imp.gal), the fuel level warning light will come on and the multi-function display will automatically change to the “Trip/fuel” mode. (See page 3-6.) If this occurs, refuel as soon as possible.

**NOTE:** \_\_\_\_\_  
Do not allow the fuel tank to empty itself completely.  
\_\_\_\_\_

EAU12171

## Coolant temperature gauge

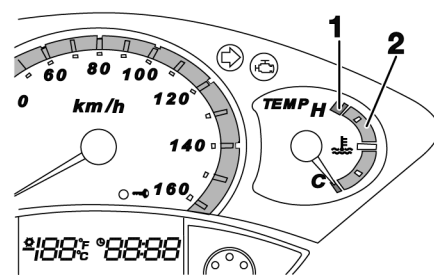

1. Red zone
2. Coolant temperature gauge

With the key in the “ON” position, the coolant temperature gauge indicates the temperature of the coolant. The coolant temperature varies with changes in the weather and engine load. If the needle reaches or enters the red zone, stop the vehicle and let the engine cool. (See page 6-34.)

ECA10020

### **CAUTION:** \_\_\_\_\_

**Do not operate the engine if it is overheated.**  
\_\_\_\_\_

# INSTRUMENT AND CONTROL FUNCTIONS

EAUM2050

## Multi-function display

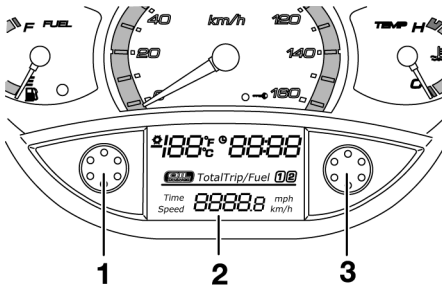

1. "MODE" button
2. Multi-function display
3. "SET" button

The multi-function display is equipped with the following:

- an odometer (which shows the total distance traveled)
- two tripmeters (which show the distance traveled since they were last set to zero, the time passed since the tripmeters were set to zero, and the average speed traveled during this time)
- a fuel reserve tripmeter (which shows the distance traveled since the fuel level warning light came on)

- a clock
- an ambient temperature display
- an oil change indicator (which comes on when the engine oil should be changed)

### NOTE:

- For the UK, the distance traveled is displayed in miles and the temperature reading is displayed in °F.
- For other countries, the distance traveled is displayed in kilometers and the temperature reading is displayed in °C.

### Odometer and tripmeter modes

Pushing the "MODE" button switches the display between the odometer mode "Total" and the tripmeter modes "Trip" in the following order: Total → Trip 1 → Trip 2 → Trip/fuel → Total

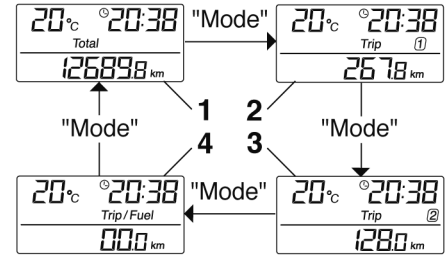

ZALM0391

1. Total
2. Trip 1
3. Trip 2
4. Trip/Fuel

### NOTE:

- The Trip/fuel odometer is only activated if the fuel level warning light comes on.
- The Trip 2 odometer is automatically reset after turning the key to "OFF" and two hours have passed.

Pushing the "SET" button when in the tripmeter mode switches the display between the different tripmeter functions in the following order:

Trip 1 or Trip 2 → Time 1 or 2 → Average speed 1 or 2 → Trip 1 or Trip 2

# INSTRUMENT AND CONTROL FUNCTIONS

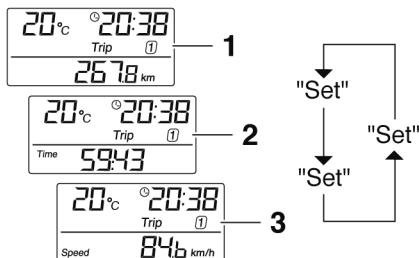

1. Distance
2. Time
3. Average speed

If the fuel level warning light comes on (See page 3-3.), the display will automatically change to the fuel reserve tripmeter mode "Trip/fuel" and start counting the distance traveled from that point. In that case, pushing the "MODE" button switches the display between the various tripmeter and odometer modes in the following order:

Trip/Fuel → Trip 1 → Trip 2 → Total  
→ Trip/fuel

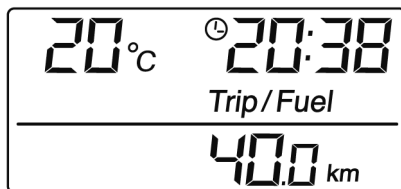

ZAJM0393

To reset a tripmeter, select it by pushing the "MODE" button, and then push the "SET" button for at least one second. If you do not reset the fuel reserve tripmeter manually, it will reset itself automatically and the display will return to the prior mode after refueling and traveling 5 km (3 mi).

## Clock mode

To set the clock:

1. When the display is in the "Total" mode, push the "SET" button for at least two seconds.
2. When the hour digits start flashing, push the "SET" button to set the hours.

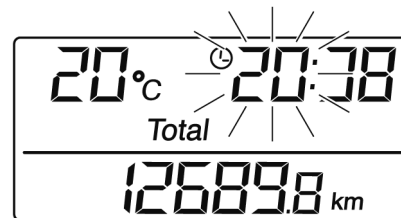

ZAJM0394

3. Push the "MODE" button, and the minute digits will start flashing.
4. Push the "SET" button to set the minutes.
5. Push the "MODE" button and then release it to start the clock. The display will return to the "Total" mode.

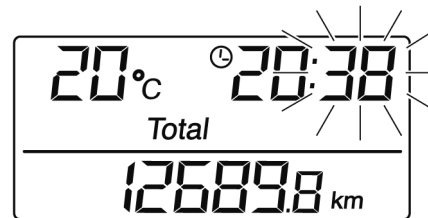

ZAJM0395

# INSTRUMENT AND CONTROL FUNCTIONS

## Ambient temperature display

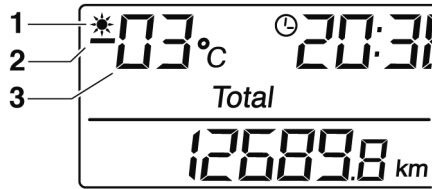

ZAUJ0396

1. Frost warning indicator “”
2. Negative symbol “-”
3. Ambient temperature

This display shows the ambient temperature from  $-30\text{ }^{\circ}\text{C}$  ( $-86\text{ }^{\circ}\text{F}$ ) to  $50\text{ }^{\circ}\text{C}$  ( $122\text{ }^{\circ}\text{F}$ ).

The frost warning indicator “” automatically comes on if the temperature is lower than  $3\text{ }^{\circ}\text{C}$  ( $37.4\text{ }^{\circ}\text{F}$ ).

## Oil change indicator “OIL”

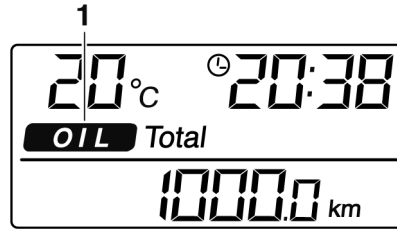

ZAUJ0582

1. Oil change indicator “OIL”

The engine oil should be changed when this indicator comes on. The indicator stays on until it is reset. After changing the engine oil, reset the indicator as follows.

1. While holding the “MODE” and “SET” buttons pushed, turn the key to “ON”.
2. Continue holding the “MODE” and “SET” buttons pushed for two to five seconds.
3. Release the buttons and the oil change indicator will go off.

## NOTE:

- The oil change indicator will come on at the initial 1000 km (600 mi), 5000 km (3000 mi) after the initial 1000 km (600 mi) and every 6000 km (3600 mi) thereafter.
- If the engine oil is changed before the oil change indicator comes on (i.e. before the periodic oil change interval has been reached), the indicator must be reset after the oil change for the next periodic oil change to be indicated at the correct time. After resetting, the indicator will come on for two seconds. If the indicator does not come on, repeat the procedure.

# INSTRUMENT AND CONTROL FUNCTIONS

EAU12331

## Anti-theft alarm (optional)

This model can be equipped with an optional anti-theft alarm by a Yamaha dealer. Contact a Yamaha dealer for more information.

3

EAU12347

## Handlebar switches

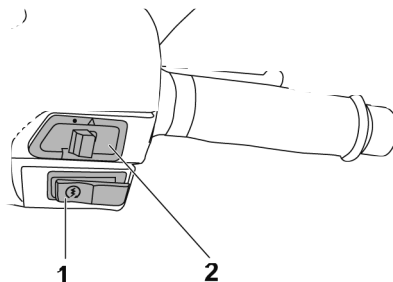

1. Start switch “ $\text{Ⓢ}$ ”
2. Hazard switch “ $\text{▲}$ ”

EAU51020

## Dimmer switch “ $\text{≡D/≡D}$ ”

Set this switch to “ $\text{≡D}$ ” for the high beam and to “ $\text{≡D}$ ” for the low beam. With the headlight on low beam, press this switch downwards to flash the headlight.

EAU12460

## Turn signal switch “ $\text{↔/↔}$ ”

To signal a right-hand turn, push this switch to “ $\text{↔}$ ”. To signal a left-hand turn, push this switch to “ $\text{↔}$ ”. When released, the switch returns to the center position. To cancel the turn signal lights, push the switch in after it has returned to the center position.

EAU12500

## Horn switch “ $\text{♫}$ ”

Press this switch to sound the horn.

EAUM1990

## Hazard switch “ $\text{▲}$ ”, “ $\text{⊙}$ ”

With the key in the “ON” position, set this switch to “ $\text{▲}$ ” to turn on the hazard lighting (simultaneous flashing of all turn signal lights). To turn off the hazard lighting, set this switch to “ $\text{⊙}$ ” and, then turn the key to “OFF”.

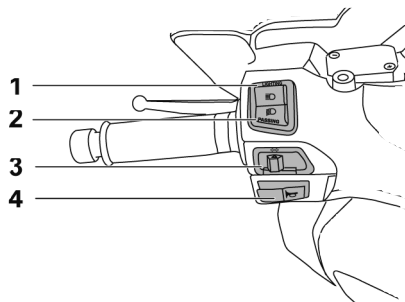

1. Dimmer switch “ $\text{≡D/≡D}$ ”
2. Pass switch “PASSING”
3. Turn signal switch “ $\text{↔/↔}$ ”
4. Horn switch “ $\text{♫}$ ”



# INSTRUMENT AND CONTROL FUNCTIONS

## NOTE:

Even if the key is turned from “ON” to “OFF” with the hazard lighting on, the hazard lighting will continue to flash regardless of the hazard switch position. To cancel the hazard lighting, the key must be turned to “ON” and the hazard switch must be set to the “

The hazard lighting is used in case of an emergency or to warn other drivers when your scooter is stopped where it might be a traffic hazard.

ECA10060

## CAUTION:

**Do not use the hazard light for an extended length of time, otherwise the battery may discharge.**

EAU12720

## Start switch “ With the sidestand up, push this switch while applying the front or rear brake to crank the engine with the starter.

ECA10050

## CAUTION:

**See page 5-1 for starting instructions prior to starting the engine.**

EAU12900

## Front brake lever

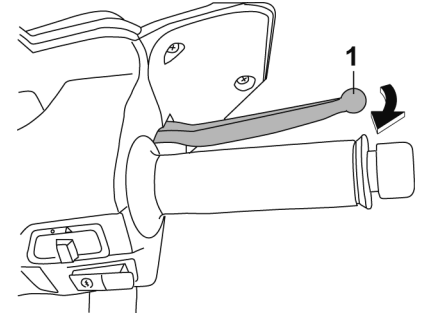

1. Front brake lever

The front brake lever is located on the right handlebar grip. To apply the front brake, pull this lever toward the handlebar grip.

# INSTRUMENT AND CONTROL FUNCTIONS

3

## Rear brake lever

EAU12950

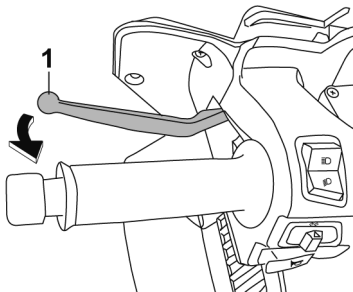

1. Rear brake lever

The rear brake lever is located on the left handlebar grip. To apply the rear brake, pull this lever toward the handlebar grip.

## Fuel tank cap

EAUT1382

### To remove the fuel tank cap

Open the lid by pulling the lever up.

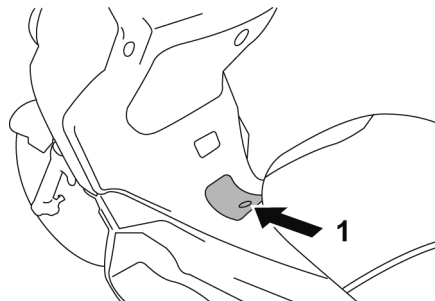

1. Push

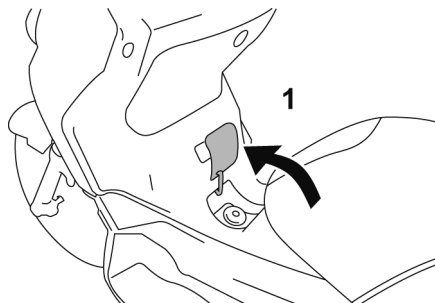

1. Open the lid

Insert the key into the fuel tank cap lock and turn it 1/4 turn counterclockwise. The lock will be released and the fuel tank cap can be removed.

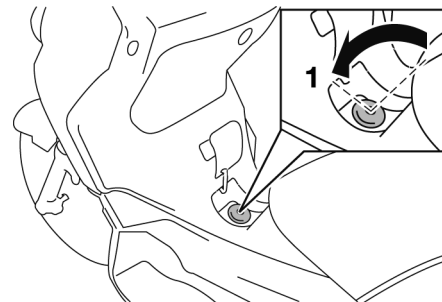

1. Open the fuel tank cap

### NOTE:

After removing the fuel tank cap, place it into the fuel tank cap holder as shown.

### To install the fuel tank cap

1. Insert the fuel tank cap into the fuel tank opening with the key inserted in the lock and the match marks aligned.
2. Turn the key clockwise to the original position, and then remove it.

# INSTRUMENT AND CONTROL FUNCTIONS

EAU13211

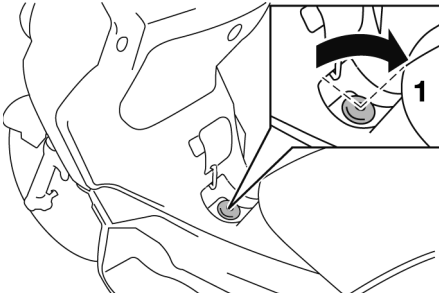

1. Close the fuel tank cap

## NOTE:

The fuel tank cap cannot be installed unless the key is in the lock. In addition, the key cannot be removed if the cap is not properly installed and locked.

3. Close the lid.

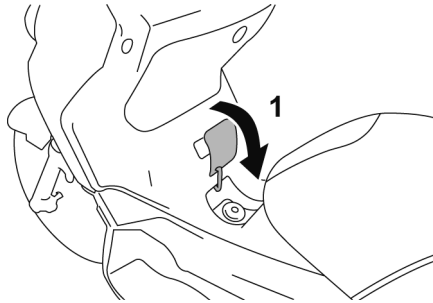

1. Close the lid

EWA10130

## WARNING

**Make sure that the fuel tank cap is properly installed before riding.**

## Fuel

Make sure that there is sufficient fuel in the tank. Fill the fuel tank to the bottom of the filler tube as shown.

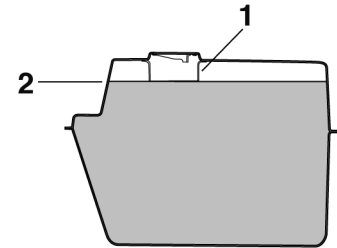

1. Fuel tank filler tube
2. Fuel level

ZALUM0020

EWA10880

## WARNING

- Do not overfill the fuel tank, otherwise it may overflow when the fuel warms up and expands.
- Avoid spilling fuel on the hot engine.

# INSTRUMENT AND CONTROL FUNCTIONS

ECA10070

## CAUTION:

Immediately wipe off spilled fuel with a clean, dry, soft cloth, since fuel may deteriorate painted surfaces or plastic parts.

or higher. If knocking (or pinging) occurs, use a gasoline of a different brand or premium unleaded fuel. Use of unleaded fuel will extend spark plug life and reduce maintenance costs.

EAU13442

## Catalytic converters

This vehicle is equipped with catalytic converters in the exhaust system.

EWA10860

## WARNING

The exhaust system is hot after operation. Make sure that the exhaust system has cooled down before doing any maintenance work.

ECA10700

## CAUTION:

The following precautions must be observed to prevent a fire hazard or other damages.

- Use only unleaded gasoline. The use of leaded gasoline will cause unreparable damage to the catalytic converter.
- Never park the vehicle near possible fire hazards such as grass or other materials that easily burn.
- Do not allow the engine to idle too long.

3

EAU33500

### Recommended fuel:

REGULAR UNLEADED GASOLINE ONLY

### Fuel tank capacity:

12.5 L (3.30 US gal) (2.75 Imp.gal)

### Fuel reserve amount (when the fuel level warning symbol comes on):

2 L (0.53 US gal) (0.44 Imp.gal)

ECA11400

## CAUTION:

Use only unleaded gasoline. The use of leaded gasoline will cause severe damage to internal engine parts, such as the valves and piston rings, as well as to the exhaust system.

Your Yamaha engine has been designed to use regular unleaded gasoline with a research octane number of 91

# INSTRUMENT AND CONTROL FUNCTIONS

EAU13932

## Seat

### To open the seat

1. Place the scooter on the centers-stand.
2. Insert the key into the main switch, and then turn it counter-clockwise to "OPEN".

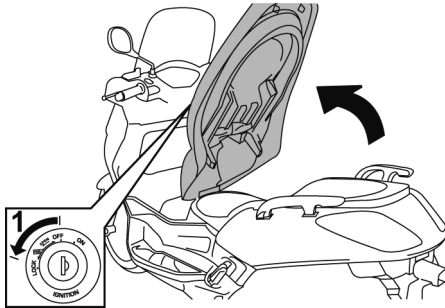

1. Open

### NOTE:

Do not push inward when turning the key.

3. Fold the seat up.

### To close the seat

1. Fold the seat down, and then push it down to lock it in place.

2. Remove the key from the main switch if the scooter will be left unattended.

### NOTE:

Make sure that the seat is properly secured before riding.

EAUT1711

## Storage compartments

### Front storage compartment

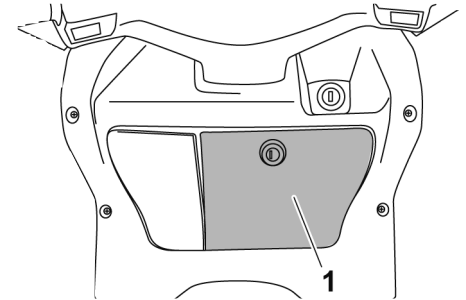

1. Front storage compartment

EWA11190

### ⚠ WARNING

- Do not exceed the load limit of 1 kg (2.2 lb) for the front storage compartment.
- Do not exceed the maximum load of 189 kg (417 lb) for the vehicle.

# INSTRUMENT AND CONTROL FUNCTIONS

## Rear storage compartment

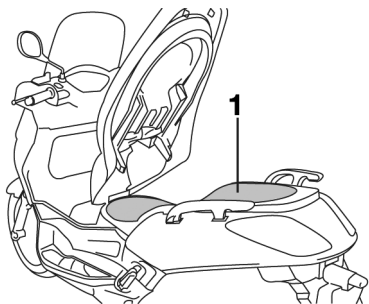

1. Rear storage compartment

The rear storage compartment is located under the seat. (See page 3-14.)

ECAT1030

### CAUTION:

Keep the following points in mind when using the rear storage compartment.

- Since the rear storage compartment accumulates heat when exposed to the sun, do not store anything susceptible to heat inside it.
- To avoid humidity from spreading through the rear storage

compartment, wrap wet articles in a plastic bag before storing them in the compartment.

- Since the rear storage compartment may get wet while the scooter is being washed, wrap any articles stored in the rear compartment in a plastic bag.
- Do not keep anything valuable or breakable in the rear storage compartment.

EWAT1050

### WARNING

- Do not exceed the load limit of 5 kg (11 lb) for the rear storage compartment.
- Do not exceed the maximum load of 189 kg (417 lb) for the vehicle.

EAU14541

## Front storage compartment To open the storage compartment

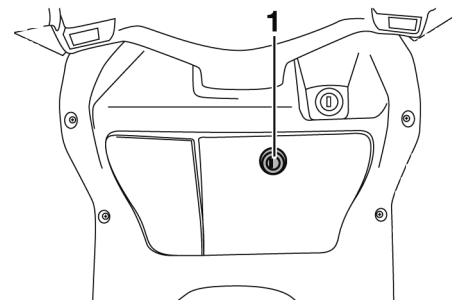

1. Lock

Insert the key into the lock, turn it clockwise, and then pull on it to open the storage compartment lid.

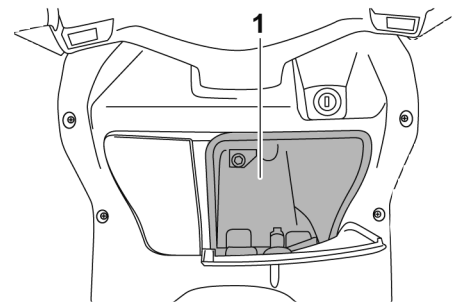

1. Front storage compartment

# INSTRUMENT AND CONTROL FUNCTIONS

**To close the storage compartment**  
Push the storage compartment lid into the original position, and then remove the key.

EWA10961

## **WARNING**

- Do not exceed the load limit of 1 kg (2.2 lb) for the storage compartment.
- Do not exceed the maximum load of 189 kg (417 lb) for the vehicle.

## Rear storage compartment

EAUT1060

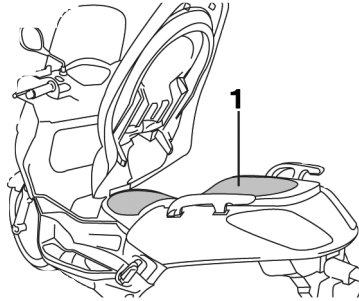

1. Rear storage compartment

There is a storage compartment under the seat.

EWA10960

## **WARNING**

- Do not exceed the load limit of 5 kg (11 lb) for the storage compartment.
- Do not exceed the maximum load of 189 kg (417 lb) for the vehicle.

ECA10080

## **CAUTION:**

Keep the following points in mind when using the storage compartment.

- Since the storage compartment accumulates heat when exposed to the sun, do not store anything susceptible to heat inside it.
- To avoid humidity from spreading through the storage compartment, wrap wet articles in a plastic bag before storing them in the compartment.
- Since the storage compartment may get wet while the scooter is being washed, wrap any articles stored in the compartment in a plastic bag.
- Do not keep anything valuable or breakable in the storage compartment.

To store two helmets in the storage compartment, place the helmets as shown.

# INSTRUMENT AND CONTROL FUNCTIONS

3

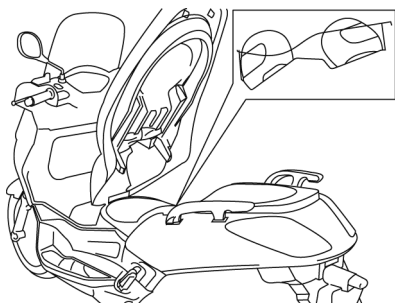

## NOTE:

- Some helmets cannot be stored in the storage compartment because of their size or shape.
- Do not leave your scooter unattended with the seat open.

## Adjusting the shock absorber assemblies

EAU14880

Each shock absorber assembly is equipped with a spring preload adjusting ring.

ECA10100

### CAUTION:

Never attempt to turn an adjusting mechanism beyond the maximum or minimum settings.

EWA10210

### WARNING

Always adjust both shock absorber assemblies equally, otherwise poor handling and loss of stability may result.

Adjust the spring preload as follows. To increase the spring preload and thereby harden the suspension, turn the adjusting ring on each shock absorber assembly in direction (a). To decrease the spring preload and thereby soften the suspension, turn the adjusting ring on each shock absorber assembly in direction (b).

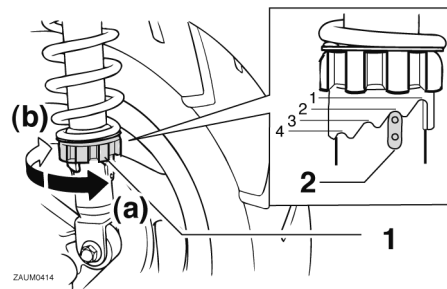

1. Spring preload adjusting ring
2. Position indicator

## NOTE:

Align the appropriate notch in the adjusting ring with the position indicator on the shock absorber.

### Spring preload setting:

Minimum (soft):

1

Standard:

1

Maximum (hard):

4



EAU15301

EWA10240

EAU15372

## Sidestand

The sidestand is located on the left side of the frame. Raise the sidestand or lower it with your foot while holding the vehicle upright.

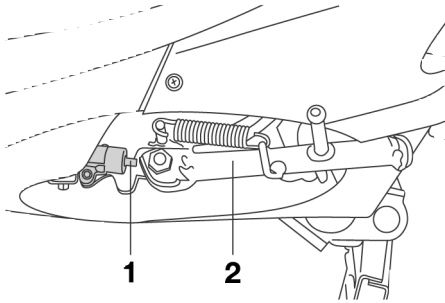

1. Sidestand switch
2. Sidestand

### NOTE:

The built-in sidestand switch is part of the ignition circuit cut-off system, which cuts the ignition in certain situations. (See further down for an explanation of the ignition circuit cut-off system.)

### **⚠ WARNING**

**The vehicle must not be ridden with the sidestand down, or if the sidestand cannot be properly moved up (or does not stay up), otherwise the sidestand could contact the ground and distract the operator, resulting in a possible loss of control. Yamaha's ignition circuit cut-off system has been designed to assist the operator in fulfilling the responsibility of raising the sidestand before starting off. Therefore, check this system regularly as described below and have a Yamaha dealer repair it if it does not function properly.**

## Ignition circuit cut-off system

The ignition circuit cut-off system (comprising the sidestand switch and brake light switches) has the following functions.

- It prevents starting when the sidestand is up, but neither brake is applied.
- It prevents starting when either brake is applied, but the sidestand is still down.
- It cuts the running engine when the sidestand is moved down.

Periodically check the operation of the ignition circuit cut-off system according to the following procedure.

### **⚠ WARNING**

**If a malfunction is noted, have a Yamaha dealer check the system before riding.**

EWA10250

# INSTRUMENT AND CONTROL FUNCTIONS

3

With the engine turned off:  
1. Move the sidestand down.  
2. Make sure that the engine stop switch is turned on.  
3. Turn the key on.  
4. Keep the front or rear brake applied.  
5. Push the start switch.  
**Does the engine start?**

NO YES

**NOTE:** \_\_\_\_\_  
This check is most reliable if performed with a warmed-up engine.  
\_\_\_\_\_

The sidestand switch may be defective.  
**The scooter should not be ridden** until checked by a Yamaha dealer.

With the engine still off:  
6. Move the sidestand up.  
7. Keep the front or rear brake applied.  
8. Push the start switch.  
**Does the engine start?**

YES NO

The brake switch may be defective.  
**The scooter should not be ridden** until checked by a Yamaha dealer.

With the engine still running:  
9. Move the sidestand down.  
**Does the engine stall?**

YES NO

The sidestand switch may be defective.  
**The scooter should not be ridden** until checked by a Yamaha dealer.

The system is OK. **The scooter can be ridden.**

# PRE-OPERATION CHECKS

---

EAU15593

The condition of a vehicle is the owner's responsibility. Vital components can start to deteriorate quickly and unexpectedly, even if the vehicle remains unused (for example, as a result of exposure to the elements). Any damage, fluid leakage or loss of tire air pressure could have serious consequences. Therefore, it is very important, in addition to a thorough visual inspection, to check the following points before each ride.

**NOTE:**

Pre-operation checks should be made each time the vehicle is used. Such an inspection can be accomplished in a very short time; and the added safety it assures is more than worth the time involved.

EWA11150

 **WARNING**

**If any item in the Pre-operation check list is not working properly, have it inspected and repaired before operating the vehicle.**

---

# PRE-OPERATION CHECKS

EAU15605

## Pre-operation check list

| ITEM                          | CHECKS  | PAGE              |
|-------------------------------|---|-------------------|
| <b>Fuel</b>                   | <ul style="list-style-type: none"><li>• Check fuel level in fuel tank.</li><li>• Refuel if necessary.</li><li>• Check fuel line for leakage.</li></ul>  | 3-11, 3-12        |
| <b>Engine oil</b>             | <ul style="list-style-type: none"><li>• Check oil level in engine.</li><li>• If necessary, add recommended oil to specified level.</li><li>• Check vehicle for oil leakage.</li></ul>   | 6-10              |
| <b>Final transmission oil</b> | <ul style="list-style-type: none"><li>• Check vehicle for oil leakage.</li></ul>  | 6-13              |
| <b>Coolant</b>                | <ul style="list-style-type: none"><li>• Check coolant level in reservoir.</li><li>• If necessary, add recommended coolant to specified level.</li><li>• Check cooling system for leakage.</li></ul>   | 6-14              |
| <b>Front brake</b>            | <ul style="list-style-type: none"><li>• Check operation.</li><li>• If soft or spongy, have Yamaha dealer bleed hydraulic system.</li><li>• Check brake pads for wear.</li><li>• Replace if necessary.</li><li>• Check fluid level in reservoir.</li><li>• If necessary, add recommended brake fluid to specified level.</li><li>• Check hydraulic system for leakage.</li></ul> | 3-10, 6-20 ~ 6-23 |
| <b>Rear brake</b>             | <ul style="list-style-type: none"><li>• Check operation.</li><li>• If soft or spongy, have Yamaha dealer bleed hydraulic system.</li><li>• Check brake pads for wear.</li><li>• Replace if necessary.</li><li>• Check fluid level in reservoir.</li><li>• If necessary, add recommended brake fluid to specified level.</li><li>• Check hydraulic system for leakage.</li></ul> | 3-11, 6-20 ~ 6-23 |
| <b>Throttle grip</b>          | <ul style="list-style-type: none"><li>• Make sure that operation is smooth.</li><li>• Check cable free play.</li><li>• If necessary, have Yamaha dealer adjust cable free play and lubricate cable and grip housing.</li></ul>  | 5-2, 6-17, 6-23   |
| <b>Wheels and tires</b>       | <ul style="list-style-type: none"><li>• Check for damage.</li><li>• Check tire condition and tread depth.</li><li>• Check air pressure.</li><li>• Correct if necessary.</li></ul>   | 6-18 ~ 6-20       |

# PRE-OPERATION CHECKS

| ITEM   | CHECKS  | PAGE              |
|--|---|-------------------|
| <b>Brake levers</b>                              | <ul style="list-style-type: none"><li>• Make sure that operation is smooth.</li><li>• Lubricate lever pivoting points if necessary.</li></ul>                             | 3-10 ~ 3-11, 6-20 |
| <b>Centerstand, sidestand</b>                    | <ul style="list-style-type: none"><li>• Make sure that operation is smooth.</li><li>• Lubricate pivots if necessary.</li></ul>  | 6-24              |
| <b>Chassis fasteners</b>                         | <ul style="list-style-type: none"><li>• Make sure that all nuts, bolts and screws are properly tightened.</li><li>• Tighten if necessary.</li></ul>                       | —                 |
| <b>Instruments, lights, signals and switches</b> | <ul style="list-style-type: none"><li>• Check operation.</li><li>• Correct if necessary.</li></ul>  | —                 |
| <b>Sidestand switch</b>                          | <ul style="list-style-type: none"><li>• Check operation of ignition circuit cut-off system.</li><li>• If system is defective, have Yamaha dealer check vehicle.</li></ul> | 3-18 ~ 3-19       |

# OPERATION AND IMPORTANT RIDING POINTS

EAU15980  
EWA10870

## ⚠ WARNING

- Become thoroughly familiar with all operating controls and their functions before riding. Consult a Yamaha dealer regarding any control or function that you do not thoroughly understand.
- Never start the engine or operate it in a closed area for any length of time. Exhaust fumes are poisonous, and inhaling them can cause loss of consciousness and death within a short time. Always make sure that there is adequate ventilation.
- For safety, always start the engine with the centerstand down.

EAUM2230

## Starting the engine

ECA10250

### CAUTION:

See page 5-4 for engine break-in instructions prior to operating the vehicle for the first time.

In order for the ignition circuit cut-off system to enable starting, the sidestand must be up.

EWA10290

### ⚠ WARNING

- Before starting the engine, check the function of the ignition circuit cut-off system according to the procedure described on page 3-18.
- Never ride with the sidestand down.

ECAM1080

1. Turn the key to "ON".

### CAUTION:

The following warning lights and indicator light should come on for a few seconds, then go off.

- Fuel level warning light
- Engine trouble warning light
- Immobilizer system indicator light

If a warning or indicator light does not go off, see page 3-3 for the corresponding warning and indicator light circuit check.

2. Close the throttle completely.
3. Start the engine by pushing the start switch while applying the front or rear brake.

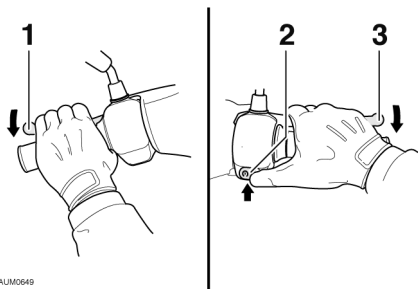

ZAUM0649

1. Rear brake lever
2. Start switch
3. Front brake lever

### NOTE:

If the engine does not start, release the start switch, wait a few seconds, and then try again. Each starting attempt should be as short as possible to preserve the battery. Do not

# OPERATION AND IMPORTANT RIDING POINTS

crank the engine more than 10 seconds on any one attempt. If the engine does not start, try with the throttle open 1/8 turn.

ECA11040

## CAUTION:

**For maximum engine life, never accelerate hard when the engine is cold!**

EAU16761

## Starting off

**NOTE:** Before starting off, allow the engine to warm up.

1. While pulling the rear brake lever with your left hand and holding the grab bar with your right hand, push the scooter off the centerstand.

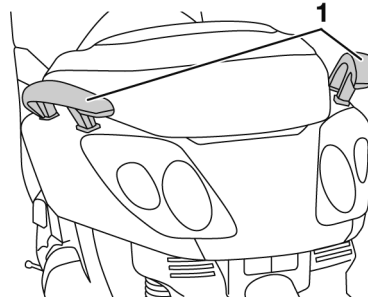

1. Grab bar

2. Sit astride the seat, and then adjust the rear view mirrors.
3. Switch the turn signals on.
4. Check for oncoming traffic, and then slowly turn the throttle grip (on the right) in order to take off.
5. Switch the turn signals off.

EAU16780

## Acceleration and deceleration

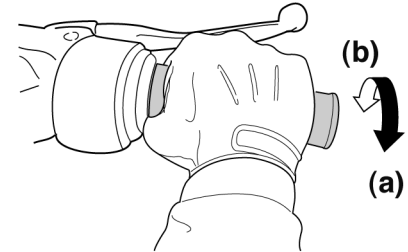

ZAJM0199

The speed can be adjusted by opening and closing the throttle. To increase the speed, turn the throttle grip in direction (a). To reduce the speed, turn the throttle grip in direction (b).

# OPERATION AND IMPORTANT RIDING POINTS

EAU16792

## Braking

1. Close the throttle completely.
2. Apply both front and rear brakes simultaneously while gradually increasing the pressure.

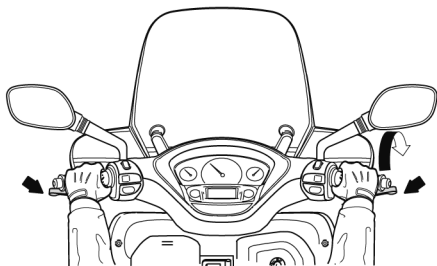

ZAUM0472

down when approaching such areas and cross them with caution.

- **Keep in mind that braking on a wet road is much more difficult.**
- **Ride slowly down a hill, as braking downhill can be very difficult.**

EAU16820

## Tips for reducing fuel consumption

Fuel consumption depends largely on your riding style. Consider the following tips to reduce fuel consumption:

- Avoid high engine speeds during acceleration.
- Avoid high engine speeds with no load on the engine.
- Turn the engine off instead of letting it idle for an extended length of time (e.g., in traffic jams, at traffic lights or at railroad crossings).

5

EWA10300

## **⚠ WARNING**

- **Avoid braking hard or suddenly (especially when leaning over to one side), otherwise the scooter may skid or overturn.**
- **Railroad crossings, streetcar rails, iron plates on road construction sites, and manhole covers become extremely slippery when wet. Therefore, slow**



# OPERATION AND IMPORTANT RIDING POINTS

EAU16830

## Engine break-in

There is never a more important period in the life of your engine than the period between 0 and 1000 km (600 mi). For this reason, you should read the following material carefully.

Since the engine is brand new, do not put an excessive load on it for the first 1000 km (600 mi). The various parts in the engine wear and polish themselves to the correct operating clearances. During this period, prolonged full-throttle operation or any condition that might result in engine overheating must be avoided.

EAUM2280

### 0 ~ 500 km (0 ~ 300 mi)

Avoid prolonged operation above 1/3 throttle.

### 500 ~ 1000 km (300 ~ 600 mi)

Avoid prolonged operation above 1/2 throttle.

EACAM1090

### CAUTION:

**After 1000 km (600 mi) of operation, the engine oil and final transmission oil must be changed, and the engine oil filter element replaced.**

### 1000 km (600 mi) and beyond

The vehicle can now be operated normally.

ECA10270

### CAUTION:

**If any engine trouble should occur during the engine break-in period, immediately have a Yamaha dealer check the vehicle.**

EAU17212

## Parking

When parking, stop the engine, and then remove the key from the main switch.

EWA10310

### ⚠ WARNING

- Since the engine and exhaust system can become very hot, park in a place where pedestrians or children are not likely to touch them.
- Do not park on a slope or on soft ground, otherwise the vehicle may overturn.

ECA10380

### CAUTION:

**Never park in an area where there are fire hazards such as grass or other flammable materials.**

# PERIODIC MAINTENANCE AND MINOR REPAIR

EAU17280

Safety is an obligation of the owner. Periodic inspection, adjustment and lubrication will keep your vehicle in the safest and most efficient condition possible. The most important points of inspection, adjustment, and lubrication are explained on the following pages.

The intervals given in the periodic maintenance and lubrication chart should be simply considered as a general guide under normal riding conditions. However, DEPENDING ON THE WEATHER, TERRAIN, GEOGRAPHICAL LOCATION, AND INDIVIDUAL USE, THE MAINTENANCE INTERVALS MAY NEED TO BE SHORTENED.

EWA10320

## **⚠ WARNING**

**If you are not familiar with maintenance work, have a Yamaha dealer do it for you.**

EWA10330

## **⚠ WARNING**

**This scooter is designed for use on paved roads only. If this scooter is operated in abnormally dusty, muddy or wet conditions, the air filter element should be cleaned or replaced more frequently, otherwise rapid engine wear may result. Consult a Yamaha dealer for proper maintenance intervals.**

EAU17520

## Owner's tool kit

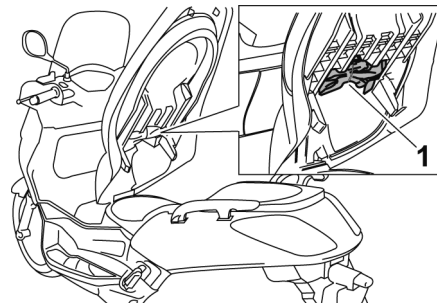

1. Owner's tool kit

The owner's tool kit is located inside the storage compartment under the seat. (See page 3-14.)

The service information included in this manual and the tools provided in the owner's tool kit are intended to assist you in the performance of preventive maintenance and minor repairs. However, additional tools such as a torque wrench may be necessary to perform certain maintenance work correctly.

# PERIODIC MAINTENANCE AND MINOR REPAIR

---

---

**NOTE:** \_\_\_\_\_

If you do not have the tools or experience required for a particular job, have a Yamaha dealer perform it for you.

---

EWA10350

 **WARNING**

**Modifications not approved by Yamaha may cause loss of performance and render the vehicle unsafe for use. Consult a Yamaha dealer before attempting any changes.**

---

# PERIODIC MAINTENANCE AND MINOR REPAIR

EAU17715

## Periodic maintenance and lubrication chart

### NOTE:

- The annual checks must be performed every year, except if a kilometer-based maintenance, or for the UK, a mileage-based maintenance, is performed instead.
- From 30000 km (17500 mi), repeat the maintenance intervals starting from 6000 km (3500 mi).
- Items marked with an asterisk should be performed by a Yamaha dealer as they require special tools, data and technical skills.

| NO. | ITEM                           | CHECK OR MAINTENANCE JOB  | ODOMETER READING           |                      |                       |                        |                        | ANNUAL CHECK |
|-----|--------------------------------|---|----------------------------|----------------------|-----------------------|------------------------|------------------------|--------------|
|     |                                |   | 1000 km<br>(600 mi)        | 6000 km<br>(3500 mi) | 12000 km<br>(7000 mi) | 18000 km<br>(10500 mi) | 24000 km<br>(14000 mi) |              |
| 1   | * Fuel line                    | <ul style="list-style-type: none"> <li>• Check fuel hoses for cracks or damage.</li> </ul>                      |                            | √                    | √                     | √                      | √                      | √            |
| 2   | Spark plug                     | <ul style="list-style-type: none"> <li>• Check condition.</li> <li>• Clean and regap.</li> </ul>                |                            | √                    |                       | √                      |                        |              |
|     |                                | <ul style="list-style-type: none"> <li>• Replace.</li> </ul>  |                            |                      | √                     |                        | √                      |              |
| 3   | * Valves                       | <ul style="list-style-type: none"> <li>• Check valve clearance.</li> <li>• Adjust.</li> </ul>                   |                            | √                    | √                     | √                      | √                      |              |
| 4   | Air filter element             | <ul style="list-style-type: none"> <li>• Replace.</li> </ul>  |                            |                      | √                     |                        | √                      |              |
| 5   | V-belt case air filter element | <ul style="list-style-type: none"> <li>• Clean.</li> </ul>  |                            | √                    | √                     | √                      | √                      |              |
| 6   | * Front brake                  | <ul style="list-style-type: none"> <li>• Check operation, fluid level and vehicle for fluid leakage.</li> </ul> | √                          | √                    | √                     | √                      | √                      | √            |
|     |                                | <ul style="list-style-type: none"> <li>• Replace brake pads.</li> </ul>   | Whenever worn to the limit |                      |                       |                        |                        |              |

# PERIODIC MAINTENANCE AND MINOR REPAIR

| NO.  | ITEM                      | CHECK OR MAINTENANCE JOB   | ODOMETER READING           |                      |                       |                        |                        | ANNUAL CHECK |
|------|---------------------------|--|----------------------------|----------------------|-----------------------|------------------------|------------------------|--------------|
|      |                           |  | 1000 km<br>(600 mi)        | 6000 km<br>(3500 mi) | 12000 km<br>(7000 mi) | 18000 km<br>(10500 mi) | 24000 km<br>(14000 mi) |              |
| 7 *  | Rear brake                | • Check operation, fluid level and vehicle for fluid leakage.  | √                          | √                    | √                     | √                      | √                      | √            |
|      |                           | • Replace brake pads.  | Whenever worn to the limit |                      |                       |                        |                        |              |
| 8 *  | Brake hose                | • Check for cracks or damage.  |                            | √                    | √                     | √                      | √                      | √            |
|      |                           | • Replace.   | Every 4 years              |                      |                       |                        |                        |              |
| 9 *  | Wheels                    | • Check runout and for damage.   |                            | √                    | √                     | √                      | √                      |              |
| 10 * | Tires                     | • Check tread depth and for damage.<br>• Replace if necessary.<br>• Check air pressure.<br>• Correct if necessary. |                            | √                    | √                     | √                      | √                      | √            |
| 11 * | Wheel bearings            | • Check bearing for looseness or damage.   |                            | √                    | √                     | √                      | √                      |              |
| 12 * | Steering bearings         | • Check bearing play and steering for roughness.   | √                          | √                    | √                     | √                      | √                      |              |
|      |                           | • Lubricate with lithium-soap-based grease.  | Every 24000 km (14000 mi)  |                      |                       |                        |                        |              |
| 13 * | Chassis fasteners         | • Make sure that all nuts, bolts and screws are properly tightened.  |                            | √                    | √                     | √                      | √                      | √            |
| 14   | Sidestand, centerstand    | • Check operation.<br>• Lubricate.   |                            | √                    | √                     | √                      | √                      | √            |
| 15 * | Sidestand switch          | • Check operation.   | √                          | √                    | √                     | √                      | √                      | √            |
| 16 * | Front fork                | • Check operation and for oil leakage.   |                            | √                    | √                     | √                      | √                      |              |
| 17 * | Shock absorber assemblies | • Check operation and shock absorbers for oil leakage.   |                            | √                    | √                     | √                      | √                      |              |
| 18 * | Cooling system            | • Check coolant level and vehicle for coolant leakage.   |                            | √                    | √                     | √                      | √                      | √            |
|      |                           | • Change.  | Every 3 years              |                      |                       |                        |                        |              |
| 19 * | Fuel injection            | • Check engine idle speed.   | √                          | √                    | √                     | √                      | √                      | √            |

# PERIODIC MAINTENANCE AND MINOR REPAIR

| NO. | ITEM                              | CHECK OR MAINTENANCE JOB  | ODOMETER READING          |  |                       |                        |                        | ANNUAL CHECK |
|-----|-----------------------------------|---|---------------------------|--|-----------------------|------------------------|------------------------|--------------|
|     |                                   |   | 1000 km<br>(600 mi)       | 6000 km<br>(3500 mi)   | 12000 km<br>(7000 mi) | 18000 km<br>(10500 mi) | 24000 km<br>(14000 mi) |              |
| 20  | Engine oil                        | • Change. (See pages 6-10)  | √                         | When the oil change indicator light comes on (5000 km (2920 mi) after the initial 1000 km (600 mi) and every 6000 km (3500 mi) thereafter) |                       |                        |                        |              |
|     |                                   | • Check oil level and vehicle for oil leakage.  |                           | Every 3000 km (1800 mi)  |                       |                        |                        | √            |
| 21  | Engine oil filter element         | • Replace.  | √                         |  | √                     |                        | √                      |              |
| 22  | Final transmission oil            | • Check vehicle for oil leakage.  | √                         | √  |                       | √                      |                        |              |
|     |                                   | • Change.   | √                         |  | √                     |                        | √                      |              |
| 23  | * V-belt                          | • Replace.  | Every 18000 km (10500 mi) |  |                       |                        |                        |              |
| 24  | * Front and rear brake switches   | • Check operation.  | √                         | √  | √                     | √                      | √                      | √            |
| 25  | Moving parts and cables           | • Lubricate.  |                           | √  | √                     | √                      | √                      | √            |
| 26  | * Throttle grip housing and cable | • Check operation and free play.<br>• Adjust the throttle cable free play if necessary.<br>• Lubricate the throttle grip housing and cable. |                           | √  | √                     | √                      | √                      | √            |
| 27  | * Lights, signals and switches    | • Check operation.<br>• Adjust headlight beam.  | √                         | √  | √                     | √                      | √                      | √            |

# PERIODIC MAINTENANCE AND MINOR REPAIR

---

---

EAU18670

## NOTE:

---

- The air filter needs more frequent service if you are riding in unusually wet or dusty areas.
  - Hydraulic brake service
    - Regularly check and, if necessary, correct the brake fluid level.
    - Every two years replace the internal components of the brake master cylinders and calipers, and change the brake fluid.
    - Replace the brake hoses every four years and if cracked or damaged.
-

# PERIODIC MAINTENANCE AND MINOR REPAIR

## Removing and installing the cowlings and panel

EAU18731

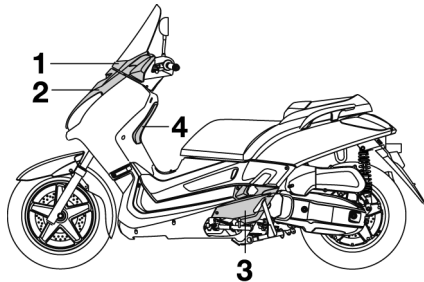

1. Cowling A
2. Cowling B
3. Cowling C
4. Panel A

6

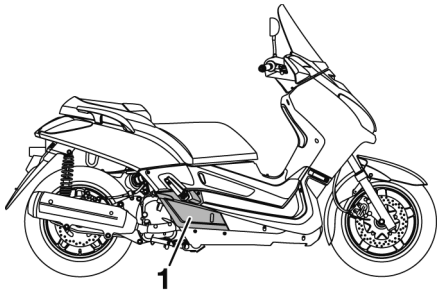

1. Cowling D

The cowlings and panel shown need to be removed to perform some of the maintenance jobs described in this chapter. Refer to this section each time a cowling or panel needs to be removed and installed.

### Cowling A

EAU18900

#### To remove the cowling

1. Remove the cowling bolts.

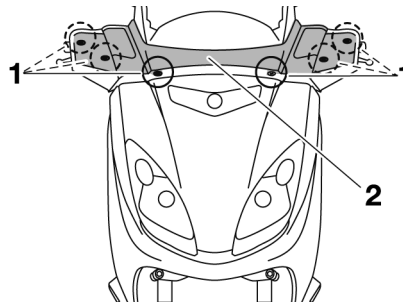

1. Screw
2. Cowling A

2. Disconnect the turn signal light lead connectors, and then take the cowling off.

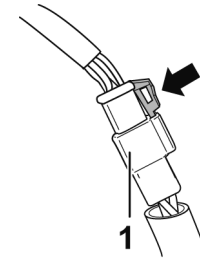

1. Turn signal light lead coupler

#### To install the cowling

1. Connect the turn signal light lead connectors.
2. Place the cowling in the original position.
3. Install the cowling bolts.



# PERIODIC MAINTENANCE AND MINOR REPAIR

EAU18790

## Cowling B

### To remove the cowling

Remove the screws, and then take the cowling off.

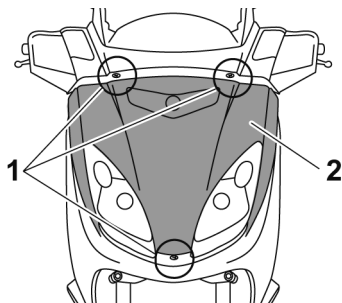

1. Screw
2. Cowling B

### To install the cowling

Place the cowling in the original position, and then install the screws.

EAU18790

## Cowling C

### To remove the cowling

Remove the screws, and then take the cowling off.

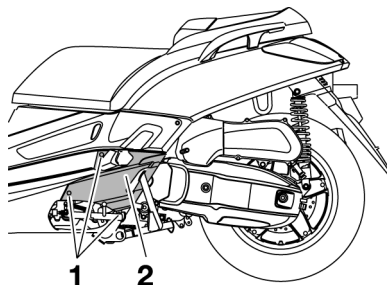

1. Screw
2. Cowling C

### To install the cowling

Place the cowling in the original position, and then install the screws.

EAU18790

## Cowling D

### To remove the cowling

Remove the screws, and then take the cowling off.

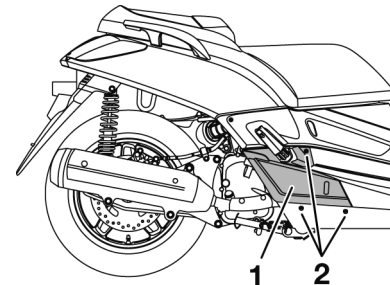

1. Cowling D
2. Screw

### To install the cowling

Place the cowling in the original position, and then install the screws.

# PERIODIC MAINTENANCE AND MINOR REPAIR

EAU1250

## Panel A

### To remove the panel

1. Open the storage compartment.  
(See page 3-15.)

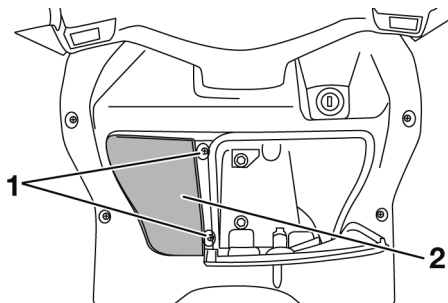

1. Screw
2. Panel A

2. Remove the screw, and then take the panel off.

### To install the panel

1. Place the panel in the original position, and then install the screw.
2. Close the storage compartment.

EAU19631

## Checking the spark plug

The spark plug is an important engine component, which is easy to check. Since heat and deposits will cause any spark plug to slowly erode, the spark plug should be removed and checked in accordance with the periodic maintenance and lubrication chart. In addition, the condition of the spark plug can reveal the condition of the engine.

### To remove the spark plug

1. Remove cowling D. (See page 6-7.)
2. Remove the spark plug cap.

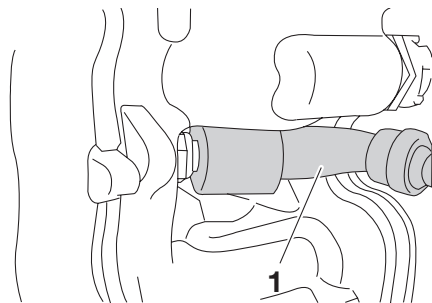

1. Spark plug cap

3. Remove the spark plug as shown, with the spark plug wrench included in the owner's tool kit.

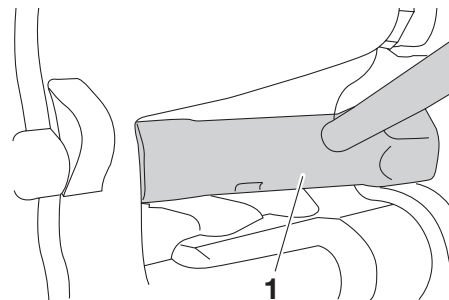

1. Spark plug wrench

### To check the spark plug

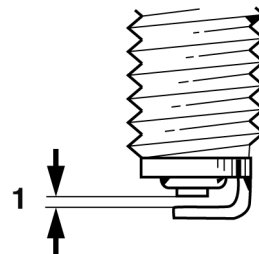

ZAJM0037

1. Spark plug gap

# PERIODIC MAINTENANCE AND MINOR REPAIR

EAM2270

1. Check that the porcelain insulator around the center electrode of the spark plug is a medium-to-light tan (the ideal color when the vehicle is ridden normally).

## NOTE:

If the spark plug shows a distinctly different color, the engine could be operating improperly. Do not attempt to diagnose such problems yourself. Instead, have a Yamaha dealer check the vehicle.

2. Check the spark plug for electrode erosion and excessive carbon or other deposits, and replace it if necessary.

**Specified spark plug:**  
NGK/ CPR 9EA-9

## To install the spark plug

1. Measure the spark plug gap with a wire thickness gauge and, if necessary, adjust the gap to specification.

### Spark plug gap:

0.8-0.9 mm (0.031-0.035 in)

2. Clean the surface of the spark plug gasket and its mating surface, and then wipe off any grime from the spark plug threads.
3. Install the spark plug with the spark plug wrench, and then tighten it to the specified torque.

### Tightening torque:

Spark plug:  
12.5 Nm (1.25 m·kgf, 9.0 ft·lbf)

## NOTE:

If a torque wrench is not available when installing a spark plug, a good estimate of the correct torque is 1/4 ~ 1/2 turn past finger tight. However, the spark plug should be tightened to the specified torque as soon as possible.

4. Install the spark plug cap.
5. Install the cowl.

## Engine oil

The engine oil level should be checked before each ride. In addition, the oil must be changed at the intervals specified in the periodic maintenance and lubrication chart and when the service indicator light comes on.

### To check the engine oil level

1. Place the scooter on the centerstand.

## NOTE:

Make sure that the scooter is positioned straight up when checking the oil level. A slight tilt to the side can result in a false reading.

2. Start the engine, warm it up for several minutes, and then turn it off.

# PERIODIC MAINTENANCE AND MINOR REPAIR

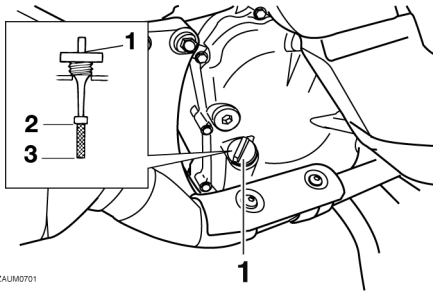

ZAJM0701

1. Engine oil filler cap
2. Maximum level mark
3. Minimum level mark

3. Wait a few minutes until the oil settles, remove the oil filler cap, wipe the dipstick clean, insert it back into the oil filler hole (without screwing it in), and then remove it again to check the oil level.

## NOTE:

The engine oil should be between the minimum and maximum level marks.

4. If the engine oil is below the minimum level mark, add sufficient oil of the recommended type to raise it to the correct level.

5. Insert the dipstick into the oil filler hole, and then tighten the oil filler cap.

## To change the engine oil (with or without oil filter element replacement)

1. Start the engine, warm it up for several minutes, and then turn it off.
2. Place an oil pan under the engine to collect the used oil.
3. Remove the engine oil filler cap and the engine oil drain bolt to drain the oil from the crankcase.

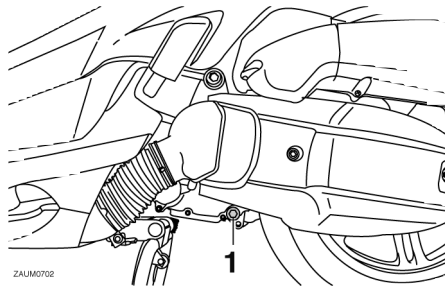

ZAJM0702

1. Engine oil drain bolt

4. Check the drain bolt washer for damage and replace it if necessary.

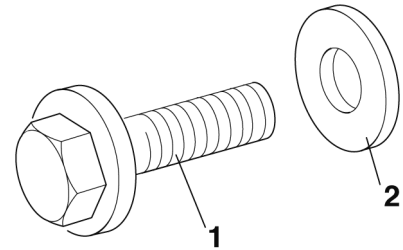

ZAJM0129

1. Engine oil drain bolt
2. Washer

## NOTE:

Skip steps 5 to 9 if the oil filter element is not being replaced.

5. Remove the oil filter element cover by removing the bolts.

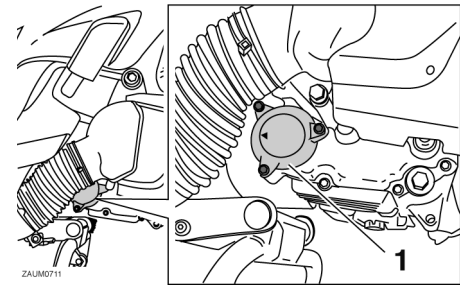

ZAJM0711

1. Oil filter element cover

# PERIODIC MAINTENANCE AND MINOR REPAIR

6. Remove the oil filter element and o-ring.

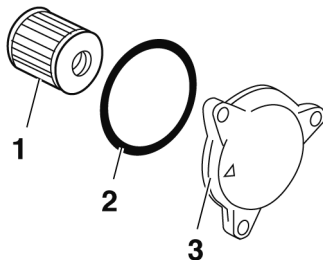

ZAJUM0712

1. Oil filter element  
2. O-ring  
3. Oil filter element cover

7. Check the O-ring for damage and replace it if necessary.  
8. Install the new oil filter element and an O-ring.  
9. Install the oil filter element cover by installing the bolts, then tightening them to the specified torque.

### Tightening torque:

Oil filter cover bolt:  
10 Nm (1.0 m·kgf, 7.2 ft·lbf)

**NOTE:** \_\_\_\_\_  
Make sure that the O-ring is properly seated.

10. Install the washer and the engine oil drain bolt, and then tighten the drain bolt to the specified torque.

### Tightening torque:

Engine oil drain bolt:  
32 Nm (3.2 m·kgf, 23 ft·lbf)

**NOTE:** \_\_\_\_\_  
Make sure that the washer is properly seated.

11. Add the specified amount of the recommended engine oil, and then install and tighten the oil filler cap.

### Recommended engine oil:

See page 8-1.

### Oil change quantity:

Without oil filter element replacement

1.40 L (1.48 US qt) (1.23 Imp.qt)

With oil filter element replacement

1.50 L (1.59 US qt) (1.32 Imp.qt)

**NOTE:** \_\_\_\_\_  
Be sure to wipe off spilled oil on any parts after the engine and exhaust system have cooled down.

ECA11670

### CAUTION:

- Do not use oils with a diesel specification of “CD” or oils of a higher quality than specified. In addition, do not use oils labeled “ENERGY CONSERVING II” or higher.
- Be sure no foreign material enters the crankcase.

12. Start the engine, and then let it idle for several minutes while checking it for oil leakage. If oil is leaking, immediately turn the engine off and check for the cause.
13. Turn the engine off, and then check the oil level and correct it if necessary.
14. Reset the oil change indicator. (See page 3-6.)

# PERIODIC MAINTENANCE AND MINOR REPAIR

EAU20061

## Final transmission oil

The final transmission case must be checked for oil leakage before each ride. If any leakage is found, have a Yamaha dealer check and repair the scooter. In addition, the final transmission oil must be changed as follows at the intervals specified in the periodic maintenance and lubrication chart.

1. Start the engine, warm up the final transmission oil by riding the scooter for several minutes, and then stop the engine.
2. Place the scooter on the centerstand.
3. Place an oil pan under the final transmission case to collect the used oil.
4. Remove the oil filler cap and drain bolt to drain the oil from the final transmission case.

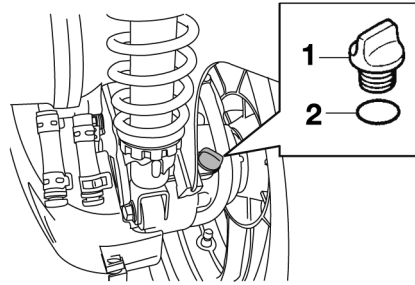

1. Final transmission oil filler cap
2. O-ring

5. Install the final transmission oil drain bolt, and then tighten it to the specified torque.

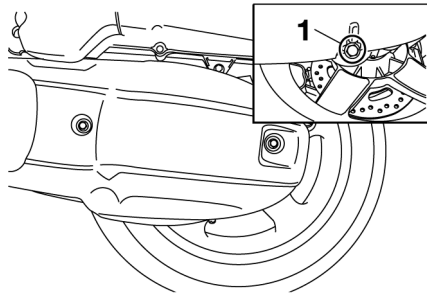

1. Final transmission oil drain bolt

### Tightening torque:

Final transmission oil drain bolt:  
20 Nm (2.0 m·kgf, 14 ft·lbf)

6. Add the specified amount of the recommended final transmission oil, and then install and tighten the oil filler cap.

### Recommended final transmission oil:

See page 8-1.

### Oil quantity:

0.21 L (0.22 US qt) (0.18 Imp.qt)

EWA11310

### **WARNING**

- Make sure that no foreign material enters the final transmission case.
- Make sure that no oil gets on the tire or wheel.

7. Check the final transmission case for oil leakage. If oil is leaking, check for the cause.

# PERIODIC MAINTENANCE AND MINOR REPAIR

EAU20070

## Coolant

The coolant level should be checked before each ride. In addition, the coolant must be changed at the intervals specified in the periodic maintenance and lubrication chart.

EAUS1273

### To check the coolant level

1. Place the vehicle on a level surface and hold it in an upright position.

### NOTE:

- The coolant level must be checked on a cold engine since the level varies with engine temperature.
  - Make sure that the vehicle is positioned straight up when checking the coolant level. A slight tilt to the side can result in a false reading.
2. Check the coolant level through the check window.

### NOTE:

The coolant should be between the minimum and maximum level marks.

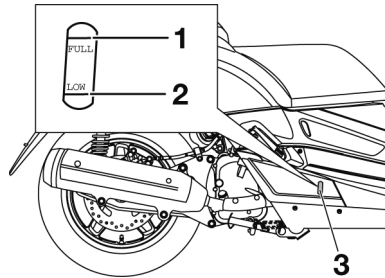

1. Maximum level mark
2. Minimum level mark
3. Coolant level window

3. If the coolant is at or below the minimum level mark, remove the right floorboard mat by pulling it up.
4. Open the reservoir cap, and then add coolant to the maximum level mark.

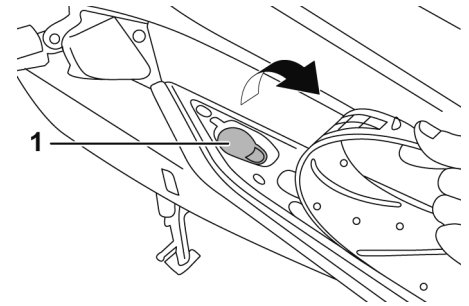

1. Coolant reservoir cap

### Coolant reservoir capacity:

0.26 L (0.27 US qt) (0.23 Imp.qt)

ECA10471

### CAUTION:

- If coolant is not available, use distilled water or soft tap water instead. Do not use hard water or salt water since it is harmful to the engine.
- If water has been used instead of coolant, replace it with coolant as soon as possible, otherwise the cooling system will not be protected against frost and corrosion.

# PERIODIC MAINTENANCE AND MINOR REPAIR

- If water has been added to the coolant, have a Yamaha dealer check the antifreeze content of the coolant as soon as possible, otherwise the effectiveness of the coolant will be reduced.

EWA10380

## **⚠ WARNING**

**Never attempt to remove the radiator cap when the engine is hot.**

5. Close the reservoir cap
6. Place the floorboard mat in the original position and push it downward to secure it.

EAU33030

## Changing the coolant

EWA10380

## **⚠ WARNING**

**Never attempt to remove the radiator cap when the engine is hot.**

The coolant must be changed at the intervals specified in the periodic maintenance and lubrication chart. Have a Yamaha dealer change the coolant.

EAUM2241

## Air filter and V-belt case air filter elements

The air filter element should be replaced and the V-belt case air filter element should be cleaned at the intervals specified in the periodic maintenance and lubrication chart. Service the air filter elements more frequently if you are riding in unusually wet or dusty areas.

### Replacing the air filter element

1. Place the scooter on the centerstand.
2. Remove the air filter case cover by removing the screws.

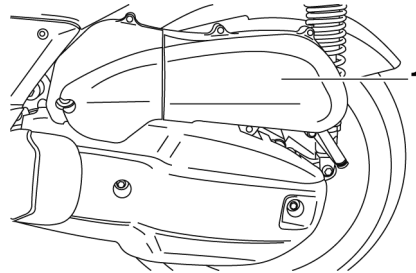

1. Air filter case cover

3. Pull the air filter element out.

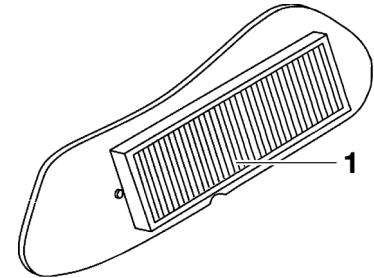

1. Air filter element

4. Insert a new air filter element into the air filter case.
5. Install the air filter case cover by installing the screws.

### Cleaning the V-belt case air filter element

1. Remove the V-belt case air filter covers by removing the screws.



# PERIODIC MAINTENANCE AND MINOR REPAIR

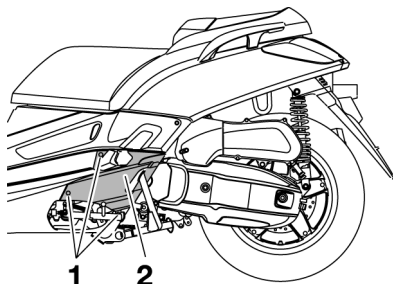

1. Screw
2. Cowling C

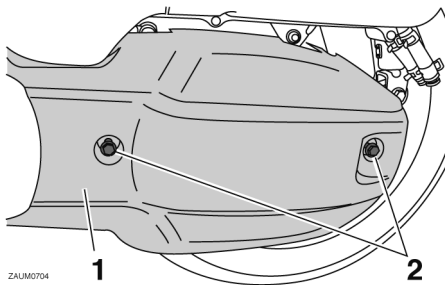

1. V-belt case air filter cover
2. Screw

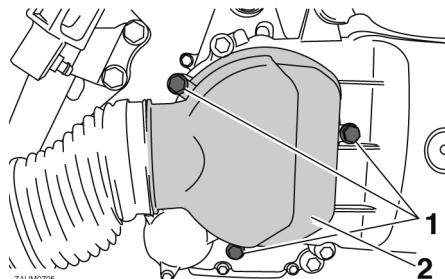

1. Screw
2. V-belt case air filter cover

2. Remove the air filter element, and then blow out the dirt with compressed air as shown.

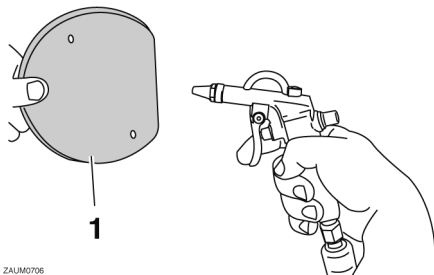

1. V-belt case air filter element

3. Check the air filter element for damage and replace it if necessary.
4. Install the air filter element with the colored side facing outward.
5. Install the V-belt case air filter covers by installing the screws.

ECA10530

## CAUTION:

- Make sure that each filter element is properly seated in its case.
- The engine should never be operated without the filter elements installed, otherwise the piston(s) and/or cylinder(s) may become excessively worn.

# PERIODIC MAINTENANCE AND MINOR REPAIR

EAUS1290

## Adjusting the throttle cable free play

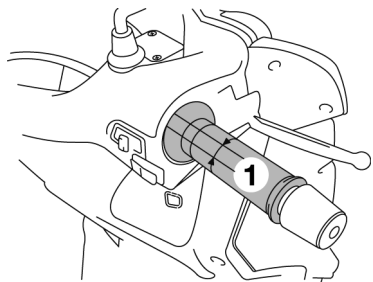

1. Throttle cable free play

6

The throttle cable free play should measure 3.0 -5.0 mm (0.12 -0.20 in) at the throttle grip. Periodically check the throttle cable free play and, if necessary, adjust it as follows.

### NOTE:

The engine idling speed must be correctly adjusted before checking and adjusting the throttle cable free play.

1. Remove cowling A (See page 6-7).
2. Loosen the locknut.

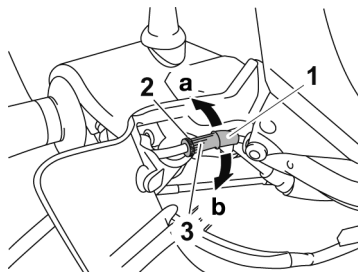

1. Rubber cap
2. Locknut
3. Adjusting nut

3. To increase the throttle cable free play, turn the adjusting nut in direction (a). To decrease the throttle cable free play, turn the adjusting nut in direction (b).
4. Tighten the locknut.
5. Install the cowling.

EAU21401

## Valve clearance

The valve clearance changes with use, resulting in improper air-fuel mixture and/or engine noise. To prevent this from occurring, the valve clearance must be adjusted by a Yamaha dealer at the intervals specified in the periodic maintenance and lubrication chart.

# PERIODIC MAINTENANCE AND MINOR REPAIR

EAU21871

## Tires

To maximize the performance, durability, and safe operation of your scooter, note the following points regarding the specified tires.

### Tire air pressure

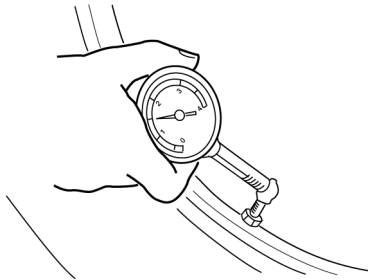

ZALUM0053

The tire air pressure should be checked and, if necessary, adjusted before each ride.

EWA10500

### **⚠ WARNING**

- The tire air pressure must be checked and adjusted on cold tires (i.e., when the temperature of the tires equals the ambient temperature).

- The tire air pressure must be adjusted in accordance with the riding speed and with the total weight of rider, passenger, cargo, and accessories approved for this model.

#### Tire air pressure (measured on cold tires):

Up to 90 kg (198 lb):

Front:

190 kPa (28 psi) (1.90 kgf/cm<sup>2</sup>)

Rear:

220 kPa (32 psi) (2.20 kgf/cm<sup>2</sup>)

90 kg (198 lb) to maximum load:

Front:

210 kPa (30 psi) (2.10 kgf/cm<sup>2</sup>)

Rear:

250 kPa (36 psi) (2.50 kgf/cm<sup>2</sup>)

#### Maximum load\*:

189 kg (417 lb)

\* Total weight of rider, passenger, cargo and accessories

EWA14660

### **⚠ WARNING**

Because loading has an enormous impact on the handling, braking, performance and safety characteristics of your vehicle, you should

keep the following precautions in mind.

- **NEVER OVERLOAD THE VEHICLE!** Operation of an overloaded vehicle may result in tire damage, loss of control, or severe injury. Make sure that the total weight of rider, passenger, cargo, and accessories does not exceed the specified maximum load for the vehicle.
- Do not carry along loosely packed items, which can shift during a ride.
- Securely pack the heaviest items close to the center of the vehicle and distribute the weight evenly on both sides.
- Adjust the suspension and tire air pressure with regard to the load.
- Check the tire condition and air pressure before each ride.

# PERIODIC MAINTENANCE AND MINOR REPAIR

## Tire inspection

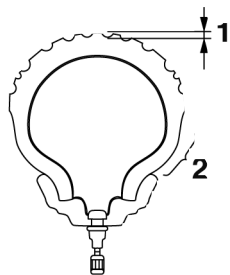

ZAUM0054

1. Tire tread depth
2. Tire sidewall

The tires must be checked before each ride. If the center tread depth reaches the specified limit, if the tire has a nail or glass fragments in it, or if the sidewall is cracked, have a Yamaha dealer replace the tire immediately.

### Minimum tire tread depth (front and rear):

1.6 mm (0.06 in)

## NOTE:

The tire tread depth limits may differ from country to country. Always comply with the local regulations.

## Tire information

This scooter is equipped with tubeless tires.

### Front tire:

#### Size:

120/70-15 M/C 56S(Michelin - Continental)

120/70-15 M/C 56P(Pirelli)

#### Manufacturer/model:

Michelin/GoldStandard

Continental/ContiTwist TL

Pirelli/GTS23

### Rear tire:

#### Size:

140/70-14 M/C 68S(Michelin - Continental)

140/70-14 M/C 68P(Pirelli)

#### Manufacturer/model:

Michelin/GoldStandard

Continental/ContiTwist TL

Pirelli/GTS24

## WARNING

EWA10470

- Have a Yamaha dealer replace excessively worn tires. Besides being illegal, operating the vehicle with excessively worn tires decreases riding stability and can lead to loss of control.
- The replacement of all wheel and brake related parts, including the tires, should be left to a Yamaha dealer, who has the necessary professional knowledge and experience.

# PERIODIC MAINTENANCE AND MINOR REPAIR

EAU21960

## Cast wheels

To maximize the performance, durability, and safe operation of your vehicle, note the following points regarding the specified wheels.

- The wheel rims should be checked for cracks, bends or warpage before each ride. If any damage is found, have a Yamaha dealer replace the wheel. Do not attempt even the smallest repair to the wheel. A deformed or cracked wheel must be replaced.
- The wheel should be balanced whenever either the tire or wheel has been changed or replaced. An unbalanced wheel can result in poor performance, adverse handling characteristics, and a shortened tire life.
- Ride at moderate speeds after changing a tire since the tire surface must first be “broken in” for it to develop its optimal characteristics.

EAU33453

## Front and rear brake lever free play

### Front

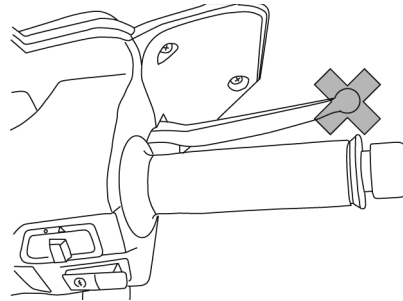

There should be no free play at the brake lever ends. If there is free play, have a Yamaha dealer inspect the brake system.

EWA14211

### **⚠ WARNING**

**A soft or spongy feeling in the brake lever can indicate the presence of air in the hydraulic system. If there is air in the hydraulic system, have a Yamaha dealer bleed the system before operating the vehicle. Air in the hydraulic system will diminish the braking performance, which may result in loss of control and an accident.**

### Rear

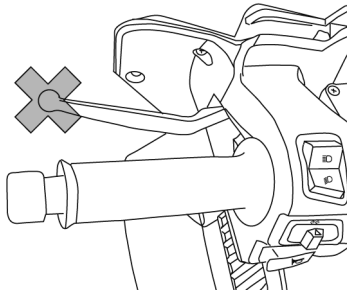

# PERIODIC MAINTENANCE AND MINOR REPAIR

EAU22390

## Checking the front and rear brake pads

The front and rear brake pads must be checked for wear at the intervals specified in the periodic maintenance and lubrication chart.

EAU22400

### Front brake pads

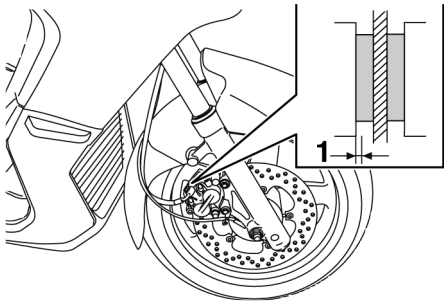

1. Lining thickness

Check each front brake pad for damage and measure the lining thickness. If a brake pad is damaged or if the lining thickness is less than 0.5 mm (0.02 in), have a Yamaha dealer replace the brake pads as a set.

EAU22520

### Rear brake pads

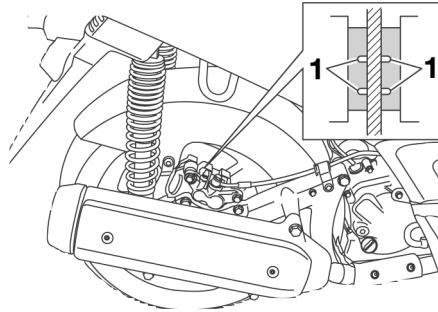

1. Brake pad wear indicator groove

The rear brake is provided with a check plug, which, if it is removed, allows you to check the brake pad wear without disassembling the brake. To check the brake pad wear, check the position of the wear indicator while applying the brake. If a brake pad has worn to the point that the wear indicator almost touches the brake disc, have a Yamaha dealer replace the brake pads as a set.

EAU22580

## Checking the brake fluid level

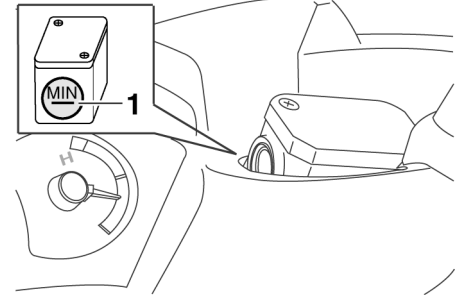

1. Minimum level mark

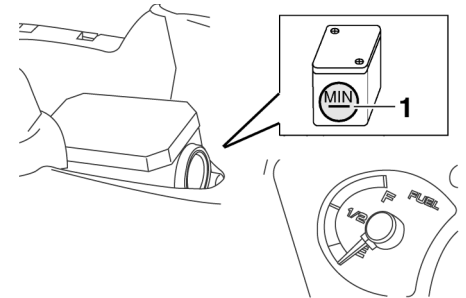

1. Minimum level mark

Insufficient brake fluid may allow air to enter the brake system, possibly causing it to become ineffective.

# PERIODIC MAINTENANCE AND MINOR REPAIR

EAU22720

Before riding, check that the brake fluid is above the minimum level mark and replenish if necessary. A low brake fluid level may indicate worn brake pads and/or brake system leakage. If the brake fluid level is low, be sure to check the brake pads for wear and the brake system for leakage.

Observe these precautions:

- When checking the fluid level, make sure that the top of the brake fluid reservoir is level.
- Use only the recommended quality brake fluid, otherwise the rubber seals may deteriorate, causing leakage and poor braking performance.

**Recommended brake fluid:**  
DOT 4

- Refill with the same type of brake fluid. Mixing fluids may result in a harmful chemical reaction and lead to poor braking performance.
- Be careful that water does not enter the brake fluid reservoir

when refilling. Water will significantly lower the boiling point of the fluid and may result in vapor lock.

- Brake fluid may deteriorate painted surfaces or plastic parts. Always clean up spilled fluid immediately.
- As the brake pads wear, it is normal for the brake fluid level to gradually go down. However, if the brake fluid level goes down suddenly, have a Yamaha dealer check the cause.

## Changing the brake fluid

Have a Yamaha dealer change the brake fluid at the intervals specified in the NOTE after the periodic maintenance and lubrication chart. In addition, have the oil seals of the brake master cylinder and caliper as well as the brake hose replaced at the intervals listed below or whenever they are damaged or leaking.

- Oil seals: Replace every two years.
- Brake hose: Replace every four years.

# PERIODIC MAINTENANCE AND MINOR REPAIR

EAU23100

## Checking and lubricating the cables

The operation of all control cables and the condition of the cables should be checked before each ride, and the cables and cable ends should be lubricated if necessary. If a cable is damaged or does not move smoothly, have a Yamaha dealer check or replace it.

**Recommended lubricant:**  
Engine oil

6

### **⚠ WARNING**

**Damage to the outer sheath may interfere with proper cable operation and will cause the inner cable to rust. Replace a damaged cable as soon as possible to prevent unsafe conditions.**

EWA10720

EAU23111

## Checking and lubricating the throttle grip and cable

The operation of the throttle grip should be checked before each ride. In addition, the cable should be lubricated at the intervals specified in the periodic maintenance chart.

EAU23171

## Lubricating the front and rear brake levers

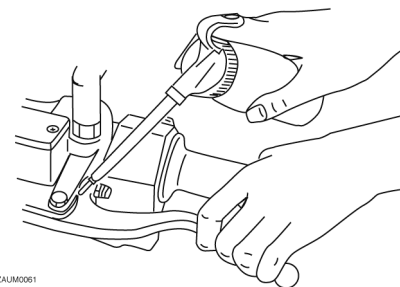

ZAJM0051

The pivoting points of the front and rear brake levers must be lubricated at the intervals specified in the periodic maintenance and lubrication chart.

**Recommended lubricant:**  
Lithium-soap-based grease (all-purpose grease)



# PERIODIC MAINTENANCE AND MINOR REPAIR

## Checking and lubricating the centerstand and sidestand

EAU23212

to-metal contact surfaces should be lubricated if necessary.

EWA10740

### **⚠ WARNING**

If the centerstand or sidestand does not move up and down smoothly, have a Yamaha dealer check or repair it.

**Recommended lubricant:**  
Lithium-soap-based grease

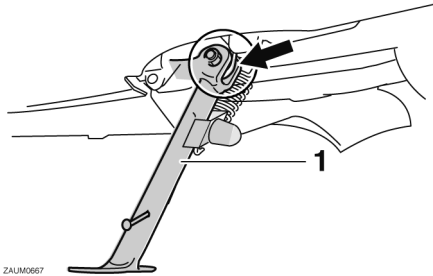

1. Sidestand

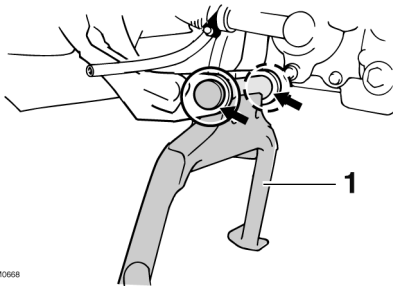

1. Centerstand

The operation of the centerstand and sidestand should be checked before each ride, and the pivots and metal-

## Checking the front fork

EAU23271

The condition and operation of the front fork must be checked as follows at the intervals specified in the periodic maintenance and lubrication chart.

To check the condition

EWA10750

### **⚠ WARNING**

Securely support the vehicle so that there is no danger of it falling over.

Check the inner tubes for scratches, damage and excessive oil leakage.

To check the operation

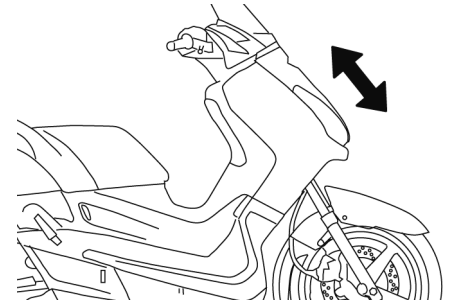

1. Place the vehicle on a level surface and hold it in an upright position.

# PERIODIC MAINTENANCE AND MINOR REPAIR

2. While applying the front brake, push down hard on the handlebars several times to check if the front fork compresses and rebounds smoothly.

ECA10590

## CAUTION:

**If any damage is found or the front fork does not operate smoothly, have a Yamaha dealer check or repair it.**

EAU23280

## Checking the steering

Worn or loose steering bearings may cause danger. Therefore, the operation of the steering must be checked as follows at the intervals specified in the periodic maintenance and lubrication chart.

1. Place a stand under the engine to raise the front wheel off the ground.

EWA10750

## WARNING

**Securely support the vehicle so that there is no danger of it falling over.**

2. Hold the lower ends of the front fork legs and try to move them forward and backward. If any free play can be felt, have a Yamaha dealer check or repair the steering.

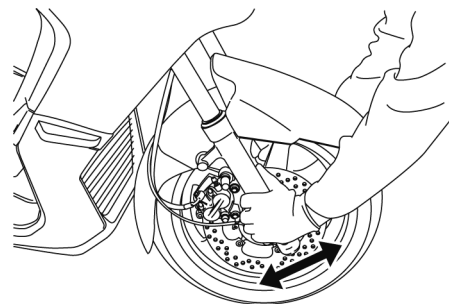

# PERIODIC MAINTENANCE AND MINOR REPAIR

EAU23290

## Checking the wheel bearings

The front and rear wheel bearings must be checked at the intervals specified in the periodic maintenance and lubrication chart. If there is play in the wheel hub or if the wheel does not turn smoothly, have a Yamaha dealer check the wheel bearings.

EAUT1401

## Battery

This model is equipped with a sealed-type (MF) battery, which does not require any maintenance. There is no need to check the electrolyte or to add distilled water.

ECA10630

### CAUTION:

- Always keep the battery charged. Storing a discharged battery can cause permanent battery damage.
- To charge a sealed-type (MF) battery, a special (constant-voltage) battery charger is required. Using a conventional battery charger will damage the battery. If you do not have access to a sealed-type (MF) battery charger, have a Yamaha dealer charge your battery.

EWA10760

### WARNING

- Electrolyte is poisonous and dangerous since it contains sulfuric acid, which causes severe burns. Avoid any con-

tact with skin, eyes or clothing and always shield your eyes when working near batteries. In case of contact, administer the following FIRST AID.

- **EXTERNAL:** Flush with plenty of water.
- **INTERNAL:** Drink large quantities of water or milk and immediately call a physician.
- **EYES:** Flush with water for 15 minutes and seek prompt medical attention.
- Batteries produce explosive hydrogen gas. Therefore, keep sparks, flames, cigarettes, etc., away from the battery and provide sufficient ventilation when charging it in an enclosed space.
- **KEEP THIS AND ALL BATTERIES OUT OF THE REACH OF CHILDREN.**

### To charge the battery

Have a Yamaha dealer charge the battery as soon as possible if it seems to have discharged. Keep in mind that the battery tends to discharge more

# PERIODIC MAINTENANCE AND MINOR REPAIR

quickly if the vehicle is equipped with optional electrical accessories.

## To store the battery

1. If the vehicle will not be used for more than one month, remove the battery, fully charge it, and then place it in a cool, dry place.
2. If the battery will be stored for more than two months, check it at least once a month and fully charge it if necessary.

## To remove the battery

1. Remove the panel by removing the screw.
2. Remove the battery holder bracket by removing the bolt.

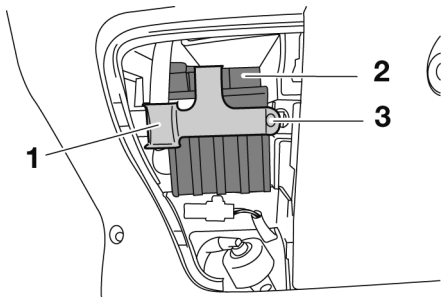

1. Battery support
2. Battery
3. Screw

3. Pull the battery out from the battery box, and then disconnect the battery couplers.

## To install the battery

1. Connect the battery couplers, and then place the battery in the original position.
2. Install the battery holder bracket by installing the bolt.
3. Install the panel by installing the screw.
4. Fully charge the battery before installation.

EAU23525

## Replacing the fuses

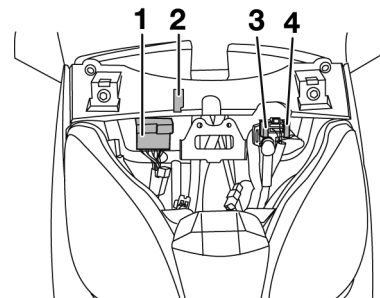

1. Fuse box
2. Fuse box cover
3. Main fuse
4. Spare main fuse

The main fuse and the fuse box, which contains the fuses for the individual circuits, are located behind cowling B. (See page 6-7.)

# PERIODIC MAINTENANCE AND MINOR REPAIR

ECA10640

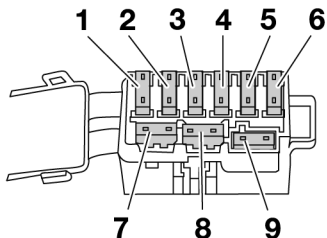

1. Signaling system fuse
2. Headlight fuse
3. Radiator fan fuse
4. Ecu fuse (backup)
5. Ignition fuse
6. Backup fuse (backup)
7. Spare fuse
8. Spare fuse
9. Spare fuse

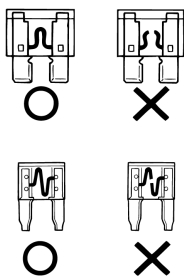

If a fuse is blown, replace it as follows.

1. Turn the key to “OFF” and turn off the electrical circuit in question.
2. Remove the blown fuse, and then install a new fuse of the specified amperage.

## Specified fuses:

- Main fuse:  
30.0 A
- Headlight fuse:  
15.0 A
- Signaling system fuse:  
15.0 A
- Ignition fuse:  
10.0 A
- Radiator fan fuse:  
10.0 A
- ECU (Electronic Control Unit) fuse:  
5.0 A
- Backup fuse:  
5.0 A
- Main spare fuse:  
30.0 A
- Spare fuse:  
15.0 A
- Spare fuse:  
10.0 A
- Spare fuse:  
5.0 A

## CAUTION:

**Do not use a fuse of a higher amperage rating than recommended to avoid causing extensive damage to the electrical system and possibly a fire.**

3. Turn the key to “ON” and turn on the electrical circuit in question to check if the device operates.
4. If the fuse immediately blows again, have a Yamaha dealer check the electrical system.

# PERIODIC MAINTENANCE AND MINOR REPAIR

EAU23730

## Replacing a headlight bulb

This model is equipped with two quartz bulb headlights. If a headlight bulb burns out, replace it as follows.

1. Remove cowling B. (See page 6-7.)
2. Disconnect the headlight coupler, and then remove the bulb cover.

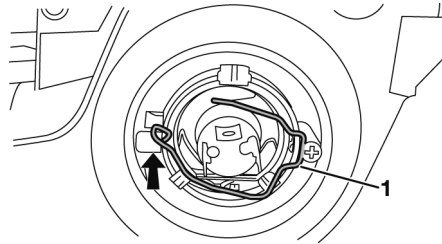

1. Headlight bulb holder

EWA10790

### **WARNING**

Headlight bulbs get very hot. Therefore, keep flammable products away from a lit headlight bulb, and do not touch the bulb until it has cooled down.

4. Place a new headlight bulb into position, and then secure it with the bulb holder.

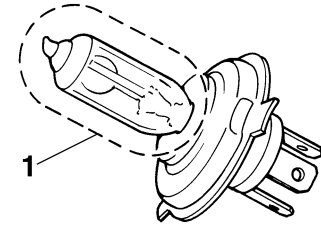

1. Do not touch the glass part of the bulb

ECA10650

### **CAUTION:**

Take care not to damage the following parts:

- **Headlight bulb**

Do not touch the glass part of the headlight bulb to keep it free from oil, otherwise the transparency of the glass, the luminosity of the bulb, and the bulb life will be adversely affected. Thoroughly clean off any dirt and fingerprints on the headlight bulb using a cloth moistened with alcohol or thinner.

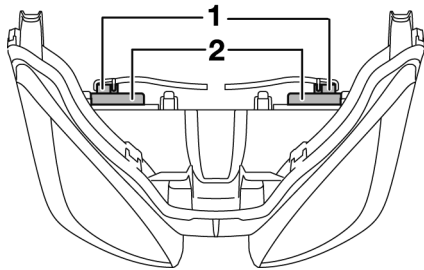

1. Headlight coupler
2. Headlight bulb cover

3. Unhook the headlight bulb holder, and then remove the defective bulb.

# PERIODIC MAINTENANCE AND MINOR REPAIR

## ● Headlight lens

- Do not affix any type of tinted film or stickers to the headlight lens.
  - Do not use a headlight bulb of a wattage higher than specified.
- 
5. Install the headlight bulb cover, and then connect the coupler.
  6. Install the cowling.
  7. Have a Yamaha dealer adjust the headlight beam if necessary.

EAU24240

## Replacing a front turn signal light bulb

1. Place the scooter on the centers-stand.
2. Remove cowling A. (See page 6-7.)
3. Remove the socket (together with the turn signal light bulb) by turning it counterclockwise.

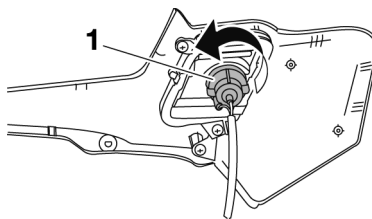

1. Turn signal light bulb socket

4. Remove the defective bulb by pushing it in and turning it counterclockwise.
5. Insert a new bulb into the socket, push it in, and then turn it clockwise until it stops.
6. Install the socket (together with the bulb) by turning it clockwise.
7. Install the cowling.

EAU1440

## Replacing a tail/brake light bulb or a rear turn signal light bulb

1. Place the scooter on the centers-stand.
2. Open the seat, and then remove the rear storage compartment. (See page 3-14.)

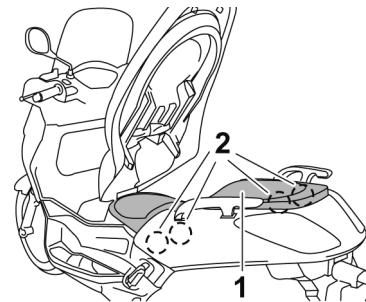

1. Rear storage compartment
2. Bolt

3. Remove the tail/brake light and turn signal light bulb holder by pulling it outward.

# PERIODIC MAINTENANCE AND MINOR REPAIR

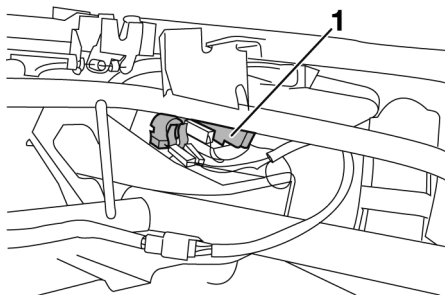

1. Bulb socket

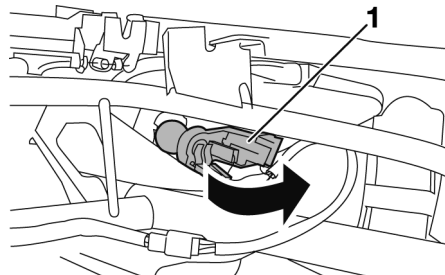

1. Remove

4. Remove the defective bulb by pushing it in and turning it counterclockwise.

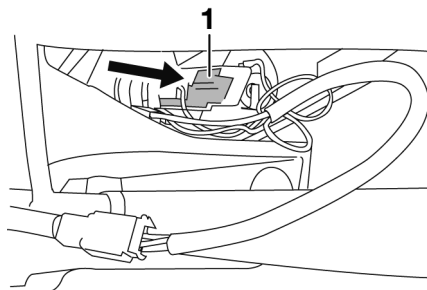

1. Push

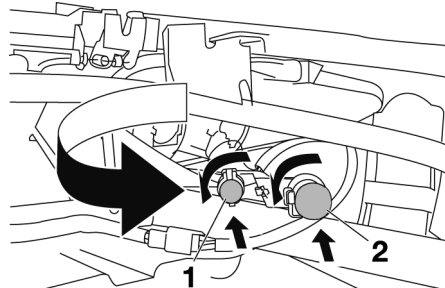

1. Turn signal light bulb
2. Tail/brake light bulb

5. Insert a new bulb into the socket by pushing it in and turning it clockwise.
6. Install the bulb holder by pushing it into the original position.
7. Install the rear storage compartment, and then close the seat.



## Replacing the license plate light bulb

1. Remove the socket (together with the bulb) by pulling it out.

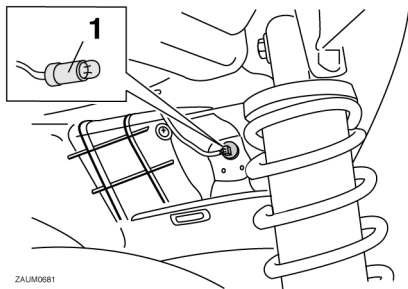

1. License plate light unit

2. Remove the defective bulb by pulling it out.
3. Insert a new bulb into the socket.
4. Install the socket (together with the bulb) by pushing it in.

## Replacing an auxiliary light bulb

This model is equipped with two auxiliary lights. If an auxiliary light bulb burns out, replace it as follows.

1. Remove the cowling B.
2. Remove the socket (together with the bulb) by pulling it out.

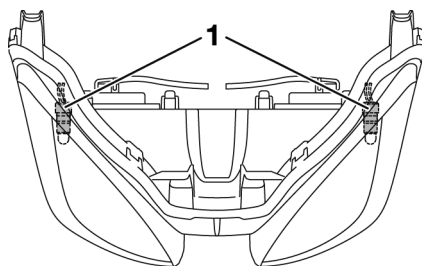

1. Auxiliary light bulb socket

3. Remove the defective bulb by pulling it out.
4. Insert a new bulb into the socket.
5. Install the socket (together with the bulb) by pushing it in.
6. Install the cowling B.

## Troubleshooting

Although Yamaha scooters receive a thorough inspection before shipment from the factory, trouble may occur during operation. Any problem in the fuel, compression, or ignition systems, for example, can cause poor starting and loss of power.

The following troubleshooting charts represent quick and easy procedures for checking these vital systems yourself. However, should your scooter require any repair, take it to a Yamaha dealer, whose skilled technicians have the necessary tools, experience, and know-how to service the scooter properly.

Use only genuine Yamaha replacement parts. Imitation parts may look like Yamaha parts, but they are often inferior, have a shorter service life and can lead to expensive repair bills.

# PERIODIC MAINTENANCE AND MINOR REPAIR

EAU42130

## Troubleshooting charts

### Starting problems or poor engine performance

EWA10840

#### **⚠ WARNING**

**Keep away open flames and do not smoke while checking or working on the fuel system.**

#### 1. Fuel

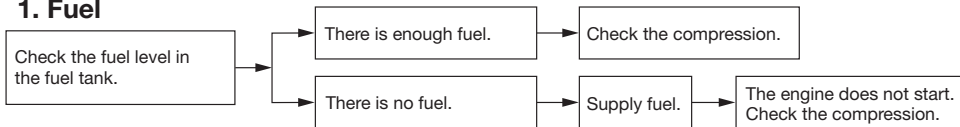

#### 2. Compression

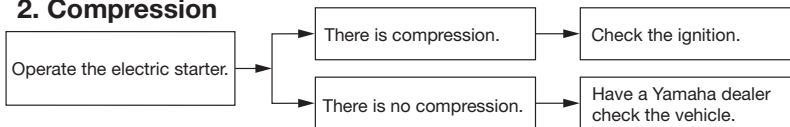

#### 3. Ignition

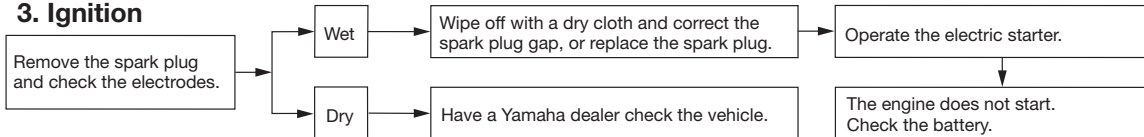

#### 4. Battery

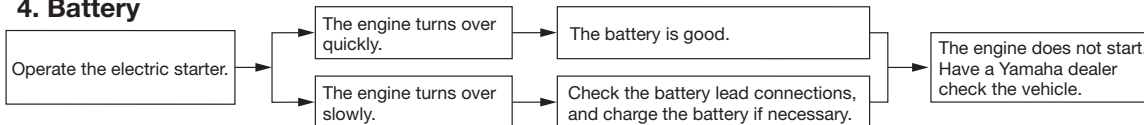

6

# PERIODIC MAINTENANCE AND MINOR REPAIR

## Engine overheating

EWA10400

### **⚠ WARNING**

- Do not remove the radiator cap when the engine and radiator are hot. Scalding hot fluid and steam may be blown out under pressure, which could cause serious injury. Be sure to wait until the engine has cooled.
- After removing the radiator cap retaining bolt, place a thick rag, like a towel, over the radiator cap, and then slowly rotate the cap counterclockwise to the detent to allow any residual pressure to escape. When the hissing sound has stopped, press down on the cap while turning it counterclockwise, and then remove the cap.

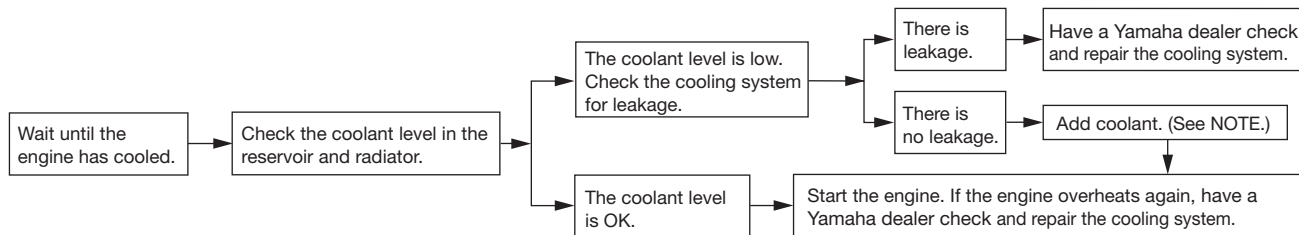

### **NOTE:**

If coolant is not available, tap water can be temporarily used instead, provided that it is changed to the recommended coolant as soon as possible.

# SCOOTER CARE AND STORAGE

---

EAU26091

## Care

While the open design of a scooter reveals the attractiveness of the technology, it also makes it more vulnerable. Rust and corrosion can develop even if high-quality components are used. A rusty exhaust pipe may go unnoticed on a car, however, it detracts from the overall appearance of a scooter. Frequent and proper care does not only comply with the terms of the warranty, but it will also keep your scooter looking good, extend its life and optimize its performance.

### Before cleaning

1. Cover the muffler outlet with a plastic bag after the engine has cooled down.
2. Make sure that all caps and covers as well as all electrical couplers and connectors, including the spark plug cap, are tightly installed.
3. Remove extremely stubborn dirt, like oil burnt onto the crankcase, with a degreasing agent and a brush, but never apply such pro-

ducts onto seals, gaskets and wheel axles. Always rinse the dirt and degreaser off with water.

### Cleaning

ECA10781

#### CAUTION:

- **Avoid using strong acidic wheel cleaners, especially on spoked wheels. If such products are used on hard-to-remove dirt, do not leave the cleaner on the affected area any longer than instructed. Also, thoroughly rinse the area off with water, immediately dry it, and then apply a corrosion protection spray.**
- **Improper cleaning can damage plastic parts such as cowlings, panels, windshields, headlight lenses, meter lenses, etc. Use only a soft, clean cloth or sponge with mild detergent and water to clean plastic.**
- **Do not use any harsh chemical products on plastic parts. Be sure to avoid using cloths or sponges which have been in contact with strong or abrasive**

**cleaning products, solvent or thinner, fuel (gasoline), rust removers or inhibitors, brake fluid, antifreeze or electrolyte.**

- **Do not use high-pressure washers or steam-jet cleaners since they cause water seepage and deterioration in the following areas: seals (of wheel and swingarm bearings, fork and brakes), electric components (couplers, connectors, instruments, switches and lights), breather hoses and vents.**
  - **For scooters equipped with a windshield: Do not use strong cleaners or hard sponges as they will cause dulling or scratching. Some cleaning compounds for plastic may leave scratches on the windshield. Test the product on a small hidden part of the windshield to make sure that it does not leave any marks. If the windshield is scratched, use a quality plastic polishing compound after washing.**
-

# SCOOTER CARE AND STORAGE

## After normal use

Remove dirt with warm water, a mild detergent, and a soft, clean sponge, and then rinse thoroughly with clean water. Use a toothbrush or bottle-brush for hard-to-reach areas. Stubborn dirt and insects will come off more easily if the area is covered with a wet cloth for a few minutes before cleaning.

## After riding in the rain, near the sea or on salt-sprayed roads

Since sea salt or salt sprayed on the roads during winter are extremely corrosive in combination with water, carry out the following steps after each ride in the rain, near the sea or on salt-sprayed roads.

## **NOTE:**

Salt sprayed on roads in the winter may remain well into spring.

1. Clean the scooter with cold water and a mild detergent after the engine has cooled down.

ECA10790

## **CAUTION:**

**Do not use warm water since it increases the corrosive action of the salt.**

2. Apply a corrosion protection spray on all metal, including chrome- and nickel-plated, surfaces to prevent corrosion.

## **After cleaning**

1. Dry the scooter with a chamois or an absorbing cloth.
2. Use a chrome polish to shine chrome, aluminum and stainless-steel parts, including the exhaust system. (Even the thermally induced discoloring of stainless-steel exhaust systems can be removed through polishing.)
3. To prevent corrosion, it is recommended to apply a corrosion protection spray on all metal, including chrome- and nickel-plated, surfaces.
4. Use spray oil as a universal cleaner to remove any remaining dirt.
5. Touch up minor paint damage caused by stones, etc.

6. Wax all painted surfaces.
7. Let the scooter dry completely before storing or covering it.

EWA10940

## **⚠ WARNING**

- **Make sure that there is no oil or wax on the brakes or tires. If necessary, clean the brake discs and brake linings with a regular brake disc cleaner or acetone, and wash the tires with warm water and a mild detergent.**
- **Before operating the scooter test its braking performance and cornering behavior.**

ECA10800

## **CAUTION:**

- **Apply spray oil and wax sparingly and make sure to wipe off any excess.**
- **Never apply oil or wax to any rubber and plastic parts, but treat them with a suitable care product.**
- **Avoid using abrasive polishing compounds as they will wear away the paint.**

# SCOOTER CARE AND STORAGE

---

**NOTE:** \_\_\_\_\_  
Consult a Yamaha dealer for advice  
on what products to use.  
\_\_\_\_\_

EAU36560

## Storage Short-term

Always store your scooter in a cool, dry place and, if necessary, protect it against dust with a porous cover.

ECA10820

## CAUTION:

- **Storing the scooter in a poorly ventilated room or covering it with a tarp, while it is still wet, will allow water and humidity to seep in and cause rust.**
- **To prevent corrosion, avoid damp cellars, stables (because of the presence of ammonia) and areas where strong chemicals are stored.**

---

## Long-term

Before storing your scooter for several months:

1. Follow all the instructions in the “Care” section of this chapter.
2. Fill up the fuel tank and add fuel stabilizer (if available) to prevent the fuel tank from rusting and the fuel from deteriorating.

3. Perform the following steps to protect the cylinder, piston rings, etc. from corrosion.
  - a. Remove the spark plug cap and spark plug.
  - b. Pour a teaspoonful of engine oil into the spark plug bore.
  - c. Install the spark plug cap onto the spark plug, and then place the spark plug on the cylinder head so that the electrodes are grounded. (This will limit sparking during the next step.)
  - d. Turn the engine over several times with the starter. (This will coat the cylinder wall with oil.)
  - e. Remove the spark plug cap from the spark plug, and then install the spark plug and the spark plug cap.

EWA10950

## **WARNING**

**To prevent damage or injury from sparking, make sure to ground the spark plug electrodes while turning the engine over.**

---

4. Lubricate all control cables and the pivoting points of all levers and pedals as well as of the sidestand/centerstand.
5. Check and, if necessary, correct the tire air pressure, and then lift the scooter so that both of its wheels are off the ground. Alternatively, turn the wheels a little every month in order to prevent the tires from becoming degraded in one spot.
6. Cover the muffler outlet with a plastic bag to prevent moisture from entering it.
7. Remove the battery and fully charge it. Store it in a cool, dry place and charge it once a month. Do not store the battery in an excessively cold or warm place [less than 0 °C (30 °F) or more than 30 °C (90 °F)]. For more information on storing the battery, see page 6-26.

EAU37833

## Matte color caution

ECA15192

### **CAUTION:**

**Some models are equipped with matte colored finished parts. Be sure to consult a Yamaha dealer for advice on what products to use before cleaning the vehicle. Using a brush, harsh chemical products or cleaning compounds when cleaning these parts will scratch or damage their surface. Wax also should not be applied to any matte colored finished parts.**

---

**NOTE:** \_\_\_\_\_  
Make any necessary repairs before storing the scooter.

---

# SPECIFICATIONS

## Dimensions:

Overall length:  
2210 mm (87.0 in)  
Overall width:  
790 mm (31.1 in)  
Overall height:  
1380 mm (54.3 in)  
Seat height:  
785 mm (30.9 in)  
Wheelbase:  
1545 mm (60.8 in)  
Ground clearance:  
112 mm (4.44 in)  
Minimum turning radius:  
3650 mm (143.7 in)

## Weight:

With oil and fuel:  
166 kg (366 lb)

## Engine:

Engine type:  
Liquid cooled 4-stroke, SOHC  
Cylinder arrangement:  
Forward-inclined single cylinder  
Displacement:  
124.6 cm<sup>3</sup>  
Bore x stroke:  
52.0 x 58.6 mm (2.05 x 2.31 in)  
Compression ratio:  
11.20 :1  
Starting system:  
Electric starter  
Lubrication system:  
Wet sump

## Engine oil:

Type:  
SAE 10W-30, SAE 10W-40, SAE 15W-40,  
SAE 20W-40 or SAE 20W-50

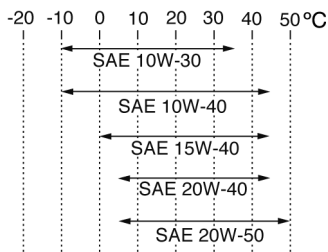

Recommended engine oil grade:  
API service SG type or higher, JASO  
standard MA

Engine oil quantity:  
Without oil filter cartridge replacement:  
1.40 L (1.48 US qt) (1.23 Imp.qt)  
With oil filter element replacement:  
1.50 L (1.59 US qt) (1.32 Imp.qt)

## Final transmission oil:

Type:  
SAE 10W-30 type SE motor oil  
Quantity:  
0.21 L (0.22 US qt) (0.18 Imp.qt)

## Cooling system:

Coolant reservoir capacity (up to the  
maximum level mark):  
0.26 L (0.27 US qt) (0.23 Imp.qt)

Radiator capacity (including all routes):  
1.40 L (1.48 US qt) (1.23 Imp.qt)

## Air filter:

Air filter element:  
Oil-coated paper element

## Fuel:

Recommended fuel:  
Regular unleaded gasoline only  
Fuel tank capacity:  
12.5 L (3.30 US gal) (2.75 Imp.gal)  
Fuel reserve amount:  
2 L (0.53 US gal) (0.44 Imp.gal)

## Throttle body:

Type/quantity:  
EFI (1B9) / 1  
Manufacturer:  
AISAN

## Spark plug (s):

Manufacturer/model:  
NGK/ CPR 9EA-9  
Spark plug gap:  
0.8-0.9 mm (0.031-0.035 in)

## Clutch:

Clutch type:  
Dry, centrifugal automatic

## Transmission:

Primary reduction system:  
Helical gear  
Primary reduction ratio:  
41/14 (2.929)  
Secondary reduction system:  
Helical gear  
Secondary reduction ratio:  
44/13 (3.384)



Transmission type:  
V-belt automatic

## Chassis:

Frame type:  
Steel tube underbone  
Caster angle:  
28.00 degree

Trail:  
100.0 mm (3.94 in)

## Front tire:

Type:  
Tubeless  
Size:  
120/70-15 M/C 56S(Michelin -  
Continental)  
120/70-15 M/C 56P(Pirelli)

Manufacturer/model:  
Michelin/GoldStandard  
Manufacturer/model:  
Continental/ContiTwist TL  
Manufacturer/model:  
Pirelli/GTS23

## Rear tire:

Type:  
Tubeless  
Size:  
140/70-14 M/C 68S(Michelin -  
Continental)  
140/70-14 M/C 68P(Pirelli)

Manufacturer/model:  
Michelin/GoldStandard  
Manufacturer/model:  
Continental/ContiTwist TL  
Manufacturer/model:  
Pirelli/GTS24

## Loading:

Maximum load:  
189 kg (417 lb)

(Total weight of rider, passenger, cargo  
and accessories)

## Tire air pressure (measured on cold tires):

Loading condition:  
0-90 kg  
Front:  
190 kPa (28 psi) (1.90 kgf/cm<sup>2</sup>) (1.90 bar)

Rear:  
220 kPa (32 psi) (2.20 kgf/cm<sup>2</sup>) (2.20 bar)

Loading condition:  
90 kg - maximum load

Front:  
210 kPa (30 psi) (2.10 kgf/cm<sup>2</sup>) (2.10 bar)

Rear:  
250 kPa (36 psi) (2.50 kgf/cm<sup>2</sup>) (2.50 bar)

High-speed riding:  
Front:  
210 kPa (30 psi) (2.10 kgf/cm<sup>2</sup>) (2.10 bar)

Rear:  
250 kPa (36 psi) (2.50 kgf/cm<sup>2</sup>) (2.50 bar)

## Front wheel:

Wheel type:  
Cast wheel  
Rim size:  
15 x MT3.5

## Rear wheel:

Wheel type:  
Cast wheel  
Rim size:  
14 x MT3.75

## Front brake:

Type:  
Single disc brake  
Operation:  
Right hand operation  
Recommended fluid:  
DOT 4

## Rear brake:

Type:  
Single disc brake  
Operation:  
Left hand operation  
Recommended fluid:  
DOT 4

## Front suspension:

Type:  
Telescopic fork  
Spring/shock absorber type:  
Coil spring/oil damper  
Wheel travel:  
94.0 mm (3.70 in)

## Rear suspension:

Spring/shock absorber type:  
Coil spring/oil damper  
Wheel travel:  
83.0 mm (3.27 in)

## Electrical system:

Ignition system:  
Transistorized coil ignition (digital)  
Charging system:  
AC magneto

## Battery:

Model:  
YTX9-BS

# SPECIFICATIONS

---

Voltage, capacity:

12 V, 8.0 Ah

## Headlight:

Bulb type:

Halogen bulb

Bulb voltage, wattage x quantity:

Headlight:

12 V, 35 W/35.0 W x 2

Tail/brake light:

12 V, 21.0 W/5.0 W x 2

Front turn signal light:

12 V, 10.0 W x 2

Rear turn signal light:

12 V, 10.0 W x 2

Auxiliary light:

12 V, 5.0 W x 2

License plate light:

12 V, 5.0 W x 1

Meter lighting:

LED

High beam indicator light:

LED x 1

Turn signal indicator light:

LED x 2

Engine trouble warning light:

LED x 1

Immobilizer system indicator light:

LED x 1

## Fuses:

Main fuse:

30.0 A

Headlight fuse:

15.0 A

Signaling system fuse:

15.0 A

Ignition fuse:

10.0 A

Radiator fan fuse:

10.0 A

ECU (Electronic Control Unit) fuse:

5.0 A

Backup fuse:

5.0 A

EAU26351

EAU26381

EAU26410

## Identification numbers

Record the key identification number, vehicle identification number and model label information in the spaces provided below for assistance when ordering spare parts from a Yamaha dealer or for reference in case the vehicle is stolen.

KEY IDENTIFICATION NUMBER:

VEHICLE IDENTIFICATION NUMBER:

MODEL LABEL INFORMATION:

## Key identification number

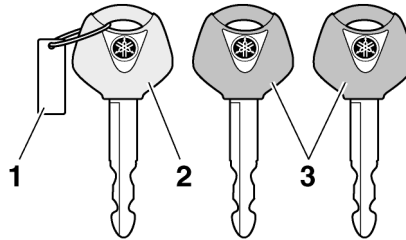

1. Key identification number
2. Code re-registering key (red bow)
3. Standard keys (black bow)

The key identification number is stamped into the key tag. Record this number in the space provided and use it for reference when ordering a new key.

## Vehicle identification number

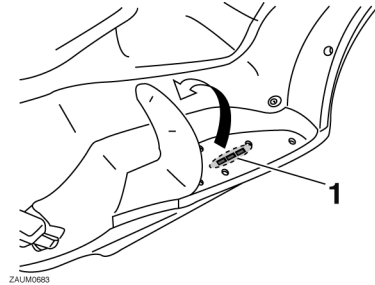

1. Vehicle identification number

The vehicle identification number is stamped into the frame.

**NOTE:** \_\_\_\_\_  
The vehicle identification number is used to identify your scooter and may be used to register your scooter with the licensing authority in your area.

# CONSUMER INFORMATION

---

EAU26490

## Model label

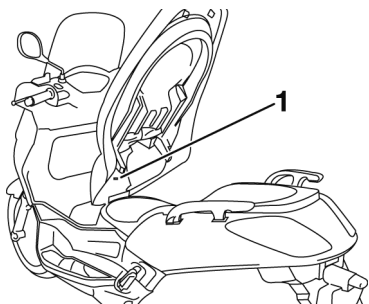

### 1. Model label

The model label is affixed to the bottom of the seat. (See page 3-14.) Record the information on this label in the space provided. This information will be needed when ordering spare parts from a Yamaha dealer.

- A**
- Acceleration and deceleration .....5-2
  - Air filter and V-belt case air filter elements .....6-15
  - Anti-theft alarm (optional) .....3-9
  - Auxiliary light bulb, replacing .....6-32
- B**
- Battery .....6-26
  - Brake fluid level, checking .....6-21
  - Brake fluid, changing .....6-22
  - Brake lever, front .....3-10
  - Brake lever, rear .....3-11
  - Brake levers, lubricating .....6-23
  - Braking .....5-3
- C**
- Cables, checking and lubricating .....6-23
  - Care .....7-1
  - Catalytic converters .....3-13
  - Centerstand and sidestand, checking and lubricating .....6-24
  - Coolant .....6-14
  - Coolant temperature gauge .....3-5
  - Cowlings and panel, removing and installing .....6-7
- D**
- Dimmer switch .....3-9
  - Display, multi-function .....3-6
- E**
- Engine break-in .....5-4
  - Engine oil .....6-10
  - Engine trouble warning light .....3-3
- F**
- Final transmission oil .....6-13
  - Front and rear brake lever free play .....6-20
- Front and rear brake pads, checking .....6-21
  - Front fork, checking .....6-24
  - Fuel .....3-12
  - Fuel consumption, tips for reducing .....5-3
  - Fuel gauge .....3-5
  - Fuel level warning light .....3-3
  - Fuel tank cap .....3-11
  - Fuses, replacing .....6-27
- H**
- Handlebar switches .....3-9
  - Hazard switch .....3-9
  - Headlight bulb, replacing .....6-29
  - High beam indicator light .....3-3
  - Horn switch .....3-9
- I**
- Identification numbers .....9-1
  - Ignition circuit cut-off system .....3-18
  - Immobilizer system .....3-1
  - Immobilizer system indicator light .....3-3
  - Indicator and warning lights .....3-3
- K**
- Key identification number .....9-1
- L**
- License plate light bulb, replacing .....6-32
- M**
- Main switch/steering lock .....3-2
  - Matte color, caution .....7-4
  - Model label .....9-2
- P**
- Parking .....5-4
  - Part locations .....2-1
  - Periodic maintenance and lubrication chart .....6-3
  - Pre-operation check list .....4-2
- S**
- Safe-riding points .....1-1
  - Safety information .....1-1
  - Seat .....3-14
  - Self-diagnosis device .....3-4
  - Shock absorber assemblies, adjusting .....3-17
  - Sidestand .....3-18
  - Spark plug, checking .....6-9
  - Specifications .....8-1
  - Speedometer .....3-4
  - Start switch .....3-9
  - Starting off .....5-2
  - Starting the engine .....5-1
  - Steering, checking .....6-25
  - Storage .....7-3
  - Storage compartment (front) .....3-15
  - Storage compartment (rear) .....3-16
  - Storage compartments .....3-14
- T**
- Tail/brake light bulb or rear turn signal light bulb, replacing .....6-30
  - Throttle cable free play, adjusting .....6-17
  - Throttle grip and cable, checking and lubricating .....6-23
  - Tires .....6-18
  - Tool kit .....6-1
  - Troubleshooting .....6-32
  - Troubleshooting charts .....6-33
  - Turn signal indicator lights .....3-3
  - Turn signal light bulb (front), replacing .....6-30
  - Turn signal switch .....3-9
- V**
- Valve clearance .....6-17
  - Vehicle identification number .....9-1

# INDEX

---

---

## W

|                               |      |
|-------------------------------|------|
| Wheel bearings, checking..... | 6-26 |
| Wheels .....                  | 6-20 |





PRINTED IN THE NETHERLANDS  
2007.11  
(E)